

# *Proceedings of the West Africa Built Environment Research (WABER) Conference 2021*

Book

Published Version

Conference Proceedings

Laryea, Sam and Essah, Emmanuel ORCID logoORCID:  
<https://orcid.org/0000-0002-1349-5167>, eds. (2021)  
Proceedings of the West Africa Built Environment Research  
(WABER) Conference 2021. West Africa Built Environment  
Research (WABER) Conference, pp1059. ISBN  
9780620953672 Available at  
<https://centaur.reading.ac.uk/103974/>

It is advisable to refer to the publisher's version if you intend to cite from the work. See [Guidance on citing](#).

Published version at: <http://waberconference.com>

Publisher: West Africa Built Environment Research (WABER) Conference

All outputs in CentAUR are protected by Intellectual Property Rights law, including copyright law. Copyright and IPR is retained by the creators or other copyright holders. Terms and conditions for use of this material are defined in the [End User Agreement](#).

[www.reading.ac.uk/centaur](http://www.reading.ac.uk/centaur)

**CentAUR**

Central Archive at the University of Reading

Reading's research outputs online



# PROCEEDINGS OF THE

# WABER 2021 CONFERENCE

WEST AFRICA BUILT ENVIRONMENT RESEARCH CONFERENCE

WWW.WABERCONFERENCE.COM

KNOWLEDGE, INTERACTION, PEOPLE & LEADERSHIP



**9-11 AUGUST**

Labadi Beach Hotel  
Accra, Ghana

ISBN 978-0-620-95367-2

EDITORS: S. LARYEA AND E. ESSAH



WEST AFRICA BUILT ENVIRONMENT RESEARCH (WABER) CONFERENCE  
*Knowledge, Interaction, People & Leadership*

**PROCEEDINGS OF THE  
WABER 2021 CONFERENCE**  
9<sup>th</sup>-11<sup>th</sup> August 2021  
Accra, Ghana

**EDITORS**

**Sam Laryea**  
Wits University, South Africa

**Emmanuel Adu Essah**  
University of Reading, United Kingdom



Proceedings of the West Africa Built Environment Research (WABER) Conference 2021

9<sup>th</sup> – 11<sup>th</sup> August 2021

Labadi Beach Hotel, Accra, Ghana

© Copyright. WABER Conference.

The copyright for papers in this publication belongs to authors of the papers. Refer to copyright statement in publication for more details

ISBN 978-0-620-95367-2

The ISBN for this publication was provided by the National Library of South Africa. Legal deposits of the publication have been supplied to the National Library of South Africa, Library of Parliament, and other places of Legal Deposit.

First published in August 2021

Published by:

West Africa Built Environment Research (WABER) Conference

C/o Prof Sam Laryea

School of Construction Economics and Management

University of the Witwatersrand

1 Jan Smuts Avenue, Johannesburg, South Africa

Tel: +233 545 204 300 / +27 78 172 6106

Email: info@waberconference.com / samuel.laryea@wits.ac.za

Website: www.waberconference.com

Editors

Sam Laryea, Wits University, South Africa

Emmanuel Adu Essah, University of Reading, United Kingdom

Cover design by MPDPS Pty Ltd

Declaration

All papers in this publication have been through a review process involving initial screening of abstracts, review of full papers by at least two referees, reporting of comments to authors, revision of papers by authors and re-evaluation of re-submitted papers to ensure quality of content.

# TABLE OF CONTENTS

Table of Contents	iii
Foreword	v
Copyright Statement	vii
Peer Review and Scientific Publishing Statement	ix
Peer Review Panel	xi
Prizes to be awarded at the WABER Conference 2021	xiii
Programme and Profile of Speakers for WABER 2021 Conference	xv
List of Papers in WABER 2021 Conference Proceedings	xvii
Conference Papers	21
Index of Authors	1077
Index of Keywords	1081



**NEA ONNIM NO SUA A, OHU**

***"He who does not know can know from learning"***

This is the Adinkra symbol of knowledge, life-long education and continued quest for knowledge. The Akan people in West Africa believe that the search for knowledge is a life-long process. This is evident from the Akan saying "Nea onnim sua a, ohu; nea odwen se onim dodo no, se ogyae sua a, ketewa no koraa a onim no firi ne nsa" which translates into "He who does not know can become knowledgeable from learning; he who thinks he knows and ceases to continue to learn will stagnate".

## FOREWORD

I would like to welcome each participant to the WABER 2021 Conference. Since its inception in 2009, the WABER Conference series has done a great deal to nurture and support researchers, initially in West Africa, also, in other parts of Africa and elsewhere. I would like to thank all delegates for your participation which enables us to keep this Conference going.

The WABER Conference enjoys a positive international reputation and has continued to grow from strength to strength over the past 13 years. For this, I would like to thank our team, keynote speakers and participants over the years for every contribution you have made to the success of this Conference. This year's Conference has an excellent programme, line up of speakers and authors.

I would like to thank and commend the authors of all 72 papers in this Conference proceedings. If the research paper writing process was compared to a marathon, the authors of the 72 papers in this publication would be adjudged as the ones who have endured and finished the race.

We opened the call for papers for this Conference in December 2020 and over 100 abstracts were submitted by authors. However, it is one thing to propose to write a paper, and it is quite another thing to actually write the paper. Therefore, I would like to thank and congratulate all authors who succeeded in completing the process of getting published in this conference proceedings.

It is befitting that we have an excellent range of interesting topics in the 72 papers to be discussed at this conference.

We are honoured to welcome Professor Charles Egbu, Vice Chancellor of Leeds Trinity University, to give us a special opening address.

In the three days of this conference, we will have various plenary presentations by experienced international academics and I would like to thank and welcome each of them below.

Professor Albert Chan  
Richard Lorch  
Professor Taibat Lawanson  
Professor Dato' Sri Ar Dr Asiah Abdul Rahim  
Professor George Ofori

In addition to these speakers, we have other interesting sessions on the programme including a special session for doctoral students and supervisors several other experienced speakers addressing various topics that should be of interest to many of us.

I would like to thank all members of the organising team particularly Associate Professor Emmanuel Essah, Dr Yakubu Aminu Dodo and Dr Sam Moveh for their efforts which has helped to organise this Conference successfully. I would also like to thank all of our reviewers particularly Associate Professor Emmanuel Essah and Dr Haruna Moda for the considerable time and effort spent reviewing and checking all papers to ensure a high standard of quality.

The WABER Conference Team always plays an excellent role in the success of our events and I would like to thank and appreciate the contributions of Florence, Sam Boakye, Victor Ayitey and his team, Kwesi Kwofie and Issah Abdul Rahman to the success of this Conference.

I hope you enjoy our first hybrid conference and engage with our exciting speakers on the diverse topics that will be covered over the three days of this Conference.

Sam Laryea  
University of the Witwatersrand, Johannesburg, South Africa  
Chairman of WABER Conference  
August 2021

## COPYRIGHT STATEMENT

The copyright for papers published in the WABER Conference Proceedings belongs to authors of the papers.

Authors may reproduce and distribute papers published in the WABER Conference Proceedings for personal and educational purposes without written permission but with a citation to this source. No unauthorised reproduction or distribution, in whole or in part, of work published in the WABER Conference Proceedings by persons other than authors is allowed without the written permission of authors or organisers of the WABER Conference, whichever is applicable.

All authors of papers published in the WABER Conference Proceedings retain the right to re-publish their work in any format without the need for further permission from organisers of the WABER Conference. This includes making copies the final published pdf version of papers available on personal websites and institutional repositories and bibliographic databases. However, we ask authors to acknowledge that the original paper was first published by WABER Conference as part of the Conference Proceedings.

We have taken reasonable steps to comply with copyright obligations in the production of this Conference Proceedings. However, we make no warranties or representations that material contained in the papers written by authors does not infringe the intellectual property rights of any person anywhere in the world.

We do not authorise infringement of copyrights / intellectual property rights by authors. If you believe that any material in any paper published in this Conference Proceedings has been inappropriately used, please contact us by email: [info@waberconference.com](mailto:info@waberconference.com)

Our authors are responsible for ensuring good academic practice when conducting and reporting scientific research. It is the responsibility of authors to abide by the norms of academic ethics and integrity. WABER Conference accepts no liability for copyright infringements or inappropriate use of material in any paper published.

Correspondence relating to copyrights / intellectual property rights or requests for permission to use material from the WABER Conference Proceedings should be made to the Chairman of WABER Conference by email: [info@waberconference.com](mailto:info@waberconference.com)



# PEER REVIEW AND SCIENTIFIC PUBLISHING STATEMENT



9<sup>th</sup> August 2021

## TO WHOM IT MAY CONCERN

The scientific information published in peer-reviewed outlets carries special status, and confers unique responsibilities on editors and authors. We must protect the integrity of the scientific process by publishing only manuscripts that have been properly peer-reviewed by scientific reviewers and confirmed by editors to be of sufficient quality.

I confirm that all papers in the WABER 2021 Conference Proceedings have been through a peer review process involving initial screening of abstracts, review of full papers by at least two referees, reporting of comments to authors, revision of papers by authors, and re-evaluation of re-submitted papers to ensure quality of content.

It is the policy of the West Africa Built Environment Research (WABER) Conference that all papers must go through a systematic peer review process involving examination by at least two referees who are knowledgeable on the subject. A paper is only accepted for publication in the conference proceedings based on the recommendation of the reviewers and decision of the editors.

The names and affiliation of members of the Scientific Committee & Review Panel for WABER 2021 Conference are published in the Conference Proceedings and on our website [www.waberconference.com](http://www.waberconference.com)

Papers in the WABER Conference Proceedings are published open access on the conference website [www.waberconference.com](http://www.waberconference.com) to facilitate public access to the research papers and wider dissemination of the scientific knowledge.

Yours Sincerely,

A handwritten signature in black ink, appearing to read 'Sam Laryea', with a horizontal line underneath.

Sam Laryea, PhD  
Chairman of WABER Conference

## PEER REVIEW PANEL

WABER Conference is very grateful to each the following persons for your contribution to the peer review process. Thank you so much.

A/Prof Samuel Laryea, Wits University, South Africa  
A/Prof Emmanuel A. Essah, University of Reading, UK  
A/Prof Carmel Margaret Lindkvist , Norwegian University of Science and Technology, Norway  
A/Prof Ian Ewart, University of Reading, UK  
A/Prof Joy Maina, Ahmadu Bello University, Nigeria  
A/Prof Obinna Ozumba, University of the Witwatersrand, South Africa  
Dr Adwoa Serwaa Ofori, Trinity College Dublin, Ireland  
Dr Afolabi Dania, University of Westminster, UK  
Dr Amna Shibeika, United Arab Emirates University  
Dr Amos Darko, The Hong Kong Polytechnic University, Hong Kong  
Dr Bruno Lot Tanko, University of Reading Malaysia, Malaysia  
Dr Chiahemba J. Nor, Department of Parks and Recreational, Nigeria  
Dr. Ing. Collins Ameyaw, Kumasi Technical University, Ghana  
Dr Cynthia Adeokun, O. N. A. Architects Ltd, UK  
Dr Dave Collins, Norwegian University of Science and Technology, Norway  
Dr Erekpitan Ola-Adisa, University of Jos, Nigeria  
Dr Faizah Bashir, University of Hail, Saudi Arabia  
Dr Folake Ekundayo, Architect at Berkshire Healthcare NHS Foundation Trust, UK  
Dr Gabriel Nani, Kwame Nkrumah University of Science and Technology, Ghana  
Dr Hafizah Latif, Universiti Teknologi MARA (Perak), Malaysia  
Dr Haruna Moda, Manchester Metropolitan University, UK  
Dr Humphrey Danso, Akenten Appiah-Menka University of Skills Training & Entrepreneurial Development, Ghana  
Dr Immanuel Darkwa, Trinity College Dublin, Ireland  
Dr Kwadwo Oti-Sarpong, University of Cambridge, UK  
Dr Eng L. Ofetotse, Kingston University, UK  
Dr Lawrence Mbugua, University of Reading, UK  
Dr Mehdi Shahrestani, University of Reading, UK  
Dr Naa Adjeley Ashiboe-Mensah Doamekpor, University of Professional Studies, Accra  
Dr Nimlyat S. Pontip, University of Jos, Nigeria  
Dr Ogunbode Ezekiel Babatunde, Federal University of Technology Minna, Nigeria  
Dr Philippa Boyd, University of Reading, UK  
Dr Prince Senyo, University of Southampton, UK  
Dr Ron Watermeyer, Infrastructure Options (Pty),Ltd, South Africa  
Dr Ronan Champion, University of Reading, UK  
Dr Sarfo Mensah, Kumasi Technical University, Ghana  
Dr Selorm Adukpo, Oxford Brookes University, UK  
Dr Seyi Odeyale, University of Ibadan, Nigeria  
Dr Sherif Razak, University of Salford, UK  
Dr Sitsabo Dlamini, Wits University, South Africa  
Dr Wallace Imoudu Enegbuma, Victoria University of Wellington, New Zealand  
Dr. Yakubu Aminu Dodo, Istanbul Gelisim University, Turkey

# PRIZES TO BE AWARDED AT THE WABER 2021 CONFERENCE

- **Best Research Paper**

This prize is awarded to recognize the author(s) of an original piece of research which contributes a better understanding of the research question/problem investigated and demonstrates a high degree of scientific quality and innovative thought. This prize was created to acknowledge the continuing importance of high quality research to academic institutions, a researcher's reputation and the development of the built environment field.

- **Best Oral Presentation**

This prize is awarded to recognise the presentation which is the most coherent, clearly enunciated, well-paced, easy to understand, and effective. The award is given on the basis of quality of the presentation and not the written paper. It recognizes the best presentation based on communication of the content of a paper and the ability of the speaker to deliver an impactful, authoritative and engaging presentation. The award looks to encourage researchers to put as much effort as possible into the presentation of their work.

- **Gibrine Adam Promising Young Scholar Award**

This prize is awarded to recognize and encourage exceptional young researchers. The recipient should be a young academic who demonstrates promise, such that he/she is likely to become established as a research leader. The prize is provided by Mr Gibrine Adam – President of Zenith University College and CEO of EPP Books Services – who has made significant contributions to the education sector through his educational establishments and philanthropic work. Awarding this prize each year will serve as an important inspiration for young African built environment academics.



9-11 AUGUST 2021

Labadi Beach Hotel  
Accra, Ghana and Online

**TIME**

08:45am to 16:00pm GMT/UTC

**Please note your local time zone  
may be different**



zoom

**Click on icon to attend online**

Meeting ID: 894 6050 4735

Passcode: 661844

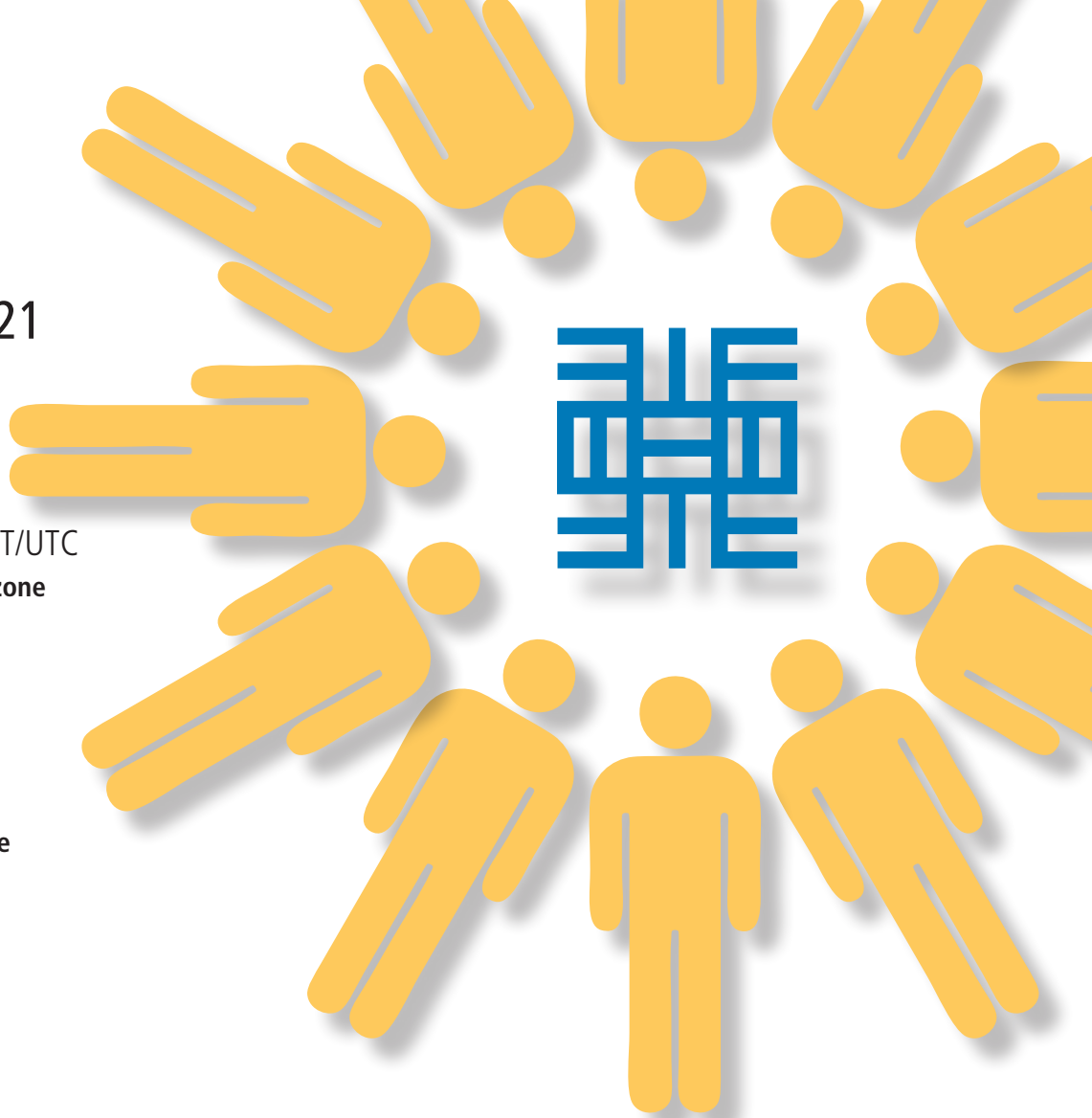

# PROGRAMME

**WEST AFRICA BUILT ENVIRONMENT RESEARCH CONFERENCE**

[WWW.WABERCONFERENCE.COM](http://WWW.WABERCONFERENCE.COM)

KNOWLEDGE, INTERACTION, PEOPLE & LEADERSHIP

## SPECIAL OPENING ADDRESS ON THE THEME OF ACADEMIC ASPIRATION AND EXCELLENCE

By **Professor Charles Egbu**, Vice Chancellor Leeds Trinity University, UK

Keynote presentations by experienced international academics



**Professor Charles Egbu**  
Vice Chancellor  
Leeds Trinity University, UK



**Professor Albert Chan**  
Department of Building  
and Real Estate  
Hong Kong Polytechnic University,  
Hong Kong



**Professor Taibat Lawanson**  
Department of Urban and  
Regional Planning  
University of Lagos, Nigeria



**Professor Asiah Abdul Rahim**  
Department of Architecture,  
International Islamic  
University Malaysia



**Professor George Ofori**  
Dean of School of the Built  
Environment and Architecture  
London South Bank University,  
UK



**Richard Lorch**  
Editor-in-chief  
of Buildings and Cities,  
former editor-in-chief of Building  
Research and Information





MONDAY 9th  
AUGUST 2021



# WABER 2021 CONFERENCE

<b>08:45-09:00</b>	<b>WELCOME REMARKS AND INTRODUCTION OF GUEST OF HONOUR BY PROFESSOR SAM LARYEA - CHAIRMAN OF WABER CONFERENCE</b>		
<b>09:00-10:00</b>	OPENING ADDRESS BY PROFESSOR CHARLES EGBU, VICE CHANCELLOR, LEEDS TRINITY UNIVERSITY, UK Theme: Academic aspiration and excellence		
<b>10:00-10:30</b>	<b>BREAK</b>		
<b>10:30-11:15</b>	KEYNOTE ADDRESS BY PROFESSOR ALBERT CHAN, HONG KONG POLYTECHNIC UNIVERSITY, HONG KONG Topic: Current trends and future directions of built environment research		
<b>11:15-11:30</b>	<b>BREAK</b>		
<b>11:30-12:40</b>	<b>PAPER PRESENTATIONS</b>		
	<b>PARALLEL SESSION 1</b>	<b>PARALLEL SESSION 2</b>	<b>PARALLEL SESSION 3</b>
<b>11:30-11:35</b>	Session Chair remarks Dr Humphrey Danso, AAMUSTED, Ghana	Session Chair remarks Prof Kulomri Adogbo, Ahmadu Bello University, Nigeria	Session Chair remarks Dr Cynthia Adeokun, O.N.A Architects London
<b>11:35-11:45</b>	Stress-coping strategies among construction personnel: an integrative review - Janet Mayowa Nwaogu and Albert P. C. Chan	Impact of risk factors on construction projects' quality in Nigeria - Ziyadul Hassan Ishaq, Mu'awiya Abubakar, Shehu Muhammad, Yarima Sallau Lawal and Ibrahim Isah	Automated recognition of construction workers' physical fatigue based on foot plantar patterns captured from a wearable insole pressure system - Maxwell Fordjour Antwi-Afari, Heng Li, David John Webb, Shahnawaz Anwer, JoonOh Seo, Kenneth Sungho Park and Alex Torku
<b>11:45-11:55</b>	The relationship between self-efficacy beliefs and career choices of undergraduate built environment students - Mariam Akinlolu and Theo C. Haupt	Awareness and perceptions of construction professionals on environmental risks in construction project delivery in Lagos and Ondo States, Nigeria - Deborah Abosede Ogungbemi and Ayokunle Olubunmi Olanipekun	Socio-psychological motivational needs of unskilled women working in Nigeria's construction industry - Seun Micheal Oloruntoba and Ayokunle Olubunmi Olanipekun
<b>11:55-12:05</b>	<b>Q&amp;A</b>		
<b>12:05-12:15</b>	Factors affecting the delivery of building construction projects funded by district assemblies common fund (dafc): the case of selected regions in Ghana - Aborah-Osei Castro and Humphrey Danso	Review of risk management studies: towards a frame of reference for large projects - Rilwan Shuaib Abdulrahman, Ahmed Doko Ibrahim, Baba Adama Kolo and Hassan Adaviriku Ahmadu	Covid-19 pandemic and co-working environment: analysis of shared office space in Federal Capital Territory (FCT), Abuja, Nigeria - Tosin B. Fateye, Abiodun K. Sodiya, Victoria O. Odunfa, Ayodele A. Ibuoye and Adewale R. Adedokun
<b>12:15-12:25</b>	Assessment of residents' perception of infrastructure delivery in Nigeria: the tale of Osogbo - Olatunji Solomon Ayodeji and Olowoporoku Oluwaseun Ayodele	Urban morphology and crime patterns in urban areas: a review of the literature - Idris Isah Iliyasu, Aldrin Abdullah and Massoomeh Hedayati Marzbali	The potential role of green infrastructure on mental health and well-being: the covid-19 pandemic experience - Adedotun Ayodele Dipeolu and Akintunde Olaniyi Onamade
<b>12:25-12:35</b>	<b>Q&amp;A</b>		
<b>12:35-12:40</b>	Session Chair remarks Dr Humphrey Danso, AAMUSTED, Ghana	Session Chair remarks Prof Kulomri Adogbo, Ahmadu Bello University, Nigeria	Session Chair remarks Dr Cynthia Adeokun, O.N.A Architects London
<b>12:40-13:30</b>	<b>BREAK</b>		



**Click on icon to attend online**

Meeting ID: 894 6050 4735

Passcode: 661844

# WABER 2021 CONFERENCE



MONDAY 9th  
AUGUST 2021



13:30-14:40 PAPER PRESENTATIONS			
	PARALLEL SESSION 1	PARALLEL SESSION 2	PARALLEL SESSION 3
13:30-13:35	Session Chair remarks Dr Humphrey Danso, AAMUSTED, Ghana	Session Chair remarks Prof Kulomri Adogbo, Amadu Bello University, Nigeria	Session Chair remarks Dr Cynthia Adekun, O.N.A Architects London
13:35-13:45	Assessing the causes of material wastage as it affects various building materials on Nigerian construction sites - A. A. Salihu, S. Gambo, M. M. Sa'ad, F. M. Oyeleke and J. Usman	Performance-based EPC contracting: a preliminary study of the challenges of engineering procurement and construction projects in Nigeria Aluko-Olokun Bukola Adenike, Baba Adama Kolo, Mustapha Abdulrazaq and Peter C. Gangas	BIM utilization in facilities management practice: a status study in South Africa - Faith Dowelani and Aghaegbuna O. U. Ozumba
13:45-13:55	Determination of factors that influence labour output on construction sites in Ghana - Joseph Henry Acquah, Humphrey Danso and Emmanuel Bamfo-Agyei	Enablers of mutual satisfaction in transnational public infrastructure development: the case of Sino- Ghana - Bridget Tawiah Badu Eshun, Albert P.C. Chan and Frank D.K. Fugar	The benefits of building information modeling in architectural education in Nigeria - Elimisiemon Monday Chris, Poopola J. O. and Salisu A. S.
13:55-14:05 Q&A			
14:05-14:15	Examination of energy consumption reduction measures for residential buildings in tropical climate (A Case Study of Birnin Kebbi, Nigeria) - Nkeleme Emmanuel Ifeanyichukwu, Sani Abdulrahman Tolani, Winston Shakantu and Mbamali Ikemefuna	Towards a research agenda for smart contract adoption in less technologically enabled construction environments: a systematic literature review - Ekweani Chioma Precious, Kolo Baba Adama, Adogbo Kulomri Jaule and Mohammed Abdullahi	BIM education ontology: towards a research agenda for non-industrialized economies - Abdulazeez Abdulmumin, B. A. Kolo, Y. G. Musa-Haddary and P. G. Chindo
14:15-14:25	An investigation into the use of building information modelling and its impact on construction performance within Ghanaian construction industry - Frederick Kwasi Wirekoh and Humphrey Danso	Key factors for electronic procurement systems in the promotion of sustainable procurement in construction projects - Sitsofe Kwame Yevu, Ann Tit Wan Yu, Amos Darko and Mershack Opoku Tetteh	Advancements in computer-aided design and the challenges for architectural education in Nigeria – feedback from the students' industrial work experience scheme - Sunday A. Bobadoye, Dorcas A. Ayeni, Saidat D. Olanrewaju and Ajenifujah-Aminat O. Ajenifujah-Abubakar
14:25-14:35 Q&A			
14:35-14:40	Session Chair remarks Dr Humphrey Danso, AAMUSTED, Ghana	Session Chair remarks Prof Kulomri Adogbo, Amadu Bello University, Nigeria	Session Chair remarks Dr Cynthia Adekun, O.N.A Architects London
14:40-15:00 BREAK			
15:00-15:45	KEYNOTE ADDRESS BY PROFESSOR GEORGE OFORI, LONDON SOUTH BANK UNIVERSITY, UK Topic: Construction in developing countries: need for new concepts and theorising of contextual specificities to the global corpus of knowledge		
15:45-16:00 WRAP UP AND CLOSE - SAM LARYEA, WITS UNIVERSITY, SOUTH AFRICA			



Click on icon to attend online

Meeting ID: 894 6050 4735

Passcode: 661844



TUESDAY 10th  
AUGUST 2021



# WABER 2021 CONFERENCE

<b>08:45-09:00</b>	<b>CHECK-IN AND OVERVIEW OF WHAT WE WILL COVER FOR THE DAY</b> <b>EMMANUEL ESSAH, UNIVERSITY OF READING, UK</b>		
<b>09:00-10:00</b>	SESSION FOR DOCTORAL STUDENTS AND SUPERVISORS - BY PROFESSOR ALBERT CHAN AND PROFESSOR GEORGE OFORI Topic: Experiential tips for doing and supervising doctoral research successfully		
<b>10:00-10:15</b>	<b>BREAK</b>		
<b>10:15-11:15</b>	EDITOR'S FORUM PRESENTATION BY RICHARD LORCH (EDITOR-IN-CHIEF OF BUILDINGS AND CITIES and FORMER EDITOR-IN-CHIEF OF BUILDING RESEARCH AND INFORMATION) FOLLOWED BY 15 MINS Q&A Topic: Elements of a good research article and what the editors and reviewers of top journals look for in modern scientific research articles		
<b>11:15-11:30</b>	<b>BREAK</b>		
<b>11:30-12:40</b>	<b>PAPER PRESENTATIONS</b>		
	<b>PARALLEL SESSION 1</b>	<b>PARALLEL SESSION 2</b>	<b>PARALLEL SESSION 3</b>
<b>11:30-11:35</b>	Session Chair remarks Dr Haruna Moda, Manchester Metropolitan University, UK	Session Chair remarks Prof Kola Akinsomi, Wits University, South Africa	Session Chair remarks Dr Amina Batagarawa, Baze University, Nigeria
<b>11:35-11:45</b>	Application of Information and Communication Technology on the implementation of health and safety measures by construction firms in Abuja, Nigeria - Abdullateef Adewale Shittu, Anita Dzikwi Adamu, Abel John Tsado, Lois Adedamola Arowolo and Shakirat Remilekun Abdulazez	Challenges to sustainable affordable housing using frugal innovation David Mbabel Dok-Yen, Duah Daniel Yaw Addai and Michael Nii Addy	Analytical nexus of urban liveability, liveable communities and place-making in African cities - Samuel Medayese, Hangwelani Magidimisha-Chipungu, Ayobami Popoola and Lovemore Chipungu
<b>11:45-11:55</b>	Assessment of the challenges and solutions to implementation of safety measures by small and medium sized construction firms in Abuja, Nigeria - Jibril Adamu Muhammad, Abdullateef Adewale Shittu, Yakubu Danasabe Mohammed, John Ebhohimen Idiake and Zannah Alhaji Ali	Development of social housing agenda to solve housing deficit in sub-Sahara Africa: a case for Ogun State, Nigeria - Babatunde Adekoyejo Jolaoso and Olusegun Olaopin Olanrele	Users' assessment of the relationship between housing quality and the conditions of residential outdoor spaces in Ilesa, Nigeria - Yussuf Shakirat Oladayo, Jiboye Adesoji David, Agbabiaka Hafeez Idowu, Adeyemi Toyin Ebenezer and Oke Oluyemi Ebenezer
<b>11:55-12:05</b>	<b>Q&amp;A</b>		
<b>12:05-12:15</b>	An Investigation into the safety performance of public buildings in relation to compliance of fire safety regulations: a case study of Ashanti and Greater Accra Regions of Ghana - Samuel Asumadu Roberts and Humphrey Danso	Housing affordability in Osogbo Osun State Nigeria - Akinremi Adenike R., Adedayo Adeyanju G., Saheed Jelili, Yussuf Shakirat O. and Ojo Omotayo 'Mubo	Awareness and acceptance of smart security system among occupants of selected public buildings in central business district (FCT-Abuja) Nigeria - Fatima Baba Ciroma, Musa Lawal Sagada and Joy Joshua Maina
<b>12:15-12:25</b>	Evaluation of health and safety compliance of construction projects in south east Nigeria - Chidinma Amarachukwu Emma-Ochu, Kevin C. Okolie and Ikem Mbamali	Factors influencing perceived value of residential properties in Free State Province, South Africa - Kahilu Kaji-mo-Shakantu, Barend Groenewald and Timothy O. Ayodele	Awareness of green infrastructure and its socio-demographic predictors among residents of Lagos metropolis, Nigeria - Adedotun Ayodele Dipeolu, Eziyi Offia Ibem, Joseph Akinlabi Fadamiro, Gabriel Fadairo, Joseph Adeniran Adedeji and Akintunde Olaniyi Onamade
<b>12:25-12:35</b>	<b>Q&amp;A</b>		
<b>12:35-12:40</b>	Session Chair remarks Dr Haruna Moda, Manchester Metropolitan University, UK	Session Chair remarks Prof Kola Akinsomi, Wits University, South Africa	Session Chair remarks Dr Amina Batagarawa, Baze University, Nigeria
<b>12:40-13:30</b>	<b>BREAK</b>		

# WABER 2021 CONFERENCE



TUESDAY 10th  
AUGUST 2021



13:30-14:40 PAPER PRESENTATIONS			
	PARALLEL SESSION 1	PARALLEL SESSION 2	PARALLEL SESSION 3
13:30-13:35	Session Chair remarks Dr Samuel Moveh, Universiti Teknologi Malaysia, Malaysia	Session Chair remarks Prof Kola Akinsomi, Wits University, South Africa	Session Chair remarks Dr Yakubu Aminu Dodo, Istanbul Gelisim University, Turkey
13:35-13:45	A study on interpersonal skills of Nigerian built environment professionals for the successful delivery of mass housing programmes - Mansir Dodo, Muhammad M. Gambo, Kabir Bala and Badamasi Abdulmalik	Micro-climatic benefits of Green infrastructure (trees) in a Housing Estate in Abuja, Nigeria - Tobi Eniolu Morakinyo, Olumuyiwa Bayode Adegun, Morisade O Adegbe and Olawale Oreoluwa Olusoga	Spatial accessibility to urban infrastructure services among hotels in the small city of Wa, Ghana Elvis Attakora-Amaniampong, Appau Williams Miller and Emmanuel K. Derbile
13:45-13:55	Adoption of technology in human resource management - a new normal - Kuforiji, A. Aramide	Investigating the effect of covid-19 driven inflation on commercial property hedging capacity in Lagos, Nigeria - Muktar Babatunde Wahab, Wasiu Ayobami Durosinmi, Matthew Mamman, Yetunde Christianah Charles- Afolabi and Dodo Usman Zakari	Modeling of future land use/land cover change dynamics in Lagos, Nigeria using cellular automata and Markov chain (Ca-Markov) - Auwalu Faisal Koko, Wu Yue, Muhammed Bello and Ghali Abdullahi Abubakar
13:55-14:05 Q&A			
14:05-14:15	Assessing the level of awareness on the concept of Design for Safety (Dfs) amongst design professionals in the construction industry in Nigeria - Mu'awiya Abubakar, Bello Mahmud Zailani and Abdulgafar Adamu	Students' perceptions about training on property valuation techniques in selected tertiary institutions in Nigeria - Augustina Chiwuzie, Daniel Ibrahim Dabara, Edith Mbagwu Prince, Sayo Tolani Olawuyi and Sayo Tolani Olawuyi	Assessment of factors responsible for outsourcing of facilities management services in public hospitals within Kaduna metropolis - Aliyu Suleiman Shika, Mohammed Mustapha Saad and Abdullahi Getso Ibrahim
14:15-14:25	An exploration of spatial layout and communication patterns in tertiary hospital design: an innovative approach to sustainable hospital design - Ejeh David Ekoja, Sagada Musa Lawal, Oluigbo Stephen Nwabunwanne, Maina Joy Joshua and Sufiyan Mu'awiyah Babale	Predictors of academic attainment in a Nigerian polytechnic: perceptions of estate management students - Augustina Chiwuzie	An innovative approach for the evalua- tion of expansion option in buildings - Yarima Sallau Lawal, Aliyu Makarfi Ibra- him, Mu'awiya Abubakar and Ziyadul Hassan Ishaq
14:25-14:35 Q&A			
14:35-14:40	Session Chair remarks Dr Samuel Moveh, Universiti Teknologi Malaysia, Malaysia	Session Chair remarks Prof Kola Akinsomi, Wits University, South Africa	Session Chair remarks Dr Yakubu Aminu Dodo, Istanbul Gelisim University, Turkey
14:40-15:00 BREAK			
15:00-15:45	KEYNOTE ADDRESS BY PROFESSOR TAIBAT LAWANSON, UNIVERSITY OF LAGOS, NIGERIA Topic: Rethinking current approaches to urban development in Africa		
15:45-16:00 WRAP UP AND CLOSE - EMMANUEL ESSAH, UNIVERSITY OF READING, UK			



Click on icon to attend online

Meeting ID: 894 6050 4735

Passcode: 661844





WEDNESDAY  
11th AUGUST  
2021



# WABER 2021 CONFERENCE

<b>08:45-09:00</b>	<b>CHECK-IN AND OVERVIEW OF WHAT WE WILL COVER FOR THE DAY</b> <b>PROFESSOR SAM LARYEA, WITS UNIVERSITY, SOUTH AFRICA</b>		
<b>09:00-10:00</b>	KEYNOTE ADDRESS BY PROF ASIAH ABDUL RAHIM, INTERNATIONAL ISLAMIC UNIVERSITY, MALAYSIA Topic: Current trends and future directions in the inclusive, sustainable and tropical design of built facilities		
<b>10:00-10:30</b>	<b>BREAK</b>		
<b>10:30-11:15</b>	KEYNOTE ADDRESS BY PROF ALBERT CHAN, HONG KONG POLYTECHNIC UNIVERSITY, HONG KONG Topic: Insights for developing individual and institutional research areas and strategies in construction and real estate		
<b>11:15-11:30</b>	<b>BREAK</b>		
<b>11:30-12:40</b>	<b>PAPER PRESENTATIONS</b>		
	<b>PARALLEL SESSION 1</b>	<b>PARALLEL SESSION 2</b>	<b>PARALLEL SESSION 3</b>
<b>11:30-11:35</b>	Session Chair remarks Dr Maxwell Fordjour Antwi-Afari, Aston University, UK	Session Chair remarks Dr Humphrey Danso, AAMUSTED, Ghana	Session Chair remarks Dr Sarfo Mensah, Kumasi Technical University, Ghana
<b>11:35-11:45</b>	Conceptual framework for whole-life cost data transformation and model selection - Ibrahim, A., M. , Bala, K. , Ibrahim, A. D. , Zubairu, I. K.	Water absorption quality of clay bricks made by emerging manufacturers in SouthAfrica Bonga PraiseGod Khuzwayo	Comparative analysis of soundness and setting time of Portland cement of three companies in Nigeria - Angulu Haruna, Abba Musa, Samaila Hamza, Galadima Muhammad and Odesanmi, Atinuke
<b>11:45-11:55</b>	The impact of project contributory factors on the cost performance of building projects - V. H. Jiya, A. D. Ibrahim, D. Kado and K. Bala	Effects of sand on the properties of cement-laterite interlocking blocks - Sampson Assiamah and Humphrey Danso	Effect of cereal flours on the properties of concrete - Alfa Nasirudeen Musa and Adeleke Babatunde Kazeem
<b>11:55-12:05</b>	<b>Q&amp;A</b>		
<b>12:05-12:15</b>	Developing a framework for public private partnership project governance in Nigeria - Atoyebi Kayode Emmanuel and Ojo Stephen Okunlola	Effect of petroleum contamination on some selected properties of compressed stabilized earth brick (CSEB) K. A. N. Sackey, M. M. Garba, O. G. Okoli and D. D. Dahiru	Effect of palm kernel shell as coarse aggregate on the properties of concrete A.G. Ibrahim, A. Yahya, M.M. Gambo, S. Gambo and J. Usman
<b>12:15-12:25</b>	Contractors' selection and its effects on water infrastructure delivery Mkasi P., Ogbeifun E. and Pretorius J. H. C.	Suction of clayey soil treated with quarry dust base geopolymer cement for sustainable pavement subgrade construction - Ezenwa Chinenye Amanamba and Kennedy Chibuzor Onyelowe	Effects of maximum aggregate sizes on flexural strength of recycle iron and steel slag (RIIS) concrete - Oluwaleke Adekunle Olowu, Akeem Ayinde Raheem, Abiodun Yesiru Akinsanya and Victor Ikechukwu Opara
<b>12:25-12:35</b>	<b>Q&amp;A</b>		
<b>12:35-12:40</b>	Session Chair remarks Dr Maxwell Fordjour Antwi-Afari, Aston University, UK	Session Chair remarks Dr Humphrey Danso, AAMUSTED, Ghana	Session Chair remarks Dr Sarfo Mensah, Kumasi Technical University, Ghana
<b>12:40-13:30</b>	<b>BREAK</b>		



**Click on icon to attend online**

Meeting ID: 894 6050 4735

Passcode: 661844

# WABER 2021 CONFERENCE



WEDNESDAY  
11th AUGUST  
2021



13:30-14:40 PAPER PRESENTATIONS			
	PARALLEL SESSION 1	PARALLEL SESSION 2	PARALLEL SESSION 3
13:30-13:35	Dr Afolabi Dania, University of Westminster, UK	A/Prof Emmanuel Essah, University of Reading, UK	Session Chair remarks Dr Sarfo Mensah, Kumasi Technical University, Ghana
13:35-13:45	Responsible material sourcing: Assessment of factors influencing construction material sustainability - Nana Benyi Ansah , Emmanuel Adinyira , Kofi Agyekum and Isaac Aidoo	Modelling optimal unconfined compressive strength of geotextile reinforced soil for flexible foundation construction - Daniel E. Aju and Kennedy C. Onyelowe	Investigating the effect of curing methods on the strength properties of concrete - Francis Kwesi Nsakwa Gabriel-Wetty and Humphrey Danso
13:45-13:55	Social procurement and sustainability in the Nigerian construction industry - Francis O. Okeke and Rosemary C. Nnaemeka-Okeke	ANFIS model of the UCS of modified soil for construction purposes - Udeala, R. C., Onyelowe, K. C., Uranta, J. D. C., Keke, E. O. and Alaneme, G. U.	Assessment of seasonal flood impact and management strategies in Okitipupa, Ondo State, Nigeria - Olorunlana, Folasade Aderonke
13:55-14:05 Q&A			
14:05-14:15	The relationship of attitude and perceived behavioral control on behavioral intention to practice surveying - Ayodele Oduwole	Households' exposure to indoor air pol- lution from fossil fuel electric generator use in Minna Nigeria - C. B. Ohadugha, Y. A. Sanusi, A. O. Sulyman, B. N. Santali, M. Mohammed and S. O. Medayese	Session Chair remarks Dr Sarfo Mensah, Kumasi Technical University, Ghana
14:15-14:25	The role of safety attitude in changing safety behaviour and hazard recognition capability of construction workers - Bello Mahmud Zailani, Mu'awiya Abubakar and, Yahaya Makarfi Ibrahim	Diurnal temperature changes and physiological experience: case study analysis of indoor condition in a school environment in Nigeria - Eludoyin Oyenike Mary	Join Session 1 or Sesion 2
14:25-14:35 Q&A			
14:35-14:40	Dr Afolabi Dania, University of Westminster, UK	A/Prof Emmanuel Essah, University of Reading, UK	
14:40-15:00 BREAK			
15:00-15:45	KEYNOTE ADDRESS BY PROFESSOR GEORGE OFORI, LONDON SOUTH BANK UNIVERSITY, UK Topic: What African built environment academics and departments need to know and strategise in the march forward into the future		
15:45-16:00 CONFERENCE SUMMARY, PRESENTATION OF CERTIFICATES/PRIZES, VOTE OF THANKS PROFESSOR SAM LARYEA, CHAIRMAN OF WABER CONFERENCE			

## PRIZES TO BE AWARDED AT THE WABER 2021 CONFERENCE

### BEST RESEARCH PAPER AWARD

This prize is awarded to recognize the author(s) of an original piece of research which contributes a better understanding of the research question/problem investigated and demonstrates a high degree of scientific quality and innovative thought.

This prize was created to acknowledge the continuing importance of high quality research to academic institutions, a researcher's reputation and the development of the built environment field.

### BEST PRESENTATION AWARD

This prize is awarded to recognise the presentation which is the most coherent, clearly enunciated, well-paced, easy to understand, and effective. The award is given on the basis of quality of the presentation and not the written paper. It recognizes the best presentation based on communication of the content of a paper and the ability of the speaker to deliver an impactful, authoritative and engaging presentation.

### GIBRINE ADAM PROMISING YOUNG SCHOLAR AWARD

This prize is awarded to recognize and encourage exceptional young researchers.

The recipient should be a young academic who demonstrates promise, such that he/she is likely to become established as a research leader.



**Professor Charles Egbu**  
Vice Chancellor  
Leeds Trinity University, UK

## WABER **2021** CONFERENCE SPECIAL OPENING ADDRESS

**Professor Charles Egbu** joined Leeds Trinity University as Vice-Chancellor on 1 November 2020. He leads the University on all strategic matters; ensuring financial sustainability to allow the delivery of the University's Strategic Plan, including the overall vision and values of the University. He represents the University externally at various groups including Universities UK (UUK), Million Plus and the Cathedral's Group. He works closely with industry and professional bodies, especially in the Built Environment sector, and with local communities.

Professor Egbu's research interests focus on project management, construction management and sustainable development; subjects about which he has written 12 books and contributed to more than 350 publications in various international journals and conferences. He has supervised over 25 PhD students and examined over 100 PhD candidates world-wide. In addition, he has acted as an external examiner to many undergraduate and postgraduate programmes in universities all over the world



**Richard Lorch**  
Editor-in-chief  
of Buildings and Cities,  
former editor-in-chief of Building  
Research and Information  
and executive editor  
of Climate Policy

## WABER **2021** CONFERENCE INVITED SPEAKER FOR THE EDITOR'S FORUM ON TUESDAY 10TH AUGUST

**Richard Lorch** is an architect, researcher, writer and editor-in-chief of Buildings & Cities. He was the former editor-in-chief of Building Research and Information and executive editor of Climate Policy.

He is a visiting professor at University College London and Politecnico di Milano and on the advisory board of the Dresden Leibniz Graduate School. He works on organisational / policy responses to climate change - mitigation and adaptation paths - and the environmental impacts of the built environment and building performance at different scales from the individual building to neighbourhood to city.

As editor, his key concerns are fair, robust peer review assessment and feedback processes, author support and the diffusion and take-up of research and new knowledge by 'end users' - promoting two-way dialogue and co-production between stakeholders, practitioners, policy makers and the academic community.

# WABER 2021 CONFERENCE

## KEYNOTE SPEAKER



**Professor Albert Chan**  
Department of Building  
and Real Estate  
Hong Kong Polytechnic University,  
Hong Kong

**Professor Albert Chan** is Associate Director of RISUD and Able Professor in Construction Health and Safety and Chair Professor of Construction Engineering and Management, Hong Kong Polytechnic University, Hong Kong.

A Chartered Construction Manager, Engineer, Project Manager, and Surveyor by profession, Prof. Chan has worked in a number of tertiary institutions both in Hong Kong and overseas. He was a Senior Lecturer and Deputy Head of the School of Building and Planning at the University of South Australia.

Professor Chan joined the Department of Building and Real Estate of the Hong Kong Polytechnic University in 1996 and was Associate Head (Teaching) from 2005 to 2011; Associate Dean and Interim Dean of the Faculty of Construction and Environment from 2011 to 2013, and from 2013 to 2014 respectively.

His outstanding research performance has resulted in the appointment of Able Professor in Construction Health and Safety in August 2019. He has produced over 1,000 research outputs in refereed journal papers, international refereed conference papers, consultancy reports, and other articles. He has won numerous prestigious research paper and innovation awards since 1995. Professor Chan served as an expert member in the Built Environment Panel of FORMAS, Swedish Research Grants Council. He was also an expert member to assess the research performance of the Faculty of Architectural and the Built Environment, TU Delft, the Netherlands. Professor Chan is currently an expert member of the Engineering Panel of the Research Grants Council, HKSAR.

Professor Chan holds an MSc in Construction Management and Economics from the University of Aston in Birmingham, and a PhD in Project Management from the University of South Australia. He has been an Adjunct Professor in a number of universities. Professor Chan was also a Founding Director of Construction Industry Institute, Hong Kong, which was a joint research institution developed by industry and the academia.





**Professor Taibat Lawanson**  
Department of Urban and  
Regional Planning  
University of Lagos, Nigeria

## WABER **2021** CONFERENCE KEYNOTE SPEAKER

**Professor Taibat Lawanson** is a Professor in the Department of Urban and Regional Planning at the University of Lagos, Nigeria, where she leads the Pro-poor Development and Urban Management Research Cluster. She is also co-director at the University of Lagos Centre for Housing and Sustainable Development. She holds a PhD in Urban and Regional Planning from the Federal University of Technology, Akure, Nigeria.

She has conducted extensive research on issues relating to urban informality, livability, environmental justice and pro-poor development. She is interested in how formal and informal systems can synthesize in the emerging African city, and written or co-authored over 60 articles in peer-reviewed journals, books and conference proceedings and enjoyed funding support for her work from UKAid, USAID, Cambridge Alborada Research Fund, GCRF, British Academy and University of Beyreuth 'Africa Multiple' among others. She is a member of the editorial advisory board of Area Development and Policy Journal of the Regional Studies Association and International Corresponding Editor at Urban Studies Journal.

She is also a member of the advisory committee of UNHABITAT flagship 'State of the World's Cities Report'. She is a registered town planner and a member of the Human Capacity Development Association, Urban Affairs Association and International Society of City and Regional Planners among others. Taibat is a proud alumnus of the prestigious Rockefeller Foundation Bellagio Academic Residency and is a 2013 World Social Science Fellow of the International Social Science Council.



**Professor Asiah Abdul Rahim**  
Department of Architecture,  
International Islamic  
University Malaysia

## WABER **2021** CONFERENCE KEYNOTE SPEAKER

**Professor Dato' Sri Ar Dr Asiah Abdul Rahim**, is a Professor at the Department of Architecture in Kulliyah of Architecture and Environmental Design (KAED), International Islamic University Malaysia (IIUM), apart from being a Professional Architect, she used to managed her own Architectural Firm, DASAR Architect, she is also a renowned architect in Designing and managing construction for various building typologies. She is also Universal Design Expert and an Access Audit Consultant.

She obtained her PhD from Oxford Brookes University in Oxford, United Kingdom with her previous degree of B. Arch from Deakin University in Australia and a Diploma in Architecture from our local University of Technology Malaysia (UTM). She was among the pioneer lecturers in establishing Kulliyah of Architecture & Environmental Design (KAED) of International Islamic University Malaysia (IIUM) about 22 years ago.

# WABER 2021 CONFERENCE KEYNOTE SPEAKER



**Professor George Ofori**  
Dean of School of the Built  
Environment and Architecture  
London South Bank University,  
UK

**Professor George Ofori** specialises in Construction Management and Economics, at the project, company and industry levels. His main subject of research is the improvement of the capacity and capability of the construction industry, especially in developing countries. Professor Ofori was educated at the University of Science and Technology in Kumasi, Ghana where he obtained a BSc (Building Technology in Quantity Surveying) (First Class Honours). He worked briefly in that university as a Teaching Assistant before proceeding to the UK to study for an MSc (Building Economics and Management) (Distinction) degree at University College London, from where he also obtained a Ph.D. degree in 1981.

He was subsequently awarded a DSc degree by the University of London in 1998. Professor Ofori is a Fellow of the Ghana Academy of Arts and Sciences. Professor Ofori worked with G.A. Takyi and Partners in Accra, Ghana, as a Senior Quantity Surveyor for two years.

From 1983 to 2017, he was employed by the National University of Singapore, where he was promoted to Full Professor in 1999, and was the Head of the Department of Building for five years. He has been a consultant to many governments and international agencies on construction industry development.



*We would like to sincerely thank  
all our distinguished speakers  
for accepting to be part of this year's*

**WABER 2021 CONFERENCE**

**CONFERENCE PAPERS**

## CONFERENCE PAPERS

A study on interpersonal skills of Nigerian built environment professionals for the successful delivery of mass housing programmes – Dodo, M., Gambo, M. M., Bala K., and Abdulmalik, B.	21
Adoption of technology in human resource management - a new normal – Kuforiji, A. A., Eze, B. D. and Fajana, S.	33
Advancements in computer-aided design and the challenges for architectural education in Nigeria – feedback from the students' industrial work experience scheme - Bobadoye, S. A., Ayeñi, D. A., Olanrewaju S. D. and Ajenifujah-Abubakar, A. O.	43
An exploration of spatial layout and communication patterns in tertiary hospital design: an innovative approach to sustainable hospital design - Ejeh, D. E., Sagada, M. L., Oluigbo, S. N., Maina, J. J. and Sufiyan, M. B.	59
An innovative approach for the evaluation of expansion option in buildings - Lawal, Y. S., Ibrahim, A. M., Abubakar, M. and Ishaq, Z. H.	81
An investigation into the safety performance of public buildings in relation to compliance of fire safety regulations: a case study of Ashanti and Greater Accra regions of Ghana - Asumadu, R. S. and Danso, H.	99
An investigation into the use of building information modelling and its impact on construction performance within Ghanaian construction industry - Wirekoh, F. K. and Danso, H.	115
Analytical nexus of urban liveability, liveable communities and place-making in African cities - Medayese, S., Magidimisha-Chipungu, H., Popoola, A. and Chipungu, L.	137
ANFIS model of the UCS of modified soil for construction purposes - Udeala, R. C., Onyelowe, K. C., Uranta, J. D. C., Keke, E. O. and Alaneme, G. U.	163
Application of information and communication technology for the implementation of health and safety measures by construction firms in Abuja, Nigeria - Shittu, A. A., Adamu, A. D., Tsado, A. J., Arowolo, L. A. and Abdulazeez, S. R.	177
Assessing the causes of material wastage as it affects various building materials on Nigerian construction sites - Salihu, A. A., Gambo, S., Sa'ad, M. M., Oyeleke, F. M. and Usman, J.	195
Assessing the level of awareness on the concept of Design for Safety (DfS) amongst design professionals in the construction industry in Nigeria - Abubakar, M., Zailani, B. M. and Adamu, A.	207
Assessment of factors responsible for outsourcing of facilities management services in the public hospitals within Kaduna metropolis - Shika, A. S., Saad, M. M. and Ibrahim, A. G.	219
Assessment of residents' perception of infrastructure delivery in Nigeria: the tale of Osogbo - Olatunji, S. A. and Olowoporoku, O. A.	235
Assessment of seasonal flood impact and management strategies in Okitipupa, Ondo State, Nigeria - Olorunlana, F. A.	249
Assessment of the challenges and solutions to implementation of safety measures by small and medium sized construction firms in Abuja, Nigeria - Muhammad, J. A., Shittu, A. A., Mohammed, Y. D., Idiako J. E. and Ali, Z. A.	259
Automated recognition of construction workers' physical fatigue based on foot plantar patterns captured from a wearable insole pressure system - Antwi-Afari, M. F., Li, H., Webb, D. J., Anwer, S., Seo, J., Park, K. S. and Torku, A.	277
Awareness and acceptance of smart security system among occupants of selected public buildings in central business district (FCT-Abuja) Nigeria - Ciroma, F. B., Sagada, M. L. and Maina, J. J.	287
Awareness and perceptions of construction professionals on environmental risks in construction project delivery in Lagos and Ondo States, Nigeria - Ogungbemi, D. A. and Olanipekun, A. O.	299

Awareness of green infrastructure and its socio-demographic predictors among residents of Lagos Metropolis, Nigeria - Dipeolu, A. A., Ibem, E. O., Fadamiro, J. A., Fadairo, G., Adedeji, J. A. and Onamade, A. O.	311
BIM education ontology: towards a research agenda for non-industrialised economies – Abdulmumin, A., Kolo, B. A., Musa-Haddary, Y. G. and Chindo, P. G.	333
BIM utilization in facilities management practice: a status study in South Africa – Dowelani, F. and Ozumba, A. O. U.	351
Challenges to sustainable affordable housing using frugal innovation - Dok-Yen, D. M., Duah, D. Y. A and Addy, M. N.	363
Comparative analysis of soundness and setting time of portland cement of three companies in Nigeria - Angulu, H., Abba, M., Samaila, H., Galadima, M. and Odesanmi, A.	379
Conceptual framework for whole-life cost data transformation and model selection in the building sector - Ibrahim, A. M., Bala, K., Ibrahim, A. D. and Zubairu, I. K.	391
Construction in developing countries: need for new concepts and theorising of contextual specificities to the global corpus of knowledge – Ofori, G.	405
Contractors' selection and its effects on water infrastructure delivery – Mkasi, P., Ogbeifun, E. and Pretorius, J. H. C.	419
Covid-19 pandemic and co-working environment: analysis of shared office space in Federal Capital Territory (FCT), Abuja, Nigeria - Fateye, T. B., Sodiya, A. K., Odunfa, V. O., Ibuoye, A. A. and Adedokun A. R.	431
Design trends and future planning for inclusive development in tropical built environment - Rahim, A. A., Samad, N. A. A. and Seman, W. M. W.	449
Determination of factors that influence labour output on construction sites in Ghana - Acquah, J. H., Danso, H. and Bamfo-Agyei, E.	457
Developing a Framework for Public Private Partnership Project Governance in Nigeria - Atoyebi, A. K. and Ojo, S. O.	469
Development of social housing agenda to solve housing deficit in sub-Saharan Africa: a case for Ogun State, Nigeria - Jolaoso, B. A. and Olanrele, O. O.	483
Diurnal temperature changes and physiological experience: case study analysis of indoor condition in a school environment in Nigeria - Eludoyin, O. M.	501
Effect of cereal flours on the properties of concrete - Alfa, N. M. and Adeleke, B. K.	515
Effect of palm kernel shell as coarse aggregate on the properties of concrete - Ibrahim, A. G., Yahya, A., Gambo, M. M., Gambo, S. and Usman, J.	529
Effect of petroleum contamination on properties of Compressed Stabilized Earth Brick (CSEB) - Sackey, K. A. N., Garba, M. M., Okoli, O. G. and Dahiru, D. D.	543
Effects of maximum aggregate sizes on flexural strength of recycle iron and steel slag concrete - Olowu, O. A., Raheem, A. A., Akinsanya, A. Y. and Opara, V. I.	557
Effects of sand on the properties of cement-laterite interlocking blocks - Assiamah, S. and Danso, H.	569
Enablers of mutual satisfaction in transnational public infrastructure development: the case of Sino-Ghana - Eshun, B. T. B., Chan, A. P. C. and Fugar, F. D. K.	579
Evaluation of health and safety compliance of construction projects in South East Nigeria - Emma-Ochu, C. A., Okolie, K. C. and Mbamali, I.	597
Examination of energy consumption reduction measures for residential buildings in tropical climate: a Case Study of Birnin Kebbi, Nigeria - Ifeanyi-chukwu, N. E., Tolani, S. A., Shakantu, W. and Ikemefuna, M.	609
Factors affecting the delivery of building construction projects funded by District Assemblies Common Fund (DACF): the case of selected regions in Ghana - Aborah-Osei, C. and Danso, H.	629
Factors influencing perceived value of residential properties in Free State Province, South Africa - Kajimo-Shakantu, K., Groenewald, B. and Ayodele, T. O.	645

Households' exposure to indoor air pollution from fossil fuel electric generator use in Minna Nigeria - Ohadugha, C. B., K., Sanusi, Y. A., Sulyman, A. O., Santali, B. N., Mohammed, M. and Medayese, S. O.	661
Housing affordability in Osogbo Osun State Nigeria - Akinremi, A. R., K., Adedayo, A. G., Saheed, J., Yussuf, S. O., and Ojo, O. M.	671
Impact of risk factors on construction projects 'quality in Nigeria - Ishaq, Z. I., K., Abubakar, M., Muhammad, S., Lawal, Y. S. and Isah, I.	685
Investigating the effect of Covid-19 driven inflation on commercial property hedging capacity in Lagos, Nigeria - Wahab, M. B., Durosinmi, W. A., Mamman, M., Charles-Afolabi, Y. C. and Zakari, D. U.	701
Investigating the effect of curing methods on the strength properties of concrete - Gabriel-Wetley, F. K. N. and Danso, H.	715
Key factors for electronic procurement systems in the promotion of sustainable procurement in construction projects - Yevu, S. K., Yu, A. T. W., Darko, A. and Tetteh, M. O.	725
Micro-climatic benefits of Green infrastructure (trees) in a Housing Estate in Abuja, Nigeria - Morakinyo, T. E., Adegun, O. B., Adegbie, M. O. and Olusoga, O. O.	739
Modelling of future land use/land cover change dynamics in Lagos, Nigeria using Cellular Automata and Markov Chain (CA-MARKOV) Model - Auwalu, F. K., Wu, Y., Muhammed, B. and Ghali, A. A.	749
Modelling optimal unconfined compressive strength of geotextile reinforced soil for flexible foundation construction – Aju, D. E. and Onyelowe, K. C.	763
Performance-based EPC contracting: a preliminary study of the challenges of engineering procurement and construction projects in Nigeria - Aluko-Olokun B. A., Kolo, B. A., Abdulrazaq, M. and Gangas, P. C.	779
Predictors of academic attainment in a Nigerian polytechnic: perceptions of estate management students - Chiwuzie, A.	793
Responsible material sourcing: an assessment of factors influencing construction material sustainability – Ansah, N. B., Adinyira, E., Agyekum, K. and Aidoo, I.	805
Review of risk management studies: towards a frame of reference for large projects – Abdulrahman, R. S., Ibrahim, A. D., Kolo, B. A. and Ahmadu, H. A.	823
Social procurement and sustainability in the Nigerian construction industry – Okeke, F. O. and Nnaemeka-Okeke, R. C.	843
Socio-psychological motivational needs of unskilled women working in Nigeria's construction industry – Oloruntoba, S. M. and Olanipekun, A. O.	857
Spatial accessibility to urban infrastructure services among hotels in the small city of Wa, Ghana – Attakora-Amaniampong, E., Appau, W. M. and Derbile, E. K.	875
Stress-coping strategies among construction personnel: an integrative review – Nwaogu, J. M. and Chan, A. P. C.	895
Students' perceptions about training on property valuation techniques in selected tertiary institutions in Nigeria – Chiwuzie, Dabara, D. I., Prince, E. M., Aiyepada, E. G. and Olawuyi, S. T.	909
Suction of clayey soil treated with quarry dust base geopolymers for sustainable pavement subgrade construction - Amanamba, E. C. and Onyelowe, K. C.	925
The benefits of building information modeling in architectural education in Nigeria - Elimisiemon, Monday Chris, Poopola, J. O. and Salisu, A. S.	933
The impact of project contributory factors on the cost performance of building projects - Jiya, V. H., Ibrahim, A. D., Kado, D. and Bala, K.	945
The potential role of green infrastructure on mental health and well-being: the covid-19 pandemic experience - Dipeolu, A. A. and Onamade, A. O.	957
The relationship between self-efficacy beliefs and career choices of undergraduate built environment students - Akinlolu, M. and Haupt, T. C.	973
The relationship of attitude and perceived behavioral control on behavioral intention to practice surveying – Oduwole, A.	987

The role of safety attitude in changing safety behaviour and hazard recognition capability of construction workers - Zailani, B. M., Abubakar, M., and Ibrahim, Y. M.	1001
Towards a research agenda for smart contract adoption in less technologically enabled construction environments: a systematic literature review - Ekweani, C. P., Kolo, B. A., Adogbo, A. K. and Mohammed, A.	1013
Urban morphology and crime patterns in urban areas: a review of the literature - Iliyasu, I. I., Abdullah, A. and Marzballi, M. H.	1023
Users 'assessment of the relationship between housing quality and the conditions of residential outdoor spaces in Ilesa, Nigeria - Yussuf, S. O., Jiboye, A. D., Agbabiaka, H. I., Adeyemi, T. E. and Oke, O. E.	1045
Water absorption quality of clay bricks made by emerging manufacturers in South Africa - Khuzwayo, B. P.	1063
<b>INDEX OF AUTHORS</b>	<b>- 1077 -</b>
<b>INDEX OF KEYWORDS</b>	<b>- 1081 -</b>



# A STUDY ON INTERPERSONAL SKILLS OF NIGERIAN BUILT ENVIRONMENT PROFESSIONALS FOR THE SUCCESSFUL DELIVERY OF MASS HOUSING PROGRAMMES

Mansir Dodo<sup>1</sup>, Muhammad M. Gambo<sup>2</sup>, Kabir Bala<sup>3</sup> and Badamasi Abdulmalik<sup>4</sup>

<sup>1,3</sup>*Department of Building, Ahmadu Bello University Zaria, Nigeria.*

<sup>2</sup>*Shelter Afrique, Nairobi, Kenya*

<sup>4</sup>*School of Built Environment, University of Salford, Manchester, England*

The Nigerian Economic Sustainability Plan (NESP) 2021 is the most current national plan in Nigeria. It aims to alleviate the economic emergency caused by the COVID-19 pandemic, as well as bridge the housing deficit in the country. The Mass Housing Programme of the NESP is predicted to provide 300,000 houses in 12 months. Also, the project is expected to produce 1.8 million jobs and help Nigeria reach Goal 11 of the Sustainable Development Goals (SDG). However, the capacity of relevant built environment specialists has affected the successful delivery of previous mass housing programmes in Nigeria, which poses a possible hurdle to the successful delivery of the planned Mass Housing Programme in the NESP. This research aims to study the interpersonal skill of the built environment professionals towards successful delivery of mass housing projects. The data was acquired using an online survey with the aid of a structured questionnaire. A total of 137 professionals participated in the survey. Data were analyzed descriptively and inferentially. Study discovered that none of the factors studied is deemed to be of essential priority. Likewise, the following interpersonal skills are opined to be of higher priority: decision making; leadership; communication; team building; motivation; trust-building; influencing, and conflict management. However, more attention must be given to the interpersonal factors coaching, negotiation, and political and cultural awareness. The implication of this study may imply that, to successfully deliver mass housing projects like the Mass Housing Programme proposed in the NESP, academic institutions, construction firms, and professional bodies must invest more in education and training programs supporting and facilitating coaching, negotiation, and, most importantly, political and cultural awareness.

Keywords: built environment professionals, interpersonal skills, mass housing programme, Nigerian economic sustainability plan

## INTRODUCTION

Housing is essential for people worldwide. According to (Intel, 2020), housing has helped to revitalize a country or economy during the initial stages of global

---

<sup>1</sup> mdodo@abu.edu.ng

<sup>2</sup> mgambo@shelterafrique.org

<sup>3</sup> balakabir@abu.edu.ng

<sup>4</sup> a.a.badamasi@edu.salford.ac.uk



downturn. In both developed and developing countries, the housing sector is highly relevant. Historically, housing has been a dominant business cycle in the United States of America (USA), exceeding all other investments (Ahadzie, 2014). Also, there are claims that mainstream home building helped propel Japan's current economic success. Infact, during the 1970s and 1990s, macroeconomic stability of the housing sector in Japan significantly increased demand and kept jobs even during recessions (Ahadzie, 2014). During similar periods, other countries such as Thailand and Singapore equally employed housing investments as economic revitalisation methods. As such, housing in general, but especially mass housing serves both short-term and long-term goals of development plans of countries.

The Japanese government has taken concerted steps to enhance the nation's housing supply, with an average yearly commitment of 7% to 9% of GDP (Zairul, 2011). Another primary housing-policy objective is economic growth and investment, and savings. Similar policies exist in Singapore, Hong Kong, Taiwan, and South Korea (Noorzai, 2020). These governments do not only see housing as an economic base but consider housing projects as an assured way to grow the economy which is invariably a fiscal stabilization project (Zairul, 2011). As reported by Intel (2020), a new house provides 1.5 direct and eight secondary jobs in India. Similarly, there are 5.62% direct jobs created in South Africa and 2.5% indirect jobs anytime a new house is constructed. Hence, the construction of houses is a booster of socio-economic development.

The World Bank indicates that urban population in Nigeria increase at 4.23% annually and that urban population accounts for 50% of its total population (NBS, 2019). This rapid urbanization rate, primarily due to migration, has increased housing demand. Construction in Nigeria has a significant impact on the country's economic growth. The impact of housing on the overall economy is extensive. Nigeria's construction sector accounts for 4% of the country's GDP (NBS, 2019; Ajayi, 2020). The building industry creates numerous jobs for skilled, semi-skilled and unskilled workers every time a new construction job is initiated. According to Intel (2020), increased housing construction as a result of mass housing projects such as the Federal Mortgage Bank of Nigeria (FMBN) housing projects would help spur economic recovery and encourage economic inclusion by generating substantial number of jobs both in the formal and informal sector.

Nigeria has had several housing policies and programs. According to (Ikediashi et al., 2012), in the early 1980s, for example, the Shagari mass housing project was implemented across the country. Bilau et al., (2015) also reports on the mass housing programme initiated in Kogi State. Likewise, the Family Homes Fund (FHF) was established to support the developing of 2 million new homes and shelter 500,000 households by 2020 (Ajayi, 2020). Essentially, both federal and state governments have made massive housing initiatives in Nigeria. More recently, the FMBN Housing Stock Development Initiatives captured in the Nigerian Economic Sustainability Plan (NESP) is intended to have a nationwide impact especially due to the crippling effect of COVID-19 in the national economy (Ajayi, 2020). These efforts demonstrate Nigeria's desire for large-scale housing invariably affecting economic development.

The Mass Housing Programme in the NESP supposedly plans to deliver 300,000 housing units to all 774 local governments in 12 months. However, educational and training capability are required for successful delivery of such large-scale undertakings (Sunindijo & Zou, 2011) (Project Management Institute, 2013). In Nigeria, there exist researches on education and training specific to mass housing. For instance, the work of Suleman and Sagada (2012) covered mass housing specific to design considerations as well as use of materials in public housing schemes of Barnawa and Malali low-cost housing estates in Kaduna, Nigeria. Similarly, the research of (Bilau et al., 2015) focused on education and skill acquisition relative to reconstruction activities of mass housing affected by disasters. Although these researches somewhat covered technical skills, they both report that there is a deficit in capacity of the built environment professionals towards successfully delivering mass housing projects. Considering the scale of the proposed Mass Housing Programme in the NESP, this capacity deficit poses potential challenge to the successful delivery. As such, this research intends to initially review Mass Housing Programme in the NESP, and then ascertain the interpersonal skills of the built environment professionals towards successful delivery of the such initiatives. Interpersonal skills will be covered in this study based on how essential such skills are in successful delivery of large-scale construction projects. The findings from this study will have implications for improved implementation of large-scale construction projects in Nigeria.

## **MASS HOUSING IN NIGERIA**

Mass housing means houses produced in large numbers on a wide scale for public purchase, either as the owner-occupier or as a rental (Ibem, 2010). The aim of providing affordable housing to low-income families is to provide high-quality homes at lower prices. There are policies and programs regarding Nigeria's mass housing. A pioneer having national coverage is the Shagari housing mass program which was implemented nationally throughout the early 1980s (Ikediashi et al., 2012). Others include the mass housing programs in Kogi State Bilau et al., (2015). These are some amongst others present in different states of the federation.

The difficulties that the Nigerian government and its private sector partners face in providing sufficient housing are aggravated by a lack of understanding of the nature and complexity of the country's housing issues and a limited understanding of the housing need (NBS, 2015). Despite the government's ambitious housing policies since the 1960s, several studies have shown that outcomes have been largely unimpressive, with housing provision falling well short of policy estimates (Ayedun, 2011).

The housing deficit in Nigeria was projected to be between 12 million and 14 million units in 2007 (Akeju, 2007), but by 2008, it had risen to 18 million units (Onwuemenyi, 2008). Urbanization is rapidly increasing, while the housing deficit is predicted to grow at a 3.2% annual rate. For Nigeria, this scarcity of housing represents an opportunity for both increased quantity and improved quality. For most Nigerians however, government-assisted public housing (mass housing) is still the sole cheap housing option (Ayedun, 2011).

## **THE NIGERIAN ECONOMIC SUSTAINABILITY PLAN AND ITS MASS HOUSING PROGRAMME**

The Economic Sustainability Committee (ESC), founded by President Muhammadu Buhari on March 30, 2020, established the NESP, which was accepted by the Federal Executive Council (FEC) on June 24, 2020 (Okoh, 2021). The Cabinet Ministers, Heads of Federal Agencies, The Presidential Economic Advisory Council (PEAC), State Governors, and the National Assembly were involved in the NESP. The Ministerial Committee is to oversee that all parties, especially the public and private sectors, cooperate. The Committee will also oversee the implementation of individual programs and coordinate the entire sectorial value chain and remove any obstructions to performance. The ESC which is in charge of implementation supervision, will provide regular reports to the President (Kolawole, 2020).

To guide Nigeria through the trying times posed by COVID-19, a concerted whole-of-government and whole-of-society campaign is needed. The guiding document to drive the process of overcoming the challenges posed by the COVID-19 is the Nigerian Economic Sustainability Plan (NESP). The NESP aims to promote projects designed to turn adversity into a strategic advantage. Among other opportunities, the NESP will create job opportunities for at least 30 million Nigerians (Kolawole, 2020). Invariably, the NESP is an expression of the determination of the Nigerian government not only to survive but also succeed as a result of the COVID-19 crisis (Okoh, 2021). The goal of the NESP is to minimize the usage of non-local inputs as a conscious decision (Ukpe, 2020). It is designed to protect the disadvantaged population while also presenting opportunities to diverse and entrepreneurial citizens (Kolawole, 2020).

The NESP captures that the Mass Housing Programme is among its key projects. This initiative aims to provide Nigerians with sufficient affordable housing while also generating direct and indirect job opportunities in various sectors (Intel, 2020). The mass housing initiative has a 12-month timetable and a budget of \$317,292,377,973.48, with 1.8 million jobs to be generated. According to (Ukpe, 2020), the NESP equally proposes to build 5 million homes by the private sector. Mass housing projects in the NESP will majorly rely on the use of local products and local labour. Such deliberate effort will indeed make the NESP sustainable.

The initiative's beneficiaries will be entitled to purchase homes with long-term installment options lasting up to 15 years. According to Isaac (2020), the plan will take a two-track approach: reducing bottlenecks in the delivery of social housing while also implementing direct government investments in house development. The Federal Housing Authority (FHA), the FMBN, and the Public Building and Housing Development Programme will collaborate towards delivering this proposed program (Isaac, 2020). The Federal Ministry of Works and Housing, Ministry of Finance, the Central Bank of Nigeria (CBN) and the Family Homes Fund (FHF) are among the project's essential stakeholders. Under this initiative, houses are purchased through cooperatives and warehoused. They are used to secure a mortgage or be rented on a rent-to-own basis, allowing continuous house development across the country (Ajayi, 2020).

Programs within the NESP are designed to enhance and insulate vulnerable individuals and communities (Kolawole, 2020). These vulnerable communities are the majority of people in Nigeria's bottom of the pyramid who are daily-paid and self-employed workers such as bricklayers, vulcanizers, general petty traders, electricians, bus drivers, and barrow pushers among others. In short, The NESP policy has been designed to meet the needs of the most vulnerable Nigerians affected by the COVID-19 pandemic.

### **INTERPERSONAL SKILLS FOR CONSTRUCTION PROJECTS**

A characteristic of construction project is its bringing together different parties who are all required to work together towards successful delivery of the construction project. Parties involved in a construction project come from diverse backgrounds, underwent different trainings and have and varied experiences. As such, the skills they possess are variable. Successful delivery of construction projects requires Project Managers to have certain skills. Specific to interpersonal skills, (Sunindijo & Zou, 2011) reported eight interpersonal skills for the effective management of construction projects which are:

- a. Leadership: The ability to get things done through others;
- b. Team building: The process of helping a group of individuals, bound by a common purpose, to work with each other;
- c. Motivation: Creating an environment to meet project objectives while providing maximum satisfaction related to what people value most;
- d. Communication: Adopting communication styles and techniques that facilitate mutual understanding;
- e. Influencing: Getting others to cooperate towards common goals skillfully and cautiously;
- f. Decision making: Taking decisions that optimally consider time, trust, quality, and acceptance
- g. Political and cultural awareness: Catering for stakeholder's diversity in norms, backgrounds, and expectations;
- h. Negotiation: Conferring with parties of shared or opposed interests with a view towards compromise or reaching an agreement.

In addition to these eight, the (Project Management Institute, 2013) as well as (A Guide to the Project Management Body of Knowledge 6th Edition, 2017) added three which are: which are:

- a. Trust building: Establish positive relationships necessary between the various stakeholders engaged in the project;
- b. Conflict management: Identify the causes for conflict and then actively manage the competition, thus minimizing potential negative impacts; and

- c. Coaching: Developing the project team to higher levels of competency and performance or Help people recognize their potential through empowerment and development.

Although these skills vary across project teams and individuals, (Gamil & Abdul Rahman, 2017) strongly believes that that they play a vital role in the success of a construction project. In other words, they are essential to successful construction project delivery.

## METHODOLOGY

This research intends to obtain objective opinions on interpersonal skills required by built environment professionals towards successful delivery of mass housing projects. According to Pathirage et al. (2008), a survey research strategy is appropriate for obtaining objective opinions. As such this research is designed to collect primary data by means of a survey technique. The data collection instrument suitable for a survey is a questionnaire (Fellows & Liu, 1999; Kasim, 2008). The questionnaire used in this study consists to two sections whereby the first is meant to collect demographic data, the second is designed to collect opinions on a 5-point Likert-type response item which is sequenced as: Not a priority (1); Low priority (2); Medium priority (3); High priority (4); Essential priority (5). Such a priority scale is adopted from (Piper, 2017).

Judgmental sampling is used in selecting the respondents. The claim informs the choice of such a non-probability sample of Fellows & Liu (2008). They recommend its use when a researcher intends to use some informed judgment to determine the population and selection. Similarly, Saunders, Lewis, & Thornhill (2009) recommend judgmental sampling when a researcher wishes to select respondents that are particularly informative in fulfilling the research objectives. Based on such justification, the respondents for this study have undergone education and training in construction courses across several social media professional platforms. Google forms were used as the technique for data collection.

To determine the frequencies, the data will be analyzed descriptively and inferentially using IBM SPSS Statistics 23. Furthermore, MS Excel would be used to compute the Mean Score. This measure has been used in construction management researches whereby John & Itodo (2013), Samuel & Eziyi (2014), Chan & Hou (2015), and also Ejohwomu et al. (2017) express it as:

$$\bar{X} = \frac{\sum X_i}{n}$$

where:  $\bar{X}$  denotes the Mean Score

$\sum X_i$  is the sum of the number of responses and score awarded a variable ( $V_i$ ;  
for  $5 \geq V_i \geq 1$ )

$n$  represents the total number of responses

The Mean Score obtained will be used as a basis to ascertain where each factor studied leans towards in the 5 point scale used (supported by Holt, 2014; Samuel & Eziyi, 2014; and also John & Itodo, 2013). Additionally, MS Excel will be used to compute the Relative Index (RI), which will serve as a basis to rank the level of priority accorded to the interpersonal factors studied. The suitability in using RI is obtained from the works of Aigbavboa & Thwala (2010) and also Olusola (2012), where they express RSI as:

$$RI = \frac{n_1 + 2n_2 + \dots + n_A}{AN} \quad (0 \leq RSI \leq 1)$$

where:

$n_1, n_2, \dots, n_A$  = number of respondents scoring response stem integers 1 to  $A_{max}$  (5), respectively.

$A$  = largest integer on the response item (5 for this research)

$N$  = total number of respondents

Furthermore, the respondent proportion scoring above or below the median value will be calculated. Such analysis helps draw inferences from the scoring profiles for each factor studied (refer to Holt, 2014; Joshi, Kale, Chandel, & Pal, 2015; Bishop & Herron, 2015; Carifio & Perla, 2007; and Harpe, 2015).

## PRESENTATION AND DISCUSSION OF RESULTS

A total of 137 questionnaires were retrieved from the Google forms survey conducted. The subsequent sub sections present and discuss the results of the data analysed.

### Results on respondents' demography

The results on the demography of the respondents are presented in Table 1.

The respondents that constitute the largest group in the survey conducted are Builders constituting 41.60 percent (57). Architects followed these with a proportion of 19.70 percent (27) and then Engineers (Structural/Services) consisting of 14.60 percent (20). Next to Engineers are Quantity Surveyors constituting 10.20 percent (14). These are followed by Urban and Regional Planners making up 8 percent (11). The minimum number of participants in the survey conducted are Land Surveyors, consisting of 5.80 percent (8). These results depict a fair representation of the professionals that are party to the delivery process of mass housing projects.

Relative to the educational qualification of the respondents, the respondents that constitute the largest group in the survey conducted are those with BSc/HND, with a proportion of 44.50 percent (61). Those with an MSc have a ratio of 40.10 percent (55), while those with a PhD have 12 percent (16). The minimum number of participants in the survey conducted are those with Diploma, which constitute 3.60 percent (5).

percent (5). From these results, over 88 percent of the respondents have the opportunity to further their education at BSc/HND, Masters, and PhD levels.

Relative to the years of working experience the respondents that constitute the largest group in the survey conducted are those with ten years and less experience with a proportion of 38 percent (52). These are followed by individuals with 11-20 years of experience, who account for 34.30 percent (47) of the total, and then those with 21-30 years, who account for 22.60 percent (31). The respondents with more than 30 years of experience, who make up 5.10 percent (7) of the total, are the least that participated in this study. From these results, over 72% of the respondents have working experience of 20 years and below which implies they still have decades of professional service.

**Table 1: Results on the demography of respondents**

Profession of respondents	Number of respondents	Proportion/Percentage (%)
Architect	27	19.70
Builder	57	41.60
Land Surveyor	8	5.8
Quantity Surveyor	14	10.20
Urban and Regional Planner	11	8.10
Engineer (Structural/Services)	20	14.60
Total	137	100
Educational qualification of respondents		
PhD	16	12
MSc	55	40.10
BSc/HND	61	44.50
Diploma	5	3.6
Total	137	100
Years of experience of respondents		
10 years and less	52	38
11-20 years	47	34.30
21-30 years	31	22.60
Over 30 years	7	5.10
Total	137	100
Stage of participation in the delivery process of mass housing projects		
Design Only	18	13
Construction Only	47	34
Design and Construction	48	35
None of the Above	24	18
Total	137	100

Relative to the stage of participation in the delivery process of mass housing projects, the respondents that constitute the largest group in the survey are those that have participated in both design and construction with a proportion of 35 percent (48). These are followed by those who have participated in construction only with a ratio of 34 percent (47) and those who have never participated in any stage in the delivery process of mass housing projects with a proportion of 18



percent (24). The minimum number of participants in the survey conducted are those that have participated in design only with a ratio of 13 percent (18). From these results, 82 percent of the respondents have participated in some stage of the delivery process of mass housing construction.

**Results on interpersonal skills**

Table 2 depicts the results of the 11 interpersonal skills studied. While 'decision making' ranked 1st (with a Mean Value of 3.69; RI of 0.74), both 'leadership' and 'communication' ranked 2nd (with a Mean Value of 3.66; RI of 0.73). Also, while 'team building' ranked 3rd (with a Mean Value of 3.58; RI of 0.72), both 'motivation' and 'trust building' ranked 4th (with a Mean Value of 3.55; RI of 0.71). Furthermore, both 'influencing' and 'conflict management' ranked 5th (with a Mean Value of 3.51; RSI of 0.70). Likewise, while 'coaching' ranked 6th (with a Mean Value of 3.42; RI of 0.68), 'negotiation' ranked 7th (with a Mean Value of 3.16; RI of 0.63). Among all the factors, 'political and cultural awareness' ranked 8th (with a Mean Value of 3.06; RI of 0.61).

**Table 2: Results of interpersonal skills**

Interpersonal Skill	Frequency of responses					Total	Scores below median	Scores above median	Mean Score	Relative Index	Rank
	1	2	3	4	5						
	N P	LP	MP	HP	EP						
Decision making	1	8	24	62	42	137	9	104	3.69	0.74	1
Leadership	2	7	27	50	51	137	9	101	3.66	0.73	2
Communication	1	10	25	60	41	137	11	101	3.66	0.73	2
Team building	1	14	27	59	36	137	15	95	3.58	0.72	3
Motivation	5	7	32	54	39	137	12	93	3.55	0.71	4
Trust building	2	13	30	51	41	137	15	92	3.55	0.71	4
Influencing	1	15	34	54	33	137	16	87	3.51	0.70	5
Conflict management	4	14	29	55	35	137	18	90	3.51	0.70	5
Coaching	2	20	34	59	22	137	22	81	3.42	0.68	6
Negotiation	8	22	47	47	13	137	30	60	3.16	0.63	7
Political and cultural awareness	9	24	54	32	18	137	33	50	3.06	0.61	8

Legend: Not a priority (1), Low priority (2), Medium priority (3), High priority (4), Essential priority (5)

From the results of the scores below the median and the scores above the median, although 'leadership' and 'communication' recorded the same rank (2nd), the respondents that place more priority on 'leadership' are marginally more in number compared to those that place significant emphasis on 'communication.' Likewise, although 'motivation' and 'trust building' both ranked 4th, responders that place greater importance on 'motivation' are slightly more in number to those on 'trust building'. Although 'influencing' and 'conflict management' got the same rank (5th), respondents who emphasize 'influencing' are marginally more

significant in number. Results also show that not up to half of the respondents set priorities on 'negotiation' as well as 'political and cultural awareness'.

## CONCLUSION AND RECOMMENDATIONS

The built environment professionals surveyed allude that none of the factors studied is of essential priority. Similarly, their response reveals the following interpersonal skills being of higher priority: decision making; leadership; communication; team building; motivation; trust-building; influencing, and conflict management. Overall, more attention must be given to the interpersonal factors coaching, negotiation, and political and cultural awareness. For successful delivery of mass housing projects, this is essential, particularly considering the fact that most respondents have the opportunity to further their education at BSc/HND, Masters, and PhD. Similarly, the respondents covered in this study still have about two decades of professional service. Because of the low priority given to political and cultural awareness in this study, (Sunindijo & Zou, 2011) assert that, while political skill is often overlooked, successful Project Managers must understand the importance of maintaining solid political ties to achieve project success. In other words, politics can significantly positively impact the success of construction projects in general but mass housing projects in particular. The implication of this study may imply that, to successfully deliver mass housing projects like the Mass Housing Programme proposed in the NESP, academic institutions, construction firms, and professional bodies must invest more in education and training programs supporting and facilitating coaching, negotiation, and, most importantly, political and cultural awareness. The interpersonal factors covered in this study are not all encompassing. Future studies may cover emotional human-related factors essential to the successful delivery of large-scale construction projects. Similarly, other techniques of data collection if used to study interpersonal factors may present results that may differ from those obtained in this study. Likewise, other respondents with varied opinions may reveal findings contrary to this study.

## REFERENCES

- Ahadzie, D. K. D. G. Proverbs, & P. O. Olomolaiye, (2008). "Critical success criteria for mass house building projects in developing countries," *International Journal of Project Management*, vol. 26, no. 6, pp. 675–687.
- Ahadzie, D. K. D. G. Proverbs, & I. Sarkodie-Poku, (2014) "Competencies required of project managers at the design phase of mass house building projects," *International Journal of Project Management*, vol. 32, no. 6, pp. 958–969.
- Ajayi, O. (2020). FG moves to construct 300,000 housing units for low-income earners. Retrieved March 24, 2021, from nairametrics: <https://nairametrics.com/2020/12/15/fg-moves-to-construct-300000-housing-units-for-low-income-earners/>
- Akeju, A. A., "Challenges of providing affordable housing in Nigeria" a paper presented at the 2nd Emerging Urban Africa International Conference on Housing Finance in Nigeria held at Shehu Yar'adua centre Abuja October 17-19, 2007.
- Anyanwu, C. I. (2013). The role of building construction project team members in building projects delivery. *IOSR Journal of Business and Management*, 14(1), 30- 34

- Ayedun, C. A., & Oluwatobi, A. O., (2011), Issues and challenges militating against the sustainability of affordable housing provision in Nigeria, *Business Management Dynamics*, 1, 1-8.
- Bates T. (2016). Teaching in a Digital Age. Retrieved from <http://opentextbc.ca/teachinginadigitalage/wpcontent/uploads/sites/29/2015/04/Scenario-A.mp3>, accessed: 29/03/2021
- Bolaji, F. (2020, May 17). List of universities in Nigeria as approved by NUC-2019: Latest release. *Campusbiz Journal*. Retrieved from <https://campusbiz.com.ng> (accessed on 26 March 2021)
- Dulaimi, M. F. (2005). The influence of academic education and formal training on the project manager's behavior. *Journal of Construction Research*, 6(1): 179–193.
- Folaranmi, A. O., (2012) Mass Housing in Nigeria, Customize the Brief: Provide a Desired House, *Journal of Civil and Environmental Research ISSN 2222-1719 Vol 2, No.4*.
- Hussin, A. A., & Omran, A. (2009, November). Roles of professionals in the construction industry. Paper presented at the International Conference on Economics and Administration, Bucharest
- Ibem, E. O., & Amole, O. O., (2010), Evaluation of public housing programmes in Nigeria: A theoretical and conceptual approach, *The Built Environment Review*, 3, 88-116.
- Intel, E. (2020). Delivering Mass Housing As a Path To Nigeria's Economic Recovery. Retrieved March 24, 2021, from *nairametrics*: <https://nairametrics.com/2020/07/14/delivering-mass-housing-as-a-path-to-nigerias-economic-recovery/>
- Isaac, T. (2020). Assessing FMBN's Post Covid-19 Housing Delivery Plan. Retrieved March 24, 2021, from *thisdaylive*: <https://www.thisdaylive.com/index.php/2020/09/10/assessing-fmbns-post-covid-19-housing-delivery-plan/>
- Jacobs, E. (2015). The status quo of green-building education in South Africa. *Acta Structilia: Journal for the Physical and Development Sciences* 22(2): 110-133.
- Jin, R., Yang, T., Piroozfar, P., Kang, B. G., Wanatowski, D., Hancock, C. M., & Tang, L. (2018). Project-based pedagogy in interdisciplinary building design adopting BIM. *Engineering, Construction and Architectural Management*.
- Joint Admission & Matriculation Board [JAMB] (2021). Retrieved from <https://www.jamb.gov.ng>.
- Jiboye, A. D., (2009), Evaluating tenants satisfaction with public housing in Lagos, Nigeria, *Town Planning and Architecture*, 33(4), 239-247.
- Kolawole Y. (2020). FG has started implementing Economic Sustainability Plan — Osinbajo March, 29 2021. Retrieved from <https://www.vanguardngr.com/2020/08/fg-has-started-implementing-economic-sustainability-plan-osinbajo/>
- Zairul, M. M. N., & Rahinah, I. (2011) "Identifying concurrent engineering (CE) elements or mass housing industry," *Journal of Advanced manufacturing technology*, vol. 5, no. 1, pp. 61–78,.
- National Bureau of Statistics [NBS] (2015). Nigerian construction sector: Summary report; 2010-2012. Retrieved from <https://nigerianstat.gov.ng>.
- National Bureau of Statistics [NBS] (2019). Nigerian construction sector: Summary report; March 29, 2021. Retrieved from <https://nigerianstat.gov.ng>

- Nghai E. S., & Musa L. I. S. (2012). The Implications of User Redesigns of Public Housing on the Architectural Design Process West Africa Built Environment Research (WABER) Conference pp 1329-1340
- Noorzai, E., & Golabchi, M. (2020). Selecting a proper construction system in small and medium mass housing projects, considering success criteria and construction volume and height. *Journal of Engineering, Design and Technology*.
- NPC, 2006, National Population Census of Nigeria, Federal Republic of Nigeria.
- Odusami, K. T. (2002). Perception of construction professionals concerning important skills of effective project leaders. *Journal of Management in Engineering*, 18(2): 61–67.
- Okoh, A. S. (2021). Aligning the New NDC with NESP. In *Oil Mortality in Post-Fossil Fuel Era Nigeria* (pp. 205-225). Springer, Cham.
- Onwuemenyi, O., (2008)“ Nigerian Housing sector”, Punch, 29th January, Punch Newspapers Nigeria.
- Owolabi, O. S. B., & Olatunji, A. S. (2014). The roles of construction professionals in the Nigeria’s construction industry. *IOSR Journal of Humanities and Social Science*, 19(11), 5-10.
- Russell, J. S., & Stouffer, B. (2003). Leadership: Is it time for an educational change? *Leadership Management in Engineering*, 3(1): 2–3.
- Ukpe, W. (2020). FEC approves NESP’s N2.3 trillion stimulus plan. Retrieved March 29, 2021, from nairametrics: <https://nairametrics.com/2020/06/25/fec-approves-nesps-n2-3-trillion-stimulus-plan/>
- Waldigit C. (2013). The roles of professionals in the construction industry. Retrieved from <http://www.nairaland.com/therolesofprofessionalsintheconstructionindustry/waldigit>.
- Zairul, M. M. M., & Rahinah, I. (2011). Identifying concurrent engineering (CE) elements for mass housing industry. *Journal of Advanced Manufacturing Technology*, 5(1), 61-78.



---

## ADOPTION OF TECHNOLOGY IN HUMAN RESOURCE MANAGEMENT - A NEW NORMAL

Kuforiji, A. Aramide<sup>1</sup>, Eze, B. Daniel<sup>2</sup> and Fajana, Sola<sup>3</sup>

<sup>1</sup>*Industrial Relations and Personnel Management, Olabisi Onabanjo University, Nigeria*

<sup>2</sup>*Business Administration, Christopher University, Nigeria*

<sup>3</sup>*Employment Relations and Human Resources Management, University of Lagos, Nigeria*

The COVID-19 pandemic has disrupted socio-economic activities globally. In the same vein, police brutality, Black life matters in the US and ENDSARS protest in Nigeria re-emphasized the importance of technological advances in business activities. Before this period, businesses in Nigeria have been skeptical in using technology to run businesses, as employees have to resume work by 8:00am and leave after 8 hours of work. However, with the advent of COVID19 and ENDSARS protests, working from home with flexible work hours that are being practiced in technologically advanced economies is now becoming the new normal in Nigeria. This study examines the effect of technology adoption on human resource practices in selected manufacturing firms in Lagos and Ogun States, Nigeria. The study employed survey research design, through the administration of structured questionnaire on selected members of staff of the selected manufacturing firms. The findings reveal that e-hr implementation has a positive significant effect on HR practices with a coefficient of 0.5612 (p-value <0.05). However, the findings further reveal that technology adoption has a negative significant effect on employees' collaboration and bonding. It can therefore be concluded that while e-hr has positively affected HR practices, technology adoption has negatively affected employees' collaboration and bonding. It is recommended that engagement strategies should be adopted by management to facilitate collaboration and bonding among employees while implementing e-HR in the organization.

Keywords: collaboration, COVID-19 pandemic, e-HR, emotional intelligence (EI), workplace

### INTRODUCTION

Change is the only constant thing in life and can either be disruptive or constructive. In whatever form it comes, innovation, renovation and creation are imminent afterwards. The transformation of HR today is a natural extension of changes occurring more broadly within firms. Globalization, diversity, intellectual capital, information technology, COVID19 pandemic, ENDSARS and the like are expanding the scope of organizations, accelerating the rate of change, and placing

---

<sup>1</sup> aramide.kuforiji@oouagoiwoye.edu.ng

<sup>2</sup> beneze7@gmail.com

<sup>3</sup> fajana@unilag.edu.ng

a premium on organizational agility, flexibility and rapid response of the Human Resource Management to the pace of change (Snell, Stueber, & Lepak, 2001). The current COVID-19 pandemic has in a way affected various sustainable developmental goals mostly in areas such as poverty reduction, shrinking inequalities and social inclusion encouragement. (UN 2020; Buheji and Ahmed, 2020; Ahmad et al., 2021).

HR departments are being charged with being simultaneously strategic, flexible, cost-efficient, and customer-oriented. Unfortunately, the evidence suggests that traditional models of HR are poorly suited for these challenges. Critics charge that HR departments are often the last bastions of bureaucracy in organizations, and that the command and control approaches they use actually impede rather than facilitate progress to strategic goals. Although these limitations of traditional HR functions have always been there, recent health emergencies and societal unrest like the COVID-19 pandemic, police brutality, Black life matters in the US and ENDSARS protest in Nigeria have re-emphasized the urgent need for technological adoption in rightly and promptly responding to the ever-increasing global business opportunities. Businesses in Nigeria have hitherto been skeptical in using technology to run, as employees before now have to resume work by 8:00am and leave after 8 hours work. However, with the advent of COVID-19 and ENDSARS protests, working from home with the use of technological tools and internet have now become the new normal in Nigeria. Buheji and Ahmed (2020) postulated that a lot of corporate, business and social activities would become virtual under the new normal, and as such, many physical businesses would change their means of services 'delivery to more technologically-driven methods.

Old-economy companies attempt to fit into the new economy with the use of Internet to expand and improve their current collaborative relationships among their stakeholders however there is lack of reliable data on the people issues arising from a move from a traditional brick-and-mortar business model to an e-business model (Snell, Stueber, & Lepak, 2001). Moreso, Buheji and Ahmed (2020) identified the psychological impact of implementing technologically-driven systems to manage the organisation's human resource in the new normal as gap in literature that other researchers should explore. Based on this the objective of the study is to examine the effect of technology-driven initiatives like zoom meeting and Facebook chat room in managing human resource in the manufacturing businesses in Lagos State, Nigeria. The questions this paper answered are;

1. What is the effect of e-HR/HRIS on the way the human resource is being managed in selected manufacturing companies in Lagos State, Nigeria?
2. What effects does technological adoption in HR practice have on employees' collaboration and bonding, retaining of new talents and overall emotional/mental wellness in selected manufacturing companies in Lagos State, Nigeria?

The attendant hypotheses tested were:

1. There is no significant effect of e-HR/HRIS implementation on HR practices.

2. There is no significant effect of the technological adoption made in HR practice on the employees 'collaboration and bonding.

## **REVIEW OF LITERATURE**

This section focused on empirical reviews concerning the new normal perspective on post-COVID-19, technology adoption and human resource.

### **The new normal**

Currently, globalization, diversity, intellectual capital, information technology are increasing organisational operating space, accelerate the pace of change, and place premium on organizational agility, flexibility and rapid response. Today, firms compete more on capabilities, relationships, new ideas and have discovered the importance of collaborating with all stakeholders both internal, external partners as well as maximize the use of technology. Doing this, allows them to focus resources and their expertise, integrate knowledge from the outside, react quickly to arising opportunities, and deliver better value to customers in the midst of either environmental, economic or health hitches that may be encountered (Snell, Stueber, & Lepak, 2001).

Virtual working, Teleconferencing and flexible working have been in existence long before the advent of COVID-19. However, the pandemic activated most organisations into their importance. Buheji and Ahmed (2020) stated that the New Normal started with the outbreak of COVID-19 pandemic in Asia, and spreading over many nations of the world, with very limited facility for effective suppression. The pandemic disordered trade and industry activities, social life, and endangered basic socio-economic principles. Ozili and Arun (2020) believe that the global health implications of Covid19 pandemic would lead to more economic hardship, arising from national and international travel bans, monetary procedure alteration, additional restrictive processes and unrelenting vacillation in global stock market.

Ambrosi De la Cadena (2020) assert that the pandemic has brought to the fore, many technology-driven opportunities which had reshaped work roles views. One of the envisaged features of the new normal as prompted by the Covid19 pandemic is the change in the mind-set of the entrepreneurs about how to run a successful business.

### **Technology adoption**

Frederick Winslow Taylor developed the scientific management theory at the turn of the industrial revolution and has successive improved the manual labour practices that existed before the industrial revolution. Technological mechanisms in organisations speed workflow processes, giving employees the ultimate resource – more time – to focus on the important work, and in turn, make the communication process within the organisation more effective and efficient. However, technological adoption in HR Practice is not without its downside issues. Unlike face-to-face work environs, communication through technology creates barriers and limits honest interactions. There are also the valid concerns of data safety, misdeeds and violence, communal cut off, confidentiality abuse, overwork, manoeuvring of digital media and job uncertainty (Thompson and McHugh, 1995 p.32).



Ozili and Arun (2020) opine that COVID19 pandemic has triggered the introduction of various hi-tech appliances, which were not in use pre Covid19 pandemic, into the manufacturing and production activities globally. Buheji and Ahmed (2020) mentioned that the COVID19 transformed every aspect of human life, having a huge impact on e- learning, remote-working and e-commerce, with its both hurtful and helpful implications on various sectors of the world economy.

### **Human resource**

Information Technology has been a veritable tool in Human Resource Management and Practice for several years, with its usage being intensified and its roles being expanded with Human Resource developments. (Sharma, 2020). The term e-HRM was first used in the late 1990s when e-commerce was sweeping the business world and e-HRM was seen as an internal application of e-business techniques. It helps the management in a more effective and efficient flow of information and method of doing HRM. Organizations could manage an increasing number of HRM processes effectively with enhanced information technology, thus contributing to the accessibility of information and knowledge. This also assisted HRM professionals in playing a strategic role in attaining enhanced competitive benefit. Drawing, preserving and encouraging employees, meeting demand for a more calculated HR function and overseeing the "human element" of technological alteration in the future have all been facilitated by advancement in IT to meet the challenges of Human Resource Management (Ashbaugh and Miranda, 2002).

HRM can live up to expectation by concurrently becoming more bendable, cost-efficient, tactical and customer-oriented through the power of information technology (Lengnick-Hallet al., 2009). Worldwide economies and businesses were disrupted by the COVID-19 pandemic and Human Resources (HR) has been at the heart of it. Now that most organisations are at the recovery stage, the role of HR is much more important than before (Bashoun, Braik and Kassis 2020). Sneader and Singhal (2020) opine that post COVID-19, livelihoods of many people will change as both commerce and trade are likely to experience swift reorganization in both the technological, socio-economic and political precedence. With the advent of COVID19, every business framework is open to questioning in order to arrive at its best. With the drastic change in both the standard and cost of living, occasioned by the outbreak of COVID19 pandemic, the mind-set of people will not be the same again. Both the social and economic structures would progress towards computerization. The automated system would be moving across different business models, where every worker becomes a skilled worker (Buheji, 2020). Gigauri(2020) declares that as businesses focus on the convalescence after the pandemic, which was consumed by disruption of jobs, automation, and changing workforce demographics, the worker's wellbeing is a priority.

### **Theoretical framework**

Emotional intelligence theory postulated by Mayer, Salovey and Caruso (2004) as a type of social intelligence, separable from general intelligence, which involves the ability to monitor one's own and others' emotions, to discriminate among them, and to use the information to guide one's thinking and actions. In a later attempt, they expanded their model and defined EI as the ability of an individual to perceive accurately, appraise, and express emotion; the ability to access and/or generate feelings when they facilitate thought; the ability to understand emotion

and emotional knowledge; and the ability to regulate emotions to promote emotional and intellectual growth (Lam and Kirby, 2002)

Arora (2017) defined Emotional intelligence as someone's ability: (a) to understand his feelings, (b) to listen to others and to feel them, and (c) to express his emotions in a productive manner. The rationale for using Mayer, Salovey and Caruso (2004); Goleman (1998) EI principle stems from the understanding that in the new normal some skill sets will become dormant/latent due to emergence/ use/ advent of Artificial Intelligence in the work place. Although robotic will take over some jobs, the human's role would not be taken away completely (Belsky, 2020; Hessman, 2020). Therefore, the organisation's leaders' ability to adopt emotional intelligence skills while implementing the new technological way of working will engender positive employee engagement within the organisation (Suehs, 2015).

## METHODOLOGY

Snell, Stueberand Lepak(2001) and Buheji and Ahmed (2020) suggested that there is need to investigate technological adoption in HR practice, The cross-sectional survey research design was employed and the manufacturing organization was the focus of the study with the Western Region of Nigeria as the scope.

The population of the study comprises of members of staff of Cadbury Nigeria PLC, Nestle Nigeria PLC and PZ Cussons Nigeria PLC. The three firms were selected because they are among the top ten manufacturing firms, quoted on the Nigerian Stock Exchange. The numbers of employees of the three selected firms are stated below:

**Table 1: Numbers of Employees of the Selected Firms**

S/N	Name of Company	Number of Employees
1	CADBURY NIGERIA PLC	1,797
2	NESTLE NIGERIA PLC	3,300
3	PZ CUSSONS NIGERIA PLC	4,476
	TOTAL	9573

Source: Author's compilation from the firms' website

The study employs Survey System Sample Size Calculator at 95% confidence level and margin of error of 7, which gave a sample size of 192. This study employed stratified sampling as well as simple random sampling. The population was divided into three strata based on the three companies and a simple random sampling was carried out in each stratum.

The questionnaire items were in 5-point Likert scale structured as Strongly Agreed (5), Agreed (4), Indifferent (3); Disagreed (2) and Strongly Disagreed (1) which included questions on (1) Respondents Level of Experience (2) e-HR, (3) Technology adoption. Questions on e-HR were adapted from Loon, Otaye-Ebede and Stewart, (2020) while Technology adoption was from Sharma (2020) and its validity and reliability were established. Copies were administered to simple randomly selected Human Resource managers and management team of selected manufacturing companies in Lagos State, Nigeria. Linear Regression method of data analysis was used. One hundred and ninety two copies of questionnaires were

administered on the selected respondents. However, only one hundred and fifty four copies were properly completed and found useable. This represent 80.2% response rate.

## Results

Table 2 indicated that 20% of the respondents have been working with their firms for less than 5years, while 74% of the respondents have been working with their firms for between 5-9 years. Furthermore, 6% of the respondents 'years of experience range from 10years and above. This implies that 80% of the respondents have a minimum of 5 years of working experience. Therefore, the respondents are relatively conversant with their firms' operations and information provided by the respondents can be relied upon, since they are conversant with their firms 'operation.

**Table 2: Respondents Level of Experience**

Years of Experience	Frequency	Percentage
Less than 5years	31	20%
5-9 years	114	74%
10years and above	9	6%
Total	154	100%

Source: Field Survey (2020) Authors 'Computation from SPSS 23

## Hypotheses testing

Ho1: E-HR does not have a positive significant effect on HR practices in manufacturing firms.

**Table 3: The regression result for hypothesis 1 (HR Practices)**

Variable(s)	Coefficient	T	P-Value
Constant	6.673	7.452	0.000
e-HR	0.5612	4.932	0.000
F-Stat=24.342(0.000)			R-Square= 0.293

Source: Field Survey (2020) Author's Computation from SPSS 23

The result in table 3 revealed that e-HR implementation significantly affects the HR practices of manufacturing firms. This can easily be deduced from the coefficient and probability value (0.5612, P-value <0.05), which is less than the 5% (0.05) level of significance. Therefore, the null hypothesis was rejected while the alternative hypothesis was accepted. Furthermore, the F-stat showed that the model is fit for prediction and decision-making. The R<sup>2</sup> (0.293) indicates that e-HR implementation accounts for 29.3% change in HR practices.

Ho2: Technology adoption does not have a significant effect on employees' collaboration in manufacturing firms

**Table 4: The regression result for hypothesis 2 (Employees' Collaboration)**

Variable(s)	Coefficient	T	P-Value
Constant	5.039	3.202	0.002
Technology adoption	-0.555	-6.342	0.000
F-Stat= 41.502(0.000)			R-Square= 0.419

Authors 'Computation from SPSS 23Source: Field Survey (2020)

The result in table 4 revealed that technology adoption has a negative significant effect on employees collaboration of manufacturing firms, this can easily be deduced from the coefficient and probability value (-0.555, P-value < 0.05), which is less than the 5% (0.05) level of significance. Therefore, the null hypothesis will be accepted while the alternative hypothesis will be rejected. Furthermore, the F-stat showed that the model is fit for prediction and decision making. The R<sup>2</sup> (0.419) indicates that technology adoption accounts for 41.9% change in employees collaboration.

## **DISCUSSION OF FINDINGS**

The advent of COVID-19 which had a global presence, police brutality in the US, ENDSARS in Nigeria has reinforced the axiom "the only constant in life is change" because change is a fact of organizational life, just as it is in human life. From the findings of this study, the researchers found that adoption of e-HR in the selected manufacturing organization during the COVID-19 pandemic era in Nigeria has further led to technologically-driven HR practices.

From the findings of this study, the employees of selected manufacturing firms in Lagos State, Nigeria felt that e-HR is effectively implemented in their organizations. The organizational culture is gradually being eroded due to the virtual mode of working. The result of this the study is in line with the study conducted by Karanja (2015), changes in organizational structures due to technological advancement, such as downsizing, mergers, and acquisitions not only affect employee numbers in an organization, but can also radically affect factors such as management style, organizational culture, and employee commitment and performance.

Employees in the selected manufacturing firm in Lagos State, Nigeria from this study revealed that technology adoption does not encourage collaboration, therefore, indicating that the emotional and mental wellness of staff were not probably adequately considered during policy formulation. This finding corroborates finding of Rashid, Sambasivan and Rahman (2004), that people are the most important factor in making change, and however, they are also the most difficult element to deal with. Therefore, managing the human part of the organization becomes a major challenge in handling change processes in the organization as it involves values, preferences, and attitudes toward a particular activity.

A study conducted by Sunindijo and Zou (2013) has shown that to effectively work in a team to achieve high organizational performance, emotional intelligence competence is a vital requirement. However, EI is not only the ability to control one's feelings, it is also the ability to understand other people by learning to recognize someone else's experiences and show empathy. The study revealed that implementing technologically-driven HR practices in companies in the Western Region of Nigeria does not encourage employee collaboration. The leadership while formulating policies in the new normal should "penetrate the inner world" of colleagues to engender a feeling of unity, a feeling that both the leader and follower are - at one wave (Sneider and Singhal, 2020).

The study revealed that the rate of technologically-inclined talents inflows into the organization has increased due to the COVID-19 pandemic, sociological happenings around the globe and the deployment of e-HR practices which have reduced the number of workforces to give room for light overhead. In the new normal, automation has changed the world of work. The new robot generation has a different purpose: to overcome both the physiological and psychological limitations of human beings. However, the few talents that will be available to work in this dispensation are expected to be filled with ideas, insights, perspectives and abstract creative genius that no machine and no software can duplicate (Hessman, 2020).

## **CONCLUSION AND FUTURE RESEARCH**

Literature has emphasised the fact that Human Resources are the most significant and vital input for the success of any organization. To thrive in the new normal, the HR function must inculcate technological literacy as a requirement. The roles and skills of HR managers have grown considerably in recent times due to the adoption and use of new technologies. The managers are now able to perform the traditional functions of procurement, maintenance, development and utilization more effectively and efficiently. Human resource managers can now take up more challenging roles in organizations. The growing use of information technology in human resource has significantly increased the efficiency of HR management activities and processes, increased their speed and reduced associated costs.

Technology cannot displace man in the workplace; however, the need for man to collaborate effectively has been discovered to be a necessity. The study, recommends that engagement strategy should be adopted by management to facilitate collaboration and bonding among employees while implementing e-HR in the organization. Further studies to test the research variables in other sectors like service, banking and construction, would make for better generalization of the outcomes.

## **REFERENCES**

- Ahmad, N., Mahmood, A., Han, H., Ariza-Montes, A., Vega-Muñoz, A., Din, M., Khan, G. I. & Ullah, Z. (2021). Sustainability as a "new normal" for modern businesses: Are SMEs of Pakistan ready to adopt it?, *Sustainability*, 13(4),2-7.
- Ambrosi, D., & Cadena, M. (2020). Labour and consumption. A new opportunity for capitalism resulting from the COVID-19 pandemic. *Religación. Revista de Ciencias Sociales y Humanidades*, 5(26), 188-198.
- Arora, B. (2017). Importance of emotional intelligence in the workplace. *International Journal of Engineering and Applied Sciences*, 4(4), 43 – 45.
- Ashbaugh, S., & Miranda, R. (2002). Technology for human resource management: Seven questions and answers. *Public Personnel Management*, 31(1), 7-20.
- Bahsoun, R., Braik, K. B., & Kassis, B. (2020). How the new normal is shaping the future of HR. Retrieved from <https://tinyurl.com/rvszhapd> on 24 February 2021.
- Belsky, S. (2020). Creativity will be key to competing against AI in the future workforce - here's how', Retrieved from <https://tinyurl.com/yytlmmh8> on January 2021.

- Buheji, M. (2020). Future foresight of post COVID-19 generations. *International Journal of Youth Economy*, 4(1), 1 - 3.
- Buheji, M., & Ahmed, D. (2020). Planning for 'the new normal' foresight and management of the possibilities of socio-economic spill-overs due to COVID- 19 Pandemic. *Business Management and Strategy*, 11(1).
- Buheji, M., & Ahmed, D. (2020). Foresight of coronavirus (COVID-19) opportunities for a better world. *American Journal of Economics*, 10(2), 97-108.
- Dongrie, V., Chatterjee, S., Acharya, B., Venkatesh, A., Choudhary, R., & Tulpule, S. (2020). Cutting edge through crisis KPMG in India's COVID-19 HR practices survey report. retrieved from <https://tinyurl.com/45vpsdcy> on January 16 2021.
- Gigauri, I. (2020). Implications of COVID-19 for human resource management SSRG *International Journal of Economics and Management Studies*, 7 (11), 25-33.
- Goleman, D. (1998) *Working with emotional intelligence*. New York: Bantam.
- Hessman, T. (2020). Robots, humans and the future of work', Retrieved from <https://tinyurl.com/yymn2dw7> on 11 November 2020.
- Karanja, A. (2015). Organizational change and employee performance: A case on the postal corporation of Kenya', *European Journal of Business and Management*, 7(11), 232 – 241.
- Lam, L. T., & Kirby, S. L. (2002). Is emotional intelligence an advantage? An exploration of the impact of emotional and general intelligence on individual performance', *Journal of Social Psychology*, 142(1), 133 – 143.
- Lengnick-Hall, M. L., Lengnick-Hall, C. A., Andrade, L. S. & Drake, B. (2009). Strategic human resource management: The evolution of the field. *Human Resource Management Review*, 19, 64–85
- Loon, M., Otaye-Ebede, L. & Stewart, J. (2020). Thriving in the new normal: The HR micro-foundations of capabilities for business model innovation: An integrated literature review. *Journal of Management Studies*, 57(3), 698 – 726.
- Mayer, J., Salovey P., & Caruso, D. (2004). Emotional intelligence: Theory, findings and implications', *Psychological Inquiry*, 15(3), 197 – 215.
- Ozili, P., & Arun, T. (2020). Spillover of COVID-19: Impact on the global economy', *SSRN Electronic Journal*, Retrieved from <https://tinyurl.com/y57btug2> on November 2020.
- Rashid, Z. A., Sambasivan, M., & Rahman, A. A. (2004). The influence of organizational culture on attitudes toward organizational change. *Leadership & Organization Development Journal*, 25(2), 161-179.
- Sharma, R. (2020). Technological Disruptions in HR. *Journal of Information and Computational Science*, 13(10), 95 – 103.
- Sneader, K. & Singhal, S. (2020). From thinking about the next normal to making it work: What to stop, start, and accelerate. Retrieved from <https://tinyurl.com/ffbtwkam> on January 15, 2021
- Snell, S. A., Stueber, D., & Lepak, D. P. (2001). Virtual HR departments: Getting out of the middle. CAHRS Working Paper Series. Paper 71. Retrieved on 18 June 2021 from <http://digitalcommons.ilr.cornell.edu/cahrswp/71>

- Sunindijo, R. Y., & Zou, P. X. W. (2013). The roles of emotional intelligence, interpersonal skill, and transformational leadership on improving construction safety performance', *Australasian Journal of Construction Economics and Building*, 13 (3) 97-113
- Suehs, D. (2015). Emotional intelligence and employee engagement: a quantitative study to explore the relationship between the emotional intelligence of frontline managers and supervisors and the degree of employee engagement of their direct reports in a tertiary care health care setting. Education Doctoral. Paper 239.
- Thompson, P., & McHugh, D. (1995). *Work organisations a critical introduction*: Houndmills, Basingstoke, Hampshire RG21 6XS and London Macmillan Press Ltd
- UN. (2020). The social impact of COVID-19, United Nations, Retrieved from <https://tinyurl.com/wf5vrn6w> on 07/01/2021



# ADVANCEMENTS IN COMPUTER-AIDED DESIGN AND THE CHALLENGES FOR ARCHITECTURAL EDUCATION IN NIGERIA – FEEDBACK FROM THE STUDENTS' INDUSTRIAL WORK EXPERIENCE SCHEME

Sunday A. Bobadoye<sup>1</sup>, Dorcas A. Ayeni<sup>2</sup>, Saidat D. Olanrewaju<sup>3</sup> and Ajenifujah-Aminat O. Ajenifujah-Abubakar<sup>4</sup>

<sup>1,2,3,4</sup>*Department of Architecture, Federal University of Technology Akure, Nigeria*

The paper examines the challenges that revolutionary advancements in Computer-Aided Design (CAD) pose to architectural education against the background of widespread applications of computers to architectural practice in twenty-first Century Nigeria. Architectural education as universities in Nigeria are offering it has not adequately responded to the challenge of equipping students to cope with computer applications to architecture and construction. On the other hand, design and modelling operations in architecture and construction establishments are mostly done in CAD. Using a structured questionnaire as research instrument, this paper seeks to answer some questions: 1. What CAD knowledge does the architecture school provide? 2. What CAD competency do students possess, and how were they acquired? 3. Was CAD competency required to secure internship placements? Feedback from the mandatory Student's Industrial Work Experience (SIWES) program undertaken by fourth-year students of the Department of Architecture, Federal University of Technology Akure, Nigeria (FUTA), was used to gauge students' preparation and expectations from architecture and construction establishments. The questionnaire administered on sixty randomly selected students was used in eliciting data and serves as feedback on which this study was anchored. Content analysis was used to analyse the data obtained. Results from the survey revealed that the current curriculum does not provide the students with adequate CAD competency to meet architectural workplaces' challenges. However, CAD competency was significant in securing SIWES placements, and self-help measures were the primary means to acquire CAD competency. The study suggests the collaborative design of a Twenty-first Century relevant CAD curriculum, establishment and maintenance of functional CAD laboratories, re-skilling and up-skilling of educators to equip architecture students for the profession's CAD realities.

Keywords: architectural education, CAD, curriculum, students' industrial work experience scheme

<sup>1</sup> sabobadoye@futa.edu.ng; adebobadoye@gmail.com

<sup>2</sup> daayeni@futa.edu.ng

<sup>3</sup> olanrewajuso@futa.edu.ng

<sup>4</sup> aoajenifujah-abubakar@futa.edu.ng



## INTRODUCTION

In the last three decades of the twentieth century, advancements in computer technology brought about sweeping changes in the way modern society learn, work and play. Further developments in the early years of the twenty-first century in Information and Communication Technology (ICT) have effectively transformed the world into a global information space causing revolutionary changes in workplaces. In contemporary Nigeria, the architectural profession has been inextricably drawn into the vortex of Information technology. The demand and realities of the local and global workplace have made it inevitable for practicing architects, architectural educators and students in Nigeria to seek proficiency in computing (Ogunsote and Prucnal-Ogunsote, 1987; Ogunsote, 2001; Bobadoye, 2002; Ogunsote and Prucnal-Ogunsote, 2006; World Economic Forum, 2016).

In line with global trends, architecture practitioners and construction establishments in Nigeria have embraced ICT; they are continually investing in new machines and software. Most reputable architecture firms and establishments in the country have been computerized, and the use of Computer-Aided Design (CAD) to accomplish tasks in the design process for conception, drafting, presentation, documentation and project management is now widespread. However, there seems to be a mismatch in what architecture establishments require and what architecture schools in Nigeria offer in terms of interns or graduates' CAD competency. As it is being taught in Nigeria Universities, architecture has not adequately responded to the challenges posed by dynamic advancements in Computer Technology and the increased deployment of CAD in architectural practice. In the 1980s and 1990's most Schools of architecture in the country lacked the wherewithal to produce CAD proficient architects, and so most architects learnt CAD outside of school. How much has the situation changed in the post year 2000 era? What are the challenges and prospects of producing CAD proficient architects by architecture schools in Nigeria? Ogunsote et al. (2006) provided insights into the other posers. First, the significant production of CAD proficient graduates by Nigeria's architecture schools will require a comprehensive review of the curriculum to make CAD an integral part of the training programme. Second, if resources are carefully planned and utilized, CAD proficient graduates' production is possible because global trends and improvements in computer technology have led to lower costs of hard and software.

The quintessence of qualitative education is to equip students for future tasks adequately and perform societal building roles effectively. This study is important because it sought to identify if there is gap between the CAD knowledge the formal architecture school exposes the students to and the level of competency expected from interns by architecture establishments and how such gaps are been bridged if they exists. It is indeed essential for stakeholders in architectural education to identify and fashion out means of bridging the gap between school and practice in the area of computer applications to architecture, especially Computer-Aided Design (CAD). In the light of the foregoing, this paper seeks to answer some questions: 1. What CAD knowledge does the architecture school provide? 2. What CAD competency do students possess, and how were they acquired? 3. Was CAD competency required to secure internship placements in architecture and construction establishments?

## **ADVANCEMENT IN CAD AND ARCHITECTURAL PRACTICE**

Over the years, the use of computers in architecture has been dynamic. According to Rabee (2006), "it was first envisioned as a sophisticated simulation machine and then a repository of accurate and comprehensive records of buildings." On their part, Akin and Anadol (1993) opined that the computer was not seen as a replacement for other things such as draftsmen, hard copy documents and organizations. They instead considered it a "medium," no more no less, and then as a collaborator in the design process in which the computer and the humans complement each other's weaknesses.

In exploring the integration of digital design and architecture during the past three decades, Andia, (2001) revealed that architectural firms adapted their CAD skills in three distinctive eras: first, the CAD on Mainframe Era; second, the CAD Operator Era; and third, the High Computer Literacy era. This third wave ushered in introducing the personal computer and PC CAD to architectural firms in the developed world. This later spread to other developing countries in the late 1980s. By the 1990s, computers had advanced to the stage where debates could be held about whether it was possible to create spatial architecture in the virtual rather than in the real world (Dare-Abel, Igwe, and Ayo, 2014).

From a few years back, there has been rapid development of CAD in the field of engineering and architecture (World Economic Forum, 2016). CAD systems are used at various stages in the building design process and are integrated with analysis tools (Gero, 2002). It can be used to design 2D floor plans and visualize space within 3D in the field of architecture (Jayathilake and Shantha, 2015). This brought about a gradual end to the manual drafting and tracing era in architectural firms.

Since the 1980s, architectural firms in Nigeria have accepted computer technologies for operations. Since then, there has been incremental growth in the adoption of CAD in the practice of Architecture in Nigeria (Dare Abel, 2013). However, an article by Dare-Abel, Igwe, and Ayo (2014) revealed challenges encountered by architectural firms in adopting CAD. This includes high initial cost of hardware and software, high cost of maintenance, upgrades and training of staff; and health and safety implications. Other challenges are software compatibility problems and system crashes.

As buildings become more complicated due to the introduction of innovative technologies and increased awareness of social and communal needs, the design process requires significant modifications of previous practices to respond to newly emerging requirements (Aksamija & Ali, 2008). It is difficult to imagine how all these would be possible without CAD. CAD helps to bring several factors that affect design and construction, such as environmental sensitivity, energy efficiency, integrated building systems, life safety and security measures. As Aksamija and Ali (2008) observed, these factors might not result in the development of new building types, but instead, they change the nature of architectural discourse and practice and impact the design process. Using Building Information Modeling (BIM) software, architects can now better manage every aspect of a project as a shared database with other professionals whose inputs are needed for efficient job delivery through simulations and collaborations.

Such is the advancement of CAD in architectural practice. It has revolutionised how architects work positively, helping architects make the best design decisions. These gains of CAD in architecture do not appear to be waning as several kinds of research and improvements to existing technologies are underway in various institutions around the globe.

## **COMPUTER AIDED DESIGN IN NIGERIA'S ARCHITECTURE SCHOOL CURRICULUM**

According to MacGregor (2009), education is the fundamental factor in developing human capital, the most influential form of capital, and a central societal development factor. In architectural education, future professional architects' training is based primarily around the design studio, which serves as the pivot and gathering point of all knowledge and skill acquired throughout the curriculum (Mostafa & Mostafa, 2010).

Freehand design, sketching, and manual drafting have always served as useful tools in the crucial stages of ideation and creative development of Architectural design. However, the development of digital technology in architecture has opened up a new vista in the architects' profession and education. As observed by Dare-Abel, Igwe, and Ayo, (2014), a significant revolution in architectural practice occurred on a global scale from the 1980s through 1990s when drawing boards were replaced with the newly developed system called CAD (Computer Aided Drafting). CAD applications are now generally recognized as a vital aspect of computers' utility in the architects' workplace and design industry at large (Suleiman, 2006).

As a result of all these developments, the profession is continuously compelling architecture schools to enhance CAD teaching in their curricula (Pektas & Erkip, 2006). Consequently, Ogunsote, Prucnal-Ogunsote and Umaru, (2006) sought to identify computer courses taught to architecture students in selected universities. The study showed that the Schools of Architecture are making concerted efforts to make CAD an integral part of the training programme. Computer-aided design into the architectural school curriculum has been lengthily debated among scholars (Iwuagwu, Azubuine, & Eme-Anele, 2015). However, it has not yielded the desired fruits as CAD still occupies the background in the architecture schools (Uwakonye, Alagbe, Oluwatayo, Alagbe, & Alalade, 2015). Towards entrenching CAD in the architecture school curriculum, Ogunsote, Prucnal-Ogunsote and Umaru (2006) proposed a CAD curriculum for Nigerian architecture schools cutting across all undergraduate learning levels. They opined that CAD proficiency should cover basic computer literacy, CAD concepts and theory, graphics software, 2D CAD and 3D CAD and visualization.

Notable challenges are affecting the integration of CAD into the architectural curriculum. These include placement of additional work-load on the already overloaded curriculum, lack of sufficiently qualified resource persons, poor power supply and inadequate funding for necessary infrastructure, hardware and software (Iwuagwu, Azubuine, & Eme-Anele, 2015). Added to this is the lack of curriculum specialization by Architectural schools, which has limited the schools in several aspects of their operations, including CAD's successful teaching (Balah & Damen, n. d.). As a result of these bottlenecks, a piecemeal approach has been used to

teach CAD in the curricula of schools of architecture in Nigeria, which is due to the already overloaded curricula. In entrenching CAD training, care must be taken to ensure that students are well-prepared to use the tool by first being adequately trained in manual design and presentation techniques. This will aid the avoidance of 'garbage-in-garbage-out' kind of design endeavour (Al-Qawasmi, 2005; Alagbe, Aderonmu, Opoko, Oluwatayo, & Dare-Abel, 2014).

## **CAD CURRICULUM IN FUTA**

As at the time of conducting this study, an old curriculum is being phased out while a new curriculum takes effect with the 2016/2017 session intake of The Department of Architecture, Federal University of Technology Akure. The old curriculum still applies to the students who participated in this study. In the old curriculum, students could use the computer as a conception tool, while detailed drawings are presented using manual drafting. In the newly revised curriculum of the FUTA architecture school, CAD education was introduced at 300 and 400 undergraduate programs. The CAD courses are compulsory for all architecture students. It is offered in the first semester of the third year as Computer-Aided Design I (ARC 303) and the fourth year as Computer-Aided Design II (ARC 415). It was expected that, at this level of study, students had reached an acceptable design maturity that would enable them to experiment and deal with the advanced design issues explored in the CAD. In ARC 303, students learn computer basics, computer in architecture, operating systems and introduction to hardware and different software. Furthermore, they explore the use of Microsoft office and documentation tools and get an introduction to AutoCAD software. Students are expected to produce 2D drawings of a simple structure using AutoCAD at the end of the semester. In ARC 415, students learn how to use other significant CAD software focusing on their rendering facilities such as Archi-Cad, Revit architecture, Goggle sketch-up and 3D Max (Department of Architecture, FUTA, 2018). However, at the postgraduate level, usually, the initial drafting and modelling are done manually when most design rationalisation occurs, and computer drawing and rendering are mostly used for final presentations and project documentation.

## **STUDENTS' INDUSTRIAL WORK EXPERIENCE SCHEME (SIWES)**

The Students' Industrial Work Experience Scheme (SIWES) is an initiative of the Federal Government of Nigeria. Its implementation is through the Industrial Training Fund (ITF) in collaboration with Universities, Polytechnics and Monotechnics offering science and technology-related courses in Nigeria. It is funded and managed by the national government through the Federal Ministry of Education (Balah & Damen, n. d.). SIWES is fashioned to provide practical opportunities to undergraduates outside of their institutions. The core objective of SIWES is to expose students to industrial practices via attachments to firms and establishments that are engaged in endeavours related to their field of study. Attachments are for a period of up to six months under supervision, after which they are answerable to their respective institutions for assessment. During the internship, the students are expected to have accrued to themselves, tangible work experience, sense of devotion and responsibility, innovativeness, the right attitude to work, and requisite skills. As outlined above, these gains are expected to increase

the students' knowledge in their field of study and fire up their zeal, aspirations, and readiness to be introduced into the work community upon graduation. It also gives the students the opportunity to develop employability skills (Oladimeji et al., 2017)

In the Students' Industrial Work Experience Scheme, architecture students secure attachments to architectural, construction and other related firms and establishments with a view to making them develop more skills in the field of architecture. It exposes them to workplace realities and provides an additional opportunity for students to learn to write field reports.

## METHODOLOGY

A structured questionnaire was used to obtain data. Questions were drawn based on the objectives of the study. Questions that sought to identify students' CAD competency before SIWES, facilitators of CAD training and the CAD competencies required by SIWES employers were included in the questionnaire. Population for the study comprised of fourth-year students of the Department of Architecture, Federal University of Technology Akure, Nigeria (FUTA), who completed the mandatory Students Industrial Work Experience Scheme (SIWES) in the 2015/2016 academic session. Sixty (60) questionnaires were administered, out of which fifty-six (56) were found suitable for analysis. Our study is, therefore, based on the content analysis of fifty-six (56) questionnaires. Descriptive statistics in the form of frequencies and percentages were used to present the responses on the various questions raised. Findings from the study are presented below.

## FINDINGS

Table 1 presents the number of students who had knowledge of CAD before proceeding on SIWES. From the analysis, 96.4% of respondents had acquired knowledge of CAD before going on SIWES. This infers that the level of awareness and readiness to learn CAD is quite high among the students.

**Table 1: Knowledge of CAD before SIWES**

Responses	Frequency	Percentage
Yes	54	96.4
No	2	3.6
Total	56	100.0

Source: Field Work, 2017

With respect to the level or period at which the students began learning the use of CAD, the results showed that the 200 Level was most occurring with 48.2% of respondents, closely followed by the 100 Level with 21.4% (Table 2). Other scenarios that included learning CAD before coming to FUTA; and no prior knowledge of CAD were each represented by 5.4% of respondents. Furthermore, 17.9% of the population indicated 300 Level as their point of learning CAD. However, the higher levels, that is the 400 and 500 Levels, presented 5.4% and 1.8% respectively, an indication that the students' quest for the knowledge of CAD started at the earlier stages of their learning in Architecture.

**Table 2: Level at which respondents begun learning CAD**

Level	Frequency	Percentage
100	12	21.4
200	27	48.2
300	10	17.9
400	3	5.4
500	1	1.8
Others	3	5.4
Total	56	100.0

Source: Field Work, 2017

In response to the enquiry on the level of CAD knowledge acquired before SIWES, most respondents reported that they had acquired the intermediate-level proficiency in CAD with 60.7% occurrence; basic level proficiency was next with 19.6%, closely followed by advanced-level proficiency at 17.9%. Only one person indicated no level of knowledge, which suggests that one of the respondents who had earlier indicated no knowledge of CAD probably had a level of knowledge that may be classified as rudimentary (see Table 1). Therefore, this indicates that the majority (98.2%) of the respondents have at least a basic knowledge of CAD before SIWES (Table 3).

**Table 3: Level of CAD knowledge acquired before SIWES**

Responses	Frequency	Percentage
Basic (2D only)	11	19.6
Intermediate (2D and 3D)	34	60.7
Advanced (2D, 3D, Advanced rendering and animation)	10	17.9
None	1	1.8
Total	56	100.0

Source: Field Work, 2017

With respect to CAD being a part of the curriculum, students' responses showed that 57.1% of respondents believe that CAD training was not included in their Architecture curriculum, while 41.1% opined contrariwise. Contradiction arose from respondents during the survey; CAD was only taught as a small component of 300 and 400 Level design studios and not as a stand-alone course in the curriculum.

**Table 4: CAD training as part of school curriculum**

Responses	Frequency	Percentage
Yes	23	41.1
No	32	57.1
Unsure	01	1.8
Total	56	100.0

Source: Field Work, 2017

Table 5 shows information about the various facilitators of CAD training. Influences of the academic environment are higher at a combined 72.8% occurrence as against private tutors and self-tutoring at an occurrence of 27. 2%.

**Table 5: Facilitators of CAD training**

Facilitators	Frequency	Percentage
Design tutors	5	9.1
Level mates	26	47.3
Senior Architecture students	9	16.4
Private tutors (individual)	5	9.1
Private tutors (training centres)	2	3.6
Self-training	7	12.7
Others	1	1.8
Total	55	100.0

Source: Field Work, 2017

A crucial question which the study sought to answer was if CAD knowledge was a condition for securing the SIWES internship. Table 6 below shows that for 75.0% of the students, CAD knowledge was a condition for securing the SIWES internship. However, CAD knowledge was not a condition for securing the SIWES internship for the remaining 25.0%.

**Table 6: CAD knowledge was condition for securing SIWES internship placement**

Responses	Frequency	Percentage
Yes	42	75.0
No	14	25.0
Total	56	100.0

Source: Field Work, 2017

Furthermore, the study examined the level of CAD knowledge that architectural firms require interns at the entry point. The survey showed that 21.4% required Basic CAD knowledge (2D only); 50.0% required Intermediate knowledge (2D and 3D) while for 21.4% of students, Advanced CAD knowledge (2D, 3D, rendering and animation) was required at the point of seeking SIWES placement.

**Table 7: Level of CAD knowledge which the employer required at the point of seeking SIWES placement**

Responses	Frequency	Percentage
Basic (2D only)	12	21.4
Intermediate (2D and 3D)	28	50.0
Advanced (2D, 3D, Advanced rendering and animation)	12	21.4
None	4	7.2
Total	56	100.0

Source: Field Work, 2017

In Table 8 below, a list of CAD software is presented, and the number of proficient respondents before IT is given. Note that a student may be proficient in more than one software; hence, the total figures may not add up to each category's sample size.

**Table 8: CAD software in which respondents were proficient before SIWES**

Software	Frequency
Autodesk AutoCAD	46
Graphisoft ArchiCAD	26
Autodesk Revit Architecture	36
Google SketchUp	9
Artlantis Studio	15
Rhinoceros	2
Autodesk 3D Max	6
Lumion	6
Others	14

Source: Field Work, 2017

**Table 9: Additional CAD training by SIWES establishment to help fit into the workplace**

Responses	Frequency	Percentage
Yes	25	44.64
No	31	55.36
Total	56	100.0

Source: Field Work, 2017

From Table 9, the study sought to know whether or not architectural establishments have CAD training programmes for their new interns. A little over half (55.36%) of the establishments do not have additional CAD training to help their employees fit into the workplace.

Table 10 reveals the types of software training on offer to interns who got additional training at the entry point. Almost half (48.0%) of the architectural establishments gave Autodesk AutoCAD training to interns, while 28.0% gave Autodesk Revit Architecture training. Furthermore, 12.0% of the architectural establishments gave Graphisoft ArchiCAD training, while 8.0% gave Autodesk 3D Max training. Rhinoceros software was the least on offer at 4.0%.

**Table 10: Type of CAD software training that was received by students during SIWES internship**

Responses	Frequency	Percentage
Autodesk AutoCAD	12	48.0
Graphisoft ArchiCAD	3	12.0
Autodesk Revit Architecture	7	28.0
Rhinoceros	1	4.0
Autodesk 3D Max	2	8.0
Total	25	100.0

Source: Field Work, 2017

Finally, Table 11 shows that occurrence of acquisition of higher CAD knowledge after SIWES was in the majority (66.1%), while 25.0% did not acquire a higher level of CAD competency after SIWES.



**Table 11: Acquisition of higher CAD knowledge at the completion of SIWES**

Responses	Frequency	Percentage
Yes	37	66.1
No	14	25.0
Uncertain	5	8.9
Total	56	100.0

Source: Field Work, 2017

### **Implications of findings for academia and architectural practice**

The findings shows that less than 10% of the sample gained CAD competency through the design tutors. Nonetheless, 88.6% of the students have knowledge of CAD which is good enough to enter most architecture firms (intermediate knowledge, 60.7%; advanced knowledge, 17.9%). However, employers require definite CAD competencies ranging from basic to advanced CAD competencies from over 90% of prospective SIWES interns. Most students acquired CAD knowledge from level mates and senior architecture students (47.3% & 16.4% respectively). The findings therefore implies the inadequacy of formal CAD pedagogy as offered through teaching staff to prospective SIWES interns. The need to overhaul CAD curriculum and pedagogy is further highlighted. The availability or otherwise of sufficient CAD savvy Tutors needs to be scrutinized. In the short term, it is likely that students will continue to rely on non-formal means of acquiring CAD competency to bridge the gap. Architectural practice will definitely seek more advanced CAD competencies from interns and staff while the architecture schools play catch up.

## **CHALLENGES FOR ARCHITECTURAL EDUCATION**

Massive transformations in architecture and construction, aided by technological advancements in CAD and ICT, have made architectural education devoid of computing skills near obsolete. Over the past four decades, the steady and rapid growth of CAD applications to the field of architecture has been relentless. The emergence of 3-D printing, for example, holds enormous potential for revolutionising construction (World Economic Forum, 2016). Because recent advancements like 3-D printing rely on cutting-edge CAD and ICT to function, it becomes germane that the training of architects must consider contemporary advancements in CAD.

A combination of excellent traditional sketching and design skills with CAD proficiency is key to survival in the highly competitive architecture field. This is where the architecture school must excel. The School curriculum has to be responsive and even pro-active to accommodate the challenges that CAD realities have brought upon the architectural profession. How well this has been done in Nigeria is always in question and will remain so until a significant shake-up is made in the school curriculum. The dynamism that CAD has brought to architecture poses specific challenges that the architectural schools must respond to, being the training ground for future architects who are expected to shape society's physical fabric. In all these, the expectations of architectural establishments for the architectural graduate most be borne in mind. This is to ensure that whatever the processes adopted to combat the challenges of students' CAD proficiency; it must

be relevant to the work environment in which they are expected to function on completion of their studies.

Some challenges that are inhibiting the training of CAD proficient architects were identified first from the literature and second, from our survey and are highlighted and discussed below:

- 1. A near static curriculum in an era of rapid technological change:** The architecture school curriculum in Nigeria has come under intense scrutiny over the last three decades (Olotuah, 2005; Uwakonye, Alagbe, Oluwatayo, Alagbe, & Alalade, 2015). One of its main shortcomings is CAD's poor presentation, making it seem almost absent (Ogunsote, Prucnal-Ogunsote, & Umaru, 2006; Uwakonye, Alagbe, Oluwatayo, Alagbe, & Alalade, 2015). Since the curriculum is the guide for the teaching of architecture, what the student learns is determined mainly by the curriculum's design and implementation. A curriculum that does not give due attention to CAD will result in students being trained in an environment that inhibits their growth in CAD applications. Furthermore, this is a significant challenge to the training of CAD competent architects in Nigeria. The continuous relevance of drawing board-based studios in this computer age is still unclear. The earlier the architectural educators and proprietors face the computer revolution reality, the better for architectural education and practice. The rate at which technology advances over the last few decades poses a critical challenge to architectural education and CAD competent students' training. The rate at which software is being developed and replaced is quite challenging. These changes leave architectural educators and architects almost no time to react, with new developments springing up every few months (Bobadoye, 2002). Computer technology is an indispensable tool for the accumulation and distribution of knowledge in today's information-driven world. Hence, architectural education must be flexible and dynamic enough to cope with rapid technological changes. Nevertheless, Field (2005) warns on the limitations of computer technology to both the practice and education of architecture if architecture is more than a direct problem-solving profession.
- 2. Funding:** The availability and process of providing funds is a cardinal challenge to the training of CAD competent students. This challenge plays out in several ways. The first problem is that government, which is the main sponsor of architectural education in Nigeria, has demonstrated its inability to solely and adequately fund architecture schools. The problem is now made worse by the downturn in Nigeria's economy and the associated dwindling allocations to the education sector. The second problem is acquiring the full licensed software packages that are needed for academic instruction in the architectural school and utilising the funds efficiently to get the best deals. CAD software is expensive, and upgrades do not come cheap either. In addition to the cost of acquiring licensed CAD software, schools are required to set-up standard fully equipped CAD laboratories where CAD teaching can be comfortably done to the full benefit of students. Another way funding becomes a challenge is when we consider that students who use the self-help route to gain CAD competency usually pay significant amounts of money to acquire the training. Not every architecture student can bear the cost. Insufficient funding of architectural education poses a definite challenge to effective CAD pedagogy.

- 3. The paucity of CAD specialists among teaching staff:** This critical challenge to the production of CAD competent architecture graduates focuses on the teaching staff in schools of architecture in Nigeria. Here, the challenge arises from the fact that compared to industry standards, most teaching staff possess little or near obsolete CAD skills and rarely have core specialisation in CAD. The shortcomings have rendered most teaching staff in architecture schools incompetent to handle the teaching of CAD to their current crop of students. The magnitude of this single challenge is quite enormous; it is at the core of the challenge of producing CAD proficient students. Without capable teaching staff, modifications to the curriculum and provision of more funds will be meaningless, and the expected result, which is the production of CAD competent graduates, will not be achieved.

### Suggestions

The challenges associated with producing CAD competent students can be tackled reasonably if the following suggestions are implemented:

- **Designing a CAD curriculum minimum benchmark for architecture students:** This study suggests collaborations among Nigerian schools of architecture, Association of Architectural Educators (AARCHES), Architects Registration Council of Nigeria (ARCON) and Nigerian Universities Commission (NUC) to establish a 21st Century relevant national CAD curriculum benchmark for architecture students. In the interim, we suggest that CAD courses should be mounted in the third and fourth of year of undergraduate studies in architecture with additional courses at the Master's degree programmes. These study levels are suggested since students need to acquire basic knowledge in the design and related subjects upon which CAD pedagogy can be built.
- **Establishment and proper funding of CAD laboratories:** standard and functional CAD laboratories should be established in each architecture school. We suggest the sequential acquisition of computer hardware, software, and ancillary equipment to respond to funding limitations. In line with the foregoing, public-private partnership is advocated to assist the architecture schools with establishing truly functional CAD laboratories in light of the government's inability to bear the enterprise's financial burden alone. The enthralling global village that ICT has turned the world into makes it imperative for architectural firms to collaborate with the academic institutions to achieve desired results.
- **Re-skilling and up-skilling of architectural educators:** Architect educators should be supported to attain cutting edge competency in CAD (2D, 3D rendering, visualization and animation) and Building Information Modeling (BIM). Scholarships and grants will significantly help educators pursue a specialization in the challenging but exciting world of architectural computing. Reskilling and up-skilling of architect educators are critical to kick-starting a CAD pedagogy revolution. Educators must engage in continuous learning and should know enough to train industry-relevant graduates. This is in line with the global best practice where educators and students are encouraged to engage in lifetime training (World Economic Forum, 2016) This, in synergy with traditional training and design experience of lecturers, will go a long way in facilitating the effective teaching and learning of CAD in the schools. Regular collaborations that feature workshops on computer application in architecture

should be undertaken by stakeholders such as the Nigerian Institute of Architects (NIA) and Association of Architectural Educators in Nigeria (AARCHES) as forms of continuing education for practicing architects and architect-educators. This will also serve to bring educators and practitioners up to date with the latest CAD developments in architecture and construction.

## CONCLUSIONS

The use of computing in architecture in Nigeria has only been on for about four decades. However, it has recorded phenomenal growth over the period. The deployment of CAD in architectural practice has increased tremendously in twenty-first century Nigeria. We hypothesize that all leading architectural firms have become computerized. It is rare for a non-computerized architectural practice to win decent commissions. It is also unlikely that a graduate of architecture will get an excellent job in an architecture firm without being CAD competent (Lawani, 2001; Bobadoye, 2002).

Advancements in Computer Technology and its robust application to architectural practice pose a definite challenge to architectural education, and the response has been painfully slow. Restructuring of the architecture curriculum, establishment and proper funding of CAD laboratories in schools of architecture, sequential acquisition of computers and associated equipment by the schools, public-private sector partnership, re-skilling and up-skilling of architectural educators are suggested as means of equipping students of architectural schools Nigeria to meet the challenges of the dynamic nature of the global architectural practice. Further research may consider how students' dominant reliance on self-help as means to gain CAD competence impact on their understanding of basic architectural principles.

## REFERENCES

- Abubakar, S. (2006) 'Evolution of the Computer as a tool of design in architecture', *AARCHES Journal*, 5(2).
- Akin, O., & Anadol, Z. (1993) 'What's wrong with CAD?', 4th International Symposium on Systems Research, Informatics and Cybernetics, Baden-Baden, Germany.
- Aksamija, A., & Ali, M. (2008) 'Information technology and architectural practice: knowledge modeling approach and BIM', *Proceedings of AIA IL Conference: Breaking New Ground*, Moline, IL.
- Alagbe, O., Aderonmu, P., Opoko, A., Oluwatayo, A., & Dare-Abel, O. (2014) 'Relevance of manual drafting in design studio education in Nigeria: Covenant University Architecture Students Perspective', *Proceedings of EDULEARN14 Conference*. Barcelona, Spain.
- Al-Qawasmī, J. (2005) 'Digital media in architectural design education: reflections on the e-studio pedagogy', *Journal of Art, Design & Communication in Higher Education*, 4(3).
- Andia, A. (2001) 'Integrating digital design and architecture during the past three decades', *Proceedings of the Seventh International Conference on Virtual Systems and Multimedia*.

- Balah, M., & Damen, M. R. (n. d.) 'Strategic curriculum for effective performance of graduate architects: The use of CAD as SIWES component', p1-11.
- Bobadoye, S. A. (2002) 'Emerging trends in computer applications to architecture in Nigeria', *AARCHES Journal*, 2(1), p26–32.
- Bobadoye, S. A. (2004) 'Towards the integration of computer aided design and draughting into the mainstream of architectural education', *International Journal of Environmental Science*, 1(1&2), p71-81.
- Dare-Abel, O. A. (2013) 'Information and communication technology (ICT) deployment in architectural firms in Nigeria', Ph.D dissertation, Covenant University, Department of Architecture, Ota.
- Dare-Abel, O. A., Alagbe, O. A., Aderonmu, P. A., Ekhaese, O. N., & Adewale, B. A. (2015) 'Pathways to Architectural Education and Practice Success in Nigeria. *Journal of Education and Practice*', 6(4).
- Dare-Abel, O., Igwe, J., & Ayo, C. (2014) 'Proficiency and Capacity Building of Human Capital in Architectural Firms in Nigeria', *International Journal of Architecture and Design*, 25(2), p1133-1139.
- Department of Architecture. (2018). Department of Architecture, FUTA. Available at: <https://www.arc.futa.edu.ng/home/1665> (Accessed: December 12, 2018).
- EAAE Prize. (2005) 'Transaction on architectural education', in Ebbe, H. (ed.) *Writings in Architectural Education*. 26.
- Fjeld, P. O. (2005) 'Teaching Architecture - A revitalization of architectural consciousness. in Ebbe, H. (ed.) *Writing in Architectural Education*.
- Gero, J. S. (1983) 'Computer-aided architectural design – past, present and future' *Architectural Science Review*, 26, p2–5.
- Gero, J. S. (2002) 'Advances in IT for building design', In M. Anson, J. Ko, & E. Lam (Eds.), *Advances in Building Technology*, p47-54. Amsterdam: Elsevier.
- Gigante, M. A. (1993) 'Virtual reality: Enabling technologies', In Eamshaw, R. A., Gigante, M. A. & Jones, H. (eds.), *Virtual reality systems*, p15-25. London: Academic Press.
- Glancey, J. (2000) 'The story of architecture', London: Dorling Kindersley Limited.
- Hendrickson, C., & Au, T. (1985) 'Project management for construction', N. J.: Prentice Hall.
- Iwuagwu, B. U., Azubuine, C. E., & Eme-Anele, N. (2015) 'The hopes and challenges of using computers as alternative to drawing boards for the training of architecture students in Nigeria', *Journal of Educational Policy and Entrepreneurial Research (JEPER)*, 2(9), p206-212.
- Jackson, M. J. (1986) 'Computer in construction planning and control', London: Allen Unwin.
- Jayathilake, M. V., & Shantha, P. H. (2015) 'Comparative study of CAD software use for architectural designs', *International Research Symposium on Engineering Advancements*. Malabe, Sri Lanka.
- Lalit, N., & Lalit, K. (2008). *Computer aided design and manufacturing*. New Delhi: Prentice Hall of India.
- Lawani, O. (2001). *Students industrial work experience scheme report*. Akure: Department of Architecture, Federal University of Technology, Akure.
- MacGregor, K. (2009). *GLOBAL: Higher education in the future*. Retrieved from <http://www.universityworldnews.com/article.php>

- Moore, W. C. (ed.) (1984). *Small computer in construction*. New York: HSCE.
- Mostafa, M., & Mostafa, H. (2010). How do architects think? Learning styles and architectural education. *Archnet-IJAR*, 4(2/3), 310-317.
- Novak, M. (1998) 'Next babylon, soft babylon', *Architectural Design*, Special edition of architecture in cyberspace.
- Ogunsote, O. O. (2001) 'Three dimensional modeling in AutoCAD 2000: production of drawings using multiple layers and layouts in paper space', *AARCHESJ*, 1(6), p82-86.
- Ogunsote, O. O., Prucnal-Ogunsote, B., & Umaru, N. A. (2006) 'Curricular anatomy of the CAD proficient architecture graduate in Nigeria' *Association of Architectural Educators in Nigeria*.
- Ogunsote, O., & Prucnal-Ogunsote, B. (1987) 'Computing in Architectural education in Nigeria. The ABU experience', *NIA Journal*, p12-15.
- Olotuah, A. O. (2005) 'Appraisal of architectural education in Nigeria', *CEBE Transactions*.
- Oluwatayo, A. (2009). A critical study of the practice characteristics of architectural firms in Nigeria. Unpublished PhD dissertation, Covenant university, Otta.
- Pektas, S. T., & Erkip, F. (2006) 'Attitudes of design students toward computer usage in design', *International Journal of Technology and Design Education*, 16, p79-95.
- Rabee, R. M. (2006) 'Computing in architectural design: reflections and an approach to new generations of computers', Retrieved from <http://www.itcon.org/2006/45/>
- Sa'ad, H. T. (2001) 'The changing role of the architect and architecture in the context of the ever-changing technological, socio-economic and political global environment', in Nkwogu, U. (ed.) *Architects and architecture in Nigeria*. Association of Architectural Educators in Nigeria (AARCHES), p1 -16.
- Suleiman, I. (2006) 'Computer aided drafting and design: professional applications and the university curriculum', *AARCHES Journal*, 5(1), p18-26.
- Tasl, S. (2001). Bridging the gap between theory and practice in architectural education: the case of CAAD teaching. *Proceedings of the 19th EAAE International Conference, Re-integrating Theory and Design in Architectural Education*.
- Thomas, M. (2005). *Informed architecture: three tension*, in Ebbe, H. (ed.) *Writing in Architectural Education*.
- Udeh, C. A. (1995) 'Computer education: preparing the architects for the challenges of the new information age', *Emerging dimensions in Nigerian architecture*. Bauchi: AARCHES AGM Seminar.
- Uwakonye, O., Alagbe, O., Oluwatayo, A., Alagbe, T., & Alalade, G. (2015) 'Developing a new framework for integration and teaching of computer aided architectural design (caad) in nigerian schools of architecture', *Journal of Education and Practice*, 6(3), p17.
- World Economic Forum. (2016) *The future of jobs: employment, skills and workforce strategies for the fourth industrial revolution*. Geneva: World Economic Forum.



---

# AN EXPLORATION OF SPATIAL LAYOUT AND COMMUNICATION PATTERNS IN TERTIARY HOSPITAL DESIGN: AN INNOVATIVE APPROACH TO SUSTAINABLE HOSPITAL DESIGN

Ejeh David Ekoja<sup>1</sup>, Sagada Musa Lawal<sup>2</sup>, Oluigbo Stephen Nwabunwanne<sup>3</sup>, Maina Joy Joshua<sup>4</sup> and Sufiyan Mu'awiyah Babale<sup>5</sup>

<sup>1,2,3,4</sup>Architecture, Ahmadu Bello University, Nigeria

<sup>5</sup>Community Medicine, Ahmadu Bello University, Nigeria

Hospitals are designed to provide healthcare. This is the goal of any healthcare institution. From previous studies, 36% of the mortality rates in Tertiary Hospitals in Nigeria have been attributed to communication errors between and among healthcare professionals and patients. While it is obvious that there is a complex communication pattern in the Hospital environment, this study sought to investigate how the spatial layout is related to how the users of the hospital's spatial layout communicate. Thus, this study sought to probe specific ways the spatial layout is related to communication patterns in the Hospital environment. To achieve this, this study developed a conceptual framework that interpreted the spatial layouts in Hospitals based on the Space Syntax theory and communication patterns on the concept of organisational culture and social interactions. Based on the framework, a sequential transformative research design was used to guide the gathering, analysis and interpretation of data. Using DepthmapX and hospital design sketches, this study assessed the spatial characteristics of hospital design based on three spatial Depth and Shape of the Spatial layout. Closed Circuit Televisions (CCTVs) were used to monitor users' social networks in these spatial categories. In a bid to explore the relationship between spatial layout and communication patterns in Tertiary Hospital design, results revealed, among other findings, that the shape, size, and depth, of the Spatial layout contribute significantly to the predominant communication pattern in the Treatment and Diagnostics Areas (Vertical Communication patterns). This study concludes through an Evidenced-based Design framework that the spatial layout of the hospital is strongly related and influences the patterns of communication among healthcare professionals and between healthcare professionals and patients. It is, however, recommended that further comparative studies be conducted to validate findings in this study, as this study (a case study) was conducted to develop theory in this regard.

Keywords: communication patterns, organisational culture, social interactions, space syntax, spatial layout

---

<sup>1</sup>archejeh@gmail.com

<sup>2</sup>msagada@yahoo.com

<sup>3</sup>stephenoluigbo@gmail.com

<sup>4</sup>joyamina16@gmail.com

<sup>5</sup>sufiyanmb@gmail.com

## INTRODUCTION

Hospitals are designed to provide medical services to patients. The design of hospital spaces promotes easy accessibility, easy movement and easy communication between health workers and health workers and patients. (Wagenaar and Men, 2018) From an architecture point of view, the design of a hospital can either enhance or limit the level of communication between health workers and between health workers and patients. When communication is impeded or distorted due to the design, it could lead to poor healthcare service delivery, leading to increased mortality (Ogunola, 2015, Tahir, Haming and Bijaang, 2018). Barasa, Molyneux, English, and Cleary (2017) noted that communication in a hospital environment is complex because of the different categories of professionals, creating communication problems (Sari 2017; Scott, 2017).

The concept of communication, not just in hospitals, is not new and is normally related to the effective service delivery of various organisations (Scott, 2017). How an organisation delivers its services to some degree is affected by how the organisation communicates (methods and patterns). For example, healthcare delivery in hospitals, which is regarded as an organisation, depends on the way and manner of communication. Tahir, Haming and Bijaang (2018) point out that an organisation's communication is a critical factor in achieving set organisational goals and objectives, coordinating material and human elements of the organisation. In other words, all the components that contribute to its service delivery (Lee, 2003, Mckinney, Barker, Smith & Davis, 2004; Scott, 2004;). Consequently, Ogunola (2015), in a study, established that there is a significant relationship between the patterns of communication and the delivery of health care services in Hospitals.

In this relationship stated above, the design of hospitals plays a major role (Rees and Smith, 2017). Furthermore, according to Wagenaar and Mens (2018), the design of hospitals has been strongly linked to the development of service delivery. In other words, the development of the design of hospitals is strongly related to the development of its service delivery.

To put this in proper perspective, a recent survey of a handful of National teaching hospitals including the Ahmadu Bello University Teaching Hospital by Oladejo, Umeh, & Ogbuefi, (2015) revealed that 36% of the errors committed in the delivery of Healthcare services were traced to poor communication between the various players in the Hospital environment. This has resulted in poor service delivery, which accounts for over 20% of the mortality rate recorded in the hospital (Okonofua, Ntoimo, Ogu, Galadanci, Abdus-Salam, Gana, & Randawa, 2018, Jamoh, Abubakar and Isa, 2018).

Technology has played a vital in communications in the hospital environment (Martin, et al., 2019). However, scholars in the medical practice still believe that interpersonal communication is vital in healthcare delivery and forms the basis for mentorship and tutelage in the medical professional. (Ezeah, et al., 2020, Chichirez & Purcărea, 2018, Pirnejad, et al, 2008, de Negri, et al 1997, Thompsonv& Parrott, 1994).



Most of the studies have focused on the relationship between hospital design and the effective delivery of care. (Sailer & Penn, 2007. Sailer, et al., 2009, Sailer, et al., 2013). The findings in these studies highlighted how healthcare environments affect staff health and safety and how the design of hospitals can improve staff effectiveness and satisfaction. Other studies have focused on how the design of hospitals can improve the safety and outcome of the patient. Pachilova & Sailer, 2014, Pachilova, & Sailer, 2015). These studies have linked the design of the physical environment to patient falls and medication errors, infection, patient confidentiality and privacy and highlighted the strong impact of the hospital's design on different aspects of patient safety. Other researchers have focused on the impact of the physical environment on Stress, depression and the effectiveness of organisational patterns, especially among staff and patient. (Alfonsi, Capolongo & Buffoli, 2014).

## PROBLEM FOCUS

Most studies in spatial layout and communication in hospitals have focused more on how hospital designs affect the communication of single groups (example nurses) and groups of two (nurses and patients) while neglecting the complex social network (communication patterns) between different user groups in the hospital Pachilova, & Sailer, 2015). environment. Though these studies have been able to address some of the social problems like commitment, satisfaction and even communications in the Hospital design, the solutions suggested have been about these selected groups which are not representative of the entire communications that are needed for effective service delivery in hospitals. In other words, communication involving the entire players in the Hospital environment is what determines effective healthcare delivery. As a result, studies done in this area has said little in specifically itemising the extent to which the hospital's design influences the communication patterns (involving all players) in the delivery of healthcare services. (Sailer & Penn, 2007. Sailer, et al., 2009, Sailer, et al., 2013)

Furthermore, communication patterns occur within the hospital's design space and it is assumed that it would influence the outcome and pattern of communications. On paper, the use of the designed spaces of Hospitals by the users in the Hospital environment is governed by its structure and this is usually termed as strongly programmed, where the communication patterns between its users follow the rules and requirements of the organisation, in this case, Hospitals Sailer, Pachilova, Kostopoulou, Pradinuk, Mackinnor and Hoofwifjk (2013),. In reality, the interplay of these different roles according to research record overlapping responsibilities which affect the use of the hospital's design space and subsequently the communication patterns which influence healthcare delivery. Put differently, most of the studies in this area have focused on the organisational structure which defines how communication should be with a lesser focus on how communication is carried out in the design spaces of the Hospital environment. Thus, spatially related design solutions to communication-related problems in hospitals have not focused more on empirical data, which can provide a unique approach to adequately address a range of the communication problems in the Hospital environment. This is against a backdrop of a popular comparative research type in hospitals that favour generalisations with a lesser focus for example on the uniqueness of communication patterns in hospitals.

Subsequently, Sailer, Pachilova, Kostopoulou, Pradinuk, Mackinnor and Hoofwifjk (2013), observed the communication patterns (social interactions) of three categories of users (physicians, nurses and clerks) and correlated with the spatial layout of two different hospital design. Though the study investigated the relationship between spatial layout and communication patterns, the patient, who sits at the focal point of Hospital Design (Wagenaar & Mens, 2019) and a major stakeholder in the patterns of communication (social interaction) in hospitals has seldom be catered for in spatial layout-communication research in Architecture. This has translated to evidence-based design frameworks that are tailored towards specific groups in the Hospital environment. and do not effectively address the communication problems associated with the complex social interaction involving the entire groups representative in the Hospital environment.

Similarly, Cai, and Zimring's study (2019), sought to understand the relationship between spatial layout and communication across two distinct cultural regions (China and USA). This was a comparative study of Hospital designs in the United States of America and the Republic of China. It focused very little on establishing and building a theory between the communication patterns in Hospitals, interpreted in this study as the social interactions between the players in the Hospital environment including patients and the spatial layout of the Hospitals where these social interactions occur. Subsequently, the findings in the study addressed hypothetically the relationship between the spatial layout of Hospitals and the Culture in the two distinct cultures investigated (the United States and China). The issue is that, like many other studies in this area. There is little knowledge about the communications patterns prevalent in the Hospital environment, especially when considering all players in the organisation. Also, there seems to be little evidence-based design information on the specific ways the spatial layout of Hospitals influences communication patterns, which is unique to different hospital environments. Thus, this paper aimed to investigate the impact of spatial layout on organisational communication patterns in tertiary hospital design and propose an evidence-based design (EBD) in hospital architecture. To achieve this, the following objectives were listed

1. To interpret the concepts of spatial layouts and communication patterns in Tertiary Hospitals.
2. To explore the prevailing communication patterns and characteristics of spatial layout in Tertiary hospital design.
3. To propose an evidence-based design framework highlighting the relationship between spatial layout and communication patterns in the hospital environment.

## **LITERATURE REVIEW**

This paper operationalised spatial configuration and communication patterns to explore the relationship between space and communication patterns.

The concept of space syntax was used to interpret the concept of spatial configuration. Hillier and Hanson (1984) opined that the spatial configuration of different building typologies have unique social millieux. The social milieu is a combination of the spatial configuration's structure, function and aesthetics.

**Table 1.1: A list of studies on organisational communication and spatial configuration**

No	Author/ Year	Study
1	Cai H, Zimring C.(2017).	Cultural impacts on nursing unit design: A comparative study on Chinese nursing unit typologies and their U.S. counterparts using space syntax
2	Real, K., Bardach, S. H., & Bardach, D. R. (2017)	The role of the built environment: how decentralised nurse stations shape communication, patient care processes, and patient outcomes.
3	Gharaveis, A., Hamilton, D. K., & Pati, D. (2017)	The Impact of Environmental Design on Teamwork and Communication in Healthcare Facilities: A Systematic Literature Review.
4	Rippin, A. S., Zimring, C., Samuels, O., & Denham, M. E. (2015)	Finding a Middle Ground: Exploring the Impact of Patient-and Family-Centered Design on Nurse–Family Interactions in the Neuro ICU
5	Rashid, M. (2015).	Research on nursing unit layouts: an integrative review.
6	Hua, Becker, Wurmser, Bliss, Haltz and Hedges (2015).	Effects of nursing unit spatial layout on nursing team communication patterns, quality of care, and patient safety
7	Liu, Mainas and Gerdtz (2014)	The effects of physical environments in medical wards on medication communication processes affecting patient safety
8	Bayramzadeh, S., & Alkazemi, M. F. (2014).	Centralised vs. decentralised nursing stations: An evaluation of the implications of communication technologies in healthcare.
9	Pachilova, R., & Sailer, K. (2013)	The Effect of Hospital Layout on Caregiver-Patient Communication Patterns
10	Cai, H., & Zimring, C. (2012)	Out of Sight, Out of Reach: Correlating spatial metrics of nurse station typology with nurses' communication and co-awareness in an intensive care unit
11	Rashid, 2009	Space, behaviour, and environmental perception in open-plan offices: a prospective study
12	Sailer et al., 2009	Comparative studies of offices pre and post—how changing spatial configurations affect organisational behaviours
13	Sailer & Penn, 2009	Spatiality and transpatiality in workplace environments
14	Wineman et al., 2009	Spatial and Social Networks in Organizational Innovation
15	Penn et al., 2007	Structure, Agency, and Space in the Emergence of Organizational Culture
16	Peponis et al., 2007	Designing space to support knowledge work
17	Sailer, 2007	Movement in workplace environments—configurational or programmed?
18	Sailer et al., 2007	Effective workplaces: bridging the gap between architectural research and design practice
19	Sailer & Penn, 2007	The performance of space—exploring social and spatial phenomena of interaction patterns in an organisation
20	Wineman & Adhya, 2007	Enhancing Workspace Performance: Predicting the Influence of Spatial and Psychosocial Factors on Job Satisfaction
21	Rashid et al., 2006	Spatial layout and face-to-face interaction in offices--a study of the mechanisms of spatial effects on face-to-face interaction
22	Hanson & Zako, 2005	Configuration and Design in Caring Environments: Syntax and quality of life in a sample of residential care homes for older people
22	Rashid et al., 2005	The Effects of Spatial Behaviors and Layout Attributes on Individuals' Perception of Psychosocial Constructs in Offices
23	Rashid & Zimring, 2003	Organisational constructs and the structure of space: A comparative study of office layouts
24	Penn et al., 1999	The Space of Innovation: Interaction and Communication in the Work Environment
25	Serrato & Wineman, 1999	Spatial and Communication Patterns in Research and Development Facilities
26	Peatross, 1997	The Spatial Dimension of Control in Restrictive Settings
27	Wineman & Serrato, 1997	Enhancing Communication in Lab-based Organizations
28	Peatross & Peponis, 1995	Space, Education, and Socialization
29	Penn & Hillier, 1992	The social potential of buildings: spatial structure and the innovative milieu in scientific research laboratories
30	Allen, 1977	Managing the Flow of Technology

In other words, a spatially configured space can evoke unique experiences that are a combination of its primary function, the way individual spaces that make up the spatial layout are arranged (structure) and the architectural symbols used in the spatial configuration.

Furthermore, the concept of space syntax provides numerical interpretation through spatial metrics that help to characterise any space in terms of its size, shape, depth, global properties, the potential to explore and move, and complexities (Koutsolampros et al. 2019).

On the other hand, the concept of communication patterns was interpreted with Hofstede (2015) concept of organisational culture. Previous communication-related studies understood communication strictly through the lens of organisational structure, highlighting how communication patterns should be in the hospital environment. However, this research posts a dynamic nature to the communication patterns in the hospital environment. This can be interpreted through the concept of its organisational culture, which reveals the communication patterns in reality. This study went further to use the Hofstede (2015) concept of organisational culture to interpret communication patterns as social interactions within the hospital environment. This paper posits that interactions among the different user groups still form the core of health care delivery and tutelage. Thus the [a]er acknowledges the use of technology to aid and not replace physical interactions within the hospital environment. Thus, this study focuses on the attributes, behaviours and values which reveal prevailing communication patterns within the hospital environment.

After contextualising the concepts under consideration, the paper proceeded to online databases to search for relevant published literature in line with the purpose of this paper. The selection of the databases was based on proven records of research in human behaviour in the built environment. Three databases were used, namely, SAGE journals, Medline and Google scholar. Keywords used in the search for related articles included spatial configuration, communication, behaviour, and healthcare settings. After a preliminary review of the paper titles, 101 related articles were listed as research done in human behaviour in healthcare settings. A thorough review of the Abstract and major findings highlighted 30 studies that have targeted the investigation of organisational communication and spatial configuration in healthcare environments. These studies outlined in table 1.1 show the title and year of the research.

To analyse the data in the literature reviewed a summative content analysis was used. This was done to understand the conceptual use of the concepts under review, examine language intensely in order to classify texts in categories and most importantly interpret the context of text data through systematic classification.

The criteria used to examine the content were based on;

- i. The aim and the findings of the study
- ii. The objectives and methodology of the study

**Findings from the review based on these two criteria included;**

1. Most studies were focused on how the spatial configurations of complex building typologies affected the communication patterns of single groups (example, nurses) and groups of two (example, nurses and physicians)
2. Also, most studies failed to incorporate the patient group in the study of the complex social network within the hospital environment, which according to literature, is pivotal in the design of hospitals and a key node in communication relations in healthcare environments.
3. Recent research was not based on empirical data (observed communication pattern) and focused on theoretical assumptions.
4. Regarding the findings, most studies were limited to comparisons of different cultures and building typologies. Thus most studies highlighted differences and similarities between the different hospital typologies among different cultures and failed to study in-depth.
5. Methods used to assess space were based on the theory of space syntax. Thus studies under review highlighted key spatial measures used in assessing the spatial configuration of healthcare environments. Examples of these measures include Accessibility, Copresence, Integration (Global and Local), connectivity, length of axial lines and visibility.
6. Organisational measures used to assess communication were movement, behaviour during communication, tie strength, face-to-face interaction, territoriality, frequency of interaction, location of interaction.
7. Most studies recorded the use of statistical analysis in harmonising spatial analysis data and data from communication patterns—for example, Pearsons' Correlation and Multiple linear regression to highlight relationships between the two concepts.

## **THEORETICAL FRAMEWORK**

In developing the theoretical framework for the study, the research understood the organisational communication in Hospitals to depict the social interactions between the key players (Doctors, Nurses, Medical Personnel and Patient) within the hospital environment. According to Sadia, Salleh, Kadir and Sanif (2016), there is a relationship between organisational culture, organisational structure, and communication patterns in a hospital environment. It must be pointed out that communication patterns do not refer to communication in hospitals as elucidated in the Organisational structure of Hospitals. Put differently, an organisational structure provides on paper how communication in hospitals should be. However, the Organisational culture presents communication as it is in the hospital and thus provides a valid interpretation of the communication patterns in the hospital.

The organisational culture is expressed through the attitudes, behaviour and values in the hospital organisation. Therefore, it portrays the patterns of communication that is of interest in this study to a certain degree. These patterns of communications that the Behavioural and Movement patterns can observe can be

measured by analysing the structure of social networks. The structure of social networks can be measured by the Number of Ties, Average Degree and Betweenness Centrality. These variables of the social networks within the hospital environment define the patterns of communication. These variables and measures can be related to the properties of space, defined by the concept of space syntax and measured using spatial metrics that measure the Size, Shape and Normalised Depth of the spatial layout (Koutsolampros, 2019).

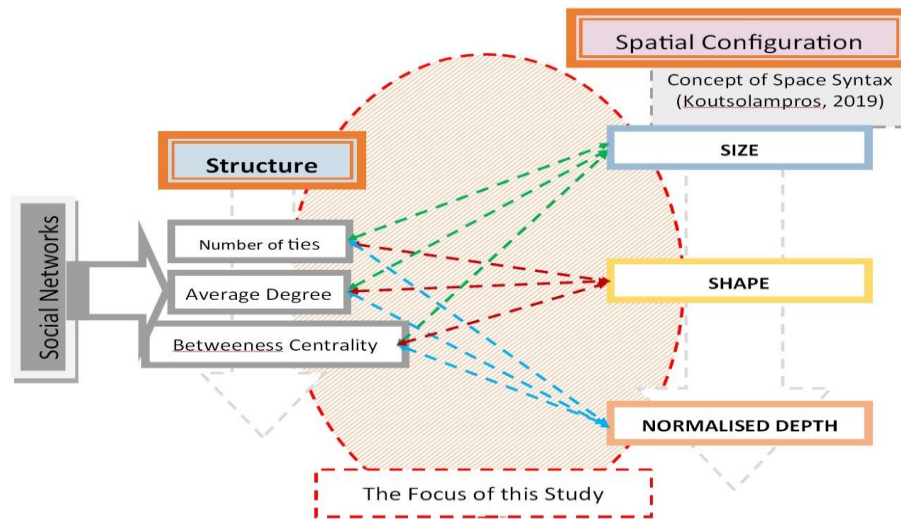

Figure 1: Relationship between the constructs of Communication and Spatial layout in Hospital design

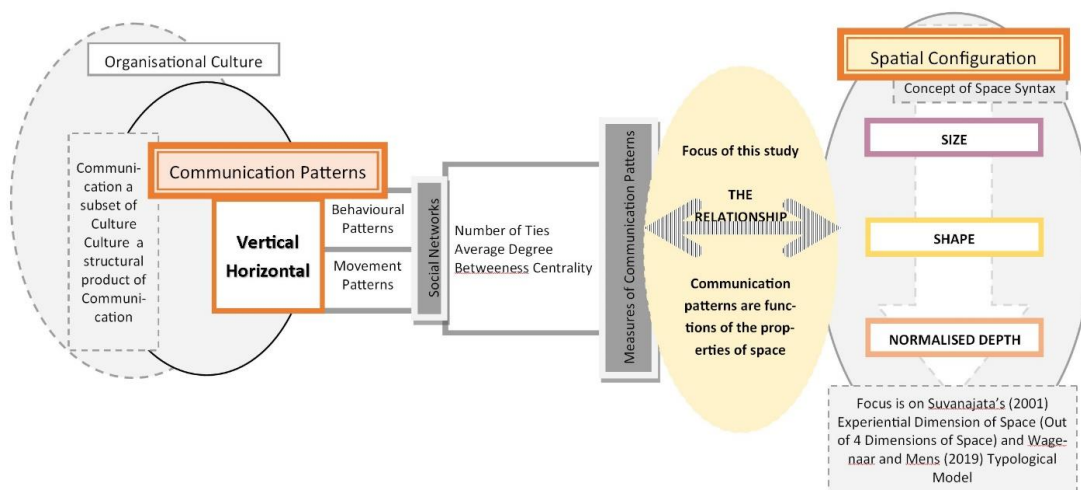

Figure 2: Theoretical framework showing the focus of the study. Thus, this forms a reasonable basis that this study sought to explore a relationship between a hospital's communication patterns and the spatial layout in the hospital environment. Thus, using the concept of space syntax to interpret and measure the characteristics of the spatial layout of hospitals and the concept of social network analysis to interpret the social interactions, which in this case portrays the patterns of communication in the hospital environment figure 2 elucidates the theoretical framework for this paper graphically.

## METHODOLOGY

To promote the understanding of the various phenomena in question, inform practice for similar situations and develop theory in hospital architecture, the case study method was proposed for the study. This was because the study sought to understand the phenomenon and relationship between spatial layout and hospital communication patterns. To study the case, a sequential transformative research design was used for the study. This allowed the theoretical perspective of the study to guide the research and determine the manner and order data was collected. The results were integrated at the end during the interpretation of the data collected. (Creswell, 2013).

**Table 1: Summary of Sequential Transformative Research Design and Objectives**

Obj	Step	Approach	Variables/instrument
1	Develop a Theoretical framework on Spatial layout and Organisational Communication in Tertiary Hospitals	Systematic Review of Relevant Literature on Spatial layout and organisational Communication Studies	Relevant Literature/previous empirical studies (30)
2	Evaluate the communication patterns prevalent in the different categories of space in the Hospital understudy	An observational analysis of behaviour and movement patterns using social network analysis to map out the social networks in the different spaces in the hospital and described based on the results for the interview survey.	<b>Variables</b> Number of ties Average Degree Betweenness Centrality <b>Instrument</b> CCTV cameras. UCINET SNA software
2	Assess the Spatial layout of the Hospital space based on Space syntax theory and methodology and using Wagenaar and Mens (2019) Typological Model for Hospital Classification	A spatial analysis of the spatial layout of the hospital (done in sections and as a whole) based on Visibility Graph analysis (Space Syntax Theory) Koutsolampros et al. (2019).	<b>Variables</b> Size Shape and Normalised depth of Spatial layout <b>Instrument.</b> Spatial Layout of Hospital, DEPTH MAP X software for Spatial analysis
3	Harmonising Data collected (Social network analysis and Spatial analysis) to assess the relationships between the concepts	A Statistical analysis using Pearson's correlation and Multiple Regression)	<b>Instrument</b> Microsoft Excel. Spearman's correlation, Multiple linear regression

Also, this study sought to grasp and investigate the dynamic relationship between the spatial layout and communication patterns in hospital environments, thus the use of the case study method. The aim was to have first-hand experience on the prevailing communication patterns in Tertiary hospitals, which most researchers argue to be universal. A summary of the research design is outlined in Table 1. This is the approach proposed for the study.

## Criteria

The classification of healthcare in Nigeria (which is country-specific and population dependent) is based on National Health care which is classified into a three-tier structure based on the Federal, State and local governments prevalent throughout the country (Cooke & Tahir, 2013).

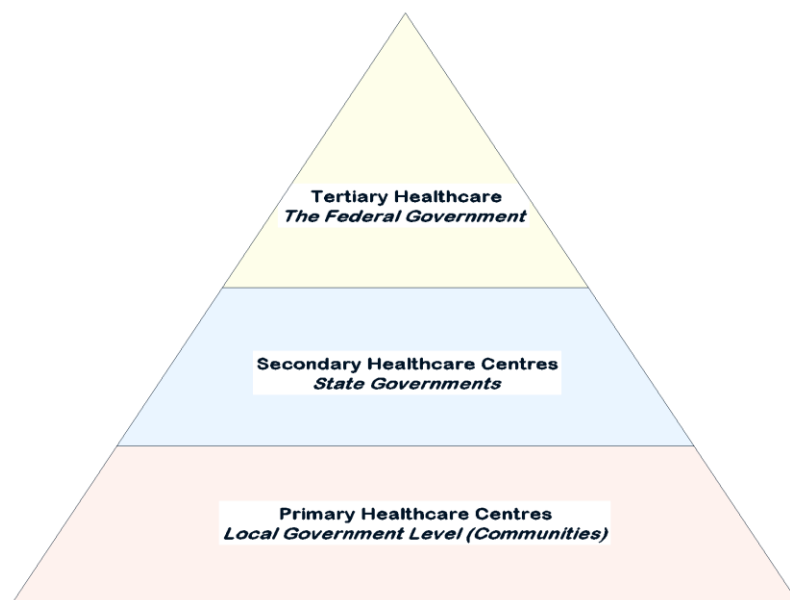

Figure 3: The Nigerian Healthcare Pyramid

Figure 3 shows an illustration of the Nigerian Healthcare pyramid, which has the Primary healthcare centres at the pyramid base and the Tertiary hospitals at their apex. The state-level is responsible for secondary hospitals through the state ministries of health (SMOH) and the regulation and technical support for primary health care services. At the Federal level, the Federal Ministry of Health (FMOH) is responsible for policy and technical support to the overall health system and Health service provision through tertiary and teaching hospitals and national laboratories. (Koce, 2018)

On paper, these three tiers have complementary roles, but in reality, the country's practicality in the country is not as seamless as itemised. The three-tier government healthcare delivery has been characterised by duplication and confusion of roles and responsibilities (Innocent, Uche and Uche, 2014). As a result, the focus of this paper was on tertiary hospital design.

The tertiary Hospital in Nigeria constitutes Teaching Hospitals, Federal Medical Centers and Specialty Hospitals distributed across the six geopolitical zones in the country. Out of the 60 tertiary hospitals, 27 (45%) are Teaching Hospitals, 20(33.3%) are Federal Medical Centers and 13 (21.3%) are speciality hospitals. According to Innocent, Uche and Uche (2014), in operationalising the 3 tiers of Healthcare delivery policy, the Federal Government of Nigeria decided to establish at least one tertiary Health institution in each state of the Federation, especially in areas that don't have Teaching Hospitals. In selecting an appropriate case for the study the research considered teaching Hospitals and federal medical centres. However, a closer look at the theoretical framework pointed out that the medical student, a



major stakeholder in Teaching Hospitals' communication patterns, was not considered in developing a theoretical framework for this paper.

Furthermore, the Federal Medical Centres scale across the states did not fully represent the complexity of social networks as highlighted by this study. On the other hand, the National Hospital Abuja provided a reasonable scale compared to the other Federal Medical Centres and represented to a greater extent the complex heterogeneous social networks in a hospital environment. Also, the National Hospital Abuja is regarded as a federal medical Centre and a speciality hospital. This study selected the National Hospital Abuja to study and understand the phenomena under consideration. This selection was because the Nigerian Healthcare system is organised in three broad categories; the primary, secondary and tertiary healthcare levels. While the local and state governments are responsible for providing primary and secondary health care, the federal government is responsible for providing tertiary care besides policy development and regulation. The tertiary hospitals sit at the apex of the hospital pyramid in Nigeria and serve as a reference for the primary and secondary health care units. The National hospital, Abuja, a tertiary hospital, provides a platform for the various aspects of communication in the hospital environment. It provides an environment that can accommodate the numerous communication patterns in the healthcare environment that both primary and secondary healthcare units cannot. Other tertiary hospitals like teaching hospitals were considered for the case study but could not be selected because of conflicting goals. Unlike the National hospital, which has its primary goal as the efficient delivery of health, the teaching hospitals have both the efficient delivery of care and teaching (knowledge delivery) as their primary goals. Thus, the teaching hospitals, though tertiary, does not provide the ideal for studying the concepts under consideration. Unlike the National Hospital in, Abuja the student-doctors and student-nurses dictate the hospital environment patterns largely. Furthermore, some communication in the teaching hospital environment is tailored towards the teaching of medicine and would create a bias in this research that is to teaching hospitals

### **The Architecture of the National Hospital, Abuja**

Though there are many views on the architecture of hospitals, Verderber(2000, 2003, 2008), Wagenaar and Mens, (2018), Adams (2008), to mention a few, this study assessed the National Hospital, Abuja based on Wagenaar and Mens (2018) typical hospital configuration. This consisted of four (4) types namely; the Theme Model, the Center Model, the Three-Flow Model and the Typological Model. The National Hospital, Abuja falls under the Typological Model, which distinguishes four types of spaces, namely; the "Factory" which houses technical functions, the "Office", the "Hot floor" (treatment area), and the Hotel (Patient ward) in other words, the spatial layout of the National Hospital was divided into 4 major categories, namely,

1. The Outpatient and Emergency Departments (The office)
2. Treatment and diagnostics Areas (Hot floor- the core of the hospital spatial layout))
3. Inpatient Wards (The Hotel)
4. Supporting Spaces-Mortuary, Restaurants, auxiliary spaces (The Factory House).

Plate 1 shows a google map of the National hospital Abuja, while figure 4 shows the spatial layout of the National Hospital Abuja.



Plate 1: Google map view of National Hospital Abuja

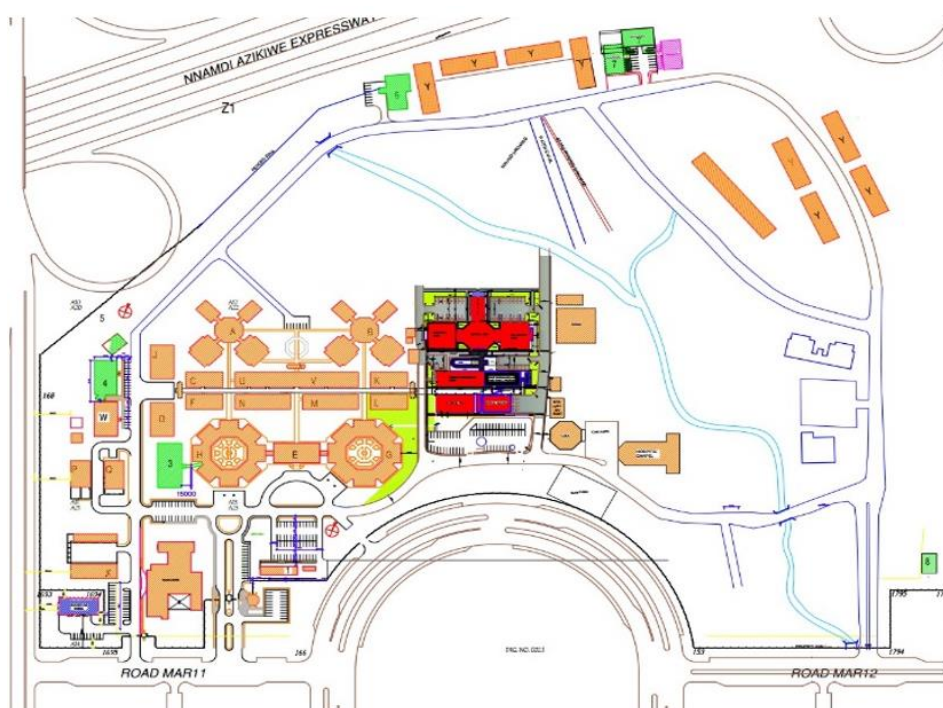

Figure 4: Site plan of the National Hospital Abuja

### Population, Sampling and Data Collection

It should be noted that the Population for this study focused on the Users within the spatial layouts in the Hospital environment being studied. These users included Doctors, Nurses, Patients, informal caregivers (specific to Nigerian hospitals) and other healthcare professionals who offer healthcare with these spaces. Concerning the samples, the social networks were observed at time intervals during peak work hours. Social networks were observed every 15 mins for eight hours from 7 am to

3 pm from Monday to Thursday for two weeks. This developed data of 32 social networks daily and a total of 250 social networks for eight days.

Using a Reolink Wireless Closed Circuit Television, the social networks were observed in the three distinct spatial layouts as opined by Wagenaar (2018). Social network data were translated to \*.csv format (Microsoft excel), visualised and quantified using the social network measure as highlighted previously using UCINET social network analysis software (Borgatti, Everett, & Freeman, 2002). Also, using as-built drawings of the hospital's spatial layout, DepthMapX, a space syntax analysing tool, was used to assess the spatial layout using three major spatial syntax variables, namely, the size, shape and normalised depth of the spatial layouts (Koutsolampros, Sailer, Varoudis, & Haslem, 2019). Using a Regression Statistical Model, this paper assessed the relationship between the spatial layout of hospitals and the observed communication patterns. The independent variables included the Shape, Size, and Depth of the spatial layouts. The dependent variables were the Number of Ties, the average degree, and observed social networks' diameter.

## RESULTS

The study developed data from three (3) independent but related sources. First, using the concept of space syntax, as stated earlier, DepthmapX was used to develop numerical data to characterise the spatial properties of three (3) categories of spatial configuration studied (outpatient department, treatment and diagnostics areas, and inpatient wards). The spatial metrics were focused on the size, shape and depth of the spatial layout. Second, using social network analyses, this paper focused on the number of ties, the average degree, and the diameter of the observed social network to understand and characterise the prevailing communication patterns in the investigated space categories identified previously.

The relationships between the two concepts of spatial configuration and communication patterns were modelled using multiple linear regression. Spearman's rank correlation between independent and dependent variables was developed as a basis for developing a regression model. The study checked for multicollinearity and homoscedasticity to develop an all-encompassing statistical model.

The results from this paper are divided into three parts, namely

1. The spatial analysis of the spatial layout of the hospital environment
2. The analysis of the observed social networks in the three spatial categories of the Hospital Environment
3. The regression analysis provided a peek into the relationship between the spatial layout and communication in the Hospital environment.

### **Spatial Analysis**

The results for the spatial analysis included three spatial layouts namely, the Outpatient and Emergency Units, the Treatment and Diagnostics areas and the Inpatient Wards. Table 2 illustrates a summary of the spatial characteristics of the spaces reviewed.

Spatial layouts	Spatial Metrics		Mean	Std Error	Median	Mode	SD	Sample Variance	Kurtosis
<i>Outpatient and Emergency Unit</i>	<i>Connectivity</i>	Size	35.55	0.658	28	5	27.19	739.20	-0.13
	<i>Visual Mean Depth</i>	Shape	5.53	0.039	5.54	1	1.60	2.56	2.13
	<i>Visual integration</i>	Depth	1.60	0.02	1.75	-1.00	0.75	0.57	-2.09
<i>Treatment and Diagnostics Areas</i>	<i>Connectivity</i>	Size	73.30	1.84	62.00	10.00	55.89	3123.96	0.44
	<i>Visual Mean Depth</i>	Shape	3.46	0.02	3.38	2.91	0.63	0.40	1.00
	<i>Visual integration</i>	Depth	3.13	0.02	3.06	3.82	0.73	0.53	0.12
<i>Inpatient Wards</i>	<i>Connectivity</i>	Size	164.86	2.09	181.00	260.0	94.48	8925.65	-0.40
	<i>Visual Mean Depth</i>	Shape	3.89	0.01	3.94	4.00	0.56	0.32	0.80
	<i>Visual integration</i>	Depth	3.13	0.02	3.06	3.82	0.73	0.53	0.12

Also, this paper conducted a test to ascertain the intelligibility of the spatial layouts in the hospital environment. The intelligibility is the correlation between the size of the spatial layout and the privacy of the spatial layout in this case its integration value. Table 3 compares the intelligibility value for the three distinct spatial layouts of the hospital design.

**Table 3: Intelligibility of the spatial layout in the National Hospital Abuja**

Spatial Layout	Intelligibility (Correlations between Connectivity and Integration ) P	P-Value
1 Outpatient Department	Connectivity – Integration	0.5
2 Treatment and Diagnostics Areas	Connectivity – Integration	0.8
3 Inpatient Wards	Connectivity – Integration	0.3

Source: Research Data 2020

### Social network analysis

As stated previously, social networks were used to assess the prevailing patterns of communication in the hospital under review. Table 4 below summarises the key networks variables used in this paper.

**Table 4: Social networks variables in the various spatial layouts**

Spatial Layout	Network Variables	Day1	Day2	Day3	Day4	Day5	Day6	Day7	Day8
Outpatient and Emergency Units	Number of Ties	172	188	210	188	124	147.6	138.0	128.4
	Average Degree	3	3.7	3.8	3.8	3.4	3.8	3.9	4.0
	Betweenness Centrality	40	38	44	46	57	57.6	61.8	66.0
Treatment and Diagnostics	Number of Ties	88	88	104	118	132	141.4	153.2	165.0
	Average Degree	3.5	3.5	3.9	3.9	4.4	4.5	4.7	4.9
	Betweenness Centrality	60	61	39	47	32	26.8	19.8	12.8
Inpatient Wards	Number of Ties	128	108	84	94	94	77.0	68.8	60.6
	Average Degree	4.13	4.15	3.65	3.76	3.2	3.1	2.9	2.7
	Betweenness Centrality	33	28	28	27	53	45.5	49.4	53.3

Figure 5 illustrates an example of a visualised social network with data generated from observations in the hospital environment

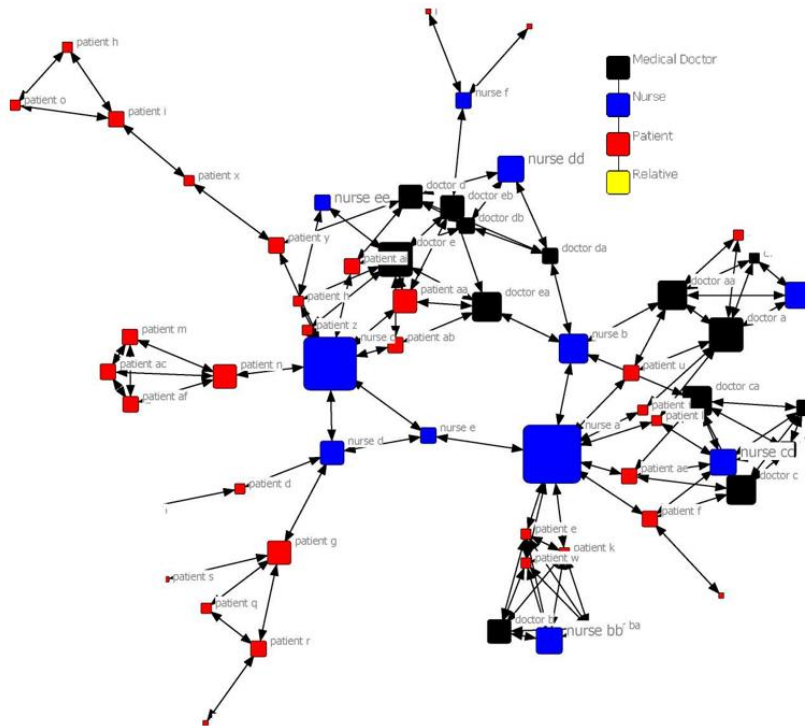

Figure 5: Social Network observed in the Outpatient and Emergency unit in the National Hospital Abuja.

Visualised by UCINET (Borgatti Everest & Freeman, 2002)

### Relationships between spatial layout and communication patterns

To explore relationships between the spatial layout in tertiary hospital design and the prevailing communication patterns in the hospital environment, a regression model was developed with the spatial metrics as the independent variable and the variable of the observed social networks as the dependent variables. Table 5 to Table 7 shows the results of the regression statistics between the two concepts.

**Table 5: Relationship between spatial layout and communication in multi-clinics and laboratories unit**

cc	Social Network Measure	Spatial Measure	Spatial Metric	P-Value	Coeff.	Variance
1	Number of Ties Average Degree Betweenness Centrality	Global properties	Mean Shortest Path Distance	0.04	7.32	R <sup>2</sup> =0.04
2	Number of Ties Average Degree Betweenness Centrality	The shape of Spatial Configuration	Isovist Compactness	0.001	38.99	R <sup>2</sup> =0.15
3	Number of Ties Average Degree Betweenness Centrality	Size of Spatial Configuration	Isovist Perimeter	0.026	0.045	R <sup>2</sup> =0.15
4	Number of Ties Average Degree Betweenness Centrality	Size of Spatial Configuration	Visual Entropy	0.04	-6.73	R <sup>2</sup> =0.005

**Table 6: Relationship between spatial layout and communication in the treatment and diagnostics areas**

	Social Network Measure	Spatial Measure	Spatial Metric	P-Value	Coeff.	Variance
1	Number of Ties Average Degree Betweenness Centrality	Size of Spatial Configuration	Isovist Perimeter	0.04	-0.021	R2=0.22
2	Number of Ties Average Degree Betweenness Centrality	The shape of Spatial Configuration	Isovist Max Radial Point First Moment Point Second Moment	0.05 0.01 0.02	0.012 -0.008 0.192	R2=0.07
3	Number of Ties Average Degree Betweenness Centrality	Normalised Depth	Integration (HH)	0.02	-4.60	R2=0.07

**Table 7: Relationship between spatial layout and communication in the inpatient wards**

	Social Network Measure	Spatial Measure	Spatial Metric	P-Value	Coeff.	Variance
1	Number of Ties Average Degree Diameter of Network	Shape of Spatial Configuration	Isovist Max Radial Point Second Moment	0.002 0.01	0.002 0.083	R2=0.099
2	Number of Ties Average Degree Diameter of Network	Normalised Depth	Integration (HH)	0.002	0.045	R2=0.095

## DISCUSSION

### Prevailing communication patterns

It was interesting to categorise the communication patterns prevalent in the Tertiary Hospital based on the Typological differences of its spatial layout.

Based on the results and characteristics of the social networks observed, The Outpatient Department had more Horizontal Communication Patterns due to the allocation of spaces to the different roles in the clinics investigated in the Outpatient Department and these patterns revolved around the Nurse roles which was the link between other roles in the social network. The Vertical communication patterns in the Treatment and Diagnostics areas was attributed to the specialised healthcare given in its spatial layout. This study concluded that each Role identified in the treatment and diagnostics area had interdependent activities which involved other roles to achieve effective healthcare delivery. Also, the Vertical Communication patterns in the Inpatient Wards highlight the routines of the professional roles in achieving effective healthcare delivery. The communication patterns revolved around the Patients social interaction on a routine basis with the Nurse and Doctor Roles.

### **Spatial analysis**

The Outpatient Department comprises three distinct but connected units in the National Hospital Abuja. They include the Emergency Unit, the Administrative Block and the Multi-clinics and Laboratories Unit. The Multi-clinics and the Emergency unit share similar Architectural Characteristics with a central octagonal shaped open courtyard with eight (8) categories of space arrayed around the courtyard. The Multi-Clinics and Laboratories Unit is made up of the Entrance and Waiting Area, the Medical Clinic, Obstetrics Clinic, Gynae Clinic and Diagnostic Suites, Paediatric Clinic, a Pharmacy and Service Area for Professionals and Recording Keeping. The Visibility Graph of the Multi-Clinics and laboratories shows the highest connectivity value of 110-112 in the Entrance and Diagnostics Suite. This is because the Connectivity metric is highly correlated with the Isovist Area (0.999). Thus, the size of the space and the position, in this case, allows the open spaces in the Entrance and Diagnostics Suite to have the highest connectivity. This means that in the spatial configuration of the Multi-Clinics and Laboratories Unit, the transition Areas (corridors/lobbies) in the Entrance and the Diagnostic Suites are important spaces due to their size and connection to other spaces in the unit. However, these characteristics address the frequency of the people and movement and do not necessarily translate to increased interaction within the said space. It did not come as a surprise that restrooms and sanitary areas located at different areas in the Multi-Clinics and Laboratories had the least Connectivity value ranging from 1-4. The Consulting rooms had the second-lowest Connectivity values which ranged from 6-24. The Spatial configuration of the Multi-clinics and Laboratories suggest an evenly spaced connectivity value that cut across evenly the various clinics in the Outpatient Area.

This is in line with this study which interprets the design of the Outpatient Department based on its structure that is its pattern of spatial arrangement, otherwise termed an Office Oriented Design.

As stated previously, the Treatment and Diagnostic Areas are at the core of the National Hospital Abuja. The Spatial configuration of this core area is linear with the major Hospital pedestrian passing through its centre. The Maternity Ward on the Ground Floor and the Intensive Care Unit on the First Floor were analysed as representations of the Treatment and Diagnostic area of the National Hospital, Abuja. The maternity area is characterised by an array of spaces arranged based on the processes in administering maternity treatment in the National Hospital, Abuja. From the entrance, the waiting, the delivery room and the ward to the Obstetrics theatre there is an intelligible line that maps out these processes chronologically. From its Connectivity value, the corridor which spans across the entire building has the largest connectivity value of 121. Though the spatial configuration of the Maternity ward has high connectivity with a single corridor that links all other space in the building, the spatial configuration has a high Visual Mean Depth that caters for the chronological processes in the Maternity Ward. For example, though the corridor spans the entire building, some of the spaces in the Maternity Ward can not be accessed from the corridor. Thus, concerning the Visual Mean Depth and Visual Step Depth, the Maternity Ward has high Visual Control especially with the reduction of the Integration Value



The Inpatient Wards in the National Hospital, Abuja is divided into three categories: the Male Inpatient ward, the Female Inpatient Ward, and the Paediatric Ward designed to cater to Children/Infants. The spatial configuration of the Inpatient Ward in the National Hospital is similar. Both the Male and Female wards with the Paediatric wards are all designed around a central core. For example, the Male and Female Ward is an inverted T-shaped plan with three wards arranged around a central core. Besides, the Paediatric Ward is an X-shape plan with the Paediatric wards arranged around a central core. The Visibility graph of the Inpatient ward has a very High Connectivity value of 324 compared with other spaces in the Hospital environment. This value is shared between the ward and the corridor in the inpatient ward. In other words, due to the high Isovist area in the Wards, the Connectivity is also high. The Visual Mean Depth and Visual Step Depth strongly correlate with the Inpatient Wards' Integration Value. The Visual Control is low compared to the other two space categories of the hospital partly due to the fact the wards can be accessed from more than an entrance. There is no strict space demarcation in the wards thus, the Visual Clustering Coefficient is high and allows for small groups to interact within the wards

### **Framework: spatial layouts and communication patterns in tertiary hospital design**

The framework outlines those aspects of the spatial configuration that are critical in terms of achieving effective communications in the Hospital environment. Since, this study assessed the National Hospital, Abuja, a tertiary Hospital based on the Typological classification postulated by Wagenaar and Mens (2019), the framework addresses the differences in the spatial layout by highlighting the key spatial measures to look out for in a bid to achieve effective communication between and among all the players represented in the Hospital environment. As illustrated, the framework addresses the three most distinct spatial types identified in the Hospital spatial configuration in the National Hospital, Abuja. The proposed framework addresses the design phase of a typical Tertiary hospital design and highlights key spatial measures like the Shape and Size of the spatial layout that affect the efficiency of communication patterns in the Hospital environment. The proposed framework further highlights the prevailing communication patterns in the different space categories in the Hospital environment. Figure 6 captures the proposed evidence design framework for Tertiary hospital design. (See next page)

## **CONCLUSION AND RECOMMENDATIONS**

This paper set out to redefine spatial layout in tertiary hospital design by focusing on the experience space offers, especially in hospitals. This was about Hillier and Hanson (1984) social logic of space, which suggested that the experiential dimension of space can be quantified. The focus was on communication patterns, and this paper conceptualised it as a subset of the hospital's organisational culture. Using the Hofstede (2015) concepts of organisational culture, this paper interpreted communication patterns as social interactions in the hospital environment, which can be seen in the hospitals' behaviours, attitudes, and values. Using the specific spatial metrics namely the size, shape and depth of spatial layouts in tertiary hospital design and the number of ties, average degree and betweenness centrality which identify communication patterns (Horizontal and vertical) through observed social networks in the Hospital environment, this paper



explored the relationship between hospital spatial layout and the prevailing patterns of communication. The following outlines the conclusions of this paper.

1. Communication Patterns is interpreted as the unique organisational communication that has a structure that is dependent on the unique Organisational Culture in the Hospital environment. This culture is expressed in attitudes. Values and behaviour of the players in the Hospital environment and can be classified into the Vertical and Horizontal Communication Patterns in the Hospital environment.
2. All attributed to hospitals' spatial layout, namely its function, structure and aesthetics, contribute to and determine the unique experience in each specific layout. Thus, the Spatial layout of a Hospital has a significant influence on the social constructs within the hospital environment. This experience caters to and is responsible for the movement and interaction within the spatial layout.
3. The prevailing communication pattern in the Outpatient Department, which comprises of the Emergency Unit and Outpatient clinics, is the Horizontal communication pattern consisting mainly of Similar roles (Doctor-Doctor, Nurse-Nurse and Patient-Patient roles).
4. The prevailing communication pattern in the Treatment and Diagnostics Areas is a Vertical Communication Pattern consisting of all the three roles considered in the observed social network.
5. The Inpatient Wards' prevailing communication pattern is a Vertical communication pattern among Doctor and Patient roles and Nurse and Patient roles. This is buttressed with the unique healthcare delivery, which is related but more independent of the two roles.
6. The Treatment and Diagnostics areas in comparison to the Outpatient Departments and Inpatient Wards in the wards studied has the strongest correlation ( $r= 0.70$ ,  $p<0.05$ ) between the way its functional spaces are connected (Connectivity) and the depth of its spatial layout (Visual Integration).
7. The Shape of the spatial layout can significantly predict the variance in communication patterns in the Outpatient Departments ( $\beta = 0.21$ ,  $p < .05$ ,  $r^2=0.045$ ), Treatment and Diagnostics Areas ( $\beta = 0.26$ ,  $p < .05$ ,  $r^2=0.063$ ) and Inpatient wards ( $\beta = -0.31$ ,  $p < .05$ ,  $r^2=0.10$ ).
8. The Size of the spatial layout can significantly predict the variance in communication patterns in the Outpatient Departments ( $\beta = 0.30$ ,  $p < .05$ ,  $r^2=0.15$ ) and Treatment and Diagnostics Areas ( $\beta = 0.05$ ,  $p < .05$ ,  $r^2=0.215$ ).
9. The Depth of the spatial layout can significantly predict the variance in communication patterns in the Treatment and Diagnostics Areas ( $\beta = 0.26$ ,  $p < .05$ ,  $r^2=0.07$ ), and Inpatient wards ( $\beta = 0.308$ ,  $p < .05$ ,  $r^2=0.10$ ).

Based on the conclusion in this paper, the following are recommendations;

1. The spatial metrics outlined in each of the space categories studied should guide Tertiary Hospitals' design.
2. The design of the Outpatient department, Treatment and Diagnostics Areas, and Inpatient Wards with regard to effective communication in tertiary hospitals should be done independently regarding the specific spatial metrics related to its communication patterns.

This study is characterised as an interdisciplinary study with backgrounds in Architecture and Sociology with a specific interest in Architecture and human behaviour in Hospitals. Thus, this paper suggests that further study be directed towards validating the findings in this paper through a comparative study of the two concepts in a representative sample of tertiary hospital design. Also, it would be interesting to explore the medical student as an additional player in the hospital environment. This would provide another complex to the theoretical framework proposed in this paper.

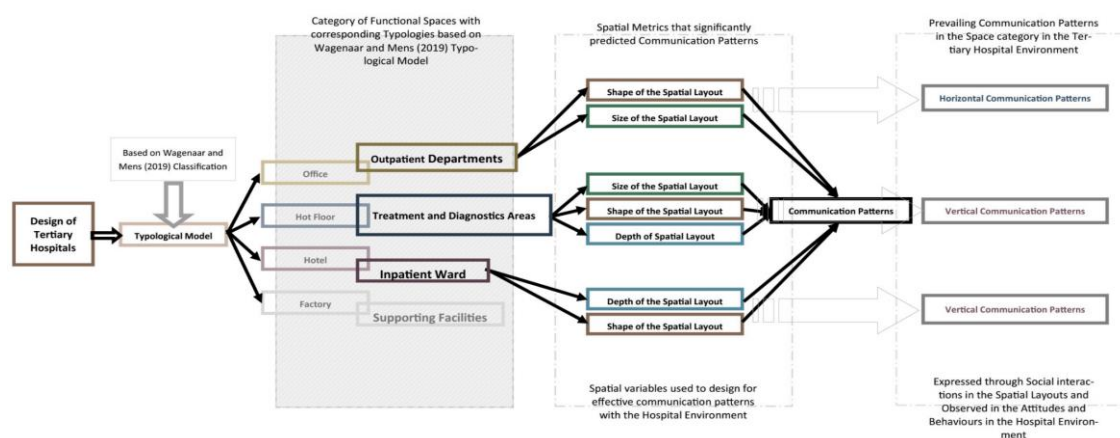

Figure 6: Proposed Design Framework showing the relationship between Spatial Layout and communication Patterns in Tertiary Hospital Design.

## REFERENCES

- Adams, A. (2008). *Medicine by Design: The Architect and the Modern Hospital, 1893–1943*. University of Minnesota Press. Retrieved from <http://www.jstor.org/stable/10.5749/j.ctttv5mt>
- Adisa, T. A., Adisa, T. A., Mordi, C., Mordi, C., Osabutey, E. L., & Osabutey, E. L. (2017). Exploring the implications of the influence of organisational culture on work-life balance practices: evidence from Nigerian medical doctors. *Personnel Review*, 46(3), 454-473. *Administrative Science Quarterly*, 44(4), 350-383.
- Alfonsi, E., Capolongo, S., & Buffoli, M. (2014). Evidence-based design and healthcare: an unconventional approach to hospital design. *Ann Ig*, 26(2), 137-43.
- Bafna, S. (2003). *Space syntax: A brief introduction to its logic and analytical techniques*
- Barasa, E. W., Molyneux, S., English, M., & Cleary, S. (2017). Hospitals as complex adaptive systems: a case study of factors influencing priority setting practises at the hospital level in Kenya. *Social Science & Medicine*, 174, 104-112.
- Borgatti, S. P., Everett, M. G. & Freeman, L. C., (2002). *Ucinet for Windows: Software for social network analysis*. Harvard, MA: analytic technologies, 6.).
- Cai, H., & Zimring, C. (2019). Cultural impacts on nursing unit design: A comparative study on Chinese nursing unit typologies and their US counterparts using space syntax. *Environment and Planning B: Urban Analytics and City Science*, 46(3), pp.573-594.
- Chichirez, C. M., & Purcărea, V. L. (2018). Interpersonal communication in healthcare. *Journal of medicine and life*, 11(2), p.119.

- Cooke, J. G., & Tahir, F. (2013). Maternal health in Nigeria. Center for Strategic & International Studies.
- Creswell, J. W., (2013). Steps in conducting a scholarly mixed methods study.
- De Negri, B., Brown, D. L., Hernández, O., Rosenbaum, J. & Roter, D. (1997). Improving interpersonal communication between health care providers and clients. Bethesda US, pp.3-59.
- Ezeah, G., Ogechi, E. O., Ohia, N. C. & Celestine, G. V. (2020). Measuring the effect of interpersonal communication on awareness and knowledge of COVID-19 among rural communities in Eastern Nigeria. *Health education research*, 35(5), pp.481-489.
- Innocent, E. O., Uche, O. A., & Uche, I. B. (2014). Building a solid health care system in Nigeria: challenges and prospects. *Academic Journal of Interdisciplinary Studies*, 3(6), 501. Instruments for exploring organisational culture: A review of the literature. *Public administration review*, 69(6), 1087-1096. *Journal of Management Studies*, 22(4), 347-35
- Jamoh, B., Abubakar, S., & Isa, S. (2018). Morbidity and mortality profile of patients seen in medical emergency unit of a Teaching Hospital in Nigeria: A 4-year audit. *Sahel Medical Journal*, 21(4), 213-213.
- Koce, F. G. (2018). Understanding healthcare self-referral in Niger state (Nigeria): the service users' and healthcare providers' perspective.
- Lee A., K., & Allen, B. J. (2003). The racial foundation of organisational communication. *Communication Theory*, 13(1), 5-38.
- Lee, J. H., Ostwald, M. J., & Lee, H. (2017). Measuring the spatial and social characteristics of the architectural plans of aged care facilities. *Frontiers of Architectural Research*, 6(4), 431-441.
- Lee, J. H., Ostwald, M. J., & Lee, H. (2017). Measuring the spatial and social characteristics of the architectural plans of aged care facilities. *Frontiers of Architectural Research*, 6(4), 431-441.
- Leedy, P. D., & Ormrod, J. E. (2005). *Practical research: Planning and design*, 8.
- Martin, G., Khajuria, A., Arora, S., King, D., Ashrafian, H. & Darzi, A., (2019). The impact of mobile technology on teamwork and communication in hospitals: a systematic review. *Journal of the American Medical Informatics Association*, 26(4), pp.339-355.
- McKinney Jr, E. H., Barker, J. R., Smith, D. R., & Davis, K. J. (2004). The role of communication values in swift starting action teams: IT insights from flight crew experience. *Information & Management*, 41(8), 1043-1056.
- Ogunola, A. A. (2015). The Relationship between Organisational Communication and Job Performance of Employees of Selected Nigerian Brewing Industries, 5(2), 85-92.
- Okonofua, F., Ntoimo, L., Ogu, R., Galadanci, H., Abdus-Salam, R., Gana, M., & Randawa, A. (2018). Association of the client-provider ratio with the risk of maternal mortality in referral hospitals: a multi-site study in Nigeria. *Reproductive health*, 15(1), 32
- Oladejo, E. I., Umeh, O. L., & Ogbuefi, J. U. (2015). An examination of impact of tertiary healthcare facility design on user needs and satisfaction in South East Nigeria. *Journal of Environmental and Earth Science*, 5(5).
- Pirnejad, H., Niazkhani, Z., Berg, M., & Bal, R. (2008). Intra-organizational communication in healthcare. *Methods of information in medicine*, 47(4), pp.336-45.
- Rees, G., & Smith, P. (Eds.). (2017). *Strategic human resource management: An international perspective*. Sage.

- Sailer, K., & Penn, A. (2007). The performance of space—exploring social and spatial phenomena of interaction patterns in an organisation. Paper presented at the International Architecture and Phenomenology Conference, Haifa.
- Sailer, K., Budgen, A., Lonsdale, N., Turner, A., & Penn, A. (2007). Effective workplaces: bridging the gap between architectural research and design practice. Paper presented at the The 6th International Space Syntax Symposium, Istanbul.
- Sailer, K., Budgen, A., Lonsdale, N., Turner, A., & Penn, A. (2009). Comparative studies of offices pre and post—how changing spatial configurations affect organisational behaviours. Paper presented at the Proceedings of the 7th International Space Syntax Symposium, Stockholm, KTH.
- Sailer, K., Pachilova, R., Kostopoulou, E., Pradinuk, R., MacKinnon, D., & Hoofwijk, T. (2013). How strongly programmed is a strong programme building? A comparative analysis of outpatient clinics in two hospitals. In Proceedings of the 9th international space syntax symposium. Sejong University Press.
- Sailer, K., Pachilova, R., Kostopoulou, E., Pradinuk, R., MacKinnon, D., & Hoofwijk, T. (2013). How strongly programmed is a strong programme building?: A comparative analysis of outpatient clinics in two hospitals. In 2013 International Space Syntax Symposium.
- Sari, Y. K. (2017). Influence of Organisational Culture and Communication on employee performance Bolong Karanganyar village through Job Satisfaction and Organisational Commitment. *eAbstract Excellent*, 2(2)
- Scott, J. (2017). *Social network analysis*. Sage
- Scott, W. R. (2004). Reflections on a half-century of organisational sociology. *Annu. Rev. Sociol.*, 30, 1-21
- Tahir, M., Haming, M., & Bijaang, J. (2018). Organisational communication effect on lecturer performance in Muhammadiyah University of Makassar
- Thompson, T. L., & Parrott, R. (1994). Interpersonal communication and health care. *Handbook of interpersonal communication*, 2, pp.696-735.
- Verderber, S. (2008). Evidence-based design for healthcare in post-Katrina New Orleans: current dilemmas. *HERD: Health Environments Research & Design Journal*, 1(2), 71-76.
- Wagenaar, C., & Mens, N. (2018). *Hospitals: a design manual*. Birkhäuser



## AN INNOVATIVE APPROACH FOR THE EVALUATION OF EXPANSION OPTION IN BUILDINGS

Yarima Sallau Lawal<sup>1</sup>, Aliyu Makarfi Ibrahim<sup>2</sup>, Mu'awiya Abubakar<sup>3</sup> and Ziyadul Hassan Ishaq<sup>4</sup>

<sup>1,2,3,4</sup>Department of Building, Ahmadu Bello University, Zaria, Nigeria.

Expansion option (EO) in buildings is more valuable when it is easier to achieve. Creating EO in initial building designs facilitate future expansion. However, this requires additional investment and the future is unknown whether or not the option would ever be exercised. This paper proposes an innovative approach for the evaluation of EO in buildings to avoid under or over-investment. Mathematical equations and algorithms were first developed based on the binomial method (BM) of real options analysis which were then implemented on a computer system. An algorithm was also developed for Monte Carlo simulation (MCS) and integrated with the binomial model. To illustrate its applicability, a real-life project was used to test the model. Sensitivity analysis was conducted to explore the influence of input variables on expansion option value (EOV). The result shows that inflation rate ( $i$ ), borrowing rate ( $b$ ), and rental value ( $R_i$ ) are the most sensitive variables for EOV. An increase in  $i$  and  $R_i$  by just 5% causes a corresponding increase in EOV by 16.26% and 10.60% respectively. While an increase in  $b$  by just 5% causes a corresponding decrease in EOV by 14.61%. However, the least sensitive variables appear to be the discount rate ( $r$ ) and volatility ( $\delta$ ). An increase in  $r$  by 5% causes a decrease in EOV by 6.9% while an increase in  $\delta$  by 5% causes an increase in option value by 5.85%. Also, the result shows that creating EO in the initial design adds over 10% value to a building. More so, by integrating the BM with the MSC method, EOV increases by 190%. The model builds upon a previously developed model for evaluating building development option (DOV) which was found to have a result accuracy of 80.77%. It was recommended that building investment decision-makers should combine both BM and MCS to obtain more reliable and sustainable results.

Keywords: binomial method, building investment, expansion option, Monte Carlo simulation, sustainable building development

### INTRODUCTION

Investment in building projects is often capital intensive with a long investment recovery circle amid multi-dimensional risks and uncertainties. According to Ellingham and Fawcett (2006), for economically sustainable building projects, it is

<sup>1</sup> yerimasallau@gmail.com

<sup>2</sup> aliyuibrahimmakarfi@yahoo.co.uk

<sup>3</sup> muawiyaabubakar1@gmail.com

<sup>4</sup> ziyadishaq2@gmail.com

necessary to ensure optimal investment – avoiding under or over-investment. Therefore, comprehensive evaluation of building projects is crucial especially in an era of economic downturn. However, despite the existence of whole-life costing (WLC) models, determining the economic benefits of buildings has been a difficult task due to the lack of reliable data and the inherent limitations of the existing WLC models (Tokede, Love & Ahiaga-Dagbui 2018). They added that the common approaches to investment appraisal for building projects are the payback period and discounted cash flow (DCF) techniques. The payback approach is unable to capture the time value of money and the lifetime of the investment (Christersson, Vimpari, & Junnila 2015). The DCF techniques include the net present value (NPV), internal rate of return, return-on-investment, and benefit/cost ratio, (Tokede, Love and Ahiaga-Dagbui 2018). The NPV method is the most widely used generally accepted approach for investment appraisal (Akkoyun 2012; Ma et al. 2012; Kishk et al. 2003; Boussabaine & Kirkham 2004). However, these traditional methods of investment appraisal used in WLC are unable to take account of the value of operational flexibility of a project and uncertainties in costs and benefits (Trigeorgis 1996; Cruz & Sanchez 2017; Peters, 2016; Fawcett 2011). Therefore, the need for innovative approaches to overcome some of the limitations of the DCF techniques.

According to Tokede, Love and Ahiaga-Dagbui (2018), mathematical modelling has been used for WLC which builds on the NPV method and it provides a relevant framework to assess the investment potential of buildings. Many researches have been conducted under the standard WLC approach and different models have been developed. However, under the standard WLC approach, decisions are made “now or never”. But, there is uncertainty in future costs, which include costs related to future changes to building uses, changes to resource consumption, and alterations to facilities throughout a building’s life (Ashworth & Perera 2013). Although Kishk et al. (2003) argued that the principles of WLC are well developed in theory, Tokede Love and Ahiaga-Dagbui (2018) encapsulated that there is convincing evidence that this is not the case. They added that there is room for improvement on the weaknesses of the standard WLC approach, especially in emerging building typologies. This brought about the need for a new generation WLC (Ellingham & Fawcett 2006) which uses lifecycle options (LCO) – flexible strategies incorporated in the initial design of a building which allows for alternative courses of action to be followed in the future (Fawcett, Hughes & Ellingham 2012).

LCO is in line with real options (RO) approach (Ellingham & Fawcett 2006) which is also another popular investment valuation method (Peters 2016; Tokede, Love & Ahiaga-Dagbui 2018). According to Kodukula and Papudesu (2006), the RO approach addresses the weakness of the DCF techniques. Katerina (2015) added that the best way to value a development project is through RO valuation theory. When using the RO approach, it is important to anticipate future trends (Tokede, Love & Ahiaga-Dagbui 2018) which can be modelled using the binomial tree approach (Menassa, 2011; Neroutsou & Croxford 2016). Therefore, this approach can guide building investment decision-makers in making better decisions to increase whole-life value (Ellingham & Fawcett 2013). Lawal and Ibrahim (2018) identified the types of LCOs to include development or deferral option, expansion or upgrade option, abandonment option, switching use option, option for new technology, reconfiguration option, refurbishment option, contraction option,

option to suspend project, and option to switch projects. This paper proposes a model for the evaluation of expansion options (EO) in buildings.

According to Ellingham and Fawcett (2006), most buildings have EOs but some are not recognised and incorporated in the initial design. They added that identifying and creating EO in initial building design facilitates future expansion and thus making it more valuable. Also, Stephen et al. (2016) stated that although the initial cost is increased by creating EO, but the flexibility for future expansion will be improved. Therefore it is obvious that EO adds value to a building but, it is created for uncertain and distant benefits. Since, creating EO in initial building design requires additional investment and the future is unknown whether or not the option would ever be exercised, therefore, it is crucial to evaluate the option's value. Ellingham and Fawcett (2006) stated that though, EO is common, it is usually not evaluated and mostly overvalued or undervalued. They further stated that undervaluing EO happens when future expansion is made unnecessarily expensive or impossible because EO was not initially created or retained, while overvaluing EO happens when resources are committed for unlikely expansion possibility. Hence, this paper develops a model for the evaluation of EO in buildings. The objective of this paper is to present a model that quantifies the value of creating EO in initial building designs.

## LITERATURE REVIEW

### Expansion Option (EO)

EO comes into play where an investment permits the present capacity to be increased (Peters 2014) i.e. when a building is capable of being expanded (Ellingham & Fawcett 2006). According to Cruz and Sanchez (2017), EO offers the option of increasing the productive scale of a project by making additional investment. Sun, Wang and Meng (2019) added that EO is a type of real option, whereby an investor has the right, but not the obligation, to expand the project's scale as market conditions change. That is, a developer can invest further into a project if conditions are favourable. Other authors pointed out that EO is equivalent to an American call option, given that it allows for the consideration of making an additional investment if a project is profitable (Copeland, Koller & Murrin 2000; Peters 2016). Peters (2016) added that the exercise price of EO is equivalent to the cost of creating the additional space discounted to the time of the option exercise. Schwartz (2013) and Peters (2016) stated that an investor may even accept a negative NPV on the initial evaluation of a project because of the possibility of high positive NPVs in the future. Therefore, take account of future uncertainty, some developers build on a small scale, and in the future if there is positive growth in demand, the scale can be expanded. Panayi and Trigeorgis (1998) agree that this "wait and see" approach significantly improves the project's value. The major decision under EO is to determine the value of creating EO and the right time to exercise the option (Lawal 2020). Ellingham and Fawcett (2006), outlined five factors upon which EO depends. These are:

1. Amount of uncertainty: EO is more valuable when there is high uncertainty.
2. Duration of option: EOs that are longer lasting or perpetual are more valuable.
3. Trigger point: EOs are more valuable if the probability of exercising the option is high.

4. Cost of exercise: EO is more valuable if the cost of exercising the option is low.
5. Resulting benefit: EO is more valuable if the resulting benefit is high when the option is exercised.

### Expansion Capacity (EC)

Expansion capacity involves the ability to increase facilities, space, or size over time to meet increased demand (Stephen et al. 2016). Stephen et al. (2016) added that the future expansion capability gives a building a real option that may be exercised at any time or never. The future demand determines the optimal time to exercise EO in the future. Stephen et al. (2016) suggested that EO should only be exercised when it has a positive NPV, as shown in Figure 1. This allows a developer to guard against the consequences of unfavourable circumstances and to benefit from the possible opportunities that may arise during implementation (Stephen et al. 2016).

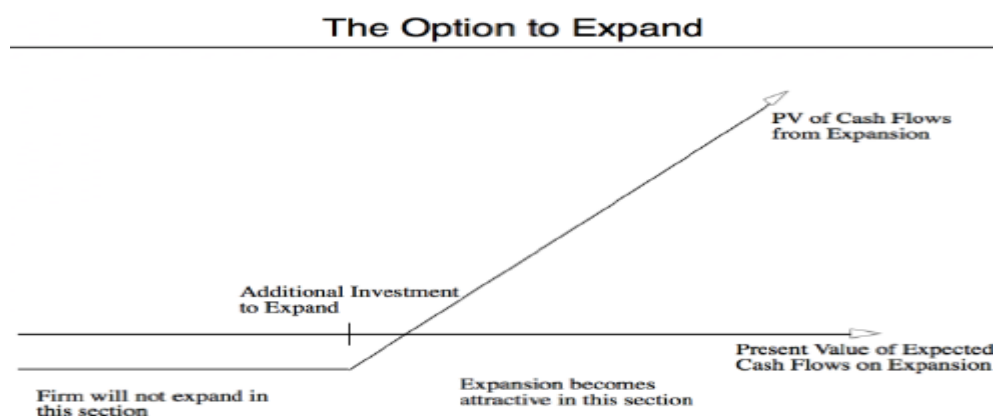

Figure 1: Positive NPV is needed to exercise expansion option (Source: Stephen et al. 2016).

### Real Options (RO)

RO is the right but not the obligation to undertake certain business initiatives, such as developing, deferring, abandoning, expanding, staging, or contracting a capital investment project. Real options analysis (ROA) originated from financial options and gained popularity after the development of the Black-Scholes option-pricing model (Kwabena et al. 2018). The term "real option" was introduced by Myers (1977). Copeland and Antikarov (2001) refer that an option holder has the right but not the obligation to exercise an option until its expiration date. According to Peters (2016), the common types of real options are the option to defer, option to expand or contract and option to abandon or switch. According to Peters (2016), the fundamental methods for ROA are the Black Scholes method (BSM) and the binomial method (BM). Peters (2016) added that the other methods are either an extension of these two or simulation-based models.

### Lifecycle Option (LCO)

The options approach to whole-life costing (WLC) was proposed by Ellingham and Fawcett (2006). The approach adopted the term 'lifecycle options' which provides the basis for a new generation WLC. The principle behind LCO is that rather than making decisions today when there is high uncertainty, it would be better if decisions are made in the future when more information becomes available. Fawcett, Hughes, and Ellingham (2012) defined LCO as a design feature that is incorporated in the initial design and construction of a building, which allows for alternative courses of action to be followed in the future. LCOs are an instance of



the more general concept of RO and they provide opportunities to respond to future changes (Fawcett, Hughes & Ellingham 2012). These future changes can emerge from (Tokede, Love & Ahiaga-Dagbui 2018):

- Economic benefits: e.g. saving future costs of building maintenance.
- Technological benefits: e.g. harnessing new and evolving technologies such as smart meters and control.
- Social benefits: e.g. response to legislative changes – asbestos ban
- Environmental benefits: e.g. minimising the embodied energy in buildings.

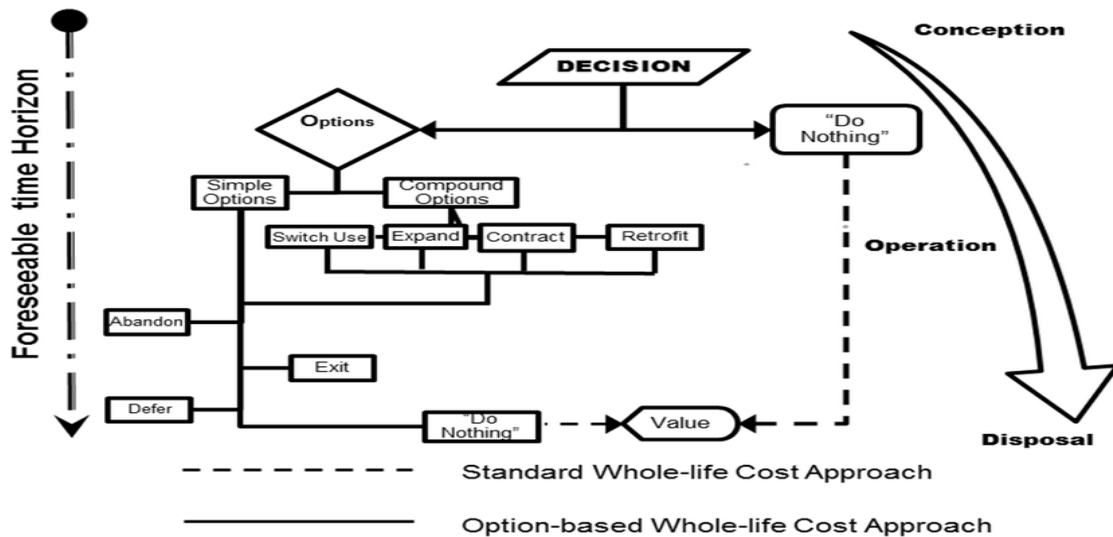

Figure 2: Mapping Whole-life Cost decisions in a Real-Options Framework (Source: Tokede, Love & Ahiaga-Dagbui 2018)

Figure 2 shows the decisions in the standard WLC approach and the options-based WLC approach. LCOs appraisal builds on scenario modelling and aims to foster the creation of options that ensembles optimal and long-term performances in buildings (Goh & Sun 2016).

### Binomial Method (BM)

The BM was first proposed by Cox, Ross, and Rubinstein (1979) and provides a general method for options evaluation (Peters 2016). The BM is suitable for representing uncertainty that increases over time and it has the advantage of being easy to build and understand (Lawal et al. 2021). Though it is sometimes computationally stressful, but it can be successfully implemented on a spreadsheet package. According to Mun (2002), although both BM and BSM are proven to provide reliable results, BSM has limitations of being very difficult to derive and highly specific (Mun 2002). Mun (2002), pointed out that the BM is easy to implement and explain because it requires no more than simple algebra.

### Monte Carlo Simulation (MCS)

Computer simulation can be used when there are uncertainties in input variables. MCS is a widely recognized tool that was introduced in capital budgeting problems by Hertz in 1968. According to Brealey, Meyers and Allen (2006), MCS can be used to generate all possible combinations of inputs and therefore, capable of generating the entire distribution of all possible outcomes. Loizou and French (2012) added that MCS assists decision-makers to be more rational and consistent

in their decisions and to gain a greater understanding of all of the risk factors in a development project.

### **Call and Put Options**

Peters (2016) and Ellingham and Fawcett (2006) stated that there are two basic forms of financial options which can be grouped into call and put options. According to Arnold (2014), a call option gives the option holder the right (but not the obligation) to buy a stock at a particular price within a specified period while a put option gives the option holder the right (but not the obligation) to sell a stock at a particular price within a specified time. Hence, the put option can be viewed as the opposite of the call option (Lawal et al. 2021). Arnold (2014) posited that the exercise of an option prior to maturity can occur if the option is an American option whereas a European option can only be exercised at maturity. Peters (2016) added that for the American option, an option holder has the right to exercise the option at any time during its life while for the European option, the option holder has the right to exercise the option only at the end of its life.

## **METHODOLOGY**

In this paper, an innovative model for the evaluation of EO in buildings has been developed to improve the economic sustainability of proposed building projects. Mathematical equations were developed based on the BM of real options analysis (ROA) first developed by Cox, Ross, and Rubinstein (1979). The mathematical equations were derived in line with ISO 15686-5 (Life-cycle costing) cost breakdown structure. Kirkham (2015), pointed out that ISO 15686-5 has addressed the issue of lack of standardization and lack of common cost breakdown structure in WLC. The mathematical equations were used to develop an algorithm for determining the value of creating EO in the initial building design. The algorithm was then implemented on a computer system using excel spreadsheet software. Besides, MSC was used to complement the BM which takes account of uncertainties in input variables. Another algorithm was also developed in form of a flow chart for the simulation which was also implemented on excel spreadsheet software. To ascertain the robustness and reliability of the model, real-life data was collected and used to test the model. Sensitivity analysis (SA) was conducted to explore the influence of the input variables on expansion option value (EOV). SA allows the evaluation of the relationship between different input variables and EOV and examines what can actually happen to a project in different situations (Brealey, Meyers, & Allen, 2006). SA is performed by changing some input parameters or one parameter at a time in a certain range while keeping other parameters unchanged and then calculates all the possible project values according to the changed parameters (Sattarnusart, 2012). This process will enable the project owner to identify all the key variables and to determine which input parameters are most likely to deviate from the estimated values (Sattarnusart, 2012). In this paper, SA was used to carry out a more in-depth analysis. However, the SA performed in this paper does not focus on determining the optimistic or pessimistic scenario of the project but rather, on studying how some of the input parameters affect EOV.

## RESULTS AND DISCUSSION

### Model Design and Development

The model was designed based on BM of ROA and in line with ISO 15686-5 (LCC) cost breakdown structure. The BM was tweaked to accommodate BEO. Besides, MCS was used to complement the BM.

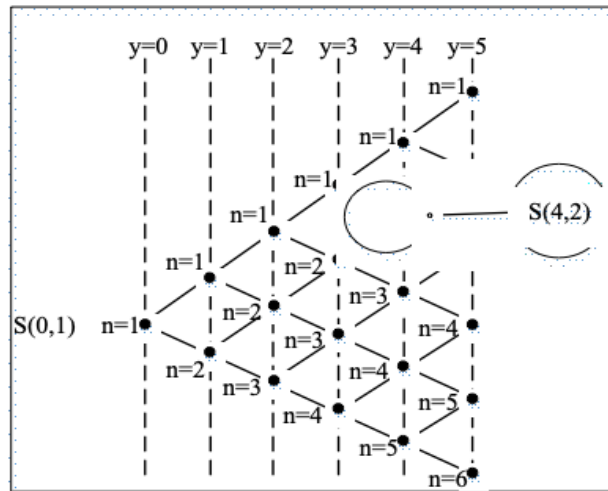

Figure 3: A Recombining Binomial Tree Showing Steps and States (Source: Lawal et al., 2021)

Figure 3 shows a five time-steps recombining binomial tree showing Steps (y) and States (n) as used in this work. Steps y represent the change in time on the binomial tree. The vertical dotted lines from 0 to 5 represent the steps (step 0, step 1, etc.). States n represents the number of nodes on each step. States (n) are represented numerically with numbers from top to bottom. All nodes on the binomial tree are represented as S (y, n). The highlighted node S (4, 2) is the node on step 4 and state 2. This applies to every node on the binomial tree.

### Mathematical Equations

This work is in a series of research carried out by the authors. This paper builds upon a previous model developed for building development appraisal (Lawal et al. 2021). Thus, the following were adopted for this work.

Equation [1] is used for computing Future Values (FV) on a binomial tree (Lawal et al. 2021):

$$FV_{(y,n)} = V_0 \times (1 + \delta)^{y-(2n-2)} \dots \dots \dots [1]$$

Where:  $FV_{(y,n)}$  = Futurevalue;  $V_0$  = Valueatstep0;  $y$  = step;  $n$  = state;  $\delta$  = Volatility.

A binomial tree can be discounted back to the present to obtain the Present Value (PV). Equation [2] is used for calculating the discounted weighted average of all entries on a binomial tree (Lawal et al. 2021):

$$PV_{(y,n)} = V_{(y,n)} + \left[ P_u \times \frac{V_{((y+1),n)}}{(1+r)} \right] + \left[ P_d \times \frac{V_{(y+1),(n+1)}}{(1+r)} \right] \dots \dots \dots [2]$$

Where;  $PV_{(y,n)}$  = PV at the node being studied,  $V_{(y,n)}$  = The entry/value at node (y,n),  $P_u$  = Upward probability,  $P_d$  = Downward probability,  $r$  = Discount rate.

### 1. Development Option Value (DOV)

Equations [3], [4], and [5] can be used for determining net present value (NPV) of development and development option value (DOV) (Source: Lawal et al. 2021).

$$NPVd_{(y,n)} = LCBD_{(y,n)} - LCCD \dots \dots \dots [3]$$

$$DVv_{(y,n)} = \text{Max}[NPVd_{(y,n)}, 0] \dots \dots \dots [4]$$

$$DOV_{(y,n)} = \text{Max}[DVv_{(y,n)}, Vd_{(y,n)}] \dots \dots \dots [5]$$

Where: LCCD = Lifecycle Cost of Development, LCBD = Lifecycle Benefit of Development, DVc = Development Cost, NPVd = Net Present Value of development,  $I_c = \text{Initialcost}$ ,  $C_c = \text{Constructioncost}$ ,  $N_c = \text{Non - constructioncosts}$ ,  $O_c = \text{Operatingcost}$ ,  $M_c =$

$\text{Maintenancecost}$ ,  $T_c = \text{Terminalcost}$ ,  $DVv_{(y,n)} = \text{DevelopmentValue}$ , DOV=Development Option Value

### 2. Expansion Option Value (EOV)

EOV is the savings made whenever the expansion work is carried out (Lawal 2020). Thus, the following equations were developed as follows:

- Cost of expansion without created option = Cost of creating the option at the time of expansion + Expansion cost.

Let, CEw = Cost of expansion without created option, Cw = cost of creating the option at the time of expansion, and Ec = Expansion cost. Thus;

$$CEw = Cw + Ec \dots \dots \dots [6]$$

- Cost of expansion with created option = Cost of creating the option in initial design + Expansion cost.

Let, CEo = Cost of expansion with a created option, Co = Cost of creating the option in the initial design, and Ec = Expansion cost. Thus;

$$CEo = Co + Ec \dots \dots \dots [7]$$

- Expansion saving = Cost of expansion without created option – Cost of expansion with created option.

Let, EOS = Expansion saving. Thus;

$$EOS = CEw - CEo \dots \dots \dots [8]$$

Using Equations [6], [7] and [8];

$$EOS = (Cw + Ec) - (Co + Ec)$$

$$EOS = Cw + Ec - Ec - Co$$

Thus;

$$EOS = Cw - Co \dots \dots \dots [9]$$

Therefore, EOS is the difference between the cost of creating EO at the time of expansion and the cost of creating EO in the initial design.

Equation [9] can be modified to suit Figure 3 as used in this work. This yields Equation [10]:

$$EOS_{(y,n)} = [Cz_{(y,n)} - Co] \dots \dots \dots [10]$$

Also, let, EVw = value of expansion without created option, EVo = value of expansion with created option, EOv(y,n) = value of creating EO in initial design, LCBD = lifecycle benefit of development and LCCD = lifecycle cost of development. From a whole-life perspective, EVw and EVo can be represented as follows:

$$EVw = LCBD_{(y,n)} - [LCCD + CEw] \dots \dots \dots [11]$$

$$EVo = LCBD_{(y,n)} - [LCCD + CEo] \dots \dots \dots [12]$$

Thus, EOS in terms of the lifecycle benefits and costs can be represented in Equation [13]:

$$EOS_{(y,n)} = Max[EVw_{(y,n)} - EVo_{(y,n)}, 0] \dots \dots \dots [13]$$

The value of creating an expansion option in the initial design ( $EOV_{(y,n)}$ ), is the backward discounting of all values on  $EOS_{(y,n)}$  binomial tree. This is the cumulative weighted average of all entries on the  $EOS_{(y,n)}$  binomial tree.

Therefore, let  $V^e_{(y,n)}$  be the cumulative weighted average of all entries on the  $EOS_{(y,n)}$  binomial tree. Using Equation [2] the value of creating EO in the initial design can be represented in Equation [14]:

$$V^e_{(y,n)} = V_{(y,n)} + \left[ P_u \times \frac{V_{(y+1,n)}}{(1+r)} \right] + \left[ P_d \times \frac{V_{(y+1),(n+1)}}{(1+r)} \right] \dots \dots \dots [14]$$

Since we are concerned with only positive NPVs, all negative values are replaced with zeros. Thus, expansion option value, EOV can be as follows:

$$EOV_{(y,n)} = Max[V^e_{(y,n)}, 0] \dots \dots \dots [15]$$

**Model Algorithm**

An algorithm was developed for computing the value of creating EO in the initial design. The algorithm was formulated into modules to make it more comprehensive. Figure 4 shows the algorithm for determining the value of creating EO in the initial building design. The modules are presented in Figures 4.1 to 4.15 in the Appendix.

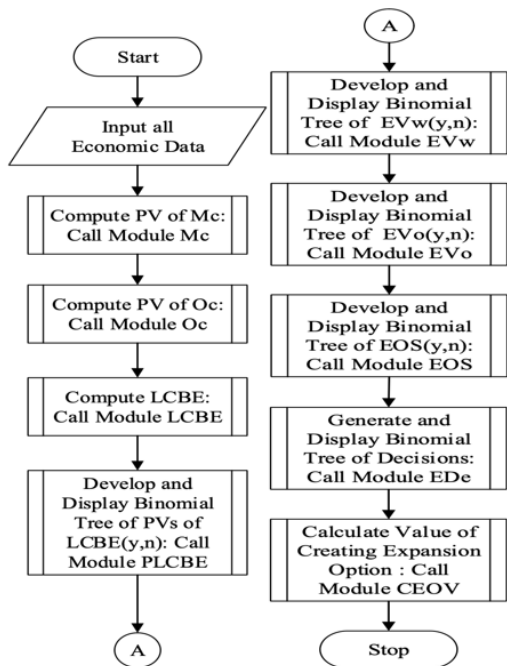

Figure 4: Algorithm for determining the value of creating EO

### Model implementation

The model was implemented on a computer system. Microsoft Excel Spreadsheet Software was used for the implementation of the model with the aid of the formulated algorithms.

### Model evaluation and testing

A proposed building project was used to test the reliability and validity of the model. The project has an approximate land area of 1,207.8m<sup>2</sup> and an overall building area of 529.60m<sup>2</sup>. An EO was created in the project. The EO is the option to expand the building by creating an additional floor. The following data was obtained and used in the model:

Construction Cost -	<b>₦34,424,000</b>	Volatility-	<b>11.4%</b>
Non Construction Cost-	<b>₦8,850,000</b>	Time Steps-	<b>1</b>
Maintenance Cost-	<b>₦6,884,800</b>	Borrowing Rate-	<b>11.75%</b>
Operating Cost-	<b>₦504,455/year</b>	Inflation Rate-	<b>11.25%</b>
Expected Benefits-	<b>₦1,600,000/year</b>	Terminal Cost-	<b>₦1,988,800</b>
Residual Value-	<b>₦8,690,000</b>	Analysis Period-	<b>30years</b>
Cost of creating EO in initial design-			<b>₦11,782,200.00</b>
Cost of creating EO at time of expansion-			<b>₦15,972,200.00</b>
Cost incurred due to non-creation of option-			<b>₦1,000,000.00</b>
At least 1 year of rental income to be lost-			<b>₦1,600,000.00</b>
Repair costs after creating option at the time of expansion-			<b>₦1,500,000.00</b>
Substructure-			<b>₦9,084,500.00</b>
Superstructure-			<b>₦25,339,500.00</b>
Roof-			<b>₦6,282,400.00</b>
Rental Value/ annum-			<b>₦1,600,000.00</b>

The development option value (DOV) model was used to determine the lifecycle benefit of expansion. From the results, the model suggests that EO should be created in the initial design. The value of creating EO in the initial building design over 30 years is 2.05 million. All through the option validity period, the value of creating EO in the initial design is positive meaning that EO should be created.

**Table 1: Value of creating EO in the initial design**

Yr	EVw (M ₦)	EVo (M ₦)	EOV (M ₦)	Yr	EVw (M ₦)	EVo (M ₦)	EOV (M ₦)	Yr	EVw (M ₦)	EVo (M ₦)	EOV (M ₦)
0	3.82	7.92	4.10								
1	5.06	8.20	3.15	11	11.64	14.07	2.43	21	16.00	18.21	2.21
2	6.17	9.21	3.05	12	12.21	14.59	2.38	22	16.45	18.62	2.18
3	6.86	9.71	2.84	13	12.60	14.97	2.37	23	16.78	18.95	2.17
4	7.72	10.49	2.77	14	13.13	15.46	2.33	24	17.21	19.35	2.13
5	8.28	10.96	2.68	15	13.51	15.83	2.32	25	17.53	19.67	2.14
6	9.02	11.64	2.62	16	14.02	16.30	2.29	26	17.95	20.06	2.11
7	9.51	12.08	2.57	17	14.37	16.65	2.28	27	18.25	20.37	2.10
8	10.17	12.69	2.52	18	14.86	17.10	2.25	28	18.67	20.74	2.08
9	10.62	13.11	2.49	19	15.20	17.44	2.24	29	18.97	21.05	2.07
10	11.23	13.67	2.44	20	15.67	17.87	2.20	30	19.37	21.42	2.05

Table 1 shows the results for the value of creating EO in the initial building design. The value of creating EO is higher in the early years and slightly reduces towards the latter years of a building. This agrees with Ellingham and Fawcett (2006), who concluded that EO depends on the duration of the option (longer-lasting options are more valuable). Also, the result shows that EVo (value of design with EO) is ₦ 21,415,951 and EVw is ₦ 19,365,116 (value of design without EO). This shows that the value of creating EO in the initial design is ₦ 2,050,835 (the difference between EVo and EVw). Therefore, EO creates an increase in the value of the building by about 10.6%. This indicates that creating EO in the initial design is very valuable because it adds over 10% value to a building project.

### Sensitivity Analysis (SA)

The SA performed in this paper does not focus on determining the optimistic or pessimistic scenario of the project, but rather on studying how some of the input variables affect expansion option value (EOV). The uncontrollable variables were changed to examine their effect on EOV. This was done by changing one variable at a time and fixing the others. All input parameters were fixed according to the base parameters in the project. From all the analyses, the effect of changing different variables on EOV can be summarized in Table 3.

**Table 2: Summary of the SA**

Input Parameters	EOV
Rental Value	+
Volatility	+
Borrowing Rate	—
Inflation Rate	+
Discount Rate	—

As shown in Table 2, an increase in rental value ( $R_i$ ) positively affects the option value. This agrees with Ellingham and Fawcett (2006), who stated that EO is more valuable when there are higher benefits. An increase in  $R_i$  by just 5% causes a corresponding increase in option value by 10.60%. Also, an increase in volatility ( $\delta$ ) creates a positive change in option value. This is also in agreement with Ellingham and Fawcett (2006), who concluded that EO is more valuable when there is more uncertainty. An increase in  $\delta$  by 5% causes a corresponding increase in value by 5.85%. However, the increase in  $EV_w$  and  $EV_o$  is the same (5.85% increase) which means their difference (EOV) remains constant. This means that an increase in  $\delta$  creates an equal and positive increase in both  $EV_w$  and  $EV_o$  with constant EOV. Moreover, an increase in borrowing rate ( $b$ ) has a negative effect on the option value. Since an increase in  $b$  will result in a higher cost of exercising EO, this also agrees with Ellingham and Fawcett (2006), who concluded that EO is less valuable if there is a high cost of exercising the option. An increase in  $b$  by just 5% causes a corresponding decrease in option value by 14.61%. More so, an increase in the inflation rate ( $i$ ) has a positive effect on EOV. Since an increase in  $i$  will result in higher expected benefits, this also agrees with Ellingham and Fawcett (2006), who concluded that EO is more valuable if there are large benefits. An increase in  $i$  by just 5% causes a corresponding increase in the option value by 16.26%. Lastly, an increase in the discount rate ( $r$ ) has a negative effect on the option value. An increase in  $r$  by 5% causes a corresponding decrease in the option value by 6.9%. Therefore, when evaluating EO in initial building designs, there are many variables as the inputs and inflation rate ( $i$ ), borrowing rate ( $b$ ), and rental value ( $R_i$ ) are the most significant variables. This implies that building investment decision-makers should carefully determine all the input parameters, especially the ones related to  $i$ ,  $b$ , and  $R_i$  to have a reliable result.

### **Simulation**

To determine the expected EOV and all possible EOVs, a Monte Carlo simulation was used. The objective of the simulation is to find the expected EOV and all possible EOVs.

#### ***Simulation design***

The design of the simulation follows the following steps:

1. Use the base values in the EOV model
2. Randomly select values for Rental Value ( $R_i$ ), Volatility ( $\delta$ ), Borrowing Rate ( $b$ ), and Inflation Rate ( $i$ )
3. Calculate EOV
4. Repeat until 10,000 iterations are reached
5. Use the values to produce a frequency curve
6. Identify the most likely EOV

The procedure of running the simulation can be described by the flow chart in Figure 5. MS Excel was used to run the simulation with the aid of the algorithm.



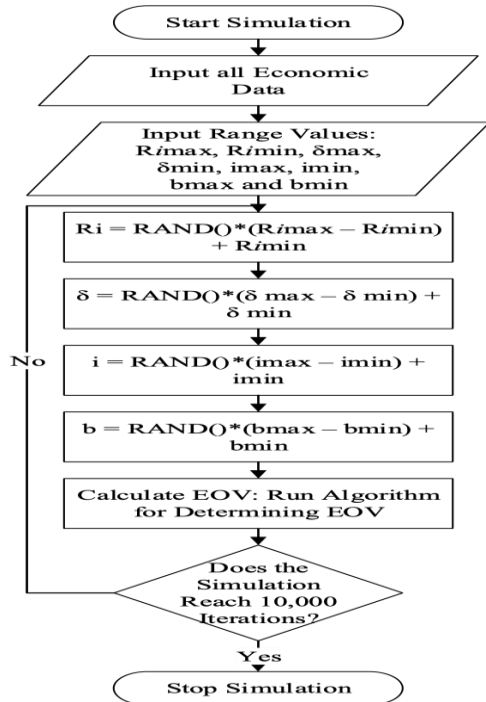

Figure 5: Flow Chart of EOV Simulation

### Simulation result and analysis – EO creation value

The possible values of EOV are plotted to examine the distribution of the results and the key statistical measurements are calculated for the analysis of the results. Figure 6 shows the distribution of all possible EOVs.

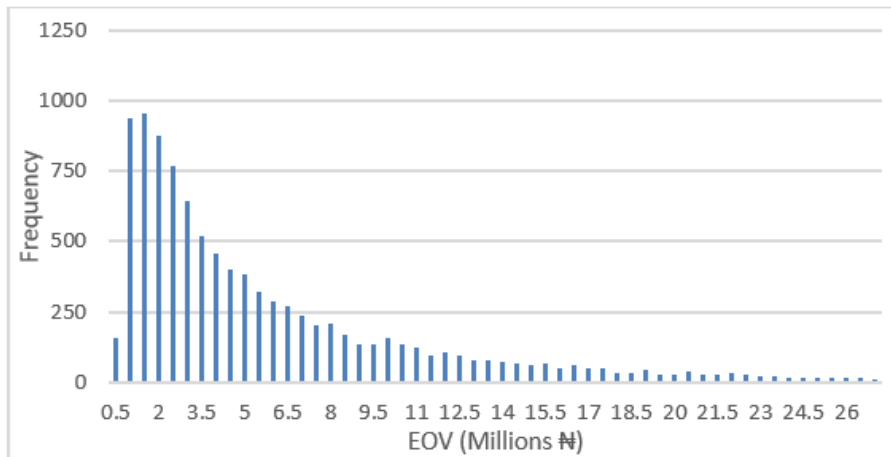

Figure 6: Distribution of Possible EOVs (EO Creation Value)

Table 3 shows the statistical results (EO Creation Value):

**Table 3: Statistical Measurement of EO Simulation (EO Creation Value)**

Statistical Measurement	Value
Maximum	38,791,649.01
Minimum	336,412.30
Standard Deviation	6,180,714.34
Average	5,948,189.92
Skewness	1.97
Kurtosis	4.17

The result shows that the most likely EO is ₦5,948,189.92. However, the EO obtained using only the BM is ₦2,050,385.00. This shows that by incorporating MCS into the analysis, EO increases by 190%. This difference has to do with the ability of the MCS method to take account of uncertainty in input variables. MCS method can generate all possible combinations of input variables. As such, the MCS method should be used to complement the BM for more reliable results. Also, from the result, the maximum EO happens to be ₦38,791,649.01 while the minimum EO is ₦336,412.30. This provides the best-case and worst-case scenarios. The model suggests that EO should be created in the initial design. The result from simulation suggests a higher value than that derived from the binomial model only. As such, there is the need to use both the BM and MCS together to make reliable and sustainable building investment decisions. This paper has proposed an innovative model capable of determining the value of creating EO in initial building design.

However, the major decision under EO is to determine the value of creating EO in the initial design and the optimal time to exercise the option. Therefore, there is a need to further expand the model to capture the value of exercising EO. Further research is ongoing which is aimed at expanding the model to be capable of predicting the most likely viable times over which EO could be triggered without affecting the value of a building project. After completing the research, the model should be capable of predicting the right times to exercise EO over a building's lifecycle. More so, to predict the optimal time of expansion, there is the need to generally improve the model using artificial intelligence (AI). With high uncertainty on the nature and times of possible future expansion, it is a difficult task to predict the optimal time of expansion. As such, there is the need to improve the model using AI-based algorithms.

## CONCLUSIONS

This paper proposes an innovative model for evaluating EO in buildings. The model, which is based on the BM of ROA, takes account of managerial flexibility and volatility in costs and benefits over the lifecycle of a building. The model is capable of determining the value of creating EO in initial building designs. The study concluded that inflation rate ( $i$ ), borrowing rate ( $b$ ), and rental value ( $R_i$ ) are the most sensitive variables for EO as an increase in  $i$  and  $R_i$  by just 5% causes a corresponding increase in EO by 16.26% and 10.60% respectively. While, an increase in  $b$  by just 5% causes a decrease in EO by 14.61%. However, the least sensitive variables appear to be the discount rate ( $r$ ) and volatility ( $\delta$ ) as an increase in  $r$  by 5% causes a decrease in EO by 6.9% while an increase in  $\delta$  causes an increase in option value by 5.85%. More so, creating EO in initial building design is very valuable because it adds over 10% value to a building project. Moreover, by integrating MCS and BM, EO increases by 190%. The study recommends that building investment decision-makers should use both the BM and MCS methods together for reliable and sustainable decisions. Further research is required to expand the model to be capable of predicting the right times to exercise EO. In addition, the model needs to be improved by using machine learning algorithms.

## REFERENCES

Arnold, T. (2014), *A Pragmatic Guide to Real Options*. 1st ed. New York: Palgrave Macmillan,

- Ashworth, A. & Perera, S. (2013). *Cost Studies of Buildings*. London: Routledge.
- Brealey, R. A., Meyers, S. C., & Allen, F. (2006). *Principles of Corporate Finance*. 8th ed. New York: McGraw-Hill/Irwin.
- Christersson, M., Vimpari, J., & Junnila, S. (2015). Assessment of financial potential of real estate energy efficiency investments: A discounted cash flow approach. *Journal of Sustainable Cities and Society*. 18 (1), 66-73.
- Copeland, T., Koller T., & Murrin J. (2000). *Valuation: Measuring and managing the value of companies*. 3rd ed. New York: Wiley.
- Copeland, T., & Antikarov, V. (2001). *Real Options: A Practitioner's Guide*. Texere, New York, NY.
- Cox, J. C., Ross, S. A., & Rubinstein, M. (1979). Option Pricing: A Simplified Approach. *Journal of Financial Economics*. 7 (3), 229. Available from: doi: 10.1016/0304-405X(79)90015-1
- Cruz, R. S., & Sanchez, P. A. (2017). The Option to Expand s Project: It's Assessment with the Binomial Options Pricing Model. *Operations Research Perspectives*. 4, 12–20. Available from: <http://dx.doi.org/10.1016/j.orp.2017.01.001>
- Ellingham, I., & Fawcett, W. (2006). *New Generation Whole-Life Costing: Property and construction decision-making under uncertainty*. 1st ed. UK: Taylor and Francis.
- Ellingham, I., & Fawcett, W. (2013). *Whole life sustainability*. RIBA.
- Fawcett, W., Hughes, M., & Ellingham, I. (2012). *Quantifying the Benefits of Open Building*. Paper delivered at the 18th International Conference on Open Building, 19th -21st November 2012, Beijing, pp. 146-153.
- Goh, B. H., & Sun, Y. (2016). The development of life-cycle costing for buildings, *Building Research & Information*. 44 (3), 319-333.
- Guma, A., Pearson, J., Wittels, K., de Neufville, R., & Geltner, R. (2009). Vertical phasing as a corporate real estate strategy and development option. *Journal of Corporate Real Estate*. 11(3), 144-157.
- Hertz, D. B. (1968). Investment Policies that Pay Off. *Harvard Business Review*. 46, 96–108.
- Kirkham, R. (2015). *Ferry and Brandon's Cost Planning of Buildings*. 9th ed. Chichester: John Wiley & Sons, Ltd.
- Kishk, M., Al-Hajj, A., Pollock, R., Aouad, G., Bakis, N., and Sun, M. (2003). *Whole Life Costing In Construction: A State-Of-The-Art Review*. RICS Research Paper Series.
- Kodukula, P. & Papudesu, C. (2006). *Project valuation using real options: a practitioner's guide*. Florida: J. Ross Publishing.
- Kwabena, M., David H., Judith C., & Ron, W. (2018). Staging Option Application to Residential Development: Real Options Approach. *International Journal of Housing Markets and Analysis*. 11(1), 101-116. Available from: <https://doi.org/10.1108/IJHMA-02-2017-0022>
- Lawal, Y. S. (2020). *Development of an Options-Based Whole-life Costing Model for Buildings*. An Unpublished M.Sc. Dissertation, Department of Building, Ahmadu Bello University, Zaria.
- Lawal, Y. S. & Ibrahim, A. M. (2018). Developing Options-Based Whole-life Costing Model for Buildings. *Proceedings of the 2nd Biennial Conference of the School of Postgraduate Studies*, 22nd – 26th October 2018, Ahmadu Bello University, Zaria, pp. 1248-1244.

- Lawal, Y.S., Ibrahim, A. M., Abubakar M., Ishaq, Z. H., & Sa'ad M. M. (2021). A Simulation-Based Binomial Model for Building Development Appraisal. *Journal of Engineering, Design and Technology*, Vol. ahead-of-print No. ahead-of-print. DOI: 10.1108/JEDT-02-2021-0094
- Loizou, P., & French, N. (2012). Risk and uncertainty in development: A critical evaluation of using the Monte Carlo simulation method as a decision tool in real estate development projects. *Journal of Property Investment and Finance*. 30 (2), 198-210.
- Ma, Z., Cooper, P., Daly, D., & Ledo, L. (2012). Existing building retrofits: Methodology and state-of-the-art. *Journal of Energy and Buildings*. 55, 889-902.
- Menassa, C. (2011). Evaluating sustainable retrofits in existing buildings under uncertainty. *Journal of Energy and Buildings*. 43 (12), 3576-3583.
- Mun, J. (2002). *Real Options Analysis: Tools and Techniques for Valuing Strategic Investments and Decisions*. New Jersey: John Wiley & Sons, Inc.
- Myers, S. C. (1977). Determinants of corporate borrowing. *Journal of Financial Economics*. 5(2), 147-75.
- Neroutsou, T., & Croxford, B. (2016). Lifecycle costing of low energy housing refurbishment: A case study of a 7 year retrofit in Chester Road, London. *Energy and Buildings*. 128, 178-189.
- Panayi, S., & Trigeorgis, L. (1998). "Multi-stage real options: the cases of information technology infrastructure and international bank expansion", *The Quarterly Review of Economics and Finance*. 38 (3), 675-692.
- Peters, L. (2016). *Real Options Illustrated*. Springer Briefs in Finance, Switzerland: Springer International Publishing.
- Schwartz, E. (2013). The real options approach to valuation: Challenges and opportunities. *Latin American Journal of Economics*. 50(2), 163-177.
- Stephen, S., Tony, R., Paul, C., & Hazem, E., (2016). Building an Expansion (Real) Option for a Hospital under Construction. 52nd Associated Schools of Construction (ASC) Annual International Conference Proceedings.
- Sun, H., Wang, Y., & Meng, J. (2019). A Trading and Pricing Method of Expansion Options for BOT Freeway Projects in China. *Journal of Engineering, Construction and Architectural Management*, 26(7), 1406-1423. Available from: doi: 10.1108/ECAM-03-2018-0123
- Tokede, O. O., Love, P. E., & Ahiaga-Dagbui, D. D. (2018). Life Cycle Option Appraisal in Retrofit Buildings. *Journal of Energy and Buildings*. Available from: doi: <https://doi.org/10.1016/j.enbuild.2018.08.034>
- Trigeorgis, L. (1996). *Real Options: Managerial Flexibility and Strategy in Resource Allocation*. Cambridge, MA: MIT Press.

## APPENDIX

### Modules

Figures 4.1 to 4.9 are the modules as used in the Algorithm.

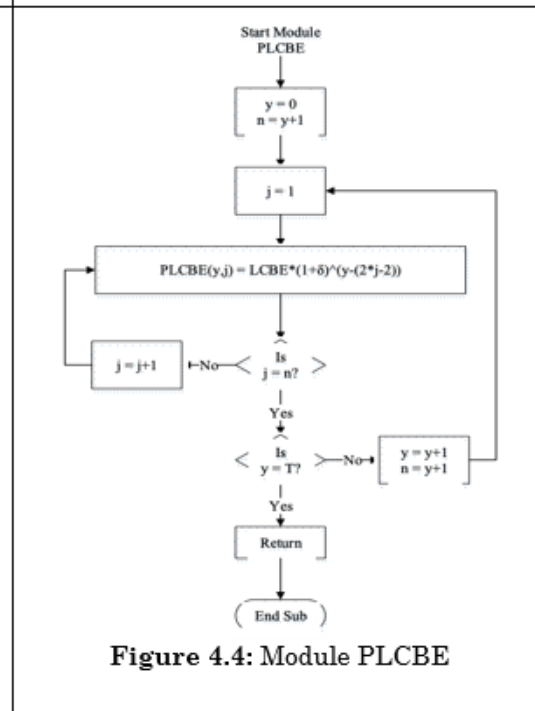
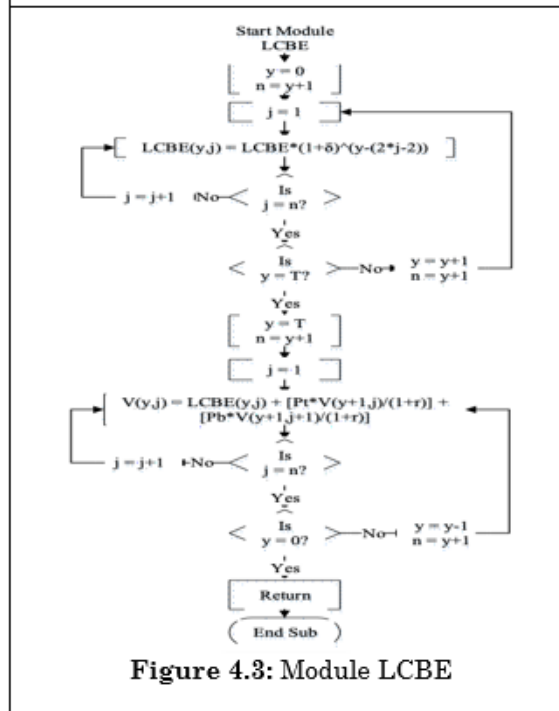
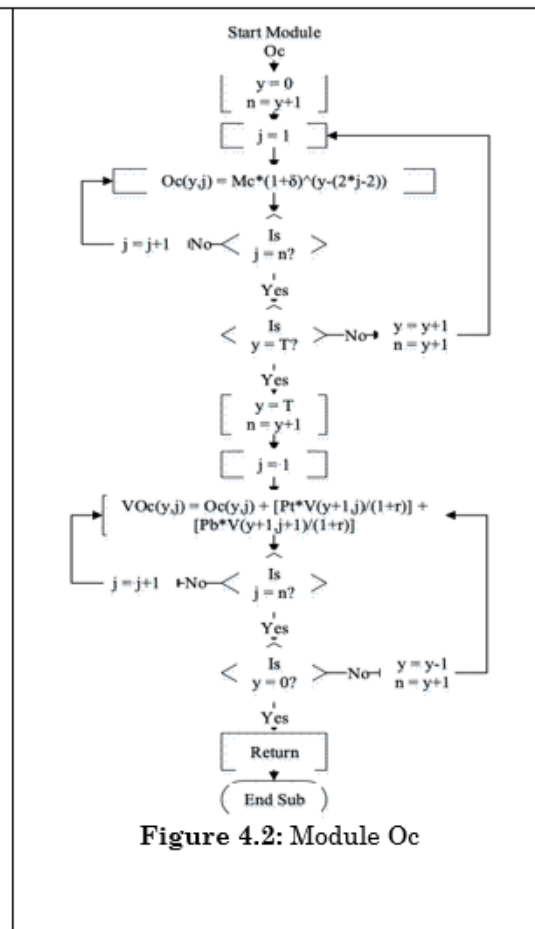
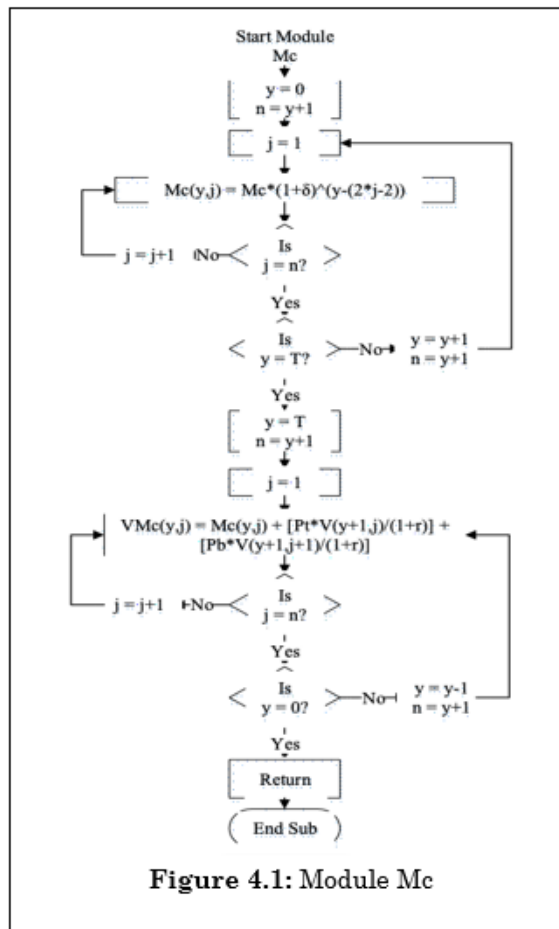

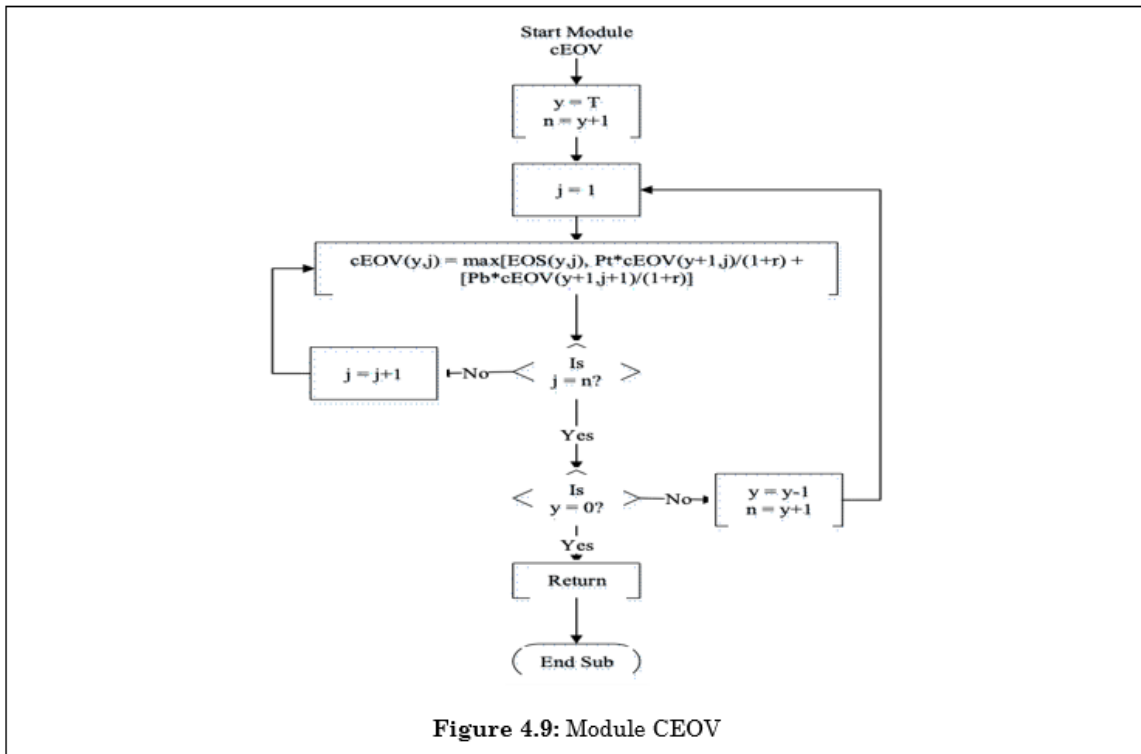



# AN INVESTIGATION INTO THE SAFETY PERFORMANCE OF PUBLIC BUILDINGS IN RELATION TO COMPLIANCE OF FIRE SAFETY REGULATIONS: A CASE STUDY OF ASHANTI AND GREATER ACCRA REGIONS OF GHANA

Samuel Asumadu Roberts<sup>1</sup> and Humphrey Danso<sup>2</sup>

<sup>1</sup>*Department of Building and Construction, Cape Coast Technical Institute, P.O Box DL155, Cape Coast, Ghana.*

<sup>2</sup>*Department of Construction and Wood Technology Education, Akyem Appiah-Menka University of Skills Training and Entrepreneurial Development, P. O. Box 1277, Kumasi, Ghana*

Ghana has experienced various forms of fire outbreaks emanating from domestic buildings, public buildings, industrial activities, and forests. It has become almost impossible to end a year in Ghana without recording incident of fire outbreaks that result in the deaths of individuals and loss of property. This study therefore aims at investigating the safety performance of public buildings concerning compliance with fire safety regulations in the Ashanti and Greater Accra regions of Ghana. A descriptive survey research design was adopted. The targeted population consisted of housemasters in public Senior High Schools and fueling station managers in Accra and Kumasi. Convenient and purposive sampling techniques were employed in selecting 72 housemasters and 384 filling station managers, and a questionnaire was used as a data collection instrument. The study found that the occupants of public buildings in Ashanti and the Greater Accra Region do not comply with safety regulations. It was also revealed that fire has caused many negative effects in Ghana from an economic perspective, population, safety, and security. A positive and significant relationship was found between compliance with fire safety regulation and safety performance of the public building ( $F=127.293$ ,  $df=308$ ,  $p<0.01$ ). It was recommended that building owners should ensure that their buildings are well equipped with active and passive firefighting equipment. Also, training on fire safety, first aid, use of firefighting equipment, and evacuation procedure should be made compulsory for all building occupants and at regular intervals. This implies that compulsory compliance of fire safety regulation will give a positive effect on public building structures in performing their required purposes.

Keywords: compliance, fire outbreak, public building, safety performance

## INTRODUCTION

Fire is one of the major hazards which may occur due to natural or man-made causes (Karake & Kulkarni, 2013). Fire posed great risk and challenges to early

---

<sup>1</sup> samuelasumaduroberts@yahoo.com

<sup>2</sup> hdanso@aamusted.edu.gh

people, including the challenge of setting and controlling fires and grappling with the threat of burn and wildfires. Fire continues to be a basic everyday element of most people's lives. However, improper handling and usage can lead to several accidents in homes, offices, schools, other public places with very serious repercussions (Ayarkwa, Danso & Adinyira, 2010). In 2019, Ghana recorded 5,673 fire outbreaks, 1,698 incidents were domestic fires as at the end of the third quarter as compared to 1,622 figures recorded in 2018. Commercial fires followed with 631 cases recorded, 606 for Bush fires, 502 for electrical fires, and 480 cases for vehicular fires. The report by GNFS in 2019 on fire outbreaks from January to September recorded a total number of 4,287 compared to 4,531 cases recorded in the third quarter of 2018. Figures from the Ghana National Fire Service (GNFS) have revealed that as of December 21, 2020, the country recorded 5,966 fire outbreaks. GNFS further noted that the recorded fire outbreaks represent a 4.9% increase compared to a figure of 5,673 in the same period in 2019. GNFS (2020) disclosed Ashanti Region recorded the highest number of cases and North East Region recorded the lowest. The report revealed that, although the significant rise can be attributed to the increase in domestic activities during the lockdown period, it also shows the citizenry has still not given fire safety protocols the urgency and attention it deserves.

According to Addai, Tulashie, Joe-Steve, and Yeboah (2016), Ghana happens to be losing a lot of money and resources due to numerous fire outbreak cases. There has been great emphasis on the provision of fire-fighting equipments for the fire service offices in the country. Millions of money are spent to train fire-men in fire combat, but little has been done to look at fire safety practices in buildings where there is likely to be the occurrence of fire. In most times, fire-fighters are being blamed for fire incident in a public building, and all this possible loopholes has been seriously explored (Addai et al., 2016) but little has been said or explored about the activity of the other stakeholders in the construction industry and usage of public buildings, who oftentimes responsible for the causes of fire outbreak. Fire safety regulation is an aspect that has suffered great neglect among designers and users of public buildings, this may be due to uncared attitudes and ignorance on the part of building owners and users. It has become almost impossible to end a year in Ghana without recording an incident of fire outbreak which results in the deaths of individuals and loss of property worth millions of Ghana cedis. From Kumasi to Accra, Wa, and the rest of the country, there has been a series of reports of deadly fire outbreaks. It is against this backdrop that an investigation of the relationship between the compliance of fire safety regulations and safety performance of public building is explored. The implementation of the findings and recommendations can be the foundation of a structured approach to safety management and minimizing the occurrences of fire outbreak in Ghana while ensuring buildings perform their required purposes.

## **LITERATURE REVIEW**

### **Building**

A building is a structure with a roof and walls standing more or less permanently in one place. Buildings come in a variety of sizes, shapes, and functions, and have been adapted throughout history for a wide number of factors (Economic Times, 2020). Buildings serve several societal needs-primarily as shelter from weather,



security, living space, privacy, to store belongings, and to comfortably live and work. Building can be for residential, or public commercial, industrial or other. Residential buildings are for people to live like house, flat etc. Public buildings are the cinema theatres, community halls, Railway station buildings, fueling stations, hospitals, schools, Aerodrome buildings, government office buildings wherein public persons will be visiting (Economic Times, 2020). Fire disasters experienced at the various residential and public building in Ghana repeatedly caused remarkable damages, which harmed the socio-economic development of the affected communities (Gakpe & Mahama, 2014). Addai, Gabel, and Krause (2016) indicated that fire incidents involving occupied premises often result in injuries, loss of assets, business disruption, and sometimes death.

### **Concept of building fire**

Fire is one of the major hazards which may occur due to natural or man-made causes. Fire is a rapid, self-sustaining oxidation process accompanied by the evolution of heat and light in varying intensities (Addai, et al., 2016). Fire starts in various ways and acts as a destructive force in human livelihoods (Asori, Dogbey & Dumedah, 2020). Building fires occur in buildings as a result of exposure to combusting materials like fuel and other flammable materials. Building fires are also classified based on materials, structures, and the building types (PAROC, 2017). Building occupants 'evacuation in cases of fire incidences depends on the fire resistivity of the material of construction. A building constructed mostly of combustible material will allow only but a limited time for evacuation. Building fire classification based on structure entails the response of the building elements or components (walls, roof, floors, ceiling, and construction systems) to fire. National Building Code of Finland (2011), also classified building fires into three classes (P1, P2, and P3), which are identified by building elements, building materials, and roof coverings. In building fire class P1, there is no restriction on the building height or number of storeys and accommodates more than 50 occupants. On the other hand, building fire class P2 may have either a single storey or two storeys and may accommodate a maximum of 50 people, while P3 building fire class may only have a single storey not having a height above 14 m. In a single building, different parts may belong to separate fire classes as long as fire spread is curtailed by a fire wall.

Fire outbreak is the most serious threat nowadays in Ghana (Asori et al., 2020). Fire outbreaks are generally caused by people through carelessness, ignorance, negligence, malicious ignition among others. This happens when the person handling the fire does not take it seriously and it gets out of hand. According Engel (2020) common causes of fire outbreak are faulty electrical outlets and old, outdated appliances, leaving gas and stove unattended whilst cooking, and careless handling of candles. In addition, Aliyu and Abdulrahman (2016), attributed the causes of fire to accident, faulty electrical equipment, fire spread and carelessness.

### **Effect of fire outbreaks in Ghana**

Fire has caused many negative effects in Ghana cutting from economic perspective, population, safety and security threat in the last decade. In 2015, fire outbreaks consumed the Goil fueling station at the Kwame Nkrumah circle in Accra. Over 150 people including woman and children lost their lives (Gadugah, 2016). Anane (2016) affirmed that between January and September 2016, the country further lost

approximately US \$21 million in property damage, a 50% increase from the total cost of items damaged in 2015. In the first quarter of 2016, the GNFS reported the Ashanti region are the region with the highest reported cases of fire incidence (Anane, 2016). In the latter part of 2016, the country was hit yet another major fire at the Ghana international trade fair center resulting in size deaths (Ibrahim, 2016). The central medical stores of the Ghana health service (GHS) in Tema which houses medical supplies for distributive to medical facilities nationwide was destroyed by fire in the early parts of 2015. An estimated US \$81 million of medical supplies and equipment was lost (Pharmaceutical Society of Ghana, 2016). In March 2016, over 110 shops and stores were totally destroyed during yet another fire outbreak. Figures from the GNFS reveal that 33 people perished while 239 sustained varying degree of injury in fire disaster in 2017(GNFS, 2017).

As indicated by GNFS, 2020, little less than 6,000 fires torched different parts of Ghana destroying properties and lives in 2020. Significant places that were destroyed by fire include Kantamanto Market, GCB Liberty House branch, shops in Koforidua Market, UEW laboratory, shops in Takoradi Market, two halls of Accra academy senior high school and many others. The damage the fire caused to properties was estimated at GH¢28,421,058.18 (GNFS, 2020). In under year review, fire outbreaks have resulted about hundreds of burned shops at Mallam Atta Market, and also properties, livestock destroyed as fire burns down orphanage at West Mamprugu. In the Kumasi Metropolis, fire destroys shops and houses at Bantama leaving families distressed and uncertain about their future (Ghana News Agency, 2021). Also fire engulfs the administration block of the Mampong College of education where academic activities came to holds (Ghana News Agency, 2021). Most of these fires whether domestic, industrial, institutional, commercial, vehicular comes with devastating consequences, including loss of lives and properties.

### **Fire safety regulations in Ghana**

To ensure the safety of all public, residential and industrial buildings across the country, the government together with the Ghana Standards Authority (GSA) established the Ghana Building Code. In exercise of the powers conferred on the Minister responsible for Works and Housing by Section 63 of the Local Government Act of 1993 (Act 462), and in consultation with the Minister responsible for Local Government, the national building regulations of 1996 (LI 1630) were enacted on 27th of September, 1996 (Republic of Ghana, 1996). This code determines the standards required for all construction works. In Areas where a naked fire is predominant, it is not recommended to use timber for internal and external walls. In earthquake prone areas, special attention must be given to foundation and superstructure design and construction (Tettey, 2011). Roofs need to be wind/rain storm resistant and concrete foundations are better in flood prone areas. All electrical materials used must be approved by Ghana Standard Board or other competent authority and electrical installations must be carried out by qualified professionals. All buildings must have fire detection, fire alarm and firefighting devices and be protected with a well-grounded lightning arrester. All portable L.P.G bottles shall be located outside the building when in use (Tettey, 2011).

Ghana National Fire Service Legislative Instrument (LI) 1724, Act 53 Fire Precautions Premises Regulations was enacted to ensure fire safety. Fire Precaution (Premises) Regulations, (LI 1724) is a legislative instrument which makes it obligatory for

certain premises to have fire certificates to meet fire safety standards (GNFS, 2016). According to the LI, there is the need to ensure that there are adequate exits within the premises for easy evacuation, serviceable fire-fighting facilities, among other interventions. The LI is applicable to all non-domestic premises and the common parts in some domestic properties. The LI 1724 places greater emphasis on fire prevention in all non-domestic premises, including the voluntary sector and self-employed people with premises separate from their homes. The Ghana National Fire Service (GNFS) has deployed task force to ensure that institutions comply with basic fire rules and regulations to curb the prevalence of domestic fires. This move by the Service has become necessary due to the upsurge in fires at buildings in the country.

## **METHODOLOGY**

### **Research approach**

Quantitative research approach was adopted for this study. The views of the occupants of the public buildings in Ashanti and the Greater Accra Regions were analyzed quantitatively. Quantitative research was employed because it aims to make numerical predictions, establish facts and test hypotheses that have already been stated.

### **Research design**

Descriptive survey research design was employed. A survey research design was used because it is fact finding in nature. This helped the researchers to analyse and interpret the current state of the people involved in the study, provides analyses and helped in the interpretation of data for the guidance of the future course of action. Considering the nature of the study, the descriptive survey design was deemed appropriate in terms of collecting data from a large group of respondents.

### **Population**

For the purpose of the study, the target population consisted of all the 31 and 15 public Senior High Schools in the Greater Accra and Kumasi Metropolis respectively, and 702 and 560 filling stations in the Greater Accra and Kumasi Metropolis respectively. The accessible population consisted all the housemasters in 6 public Senior High Schools, and 384 fueling stations at each Metropolis. The selected population was based on the frequent usage and rate of fire cases on facilities.

### **Sample size and sampling technique**

In determining the sample size for the public schools in the Greater Accra and Kumasi Metropolis, stratified sampling technique was used to select six schools from each Metropolis. The researchers first divided the population into sub groups (strata). The strata included girls 'schools, boys 'schools and mixed schools. After dividing the population, a simple random sampling method was used to select two schools from each sub group. From the target population, a sample of 72 housemasters were selected for the study from the six public schools in each Metropolis using simple random sampling method. In selecting the fueling stations, purposive sampling technique (Judgmental sampling) was used. Since every fuelling station in the Metropolis cannot be reached, this study selected three hundred and eighty-four (384) comprising 192 from each Metropolis using

judgmental sampling. The researchers on the other hand used their value judgment to select managers from each selected fuelling station from the population whose opinions were relevant to make a valuable decision. The determination of sample size was in line with Smith and Albaum (2005) equation for a very large population size.

### **Data collection instrument**

Questionnaire was used for collecting the necessary information from the respondents. The questions developed were adapted from literature, and some were confirmed in a series of interviews with the officials of GNFS. The questionnaire was divided into two (2) sections A and B. Section "A" consisted of personal information of the respondents, whereas Section "B" was made up various questions that answer the developed research questions. The section B reflected the constituents of the 5-Point Likert scale of which the occupants of the public buildings were expected to respond to the statements raised.

### **Data analysis**

The data collected was processed and analysed with the aid of Statistical Package for Social Sciences (SPSS) version 20.0. The following data analysis were used in the study:

- Frequencies, percentages, Mean and standard deviation: This was used to summarize the data.
- Exploratory factor analysis. For the purpose of validating the measurement instrument an exploratory factor analysis was used.
- Correlation analysis. According to the presumption of the proposed impact between fire outbreaks cases (FOC) and public building (PB), the test of measuring the association of variable was Pearson correlation.
- Regression analysis. Regression analysis was used in order to analyze the relationship between the dependent variable and independent or predictor variables.

## **RESULTS**

### **Compliance of safety regulations in the public building**

This section of the paper addresses the extent to which public buildings in Ashanti and the Greater Accra regions comply with fire safety regulations in Ghana. Mean ( $\bar{X}$ ), and standard deviation (SD) were computed. Table 1 presents the results.

From Table 1, the respondents agreed that they avoid overloading of electrical circuits ( $\bar{x}=3.97$ ,  $SD=1.064$ ). Moreover, the respondents also agreed that the means of escape is provided at the public buildings ( $\bar{x}= 3.95$ ,  $SD=1.018$ ). Concerning whether physical accessibility to building is provided, majority of the respondents agreed to that ( $\bar{x}= 3.95$ ,  $SD=1.034$ ). On whether more ventilation point is created in public buildings, the respondents agreed to the statement ( $\bar{x}=3.92$ ,  $SD=1.041$ ). Whether the occupants are cautious when using naked flames, the respondents agreed to that effect with a score of ( $\bar{x}=3.90$ ,  $SD=0.994$ ).

On the other hand, the respondents disagreed to the provision of fire hydrant, provision of emergency lightening system, availability of fire buckets, availability

of fire blanket, availability of wet riser and provision of fusible link door at the various public buildings. The respondents further disagreed to availability of fire hose reel, provision of smoke detectors, availability of sprinkler, provision of halon gas system, and provision of heat detector, at the various public buildings. These statements failed to meet the cut-off point of 3.0. The result shows that the majority of occupants of the public building do not comply with fire safety regulation in Ghana.

**Table 1: Responses on compliance of fire safety regulations in the public buildings**

S/N	Compliance of fire safety regulations	Mean	Std. Dev.	Decision
1.	Avoid overloading of electrical circuits are obeyed	3.97	1.064	Agreed
2.	Means of escape is provided	3.95	1.018	Agreed
3.	Physical accessibility to building is provided	3.95	1.034	Agreed
4.	Creation of more ventilation point	3.92	1.041	Agreed
5.	Cautious when using naked flames are complied with	3.90	.994	Agreed
6.	Perimeter vehicle access for emergency vehicles are complied with	3.89	1.078	Agreed
7.	Cautious switching-off all un-used electrical outlets	3.87	1.028	Agreed
8.	Fire exits are provided	3.77	1.125	Agreed
9.	Fire safety regulations on the provision of signs and notices are adhered to	3.72	1.166	Agreed
10.	Fire alarm is available	3.53	1.226	Agreed
11.	Portable fire extinguishers are available	3.44	1.314	Agreed
12.	Fire hydrant is provided	2.36	1.177	Disagreed
13.	Emergency lightning system is provided	2.26	1.145	Disagreed
14.	Fire buckets are available	2.26	1.136	Disagreed
15.	Fire blankets are available	2.24	1.177	Disagreed
16.	Wet riser is available	2.19	1.116	Disagreed
17.	Fusible link door is provided	2.14	1.000	Disagreed
18.	Fire hose reel is available	2.10	1.041	Disagreed
19.	Smoke detectors are provided	2.09	.982	Disagreed
20.	Sprinkler system is available	2.07	.954	Disagreed
21.	Provision of halon gas system is adhered to	2.02	.933	Disagreed
22.	Heat detector is provided	2.00	.964	Disagreed

Note:  $X < 3.0 = \text{Disagreed}$ ;  $X > 3.0 = \text{Agreed}$

### ***Principal factor analysis on compliance of fire safety regulations***

An exploratory factor analysis was performed on all the 22 variables. The tests were required for the appropriateness of the factor analysis for the factor extraction, including the Kaiser-Meyer-Olkin (KMO) measure of sampling accuracy, anti-image correlation, measure of sampling activities (MSA) and Barlett test of Sphericity. The results of the KMO test showed a coefficient value of 0.915. The factor loading is presented in Table 2.

After the Varimax Rotation converged in 22 iterations with a Kaiser Normalization, all three factors were named (Table 2). The naming of the factors was done by the researchers based on the variables association with literature. The main projections of the statements offered in the questionnaire on the first factor (F1) are those related to compliance of fire safety management. This encompasses motives such

as means of escape is provided, cautious when using naked flames are comply, perimeter vehicle access for emergency vehicles are complied with, cautious switching-off all un-used electrical outlet, fire exits are provided, fire alarm is available, fire hose reel is available, and emergency lightning system is provided.

**Table 2: Factor loadings of compliance of safety regulations in the public buildings**

Item	Factor	Variables included in the factor	Factor Loading	Eigen value	Variance explained %	Cumulative variance %
1	Compliance of fires safety management	Means of escape is provided	.709	7.637	34.713	34.713
		Cautious when using naked flames	.671			
		Perimeter vehicle access for emergency vehicles are complied with	.825			
		Cautious switching-off all un-used electrical outlet	.873			
		Fire exits are provided	.883			
		Fire alarm is available	.713			
		Fire hose reel is available				
		Emergency lightning system is provided	.839			
		Avoid overloading of electrical circuits are obeyed	.872			
2	Compliance of emergency communication systems	Physical accessibility to building is provided	.848	7.172	32.599	67.312
		Creation of more ventilation point	.857			
		Fire safety regulations on the provision of signs and notices are adhered to	.769			
		Provision of halon gas system is adhered to	.705			
		Fusible link door is provided	.936			
		Fire hydrant is provided	.747			
		Fire buckets are available	.736			
		Fire Blankets are available	.786			
		Wet riser is available	.776			
3	Compliance of firefighting equipment	Portable Fire Extinguishers are available	.867	1.083	4.922	72.234
		Smoke detectors are provided	.632			
		Sprinkler system is available	.872			
		Heat detector is provided	.778			

Extraction Method: Principal Component Analysis.

Rotation Method: Varimax with Kaiser Normalization

\*a. Rotation converged in 5 iterations

Note. Factor loadings < .30 are suppressed

The compliance of fire safety management factor explains 34.713% of the total variance among the 22 fire safety regulation compliance by occupants of public buildings. The second factor (FII), named compliance of emergency communication

systems, is defined by statements such as avoid overloading of electrical circuits are obeyed, physical accessibility to building is provided, creation of more ventilation point, fire safety regulations on the provision of signs and notices are adhered to, provision of halon gas system is adhered to, fusible link door is provided, and fire hydrant is provided. Compliance of emergency communication system accounted for 32.599% of the total variance among the 22 fire safety regulation. The third factor (FIII), determined by fire safety regulation is named compliance of firefighting equipment (fire buckets are available, fire blankets are available, wet riser is available, portable fire extinguishers are available, smoke detectors are provided, sprinkler system is available, and heat detector is provided). As depicted in Table 2, compliance of firefighting equipment explained about 4.922% of the total variance among the items. On the variance-covariance matrix, all the three extracted factors with an eigenvalue were greater than 1.0.

### Safety performance of public buildings

The safety performance of public buildings in Ashanti and the Greater Accra regions of Ghana were assessed. The mean ( $\bar{X}$ ), and standard deviation (SD) were computed. Table 3 presents the results.

**Table 3: Responses on safety performance of public buildings**

S/N	Safety performance	Mean	Std. Dev.	Decision
1.	Good condition without obvious defects of public buildings	4.20	1.069	Agreed
2.	Non-destruction of public building property	4.10	.943	Agreed
3.	Reduces insurance premium of public buildings	4.00	1.006	Agreed
4.	Employee feels secured of public buildings usage	3.87	1.021	Agreed
5.	Reduction in public building disaster risk	3.72	1.272	Agreed
6.	Increases the prestige attached to the public buildings	3.62	1.272	Agreed
7.	Safety and security of workers on the usage of public buildings	3.54	1.386	Agreed
8.	Minimize property loss of public buildings	3.24	1.329	Agreed
9.	Ensures standardization of public buildings	3.13	1.335	Agreed
10.	Reduces cost in maintenance and purchasing new equipment during fire outbreak	3.12	1.318	Agreed
11.	Continuous running of business in the public buildings	2.73	1.307	Disagreed
12.	Permanent usage of public buildings	2.72	1.299	Disagreed
13.	Increase profit margin generated from the public buildings	2.71	1.375	Disagreed
14.	Increase in the employee performance	2.34	1.445	Disagreed
15.	Increase the goodwill of the public buildings	2.29	1.068	Disagreed
16.	Produces more efficient organizational structure	2.22	1.139	Disagreed

Note:  $X < 3.0$ =Disagreed;  $X > 3.0$ = Agreed

As depicted in Table 3, the respondents agreed that fire safety compliance leads to good condition without obvious defect of public buildings with a scores ( $\bar{x}$ =4.20,  $SD$ =1.069). Moreover, the respondents agreed that fire safety compliance ensures non-destruction of public buildings property with a scores( $\bar{x}$ =4.10,  $SD$ =.943). In addition, a scores ( $\bar{x}$ =4.00,  $SD$ =1.006) the respondents agreed that fire safety compliance reduces insurance premium of public building. Furthermore, the respondents agreed that the fire safety compliance makes employee feels secured of public buildings usage( $\bar{x}$ =3.87,  $SD$ =1.021). Furthermore, the respondents agreed

fire safety compliance reduces public buildings disaster risk with a scores ( $x=3.72$ ,  $SD=1.272$ ). On whether fire safety compliance increases the prestige attached to the public buildings, the respondents agreed to the statement ( $x=3.62$ ,  $SD=1.272$ ).

However, the respondents disagreed to continuous running of business in the public buildings ( $x=2.73$ ,  $SD=1.307$ ), permanent usage of public buildings ( $x=2.72$ ,  $SD=1.299$ ), increase profit margin generated from the public buildings ( $x=2.71$ ,  $SD=1.375$ ), increase in the employee performance ( $x=2.34$ ,  $SD=1.445$ ), increase the goodwill of the public buildings ( $x=2.29$ ,  $SD=1.068$ ), and produces more efficient organizational structure ( $x=2.22$ ,  $SD=1.139$ ) as safety performance of public buildings. These statements failed to meet the predetermined cut-off point of 3.0.

### ***Principal factor analysis on safety performance of public buildings***

Factor analysis was performed on the safety performance of public buildings variables. The Kaiser-Meyer-Olkin (KMO) measure of sampling adequacy was found to be .739. Factor loadings of 16 variables are depicted in Table 4.

Table 4 summarizes the varimax-rotated factor matrix with Kaiser Normalization, which extracts three factors. Variables with loading  $<0.30$  were dropped and items with higher loadings were considered to be important and to have influence on the label selected to present a factor.

Naming of the factors was original contribution of the researcher. The variables; non-destruction of public buildings property, reduces insurance premium of public buildings, employee feels secured of public buildings usage, ensures standardization of public buildings, reduces cost in maintenance and purchasing new equipment during fire outbreak, increase the goodwill of the public buildings, produces more efficient organizational structure, permanent usage of public buildings, and increase in the employee performance belong to the first factor (F1), named reduce of cost of rebuilding and maintenance of public buildings. The reduction of cost of rebuilding and maintenance of public building explained about 19.727% of the total variance among the items. Moreover, good condition without obvious defects of public buildings, reduction in public buildings disaster risk, increases the prestige attached to the public buildings, minimize property loss of public buildings, and increase profit margin generated from the public buildings belongs to the second factor (F2) and are described as ensure good condition of public building.

The ensuring good condition of public building factor explains 17.695% of the total variance among the 16 safety performance of public buildings variables. The third factor (F3) named ensure safety and security of occupants; safety and security of workers on the usage of public buildings, ensures standardization of public buildings, reduces cost in maintenance and purchasing new equipment during fire outbreak, continuous running of business in the public buildings, permanent usage of public buildings, increase the goodwill of the public buildings. Ensuring of safety and security of occupants accounted for 11.267% of the total variance among the 16 safety performance of public buildings.



**Table 4: Factor loadings of overall performance measurement**

Item	Factor	Variables included in the factor	Factor Loading	Eigenvalue	Variance explained %	Cumulative variance %
1	Reduce cost of rebuilding and maintenance of public buildings	Non-destruction of public buildings property	.862	3.156	19.727	19.727
		Reduces insurance premium of public buildings	.920			
		Employee feels secured of public buildings usage	.905			
		Ensures standardization of public buildings	.557			
		Reduces cost in maintenance and purchasing new equipment during fire outbreak	.479			
		Increase the goodwill of the public buildings	.408			
		Produces more efficient organizational structure	.532			
		Permanent usage of public buildings	.663			
		Increase in the employee performance	.130			
		Good condition without obvious defects of public buildings	.493			
2	Ensure good condition of public buildings	Reduction in public buildings disaster risk	.787	2.831	17.693	37.420
		Increases the prestige attached to the public buildings	.824			
		Minimize property loss of public buildings	.853			
		Increase profit margin generated from the public buildings	.712			
		Safety and security of workers on the usage of public buildings	.915			
		Ensures standardization of public buildings	.359			
3	Ensure safety and security of occupants	Reduces cost in maintenance and purchasing new equipment during fire outbreak	.364	2.194	13.711	51.131
		Continuous running of business in the public buildings	.224			
		Permanent usage of public buildings	.524			
		Increase the goodwill of the public buildings	.613			

Extraction Method: Principal Component Analysis.

Rotation Method: Varimax with Kaiser Normalization

\*a. Rotation converged in 5 iterations

Note. Factor loadings < .30 are suppressed

## Relationship between fire safety compliance and safety performance of public buildings

### *Correlation analysis*

Correlation analysis was used to find out the relationship between the compliance of safety regulation and safety performance of public buildings. Table 5 shows the relationship that exists between the variables.

**Table 5: Correlation matrix of fire safety compliance against safety performance**

	Construct	1	2	3	4	5	6
1	Compliance of fires safety management	1					
2	Compliance of emergency communication systems	.706**	1				
3	Compliance of firefighting equipment	.894**	.817**	1			
4	Reduces the cost of rebuilding and maintenance of public building	-.035	.041	.026	1		
5	Ensure good condition of public building	.669**	.695**	.711**	.056	1	
6	Ensures safety and security of occupants	.754**	.945**	.853**	.050	.724**	1

\*\* . Correlation is significant at the 0.01 level (2-tailed).

\* . Correlation is significant at the 0.05 level (2-tailed).

Statistically, the study found a positive significant correlation between compliance of fire safety management and good condition of public buildings ( $r = .669$ ,  $p < 0.001$ ), and safety and security of occupants of public buildings ( $r = .754$ ,  $p < 0.001$ ). The results of Pearson's correlation coefficient further show a positive relationship between compliance of emergency communication system and good condition of public buildings ( $r = .695$ ,  $p < 0.001$ ), and safety and security of occupants of public buildings ( $r = .945$ ,  $p < 0.001$ ). Again, positive significant correlation was found between compliance of firefighting equipment and good condition of public buildings ( $r = .711$ ,  $p < 0.001$ ) and safety and security of occupants ( $r = .853$ ,  $p < 0.001$ ).

### *Regression analysis*

In order to address the relationship between the compliance of safety regulation and safety performance of public building, regression analysis was conducted. The study analysed the variations of safety performance of public building due to compliance of fire safety regulation. The findings are shown in Table 6.

**Table 6: Model summary**

Model	R	R Square	Adjusted R Square	Std. Error of the Estimate
1	.744 <sup>a</sup>	.554	.549	.633

a. Predicators: (Constant), compliance of fires safety management, compliance of emergency communication systems, compliance of firefighting equipment

According to the model summary output, the variables were significantly correlated where R (coefficient of correlation) was a positive correlation of 0.744 indicating that the compliance of fire safety regulation were highly related to safety

performance of public buildings. The identified independent variables (compliance of fires safety management, compliance of emergency communication systems, compliance of firefighting equipment), explains only 55.4% variation in the dependent variable (safety performance of public buildings). Analysis of variance was carried out and the findings are presented in Table 7.

**Table 7: Analysis of variance**

Model		Sum of Squares	df	Mean Square	F	Sig.
1	Regression	153.176	3	51.059	127.293	.000 <sup>b</sup>
	Residual	123.542	308	.401		
	Total	276.718	311			

a. Dependent Variable: safety performance of public building

b. Predictors: (Constant), compliance of fires safety management, compliance of emergency communication systems, compliance of firefighting equipment

The relationship was significant at critical value (0.001) since the reported p-value (0.000<0.01) was less than the critical value. This means that the safety performance of public buildings was significant at 95%. This implies that there is a positive significant relationship between compliance of fire safety regulation and safety performance of public buildings in Ashanti and the Greater Accra regions (F=127.293, df=308, p=000<0.01). The evaluation of a building performance in terms of fire safety is always aimed at assessing its compliance with certain safety standards.

**Table 8: Regression coefficient**

Model		Unstandardized Coefficients		Standardized Coefficients	t	Sig.
		B	Std. Error	Beta		
1	(Constant)	1.218	.153		7.981	.000
	Compliance of fires safety management	.188	.076	.212	2.489	.013
	Compliance of emergency communication systems	.333	.061	.359	5.419	.000
	Compliance of firefighting equipment	.208	.096	.228	2.173	.031

a. Dependent Variable: safety performance of public building

From Table 8, the results indicated that a unit increase in average compliance of fire safety management increases the average safety performance of public buildings by 0.188 ( $\beta=0.188$ ,  $t=2.489$ ,  $p=0.013<0.05$ ). This implies that occupant compliance of fire safety management is a significant predictors of safety performance of public buildings ( $p$ -value < 0.05). The findings as shown on the table reveal that a unit increase in average compliance of emergency communication system positively and significantly increases the average safety performance of public buildings ( $\beta=.333$ ,  $t=5.419$ ,  $p=0.000<0.01$ ). This implies that occupant compliance of emergency communication system influences the safety performance of public buildings. The finding also reveals that a unit increase in average of compliance of firefighting equipment positively and significantly increases the safety performance of public buildings ( $\beta=0.208$ ,  $t=2.173$ ,  $p=$

0.031<0.05). This implies that occupant compliance of firefighting equipment could influence the safety performance of public buildings.

## **DISCUSSION**

The result shows that fire hydrant, sprinkler system, halon gas system, heat detector, emergency lightning system, fire buckets, and fire blankets are not available at most of the public buildings in the Greater Accra and Ashanti regions of Ghana. At the various public buildings, firefighting equipment are either not available or where available they are not functional or that the occupants of the buildings are not even sure of their availability and functionality. This finding aligns with the report by GNFS (2020) which disclosed the citizenry has still not given fire safety protocols the urgency and attention it deserves. The finding explains the observation by Kahwa (2009) that there had been a trend of increasing incidences of fires and their consequences in public institutions in Ghana between 1999 and 2006. This showed that, fire incidences in educational and commercial buildings in Ghana resulted from negligence and non-compliance of fire safety regulation. The finding is also a true reflection with physical observations made by the researchers in some of the buildings visited in the course of the study. Fire hose reel, oftentimes when available are mostly not functional, while most of the passive firefighting equipment like sprinkler system, fire hydrant, risers, fusible link door and halon gas system are mostly not available in public buildings occupied by the respondents. This was also confirmed during the physical observation by the researchers. Apart from portable fire extinguishers and fire alarm systems, all other fire equipment was found to be below average rating of respondents in terms of availability and functionality.

A positive significant relationship was found between compliance of fire safety regulation and safety performance of public buildings in Ashanti and the Greater Accra regions of Ghana. The coefficient of compliance of fire safety regulation was positive and significant, meaning that it was a major variable that determined reduction in the cost of rebuilding and maintenance of public buildings, good condition of public buildings, and safety and security of occupants of public buildings. The results of this study were in agreement with the findings of a study by Taylor (2010). According to Taylor, it is reasonable for owners and managers of buildings to comply with fire safety regulations, because it helps ensure good condition of buildings, safety and security of workers. Windapo and Oladapo (2012) affirmed that compliance of fire safety regulation eliminates or reduces injuries, loss of materials and time, payment of compensation and payments to injured staff when off duty, hence reducing the cost of production and affecting the profit margin of the organisation. As such, to prevent destruction to buildings, reduce the cost of production, improve productivity and maximize profits, many firms seek to improve safety in their organisations and this includes compliance with fire safety regulations (Windapo & Oladapo, 2012). This explains why Nzuve and Lawrence (2012) posit that good condition without obvious defects of public buildings, and prevention of destruction of public buildings often reflect on the level of compliance with fire safety regulations. The finding also supports Idubor and Osiamoje (2013), that organization compliance with fire safety regulation improves safety performance of buildings.

## CONCLUSION AND RECOMMENDATIONS

Fire safety practices is an aspect that has suffered great neglect among designers and users of public buildings, this may be due to uncared attitudes and ignorance on the part of building owner and users. The present study found that the occupants of public buildings in Ashanti and the Greater Accra regions do not comply with safety regulation. At the various public building, firefighting equipment is either not available or where available they are not functional or that the occupant of the buildings is not even sure of their availability and functionality. The study found a positive and significant relationship between compliance with fire safety regulation and safety performance of public buildings in Ashanti and the Greater Accra regions of Ghana. Fire safety practices and awareness is very necessary as it is anonymously said "to be forewarned is to be forearmed" adequate knowledge of fire, cause, prevention and suppression are very important to all building occupants, also provision of adequate firefighting equipment is very important.

The study recommends that building owners should ensure that their buildings are well equipped with active and passive firefighting equipment. Also, training on fire safety, first aid, use of firefighting equipment, and evacuation procedure should be made compulsory for all building occupants and at regular intervals. Government of Ghana should revisit the fire code and resuscitate its administration and implementation, compliance with fire code regulation should be made compulsory for building owners, users, and occupiers of public buildings and any defaulters are brought to book. Also, compliance with the fire code and issuance of fire certificate should be approached right from the inception of the construction and appropriate follow up ensured after completion and throughout the building's life span. It is recommended that Ghana National Fire Service (GNFS) and National Disaster Management Organization (NADMO) should do the proper inspection of public buildings to ensure compliance with fire safety regulation in the country.

## REFERENCES

- Addai E. K, Gabel D., & Krause, U. (2015). Explosion characteristics of three component hybrid mixtures. *Process Safety Environment Protect*, 9(3), 72-81.
- Addai, E. K. Tulashie, S. K., Joe-Steve A., & Yeboah, I. (2016). Trend of Fire Outbreaks in Ghana and ways to prevent these Incidents. *Safety and Health at Work*, 30(3), 1-9
- Aliyu, A., & Abdulrahman, L. I. (2016). Renewable materials to reduce building heat loss: Characterization of date palm wood. *Energy and buildings* 43 (2-3):491-497.
- Anane, S. (2016). Exposure assessment, a preventive process in managing workplace safety and health, challenges in Ghana. *Safety of Science*. 84:210–215.
- Asori, M., Dogbey, E., & Dumedah, G. (2020). Wildfire hazard and Risk modelling in the Northern regions of Ghana using GIS-based Multi-Criteria Decision Making Analysis. *Journal of Environment and Earth Science*, 10(1), 5-11.
- Ayarkwa J., Danso, A. K., & Adinyira, E. (2010). Incidence of domestic fire outbreaks in Ghana: causes and prevention. *Ghana Surveyor*; 4(1):1-13
- Ayarkwa, J., Danso, K. A., & Adinyira, E. (2011). Incidence of Domestic fire outbreaks in three cities in Ghana.

- Economic Times (2020). Types of buildings as categorised by government and how infrastructure development can shape India's future. Retrieved from <https://economictimes.indiatimes.com>. Accessed: May, 18, 2021.
- Engel, R. (2020). Common causes of electrical fires. Retrieved from <https://www.firerescue1.com>. Accessed: May, 18, 2021.
- Gakpe B. K., & Mahama, P. Y. (2014). Reportage of stories on fire outbreaks in Ghana: an analysis of the Daily Graphic and the Chronicle. *New Media Mass Communication* 14;24:1-11.
- Ghana National Fire Service (GNFS) (2018). Ghana National Fire Service Act, 1997. Retrieved from: [http://www.epa.gov.gh/Ghanalex/Acts/GhanaNationalFireService Act,1997](http://www.epa.gov.gh/Ghanalex/Acts/GhanaNationalFireServiceAct,1997). January 6, 2019.
- Ghana National Fire Service Act - 1997 (Act 537). Fire Precaution (Premises) Regulation LI 1724
- Hassan, H. (1999). Fire and Safety Management in Buildings, *The Professional Builders Journal*. June/July. 32-35.
- Idubor, G., & Osiamojie, S. M. (2013). Smoke alarms and prevention of house-fire-related deaths and injuries. *Western journal of medicine* 173 (2):92.
- Karake, P. M., & Kulkarni, G. S. (2013). Fire Safety Assessment for Educational Building in India. *International Journal of Science and Research (IJSR)*, 4 (8), 1-4
- National Building Code of Finland (2011). Fire safety of buildings; Regulations and guidelines. Decree of the Ministry of the Environment on Fire Safety of Buildings.
- Nzuve, S. N. M., & Lawrence, B. A. (2012). The extent of compliance with occupational safety and health regulations at registered workplaces in Nairobi. *International Journal of Business, Humanities and Technology*, Vol. 2 (2) 115-120.
- PAROC (2017). Fire classification. Retrieved [www.paroc.com](http://www.paroc.com). Accessed: 9 July 2019
- Pharmaceutical Society of Ghana (2016). Central Medical Store to be Rebuilt. Retrieved from <http://www.psg.org/news/267632/Central-Medical-Store-to-be-Rebuilt.htm>
- Robinson, F. I. (2014). "Risk Analysis: A Systematic Method for Hazard Identification and Assessment". *Journal of Industrial Pollution Control*. 9(2):88-96.
- Sam-Okyere, M. (2010). Fire Outbreaks: the causes are staring us in the face. Retrieved September 11, 2014: <http://www.modernghana.com/news/467788/50/fire-outbreaks-the-causes-are-stari.html>
- Shittu, S. A. (2007). "Risk Analysis of a Typical Chemical Industry using ORA Procedure". *Journal of Loss Prevention in the Process Industries*. 14:43-59.
- Taylor, D. (2010). "Fire and Innocence," *Texas Observer*, November 27, 2010.
- Tettey, J. (2011). National building guide for lightly loaded structures in disaster prone areas in Ghana. Retrieved from [http://nadmo.gov.gh/images/NADMO documents/2015\\_documents/BUILDING%20GUIDE.pdf](http://nadmo.gov.gh/images/NADMO_documents/2015_documents/BUILDING%20GUIDE.pdf). Accessed: December, 21, 2018
- Windapo, H., & Oladapo, P. (2012). Legislative safeguards needed to protect college students from fire. *Firehouse*: 31(9), 22.



---

# AN INVESTIGATION INTO THE USE OF BUILDING INFORMATION MODELLING AND ITS IMPACT ON CONSTRUCTION PERFORMANCE WITHIN GHANAIAN CONSTRUCTION INDUSTRY

Frederick Kwasi Wirekoh<sup>1</sup> and Humphrey Danso<sup>2</sup>

<sup>1,2</sup>*Department of Construction and Wood Technology Education, Aketen Appiah-Menka University of Skills Training & Entrepreneurial Development, Kumasi-Ghana*

Building Information Modelling (BIM) is a key computer aided technology that can facilitate construction productivity enhancements through the removal of numerous construction inefficiencies. This study investigates the use of BIM and its impact on construction project performance in Ghanaian architecture, engineering and construction industry. A cross-sectional survey design was adopted for the study. Self-administered questionnaires were used for data collection from architects, structural and civil engineers, project managers, quantity surveyors, contractors and general foremen in Greater Accra, Ashanti and Western Regions. Purposive sampling technique was used to elicit information from 300 participants. Data was analysed through the use of multiple response analysis, relative importance index (RII), principal component analysis and descriptively analysis. The results indicated that experts in the construction industry obviously agreed that the use of BIM has a great impact on construction project performance. Increase productivity, improve product quality and create customer value, help in removing barriers and constraints, reduce time of project design and shop drawings, improve communication effectiveness, provide accurate cost estimation and take off materials, reduce conflicts and number of claims, reduce defects in the construction phase, increase collaboration in project design were considered by the respondents as the most important factors for project performance improvement. It is recommended that experts and stakeholders should encourage the use of BIM technology in Ghanaian construction industry to improve construction project performance to meet customer satisfaction and also boost the infrastructural development.

Keywords: building information modelling (BIM), construction performance, Ghana

## INTRODUCTION

Information technology (IT) is one of the promising tools which have been constantly deemed as a solution to save construction projects. Among those,

---

<sup>1</sup> profred9@hotmail.com

<sup>2</sup> hdanso@aamusted.edu.gh

computer-aided design (CAD) software applications have been playing the leading role for more than three decades in the construction industry (CI). BIM-supported software applications are the new generation of CAD software applications (Parvan, 2012). Building Information Model (BIM) is known as a shared digital representation of the physical and functional characteristics of the facility in the Architectural, Engineering and Construction (AEC) industry. The basic premise of BIM is to improve collaboration and interoperability among the stakeholders of the facility during its lifecycle. The 3D visualization is the basic essential feature of BIM. However, BIM is not just a 3D CAD. It is more than the elaborated 3D renderings. Also, it is more than delivering the project documentation in the electronic version. It is about information use, reuse, and exchange, of which the digital format is just one part (Parvan, 2012).

General Services Administration (GSA, 2007) BIM guide defines BIM as the development and use of a multi-faceted computer software data model not to only document a building design, but to simulate the construction and operation of a new capital facility or a recapitalized (modernized) facility. BIM is the process of generating, storing, managing, exchanging, and sharing building information in an interoperable and reusable way (Vanlande, Nicolle & Cruz, 2008). BIM is a revolutionary technology and process that has quickly transformed the way buildings are conceived, designed, constructed and operated (Hardin, 2009). BIM can also be referred to as a computer-integrated project due to its process and technology application in project delivery (Azhar et al., 2012).

The building industry is under great pressure to provide value for money, sustainable infrastructure, visual and analytical checks to enable better code compliance and this has boosted the implementation of BIM technology (Mihindu & Arayici, 2008). According to Ahadzie and Amoah-Mensah (2010) and Laryea (2010), the Ghanaian construction industry faces challenges that include inadequacy of finance and credit services for contractors, design constraints and variation of works, poor preparation and supervision as well as low computerization. A further challenge of construction management is the poor estimation of project cost (Agele, 2012; cited in Akwaah, 2015). The industry is changing and adopting new ways of working which include an increased digitalization and implementation of BIM (Crotty, 2013, Bryde et al. 2013), supply chain integration (Briscoe & Dainty, 2005) and productivity enhancement (Dubois & Gadde, 2002). Stakeholders in the construction industry use variety of scheduling methods, study as well as its application; however, they are not sufficiently competent to fulfil the need of building parties. Thus, parties in AEC industries make use of scheduling methods such as Critical Path Method (CPM) and Program Evaluation and Review Technique (PERT), Gantt Charts, Task List, Simulation and others but yet have short comings in project delivery. There exists a huge discrepancy among the implementation as well as plan (Allen & Smallwood, 2008).

Studies conducted on BIM in Ghana include Akwaah (2015), on the guideline for building the capacity of contractors for adoption and implementation of BIM in Ghana. Nani (2015) studied the guidelines for capacity building of construction firms for BIM adoption in Ghana. Acquah, Eyiah and Oteng (2018) investigated the acceptance of BIM, which was a survey of professionals in the construction industry in Ghana. Akwaah and Nani (2015) investigated the fundamental requirements for



the adoption and implementation BIM of by contractors, the state of BIM implementation, the relevance of BIM implementation, and the challenges of BIM implementation to construction firms in Ghana. Armah (2015) considered the areas of implementing BIM in the construction industry, the benefits that come with the adoption of BIM, and the barriers to BIM implementation in the construction industry in Ghana.

All the above researches on BIM in Ghana did not consider the use of building information modelling and its impact on construction project performance. This gap necessitated the need to conduct a study on the use of building information modelling and its impact on construction performance in the Ghanaian construction industry since that aspect is lacking in BIM literature in Ghana. The purpose of the study is to investigate the use of building information modelling and its impact on construction performance within the Ghanaian construction industry.

## LITERATURE REVIEW

### **Building Information Modelling (BIM)**

Alvarez-Romero (2014), described Building Information Modelling (BIM) as one of the most promising technologies for the Architecture, Engineering, and Construction industries. Building information models encapsulate and represent the three-dimensional geometry of building objects and the corresponding attributes of a physical facility. By its very nature, it promotes collaboration from design and construction participants around the digital model of a facility. The core of BIM is the building geometry, but also is a structured information base of non-graphical data that provides detailed information about the identity of building components and their properties, for example a wall element in a model exists as a wall and is no longer represented by a set of drawn lines (Alvarez-Romero, 2014). The National Building Information Model Standards (NBIMS) vision for BIM is an improved planning, design, construction, operation, and maintenance process using a standardized machine-readable information model for each facility, new or old, which contains all appropriate information created or gathered about that facility in a format useable by throughout its lifecycle (NIBS 2008). This definition implies a collaborative and integrated approach (see Figure 1). BIM is a tool used by designers, engineers, and contractors to present the graphics and database of a construction project to enhance the communication between all project stockholders (Krygiel & Nies, 2008).

Katez and Gerald (2010) define BIM as a "multi-faceted computer software data model to not only document a building design but to simulate the construction and operation of a new capital facility or a recapitalized facility" (p. 26). Meanwhile, Krygiel and Nies (2008) define BIM as "the creation and use of coordinated, consistent, computable information about a building project in design-parametric information used for design decision making, production of high-quality construction documents, prediction of building performance, cost estimating, and construction planning" (p. 27). The BIM model presents the actual building construction and assemblies and two-dimensional drawings (Azhar, 2011).

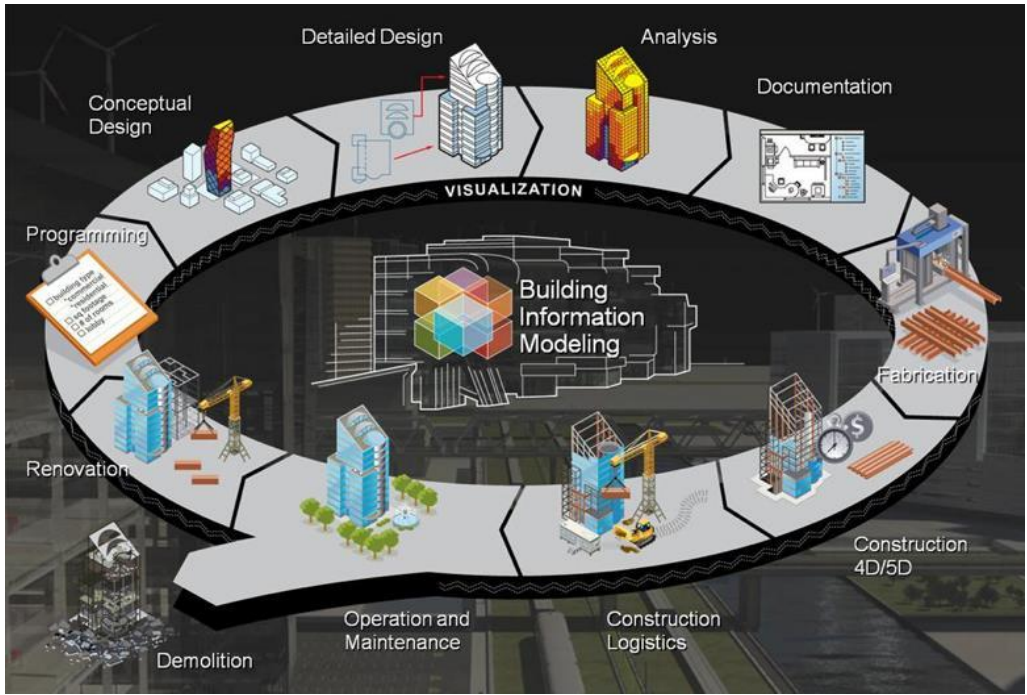

Figure 1: Collaborative and Integrated view of BIM through the project lifecycle, Image Source: Alvarez-Romero (2014).

Figure 2 shows a 3D external model for a commercial building design in Iraq presenting the final design concept and the finishing materials of the building.



Figure 2: A 3D BIM model for a commercial building design in Babylon city- Iraq Source: Hussein and Zaid (2016).

BIM has created a new development revolution in the design and construction industry. It is causing a major paradigm shift in the Architectural, Engineering and construction industry while creating wider and newer opportunities for young professionals (Uddin & Atul, 2014). While this creates a positive drive and focuses on this industry, it is also important to fully understand what BIM encompasses. BIM is expansive (Turk, 2016). Turk’s study discusses the structural, functional and behavioural attributes of BIM which indicate its complex nature. Roles such as BIM managers, BIM coordinators and BIM specialists are becoming increasingly popular

and sought after for BIM assisted construction projects. The complex nature of BIM can be seen in a study that identified the motivations for adopting BIM were multi-dimensional (Dongping, 2016). BIM consists of several dimensions, 3D BIM models, 4D BIM adds time-related information to 3D to enable detailed scheduling of the construction process. 5D BIM adds costs to BIM components to assist the calculation of total project costs. 6D BIM includes lifecycle properties to enable optimised asset management. This makes the entire process complex in nature

Therefore, a limited understanding of its capability and resultant impacts would mean that the industry would not be maximizing the benefits of BIM and in some instances could harm the progress and expansion of BIM.

The pursuit to better understand and define BIM has prompted studies to establish a standard for effectively measuring and understanding Building Information Modelling Maturity (BIMM). Chen (2013) explores BIMM and investigated the indicators and related factors that would capture a more comprehensive understanding of BIM as it relates to its maturity (Chen, Hazar Mark, & Mihaela, 2016). The study by Chen proposes that BIMM can be grouped under Technology, Information, Process and People. Succar identifies the factors proposed by Chen but also includes Policy as a factor of BIM (Succar, Sher, & Williams, 2012). Therefore, the literature review indicated that the comprehensiveness of BIMM can be measured through Information, Technology, Process, People and Policy Management. Maturity is synonymous for effectiveness and performance as the Building Information Modelling is composed of dimensions such as Technology, information, process and people. The application of software's, information delivery methods, Process & Technology Innovation as well as competency profile of teams in the AEC industries determines the output of work.

Chen (2013), presented a table listing the dimensions/factors and grouped indicators under the relevant dimensions as seen in Table 1. Collaboration among project participants is important for aspects of Productivity. However, it seems that software interoperability has been a significant issue in the application of BIM (Bynum, 2013). Project delivery is a team work which includes the client's team, construction team, statutory personals and designers. BIM usage brings on board all the various stakeholders or persons together and as such, each of the team performs a unique function to realize an effective delivery of project amounting to its general performance. A critical success factor for the successful implementation of BIM is the willingness of participants to share information (Won et al, 2013). BIM can be used as an effective platform for collaboration by changing the way construction is performed and documented (James & Meadati, 2008). For collaboration in practice, a case study showed that there was an expectation for participants on BIM projects to drive collaboration, as opposed to having an expectation of a collaborative organizational structure (Dossick & Neff, 2010). These studies refer to BIM being a platform for collaboration and as a result a means of achieving productivity. However, the studies indicate a necessity to improve elements such as software interoperability of BIM, while also improving leadership from the participants to share information and collaborate.

**Table 1: BIMM Dimensions and Indicators**

BIMM Dimension	BIMM Indicator
Technology (Chen, 2013; Jung and Joo, 2011; Succar 2010)	Software Applications Interoperability Hardware Equipment Hardware Upgrade Information Delivery Method (IDM) Information Assurance Data Richness
Information (Chen et al. 2014; CIC 2011; NIBS 2007)	Real-Time Data Information Accuracy Graphics Geospatial Capability Work Flow Documentation and Modeling Standards (DMS)
Process (Giel & Issa 2013; Gu & London 2010; Mom et al. 2011)	Process & Tech Innovation (PTI) Strategic Planning Lifecycle Process Change Management Risk Management Standard Operating Process (SOP) Quality Control
People (Chen, 2013; Computer Integrated Construction, 2013; Gu & London, 2010; Gu, Singh, & London, 2014)	Senior Leadership Role Reward System Competency Profile Training Delivery Method (TDM)

Source: Chen (2013)

### Understanding BIM

From a technology perspective, a building information model is a project simulation consisting of the 3D models of the project components with links to all the required information connected with the project planning, design, construction or operation as depicted in Figure 3 (Kymmell, 2008). The BIM technology hailed from the object-oriented parametric modelling technique (Azhar et al., 2008). The term "parametric" describes a process by which an element is modified and an adjacent element or assembly (e.g. a door attached to a wall) is automatically adjusted to maintain a previously established relationship (Stine, 2011).

### BIM as technology

From a technology perspective, a building information model is a project simulation consisting of the 3D models of the project components with links to all the required information connected with the project planning, design, construction or operation as depicted (Kymmell, 2008). The BIM technology hailed from the object-oriented parametric modelling technique (Azhar et al., 2008). The term "parametric" describes a process by which an element is modified and an adjacent element or assembly (e.g. a door attached to a wall) is automatically adjusted to maintain a previously established relationship (Stine, 2011).

### **BIM as a process**

BIM can be viewed as a virtual process that encompasses all aspects, disciplines, and systems of a facility within a single, virtual model, allowing all team members (Owners, architects, engineers, contractors, subcontractors and suppliers) to collaborate more accurately and efficiently than traditional processes. As the model is being created, team members are constantly refining and adjusting their portions according to project specifications and design changes to ensure the model is as accurate as possible before the project physically breaks ground (Carmona & Irwin, 2007).

### **BIM as people**

Competencies may be expressed as “behaviour that an individual need to demonstrate”, or they may be expressed as “minimum standards of performance”. BIM competency represents the ability of users to fulfil all the important areas of an effective BIM implementation to deliver value and achieve the expected BIM product/service. BIM implementation process can produce valuable benefits to BIM users by having the ability to introduce and implement changes effectively (Giel and Issa, 2013c; Nepal et al., 2014; Succar, 2010a). The skills, knowledge and behaviour of people leads to successful performance. These skills, knowledge and behaviour are required to deliver certain activities for successful performance.

## **RESEARCH METHODOLOGY**

A cross-sectional survey was employed for the research design as it permitted the researchers to study the participants once and therefore not necessitating follow-ups (Shuttleworth, 2010). In turn, this design was used to determine the key drivers for acceptance and implementation of BIM in the construction industries in Ghana, explore the most important factors of improvement in performance on construction projects as a result of adoption and implementation of BIM in the construction industry in Ghana. Creswell and Plano (2011) defined the research population as a large well-defined collection of individuals having similar features. The target population for this study consisted of experienced professionals from the architectural consultancy firms, quantity surveying firms, and structural engineering firms operating within the Kumasi, Accra, and Sekondi-Takoradi metropolises in Ghana.

The sampling frame used for the study was well-established firms registered by the Architectural Registration Council-Ghana, Ghana Institute of Surveyors and Ghana Chamber of Construction. Bryman (2004) opined that sampling techniques tell us how part of the population used in data collected is carefully chosen. The study, therefore, employed purposive sampling to select the firms from the sampling frame as well as the respondents engaged in the study. This technique was chosen specifically because the number of construction projects who had adopted BIM technology greatly overshadowed the number of projects not into this technology, so it facilitated the ease in reaching such firms. Again, this technique ensured participants selection was based on the participant’s organization’s knowledge on BIM (Saunders et al, 2012). In effect, the survey sample consisted of professionals such as architects, engineers, quantity surveyors, contractors and general foremen drawn from 300 participants sampled from the study population.

A close-ended questionnaire was used for collecting data. This is essentially because this tool has the track record as the most reliable technique that helps collect important and valid data (Easterby-Smith et al., 2002). In the design, the questionnaire was supported by literature and thereafter categorized into five main broad headings. The process equally permitted respondents to either rate responses on a seven-point Likert scale and also make multiple choices when it was necessitated. The first part constituted the demographic characteristics of the respondents. The second part was composed of determining the key drivers for acceptance and implementation of BIM in the construction industries in Ghana. Exploring the most important factors of improvement in performance on construction projects as a result of adoption and implementation of BIM in the construction industry in Ghana made the third part as the fourth part highlighted on measuring the relevance of BIM maturity in the Ghanaian construction industry. The fifth and final part focused on determining the various softwares available for BIM essential.

Conca et al. (2004) contended that validity explains the extent to which a test item or an instrument measures what it is purposed to measure. To ensure that the instrument captured all the relevant areas of using BIM technology and the whole proposed survey instrument was well worded and understood; thus, content validity, the questionnaire was sent to two lecturers well versed in BIM technology to check the comprehensiveness of the items under each construct. This helped to improve the content, thereby eliminating ambiguity and ensuring its ease of understanding. To maximize the reliability of the questionnaire, the items generated were pretested on a sample of 20 professionals sharing similar characteristics as the study sample and also in the construction industry at Obuasi Municipal. Reliability refers to the extent to which an instrument measures the same way each time it is used under the same conditions with the same subjects (Naoum, 2007). This sample is consistent with a study by Patton (2002) that suggests that the sample size for a pilot study should be at least 20 respondents. This pre-test aimed to ensure that quantitative measurements corresponded with expected results from interaction with construction consultants. The Cronbach's alpha values of the measurement used met the threshold of 0.7 (Hair et al., 2003; Pallant, 2007) as shown in Table 2.

**Table 2: Reliability Analysis**

Objective	Cronbach's Alpha	No. of variables
Key drivers for acceptance and implementation of BIM in the construction industries in Ghana.	0.878	36
Most important factors of improvement in performance on construction projects.	0.821	13
Measuring the relevance of BIM maturity in the Ghanaian construction industry.	0.871	28
Various software's available for BIM essential for the Ghanaian Architectural, Engineering and Construction (AEC) companies.	0.846	23

The questionnaire was self-administered over a period of about six months in the towns of Kumasi, Accra and Sunyani respectively to the targeted respondents to seek the necessary information in determining the key drivers for acceptance and

implementation of BIM in the construction industries in Ghana. This was preceded by previewing respondents on the necessary arrangements regarding the date, time and place where applicable. Respondents were also informed about the confidentiality of their responses. The quantitative data collected from the field survey through the use of closed-ended questionnaire items were analysed on the Statistical Package for Social Sciences (SPSS) version 25 and Microsoft excel software.

## RESULTS AND DISCUSSION

Descriptive statistics were used to analyse the data subsequently. 214 well-answered questionnaire items were received from a total of 300 items self-administered. This thus approximates the response rate to about 71%.

### **Key drivers for acceptance and implementation of BIM in the construction industries in Ghana.**

Aimed at determining the key drivers for acceptance and implementation of BIM in the construction industry, the respondent's views were subjected to multiple response analysis and ranked subsequently. This was established based on the fact that respondents were presented with items that demanded more than a single response and had the option to select any that they deemed appropriate. The items were tabulated as a dichotomy group at a value of 1 (Yes), a threshold set as the selected item of preference with value 2 (No) as otherwise. The number of "Yes" responses were only tabulated and ranked consequently against the "No" responses from the participants. Again, the key drivers as stated earlier in the objective explained the need and urge as well as the benefits accrued in the use of BIM in the construction industry. They were classified in terms of their advantages, stakeholder's involvement, capabilities and functions and types of buildings affected as shown in Table 3.

In dealing with a data set that offers respondents the liberty to select more than a response at the same time, multiple response analyses stand significant (Simon, 2013). In this respect, the technique was used in determining the key drivers for acceptance and implementation of BIM in the construction industries in Ghana. Six main drivers were identified in this effect. These are; capability and function to create drawings, the involvement of architect/engineers as stakeholders, advantage gained as a result of enhanced productivity, capability and function in providing quality take-off, the involvement of construction managers as stakeholders and its usage in commercial building projects. The capability and function to create drawings came up as a key driver in determining the key drivers for acceptance and implementation of BIM in the construction industries in Ghana. According to Azhar (2011), building proposals can be rigorously analysed, simulations performed quickly, and performance benchmarked, enabling improved and innovative solutions to generate a better design.

Inevitably, stakeholders like architects as well as engineers form a core component in determining the key drivers for acceptance and implementation of BIM in the construction industries in Ghana. This assessment was clarified by Azhar et al, (2012), who claimed that the project architects and engineers can take advantage of BIM in schematic and detailed design; and construction detailing phases.

**Table 3: Key drivers for the acceptance and implementation of BIM in the construction industries in Ghana.**

Drivers	Responses		Ranking by category	Overall ranking
	N	Percent		
<b>Advantages</b>				
Enhance productivity	167	30.5%	1	3
Competitive Advantage	140	25.6%	2	8
Exploring and adopting new trends	91	16.6%	3	14
Required by owners or contracts	75	13.7%	4	19
Success stories of others using BIM	74	13.5%	5	20
Total	547	100.0%		
<b>Stakeholders</b>				
Architect/Engineers	183	35.9%	1	2
Construction Managers	155	30.4%	2	5
General Contractors	77	15.1%	3	17
Owner/Developers	43	8.4%	4	25
Consultants	31	6.1%	5	28
Subcontractors	18	3.5%	6	33
Software Vendors	3	0.6%	7	36
Total	510	100.0%		
<b>Capabilities and Functions</b>				
Create drawings	191	15.9%	1	1
Quantity Take-off	159	13.2%	2	4
Site Planning	120	10.0%	3	9
Clash Detection	119	9.9%	4	10
Scheduling and sequencing	83	6.9%	5	15
Costing and Budgeting	80	6.7%	6	16
Improve project controls	74	6.2%	7	20
Communication	69	5.7%	8	21
Facility management	55	4.6%	9	22
Facilitate decision making	48	4.0%	10	23
Equipment management	46	3.8%	11	24
Waste management	41	3.4%	12	26
Labour resource allocations	35	2.9%	13	27
Collaboration with stakeholders	30	2.5%	14	30
Energy analysis	21	1.7%	15	31
Code compliance	19	1.6%	16	32
Virtual meeting capabilities	11	0.9%	17	34
Total	1201	100.0%		
<b>Types of Building Projects</b>				
Commercial	153	22.3%	1	6
Industrial	148	21.6%	2	7
Residential	118	17.2%	3	11
Educational	93	13.6%	4	12
Institutional	93	13.6%	5	12
Healthcare	77	11.2%	6	17
Transportation	4	0.6%	7	35
Total	686	100.0%		



The construction industry in developed countries is experiencing a major move from the traditional methods of intensive manual Labour towards the utilization of automation that has been made possible through the use of information technology. This trend results in enhanced construction efficiency leading to improved productivity in terms of reduction in wastage, errors, and rework Nath et al. (2015). Provision of quantity take-off as a function and capability of BIM greatly impacts the essence for the acceptance and implementation of BIM in the construction industries in Ghana. Efficient and accurate quantity take-off and cost estimation are pivotal to a project's success (Staub-French, 2003). Aram et al. (2014) emphasized the conditions for successful BIM use in ensuring quality take-off.

The involvement of construction managers as stakeholders forms a major element as a key driver for the acceptance and implementation of BIM in the construction industries in Ghana. Construction managers or general contractors can use BIM to extract quantities of work to prepare cost estimates (Hergunsel, 2011). Complex construction projects require inter-organizational associations (Maurer, 2010). To ensure success in inter-organizational project ventures, trust between the different project partners is acknowledged as a key success factor (Kadefors, 2004; Maurer, 2010). Because of the nature of work in these inter-organizational ventures, there is a well-recognized need for better integration, cooperation, and coordination of construction project teams (Cicmil & Marshall, 2005, cited in Maunula, 2008).

#### **Most important factors of improvement in performance on construction projects as a result of the adoption and implementation of BIM in the construction industry in Ghana.**

In exploring the level of improvement in performance on construction projects as a result of adoption and implementation of BIM in the Ghanaian construction industry, opinions of respondents were analysed using the Relative Importance Index (RII) and subsequently ranked according to their relative importance. This was based on a seven-point Likert scale from strongly important (=7) to strongly unimportant (=1). According to Akadiri (2011), the criticality of RII is defined as follows; strongly unimportant ( $\geq 0.14$ ), very unimportant (0.15 – 0.29), unimportant (0.30 – 0.44), moderately important (0.45 – 0.59), important (0.60 – 0.74), very important (0.75 – 0.89) and strongly important ( $\geq 0.90$ ). Data obtained from respondents therefore were used to calculate the importance of each level of improvement in performance as the basis of the ranking (Table 5). This may be calculated using the formula;

$$RII = \sum \frac{W}{AN}$$

Where RII (Relative index) is used for ranking indicators (degree of importance), W is the weight given to each item by respondents on a scale of one to seven with one implying the least and seven the highest, A is the highest weight (7 in our case) and N is the number of respondents (Akadiri 2011). Table 4 displays the Relative Importance Index (RII) of the level of improvement in performance on construction projects as a result of adoption and implementation of BIM in the Ghanaian construction industry with their associate rankings concerning their mean values. The threshold for the key levels of performance improvement was set at a range of 0.75 – 0.89 and any level below this range was not deemed prime. It was evident

per the criticality of the RII that ten levels of performance improvement (falling within the range 0.75 – 0.89) were identified as “very important” which are interpreted as key levels regarding the level of improvement in performance on construction projects as a result of adoption and implementation of BIM in the Ghanaian construction industry. These levels with their corresponding RII accordingly are; increases productivity (0.81), improves product quality and creates customer value (0.81), helps in removing barriers and constraints (0.80), reduces conflicts and number of claims (0.79), reduces the time of project design and shop drawings (0.79), improves communication effectiveness (0.79), provides accurate cost estimation and take off materials (0.77), reduces conflicts and number of claims (0.77), reduces defects in the construction phase (0.76) and increases collaboration in project design (0.75).

**Table 4: Level of improvement in performance of construction projects as a result of adopting and implementation of BIM**

Level of improvement in performance	RESPONSES (RANKING)							TOTAL	ΣW	MEAN	RII	DESCRIPTION
	1	2	3	4	5	6	7					
Increases productivity	2	0	12	15	50	79	56	214	1214	5.67	0.81	Very important
Improves product quality and creates customer value	0	1	1	20	80	61	51	214	1208	5.64	0.81	Very important
Helps in removing barriers and constraints	1	2	1	24	67	80	39	214	1192	5.57	0.80	Very important
Reduces the time of project design and shop drawings	2	1	0	23	69	73	44	214	1187	5.55	0.79	Very important
Reduces the time of project design and shop drawings	0	1	0	19	87	76	31	214	1186	5.54	0.79	Very important
Improves communication effectiveness	0	1	14	31	56	54	58	214	1178	5.50	0.79	Very important
Provides accurate cost estimation and take off materials	0	0	1	33	87	67	26	214	1154	5.39	0.77	Very important
Reduces conflicts and number of claims	1	1	1	16	112	61	22	214	1150	5.37	0.77	Very important
Reduces defects in the construction phase	2	3	1	52	38	100	18	214	1135	5.30	0.76	Very important
Increases collaboration in project design	3	1	0	62	41	77	30	214	1130	5.28	0.75	Very important
Reduces uncertainty inherent in the construction phase	1	15	2	27	84	78	7	214	1082	5.06	0.72	Important
Generates and evaluates alternative construction plans	1	1	26	43	69	44	30	214	1072	5.01	0.72	Important
Aids in just in time delivery of materials and parts	0	1	8	57	96	41	11	214	1057	4.94	0.71	Important

An increase in productivity came up as an important factor in the improvement in performance on construction projects as a result of the adoption and implementation of BIM in the construction industry of Ghana. It is perceived to have the potential to significantly change and improve performance and documentation in the AEC industry by reducing inefficiencies, enhancing productivity, and increasing collaboration and communication (Campbell 2007;

Goedert & Meadati 2008). Improvement of product quality and creation of customer value emerged also as one of the important factors in performance on construction projects as a result of adoption and implementation of BIM. This is advocated by Jylhä and Junnila (2012) who claim that customers are the nursing companies and their nursing staff; special focus is given to the value potentials that BIM, as well as improved environmental performance, might offer to the customers. From this perspective, it could be said that, to improve product quality and customer value by using processes and systems which aim to fulfil the customer's requirements, enhance customer satisfaction, monitor against applicable quality standards have a great impact on the performance on a construction project.

Another factor obtained is the improvement in product quality and creating of customer value. Czmocho and Pełkala (2014) attested that the construction process enforces the final and accurate decision to be taken. They emphasized further that the BIM model requires accuracy in modelling from the very beginning and that strict standards and rules have to be set within the team to work according to BIM standards as this affects the whole designing teamwork and its efficiency. BIM technology requires the members of the design team to abandon the individual working schemes, so characteristic for each person and specific for discipline or design office.

Reduction of time of project design and shop drawings found itself among the most important factors geared towards improvement in performance on construction projects as a result of adoption and implementation of BIM. Azhar (2011) postulates that BIM can do faster drafting without compromising quality. Linderoth (2010) maintains that the result of using BIM is improved project coordination, minimised errors, as well as reduced delays and conflicts, which could lead to a potential saving in construction cost.

#### **Measuring the relevance of BIM maturity in the Ghanaian construction industry.**

To ascertain the suitability of the data for factor analysis, the Kaiser-Meyer-Olkin Measure of Sampling Adequacy (KMO) and a Bartlett's Test of Sphericity were performed (Table 5). As a rule of thumb, a KMO value of 0.5 or higher necessitates the need to proceed with factor analysis. Therefore, obtaining (Chi-square = 6434.809, df = 231,  $p < 0.000$ ) signifies that it is worth continuing with factor analysis as there is a relationship to investigate.

**Table 5: KMO and Bartlett's test**

KMO and Bartlett's Test		
Kaiser-Meyer-Olkin Measure of Sampling Adequacy.		0.856
	Approx. Chi-Square	6434.809
Bartlett's Test of Sphericity	df	231
	Sig.	0.000

To better appreciate the opinions of respondents in measuring the relevance of BIM maturity in the Ghanaian construction industry, their views were subjected to factor analysis (Table 6). In effect, five main factors came up regarding the precepts underlying the use of this statistical tool. Again, an accumulated value of about

80% emanating from five factors met the criteria of explaining variance of 5%. Further, these five had considerable theoretical backing thus making them interpretable. However, two factors fell outside the scope of this bracket and were eliminated eventually. Concerning their variance explained, their percentages were 53.625%, 15.409%, 6.281% and 5.266% and subsequently ascribed to component 1, component 2, component 3 and component 4 respectively (Table 6).

**Table 6: Total Variance explained**

Component	Extraction Sums of Squared Loadings			Rotation Sums of Squared Loadings		
	Total	% of Variance	Cumulative %	Total	% of Variance	Cumulative %
1	11.797	53.625	53.625	6.262	28.466	28.466
2	3.390	15.409	69.033	5.266	23.937	52.403
3	1.382	6.281	75.315	3.555	16.160	68.563
4	1.163	5.285	80.600	2.648	12.036	80.600

Extraction Method: Principal Component Analysis

Varimax rotation method was used to obtain the factor loadings with their corresponding components in measuring the relevance of BIM maturity in the Ghanaian construction industry (Table 7).

**Table 7: The relevance of BIM maturity in the Ghanaian construction industry**

Relevance	Component			
	1	2	3	4
Interoperability			<b>0.847</b>	
Software Applications			<b>0.697</b>	
Hardware Equipment			<b>0.693</b>	
Information delivery method			<b>0.578</b>	
Information Accuracy	<b>0.874</b>			
Graphics	<b>0.865</b>			
Real-time Data	<b>0.834</b>			
Senior Leadership	<b>0.790</b>			
Process and Technology Innovation	<b>0.780</b>			
Data Richness	<b>0.700</b>			
Information Assurance	<b>0.689</b>			
Strategic Planning	<b>0.688</b>			
Geo-spatial Capability	<b>0.660</b>			
Specification		<b>0.904</b>		
Quality Control		<b>0.889</b>		
Documentation and Modeling Standards		<b>0.811</b>		
Standard Operating Process		<b>0.801</b>		
Work Flow		<b>0.765</b>		
Life Cycle Process		<b>0.737</b>		
Training Program				<b>0.844</b>
Competency Profile				<b>0.777</b>
Training Delivery Method				<b>0.771</b>

Extraction Method: Principal Component Analysis. Rotation Method: Varimax with Kaiser

***Component one: information related factors***

The principal component explained 53.625 % of the total variance with nine factors loading onto it. These factors were; information accuracy, graphics, real-time data, senior leadership, process and technology innovation, data richness, information assurance, strategic planning and geo-spatial capability. According to Eastman et al. 2008, BIM provides information on the ability to evaluate the impact of design changes on construction in a visual manner that is not possible with traditional 2D drawings. Regarding information accuracy, they reiterated further that automated quantity take-off which is linked to the BIM model is more accurate as there are fewer chances of human error; hence, it improves flow by reducing variability. Making information from the BIM especially with the increasing complexity of projects denotes such an improvement beneficial to better control its related complexity issues (Hamdi et al., 2012). Upon the submissions churned out, information related factors are very essential as it prevents doubts, clients and other parties in the Architecture, Construction, Engineering industry rely on requisite information in decision making on projects.

***Component two: process-related factors***

Process related factors had their principal component explaining 15.409 % of the total variance with six factors loading onto it. These included, specification, quality control, documentation and modeling standards, standard operating process, work flow and life cycle process. Pas (2013) hints that and BIM defines how the information modelling aspects of a project will be carried out and clarifies roles and their responsibilities, standards to be applied and procedures to be followed. Giel et al. (2013) attested that, in terms of the BIM specification process, it has specific metrics well defined and serve industry-specific assessment purposes. Quality control, an inevitable process in BIM was clearly explained by Aranda-Mena et al. (2009) who advocates that with building information modelling implementation, quality control ensures that the activities conducted, the mechanisms or techniques used for a project meet the requirements for the product or service are used.

***Component three: Technology-Related Factors***

The principal component defined 6.281 % of the total variance as four factors loaded onto it. The factors were interoperability, software applications, hardware equipment and information delivery method. NIBS (2007) advanced that BIM serves as an eminent technology with its interoperability properties. Expanding further, they explained that software interoperability is seamless data exchange among diverse applications which each may have its internal data structure. Data usage, storage and exchange are well defined within organisations and project teams therefore signifying that interoperable data exchanges are defined and prioritized (Succar, 2010). This in effect affirms that technology field BIM representing the availability, accessibility and affordability of hardware, software and network systems; also, the availability, usability, connectivity and openness of information systems have an impact on the construction project performance.

***Component four: People Related Factors***

People related factors under this principle component explained 5.285 % of the total variance. Three main factors were loaded onto it which were, training program, competency profile and training delivery method. Gu and London (2010)

suggested that, in reaching the level of BIM maturity to better understand and facilitate its adoption in the AEC industry, training should be organized for its users 'overtime. They directed that this training should be dedicated to the use of BIM software tools and the workflows associated with them to be competent in its usage in project delivery. In defining this competency involved through training of the people concerned Dakhil et al. (2019).

#### 4.4 Various software available for BIM essential for the Ghanaian AEC companies

Pursuance to determining the various software's available for BIM essential for the Ghanaian AEC companies, respondent's views were descriptively examined. The outcome of the analysis was based on the precept that mean values of ( $\geq 3.5$ ) were tagged as "Most available", those within the range (3 – 3.49) as "Available", so as those within (2.5 – 2.99) as "Somewhat available" and those falling under ( $\leq 2.0$ ) also classified as "Rarely available (Table 8).

**Table 8: Software's available for BIM essential**

Software's	Mean	SD	Description
Revit Architectural	4.02	1.138	Most available
AutoCAD Architectural	3.88	1.293	Most available
SketchUp	3.81	1.028	Most available
ArchiCAD	3.72	1.153	Most available
AutoCAD Civil 3D	3.52	1.244	Most available
AutoCAD	3.52	1.244	Most available
AutoCAD Design Suite Premium	3.36	1.146	Available
Bentley Systems	3.23	1.127	Available
Revit Structure	3.21	0.722	Available
ARCHline	3.18	0.988	Available
Revit MEP	3.18	1.099	Available
Chief Architect	3.11	1.445	Available
Edificius 3D Architectural	3.04	0.978	Available
3D Ultimate	3.00	1.179	Available
Tekla	2.92	1.221	Somewhat available
Autodesk Navisworks	2.91	1.600	Somewhat available
AutoCAD MEP	2.91	1.436	Somewhat available
Vector Works	2.78	1.246	Somewhat available
Autodesk Navisworks	2.64	1.149	Somewhat available
Twinmotion	2.53	1.741	Somewhat available
Lumion	2.12	1.252	Rarely available

With over twenty variables opened to participant's opinion specifically on deducing the various software's available for BIM essential for the Ghanaian Architectural, Engineering and Construction (AEC) companies, six of these software's came up as the most available softwares. Interesting, Revit architecture emerged as the most available software for BIM essential for the Ghanaian AEC companies. Revit architecture software is used used for 3D architectural modelling and parametric design (Reinhardt, 2009). Guan-Pei, (2010) accentuated that, Revit architecture assumes this enormous patronage because it contains a set of tools, techniques and concepts that allow realizing the BIM approach toward general construction design. AutoCAD architecture similarly surfaced as one of the most available software for BIM essential. Confirming this assertion is AutoCAD (2009), which reckoned that AutoCAD Architecture is the version of AutoCAD software for architects. Drafting and documentation are much more efficient with the software's

intuitive environment and purpose-built tools for architects. Another significant software that fell within the bracket of the most available software for BIM essential was SketchUp. According to Ying et al. (2011), SketchUp is used to automatically construct 3D models with attributes and thematic information from 2D survey plans. They stressed that spatial topologic relationships and operations are analysed with the programming and development of the Ruby language.

ArchiCAD similarly remained as another most available software for BIM essential. ArchiCAD allows its users to create 3-D structures with “smart objects” such as walls, slabs, roofs, doors, windows and furniture. 2-D drawings (plan and elevation views) can be created from 3-D creations (KIA 2013). Jiang, (2011) indicated that ArchiCAD is the Virtual Building Explorer, a real-time 3D navigation that is enhanced with gravity, layer control, fly-mode, egress recognition and pre-saved walkthroughs. AutoCAD Civil 3D equally emerged as one of the most available software for BIM essential. Varela-González (2013) suggests that AutoCAD Civil 3D software is a BIM solution for design and documentation in the civil engineering field from Autodesk. AutoCAD Civil 3D supports BIM and helps reduce the time it takes to design, analyse, and implement changes (Autodesk, 2017). Convincingly, AutoCAD was one of the most available software for BIM essential. Autodesk (2017) hints that AutoCAD software provides the power and flexibility to help drive your projects from concept through creation quickly and efficiently; visualize design concepts within a 3D environment, quickly and accurately document designs, and collaborate with clients and contractors to save time and money. The study conducted by Danso (2012) found that the most known general CAD software program in the Universities in Ghana offering civil engineering and related programs is AutoCAD.

## **CONCLUSION**

The study sought to investigate the use of BIM and its impact on construction performance within the Ghanaian construction industry. With regards to the levels of importance of improvement in performance on construction projects as a result of adopting and implementation of BIM in the construction industries in Ghana, nine of the levels considered to be very important were: increases productivity, improves product quality and creates customer value, helps in removing barriers and constraints, reduces the time of project design and shop drawings, improves communication effectiveness, provides accurate cost estimation and take off materials, reduces conflicts and number of claims, reduces defects in the construction phase, and increases collaboration in project design. The study, therefore, concludes that stakeholders in the Ghanaian construction industry have a competitive advantage over other non-BIM users as the BIM application in construction projects reduces. The study recommends that experts and stakeholders should encourage the use of BIM technology in Ghanaian construction industry to improve construction project performance to meet customer satisfaction and also boost the infrastructural development.

## REFERENCES

- Acquah, R., Eyiah, A. K., & Oteng, D. (2018). Acceptance of Building Information Modelling: a survey of professionals in the construction industry in Ghana. *ITcon*, 23, pp.75-91.
- Agele, J. A. (2012). Adoption of Building Information Modeling and Nigerian's Quest for Project Management.
- Ahadzie, D. K., & Amoa-Mensah, K. (2010). Management practices in the Ghanaian house building Industry. *Journal of Science and Technology (Ghana)*, 30(2).
- Akadiri, P. O., & Olomolaiye, P. O. (2012). Development of sustainable assessment criteria for building materials selection. *Engineering, Construction and Architectural Management*.
- Akwaah, G. (2015). Guideline for building the capacity of contractors for adoption and implementation of building information modelling (BIM) in Ghana (Doctoral dissertation).
- Allen, C., & Smallwood, J. (2008). Improving construction planning through 4D planning. *Journal of Engineering, Design and Technology*.
- Alvarez-Romero, S. O. (2014). Use of building information modeling technology in the integration of the handover process and facilities management (Doctoral dissertation, Worcester Polytechnic Institute).
- Aram, S., Eastman, C., & Sacks, R. (2014), January. A knowledge-based framework for quantity takeoff and cost estimation in the AEC industry using BIM. In *The 31st International Symposium on Automation and Robotics in Construction and Mining*.
- Aranda-Mena, G., Crawford, J., Chevez, A., & Froese, T. (2009). Building information modelling demystified: does it make business sense to adopt BIM? *International Journal of managing projects in business*.
- Armah, N. N. O. (2015). Assessing the Benefits and Barriers of the use of BIM in the Ghanaian Construction Industry. Unpublished Thesis in Construction Management. Kwame Nkrumah University of Science and Technology, Kumasi.
- AutoCAD, L. T. (2009). Autodesk®.
- Autodesk, (2017). Autodesk®.
- Azhar, S. (2011). Building information modeling (BIM): Trends, benefits, risks, and challenges for the AEC industry. *Leadership and management in engineering*, 11(3), pp.241-252.
- Azhar, S., Hein, M. & Sketo, B. (2008), April. Building information modeling (BIM): Benefits, risks and challenges. In *Proceedings of the 44th ASC Annual Conference* (pp. 2-5).
- Azhar, S., Khalfan, M., & Maqsood, T. (2012). Building information modelling (BIM): now and beyond. *Construction Economics and Building*, 12(4), pp.15-28.
- Azhar, S., Khalfan, M., & Maqsood, T. (2012). Building information modelling (BIM): now and beyond. *Construction Economics and Building*, 12(4), pp.15-28.
- Bryman, A. (2004). Qualitative research on leadership: A critical but appreciative review. *The leadership quarterly*, 15(6), pp.729-769.
- Bynum, P., Issa, R. R., & Olbina, S. (2013). Building information modeling in support of sustainable design and construction. *Journal of construction engineering and management*, 139(1), pp.24-34.



- Campbell, D. A. (2007), April. Building information modeling: the Web 3D application for AEC. In Proceedings of the twelfth international conference on 3D web technology (pp. 173-176).
- Carmona, J., & Irwin, K. (2007). BIM: Who, what, how and why. *Building Operating Management*, 54(10), pp.37-39.
- Chen, L., & Luo, H. (2014). A BIM-based construction quality management model and its applications. *Automation in construction*, 46, pp.64-73.
- Chen, Y. (2013). *Measurement Models of Building Information Modeling Maturity*. (Ph.D), Purdue University, Ann Arbor
- Cicmil, S., & Marshall, D. (2005). Insights into collaboration at the project level: complexity, social interaction and procurement mechanisms. *Building Research & Information*, 33(6), pp.523-535.
- Computer Integrated Construction, C. (2013). *BIM Planning Guide for Facility Owners: The Pennsylvania State University*, University Park, PA, USA.
- Computer Integrated Construction, CIC. (2011). *BIM Project Execution Planning Guide* (pp. 125): Pennsylvania State University.
- Conca, F. J., Llopis, J., & Tariq, J. J. (2004). Development of a measure to assess quality management in certified firms. *European journal of operational research*, 156(3), pp.683-697.
- Creswell, J. W., Klassen, A. C., Plano Clark, V. L., & Smith, K. C. (2011). *Best practices for mixed methods research in the health sciences*. Bethesda (Maryland): National Institutes of Health, 2013, pp.541-545.
- Crotty, R. (2013). *The impact of building information modelling: transforming construction*. Routledge.
- Czmoch, I., & Pękala, A. (2014). Traditional design versus BIM based design. *Procedia Engineering*, 91, pp.210-215.
- Dakhil, A. J., Underwood, J., & Alshawi, M. (2019). Critical success competencies for the BIM implementation process: UK construction clients. *Journal of information technology in construction (ITcon)*, 24, pp.80-94.
- Danso, H. (2012). Assessment of the awareness of structural computer aided design programs of universities in Ghana. *European Journal of Social Sciences*, 30(1), pp.41-47.
- Dongping, C., Heng, L., Guangbin, W., & Ting, H. (2016). Identifying and contextualizing the motivations for BIM implementation in Construction projects: An empirical study in China. *International Journal of Project Management*, 12.
- Dossick, C. S., & Neff, G. (2010). Organizational divisions in BIM-enabled commercial construction. *Journal of construction engineering and management*, 136(4), pp.459-467.
- Dubois, A., & Gadde, L. E. (2002). The construction industry as a loosely coupled system: implications for productivity and innovation. *Construction management & economics*, 20(7), pp.621-631.
- Easterby-Smith, M., Thorpe, R., & Lowe, A. (2002). *Management research: An introduction*. London, Sage Publications.
- Giel, B. K., & Issa, R. R. (2013). Return on investment analysis of using building information modeling in construction. *Journal of computing in civil engineering*, 27(5), pp.511-521.

- Goedert, J. D. and Meadati, P. (2008). Integrating construction process documentation into building information modeling. *Journal of construction engineering and management*, 134(7), pp.509-516. Gu & London 2010
- GSA, B. (2007). Guide for spatial program validation—GSA BIM guide series 02., US General Services Administration, Washington, DC.
- Gu, N., & London, K. (2010). Understanding and facilitating BIM adoption in the AEC industry. *Automation in construction*, 19(8), pp.988-999.
- Gu, N., Singh, V., & London, K. (2014). BIM ecosystem: the coevolution of products, processes, and people. *Building information modeling: BIM in current and future practice*, pp.197-210.
- Guan-pei, H. (2010). BIM and BIM software. *Journal of Information Technology in Civil Engineering and Architecture*, 4, 110-117. Taking from: A
- Hair, A. R. (2003). U.S. Patent No. 6,615,349. Washington, DC: U.S. Patent and Trademark Office.
- Hamdi, O., & Leite, F. (2012, July). BIM and Lean interactions from the bim capability maturity model perspective: A case study. In *Proceedings for the 20th Annual Conference of the International Group for Lean Construction*. The International Group for Lean Construction.
- Hardin, B. (2009). *BIM and construction management, proven tools, methods, and workflows*. Indianapolis: Wiley Publishing.
- Hergunsel, M. F. (2011). Benefits of building information modeling for construction managers and BIM based scheduling. Al Hussein, Z.K., 2016. *Using Building Information Modeling (BIM) and the Last Planner System (LPS) to Reduce Construction Process Delay*.
- Jiang, X. (2011). Developments in cost estimating and scheduling in BIM technology.
- Jung, Y., & Joo, M. (2011). Building information modelling (BIM) framework for practical implementation. *Automation in construction*, 20(2), pp.126-133.
- Jylhä, T., & Junnila, S. (2012, July). Using the Kano model to identify customer value. In *20th Annual Conference of the International Group for Lean Construction*.
- Kadefors, A. (2004). Trust in project relationships—inside the black box. *International Journal of Project Management* 22 (3), 175–182.
- Katz, G. I., & Crandall, J. C. (2010). Building information modeling: The present the construction industry. *Construction Accounting & Taxation*, 20(1), pp.26-32.
- Krygiel, E., & Nies, B. (2008). *Green BIM: successful sustainable design with building information modeling*. John Wiley & Sons.
- Kymmell, W. (2008). *Building Information Modeling: Planning and Managing Construction Projects with 4D CAD and Simulations (McGraw-Hill Construction Series)*. McGraw-Hill Education.
- Linderoth, H. C. (2010). Understanding adoption and use of BIM as the creation of actor networks. *Automation in construction*, 19(1), pp.66-72.
- Maunula, A., & Smeds, R. (2008). The implementation of building information modeling (BIM): A process perspective. *Teknillinen korkeakoulu*.

- Maurer, I. (2010). How to build trust in inter-organizational projects: The impact of project staffing and project rewards on the formation of trust, knowledge acquisition and product innovation. *International journal of project management*, 28(7), pp.629-637.
- Mihindu, S., & Arayici, Y. (2008, July). Digital construction through BIM systems will drive the re-engineering of construction business practices. In 2008 international conference visualisation (pp. 29-34). IEEE.
- Mom, M., Tsai, M. H., & Hsieh, S. H. (2011, November). On decision-making and technology-implementing factors for BIM adoption. In *International Conference on Construction Applications of Virtual Reality* (pp. 86-92).
- Nani, G., & Akwaah, G. (2015). Guidelines for Capacity Building of Construction Firms for Building Information Modeling (BIM) Adoption in Ghana. ARCA, p.468.
- Naoum, S. G. (1998). *Dissertation Research and Writing for Construction Students*, Oxford: Bultermouth-Heinemom.
- Nath, T., Attarzadeh, M., Tiong, R. L., Chidambaram, C., & Yu, Z. (2015). Productivity improvement of precast shop drawings generation through BIM-based process re-engineering. *Automation in Construction*, 54, pp.54-68.
- National Institute of Building Science (NIBS) 2007, United States National Building Information Modelling Standard™ Version 1 - Part 1: Overview, Principles, and Methodologies.
- Parvan, K. (2012). Estimating the impact of building information modeling (BIM) utilization on building project performance (Doctoral dissertation).
- Patton, M. Q. (2002.) Two decades of developments in qualitative inquiry: A personal, experiential perspective. *Qualitative social work*, 1(3), pp.261-283.
- Reinhardt, J., & Klancnik, D. (2009). *The Contractor's Guide to BIM— Appendix C: BIM Tools Matrix.* AGC of America.
- Saeed, K. I. A. (2013). Review of Building Information Modeling (BIM) Software Packages Based on Assets Management. Amirkabir University of Technology, Department of Civil and Environmental Engineering, 27.
- Saunders, M. N. K., Lewis, P., & Thornhill, A. (2012). *Research methods for business students* (6th ended.) Harlow. England: Pearson Education.
- Shuttleworth, R., Russell, C., Weerakoon, P., & Dune, T. (2010). Sexuality in residential aged care: A survey of perceptions and policies in Australian nursing homes. *Sexuality and Disability*, 28(3), pp.187-194.
- Staub-French, S., Fischer, M., Kunz, J., & Paulson, B. (2003). A generic feature-driven activity-based cost estimation process. *Advanced Engineering Informatics*, 17(1), pp.23-39.
- Stine, D. J. (2012). *Design Integration Using Autodesk Revit 2013*. SDC Publications.
- Succar, B. (2010). Building information modelling maturity matrix. In *Handbook of research on building information modeling and construction informatics: Concepts and technologies* (pp. 65-103). IGI Global.
- Succar, B., Sher, W., & Williams, A. (2012). Measuring BIM performance: Five metrics. *Architectural Engineering and Design Management*, 8(2), pp.120-142.
- Turk, Ž. (2016). Ten questions concerning building information modelling. *Building and Environment*, 107, pp.274-284.

- Uddin, M. M., & Khanzode, A. R. (2014). Examples of How Building Information Modeling can enhance career paths in construction. *Practice Periodical on Structural Design and Construction*, 19(1), pp.95-102.
- Vanlande, R., Nicolle, C., & Cruz, C. (2008). IFC and building lifecycle management. *Automation in construction*, 18(1), pp.70-78.
- Varela-González, M., González-Jorge, H., Riveiro, B., & Arias, P. (2013). Performance testing of LiDAR exploitation software. *Computers & Geosciences*, 54, pp.122-129.
- Won, J., Lee, G., Dossick, C., & Messner, J. (2013). Where to focus for successful adoption of building information modeling within organization. *Journal of construction engineering and management*, 139(11), p.04013014.
- Ying, S., Li, L., & Guo, R. (2011). Building 3D cadastral system based on 2D survey plans with SketchUp. *Geo-spatial Information Science*, 14(2), pp.129-136.



---

## ANALYTICAL NEXUS OF URBAN LIVEABILITY, LIVEABLE COMMUNITIES AND PLACE-MAKING IN AFRICAN CITIES

Samuel Medayese<sup>1</sup>, Hangwelani Magidimisha-Chipungu<sup>2</sup>, Ayobami Popoola<sup>3</sup> and Lovemore Chipungu<sup>4</sup>

<sup>1,2</sup>*Department of Town and Regional Planning, School of Built Environment and Development Studies, University of KwaZulu Natal, Durban, South Africa*

<sup>3</sup>*School of Built Environment & Development Studies, College of Humanities, University of KwaZulu-Natal, Durban, South Africa*

<sup>4</sup>*Department of Housing, School of Built Environment & Development Studies, College of Humanities, University of KwaZulu-Natal, Durban, South Africa*

Literature suggests that there are sets of standard variables that can explain urban liveability differentials. These variables used to examine liveable city spaces are and contribute to the constructs for urban development. Therefore, the purpose of this paper is to analyse empirical linkages within urban liveability, place-making, and Liveable communities in Africa using a partial least squares path analytic method. This study examines the interrelationship within three important constructs using a questionnaire survey to obtain data from 390 residents across twelve (12) country capitals in the four major geographical zones in African. Using a path analytic approach, the paper examines the relationship between the constructs discussed in the study. The data analysis findings show that place-making influences Liveable communities and urban liveability. Therefore, the results indicate that cities that prioritise place-making have better liveable community spaces over those that do not. The study findings have implications for liveable communities, as it could help city development planners acknowledge the influence of place-making on urban liveability and liveable communities. The study contributes to the current debate on measuring urban liveability within the African City Space.

Keywords: Africa, liveable communities, place-making, quality of life, urban liveability

### INTRODUCTION

Liveability is a composite of interrelated social, economic, and ecological indicators that promote and enhance life and sustainability quality. It is a dynamic concept that is related to time and space. It connotes the challenges to the lifestyle of individuals and communities. According to Economic Intelligence Unit (2019), the liveability assessment quantifies the challenges presented to an individual's

---

<sup>1</sup> medalandgroup@gmail.com; +2348033033184

<sup>2</sup> magidimishah@ukzn.ac.za

<sup>3</sup> bcoolay2@yahoo.com

<sup>4</sup> Chipungu@ukzn.ac.za

lifestyle. Urban liveability measures the quality or otherwise of living in urban areas or cities. Urban quality of life is based on assessments of stability, healthcare, culture and environment, education, and infrastructure (EIU, 2019). A high level of liveability ranking has been established to be positively associated with health outcomes and behaviours, including increased physical activity and improved mental health.

Further, there is a distinction between the definition of liveability in urban areas in high-income countries and low-to-middle-income countries (Alderton et al., 2019). This distinction in definition is essential as more than 95 per cent of African countries fall within low or middle-income countries. Besides, the definitions and measurement indicators of liveability are skewed to high-income countries that include indicators such as "safe, attractive, socially cohesive and inclusive, and environmentally sustainable, with affordable and diverse housing linked to employment, education, public open space, local shops, health and community services, and leisure and cultural opportunities, via convenient public transport, walking, and cycling infrastructure (Badland et al. 2015). On the other hand, the priorities and context in Africa present a different scenario. For instance, most urban areas in Africa live in informal settlements and have limited access to clean drinking water and sanitation (Smit et al., 2011).

On the other hand, the idea of 'Placemaking' from the 60s, as presented by Jane Jacobs and William H. Whyte's, brought city dwellers and social aspects into attention and offered designing cities sociable public spaces the human perspective and for people. They emphasised the importance of lively neighbourhoods and inviting public spaces. Jacob (1969) mentions the 'eyes' on the street that means more active and face-to-face social interaction. 'Placemaking is a multi-faceted approach that 'takes advantage of on a local community's assets, inspiration, and potential, ultimately creating good public spaces that promote people's health, happiness, and well-being' (PPS, 2009). Planning for high-quality public spaces to share and exchange their life, is not conducted by making huge open spaces. Flexible activities in urban places need to be defined; each open space does not ensure a liveable space. Squares have this potential to change into a desirable place with low-cost and high-impact improvement through placemaking. It is a process that 'incorporates the needs and desires of a diverse community that can go a long way to catalyse quick improvements and promote true liveability' (PPS, 2009).

Though the notion of 'place' has examined from various perspectives, it iterates people's engagement with the physical environment. The place is assumed as a pause in movement that reflects upon human experience; it is also believed to be structured according to human environmental experiences and relationships of the physical environment and behaviour (Tuan, 1977; Relph, 1976; Canter, 1977; Cresswell, 2014). He also highlights the importance of perception of the place to understand it and be aware of its stimulus. As urban planner, (Lynch, 1969; Buys, et al., 2013; Haarhoff et al., 2016) mentions the image of the place that makes it unique. As an urban designer, Gehl (2010) defines outdoor activities as 'social characteristics' of an environment. He highlights that proper physical conditions can increase social activities. Urbanist Whyte (1980) defines 'intimate experiences' that can communicate, such as sitting or eating. He believes that these experiences

attract more people. He also highlights 'bridge activities' (triangulation) as linkage, connecting strangers, and making interactions between them.

Gehl (2010) identifies a broad picture of the physical attributes of an urban environment. He mentions the importance of size, scale, and proportion of buildings and spaces between buildings and corners of streets, reinforcing social communication. Whyte (1980) states that if physical attributes are well designed and well located, people can 'experience' them and perceive the place with a strong 'image.' Activities happen in an urban environment are the social characteristics of a place. The theories addressed that diverse activities and mixed-use buildings increase the life quality of public spaces. Intimate experiences that are the result of users' senses engagement highlights the vital role of edges around; especially at the level of the ground floor that is the zone most of the interactions between people occur (Gehl, 2010) 'Experience' of a place depends on 'the level of intention' between a person and an environment (Relph,1976).

Hashem et. al. (2013) also defines this experience as an 'environmental role,' which involves individuals in the place (p178). They both highlight that 'place' is 'experienced by users in different levels and roles, making different perceptions and 'images.' Lynch (1969) focuses on this image and its power to make 'place identity. Relph (1976) mentions the symbolic meaning of an urban environment, which results from human experiences. It is the contribution of observed activities and physical attributes that make 'place identity. Gifford (2002), psychologist and environmentalist, marks that we identify ourselves with the place we belong to; it is called a 'sense of attachment.' When a group of people has a sense of attachment to an environment, it provides a sense of belonging to a community that people are proud of. It causes a sense of satisfaction and comfort, resulting in dynamic interaction and social communication between people.

The interrelationship and linkages within the concepts of Place-making, Urban Liveability, and Liveable communities have a dearth of literature as related to African Cities. Most literature tends to take each of these concepts at the individual level and presented them on a literature basis. However, this research explores the three concepts' analytical linkages from a partial least square standpoint as an empirical method measuring the concepts' linkages. The research employed the partial least square (PLS) approach to determine the effect size of the indicators employed to measure each of the concepts and analyse the indicators variables' predictive value related to the concepts' linkage across African Cities.

## LITERATURE REVIEW

### **Theorising urban liveability from the modernisation spectrum**

Discussions on liveability within planning networks often draw on both conservative and progressive impulses. Liveability is a complex and unstable set off understandings combining nature, society, urbanity, and nostalgia; this marks liveability as neither inherently inclusive nor revanchist. Examining liveability articulations provides an avenue for researchers to interrogate the redevelopment of historic industrial landscapes, the knowledge of urban planning and design, and their consequences, without necessarily retreating to a deterministic reading of particular projects, processes, or motivations.

Pinning down a definition for 'liveability' proves difficult, as it has become a highly mutable term. Definitions of liveability have evolved from focusing on a city's visual aesthetics to revitalisation through amenity creation. In current policy, usage is being stretched to include all manner of job creation or creative economy initiatives (Hagerman, 2007). Criteria that define a place as liveable are easier to come by and reflect a focus on urban design, environmental quality, and human and economic development. Initially, liveability discussions focused on central cities and ways to reclaim the economic, retail, and social centrality of downtowns. During the 1990s, increasing attention paid to urban sprawl brought together several criticisms of suburban development—it ate up open space, was racially and economically homogenous, socially deadening, poorly designed, automobile-dependent, and environmentally destructive, from the scale of wetland habitat adjacent to a subdivision to global warming caused by automobile emissions. Sprawl became a foil for liveability. A liveable community, then, does not sprawl—it has a distinct centre, coordinates land use and transportation, is socially inclusive, and focuses on environmental preservation.

At the root of the interest in creating and tracking liveability is a condemnation of industrial modernism and post-war urban form. The factories and industrial uses that spawned massive urban growth in the late 19th and early 20th centuries destroyed the City's liveability, and suburbanisation was an attempt to find it outside the City. Now coping with the loss of population and industry, central cities seek to focus on the new 'creative' or 'knowledge economy,' which completes the removal of industrial landscapes, replacing them with new neighbourhoods for residents returning from their exile in the 'burbs.' The social, environmental and economic consequences of modern urbanism and sub-urbanism are the backdrop to the calls for increasing liveability, concerning historic forms reflecting an uncritical nostalgia for landscapes from the pre-modern past.

Under a variety of labels, such as new urbanism and neo-traditionalism, planners, architects, and designers have valorised the urban forms that pre-dated the automobile era of American cities, conceiving a more liveable landscape in terms of reduced automobile dependence, walkable neighbourhoods, and more excellent proximity to transit, shopping, and entertainment. The return to these ideas of a (perhaps only imagined) bygone era responds to a perceived lack of sociability in the modern suburb (Chauvet et al., 2017) a perception that there has been a breakdown of civility in the inner City (Beauregard, 1993; Smith, 1996) and nostalgia for a bygone pre-industrial relationship between culture and nature (Gandy, 2002). The polluting industrial uses that dominated the waterfronts of that era are not included in these visions. Instead, access and reclamation of waterfront nature figures prominently into assessments of a metropolis's liveability, broadly defined but distanced from the environmental and social disruptions that accompanied the industrial past.

In many ways, liveability could encompass a wide range of issues related to the overall 'quality of well-being and life.' It is instinctive to understand this as a 'place-based' concept. Generally, it refers to the fundamentals of a home, neighbourhood, or City that can contribute to a better quality of life and well-being. Quality of life and well-being are so close in terms and related concepts related to the extent to which an individual's living condition can be measured and analysed. They can



range from more objective indicators of economic well-being, such as human capital, to the more subjective quality of life indicators that include social capital, qualitative expressions of personal satisfaction, and the like (Ley and Newton, 2010).

From Woolcock (2009), we can see that the linkage between liveability and sustainable development is not very clear either. In some cases, these two terms are being used interchangeably, while in some other contexts, liveability is considered a subset of a sustainable city (Lewandowska & Szymańska 2021). Even the definition for 'sustainable cities' is still vague to many people (Eastaway & Stoa 2004; White 1994), especially concerning what is to be sustainable. One way to come to a grip with the sustainable City is to ground it on the people's life and activities, hence using a 'liveable city' to capture the serene but rewarding life of city people.

'Liveable' City nonetheless is a very subjective word also. What more if it concerns a liveable city. It is very much similar to an old proverb, ' beauty lies in the eyes of its beholder.' Different people have different opinions about what they call a liveable city. Shortell (2005) points out that whether it is meaningful or not depends very much on the country's status, whether it is a developed or developing country. This view coincides with Mahapatra (2017). description of a liveable city that reflects the 'quality of life (wealth and beyond) experienced by the city residents.

In comparing a liveable city to a sustainable city concept, Douglass et al. (2004) maintain that a liveable city concept is more health, social and human-centred. This was buttressed by Aziz and Hadi, (2007), that described the liveable City as having healthy and walkable neighbourhoods, a network of attractive public spaces and buildings, affordability, clean, vibrant with diverse street culture.

It is seen that the top cities are mostly mid-sized, in wealthier countries, and with a population density that is relatively on the lower side, the report states. "These can foster a range of recreational activities without leading to high crime levels or overburdened infrastructure," it also adds. "Six of the ten top-scoring cities are in Australia and Canada, which have, respectively, population densities of 2.9 and 3.7 people per square kilometre. Nevertheless, in the top 10, Finland and New Zealand have densities ranging between 15 and 18 per square km of land area. On the other hand, the global average density is 57 people/sq km.

"Though Austria has a density of 106 people per square km, comparing with megacities like New York, London, Paris, and Tokyo, Vienna's population of nearly 1.8m (2.6m in the metropolitan area) is comparatively small. New York, London, Paris, and Tokyo are all prestigious hubs with a wealth of recreational activities and other cooperative things for their country's people. However, all these cities are suffered from higher levels of crime, congestion and public transport problems" (Oliver, 2017).

Australian cities are doing well in the known international liveability rankings of cities worldwide because of comparatively lower crime rates, high amounts of public open space for its inhabitants, fairly good transport systems, and the accessibility of good educational opportunities (David & Melanie, 2013). Vienna has excellent infrastructure which has been designed to fulfil the changing needs

of the City. Vienna scores mainly in terms of its public transport and public housing. The City has provided its inhabitant's affordable housing. It has made an excellent bicycle route map that keeps the traffic on the lower side and discourages people from using private cars as it is a better way to improve the air quality.

Population growth is visible in developing countries' fast-growing cities (Kolkata, Dhaka, Mumbai, Delhi, Pune, Bangalore, Karachi, and Islamabad). A sense of the population growth rate can be found by observing Asian developing countries' growing cities. In 1950, these cities' population was 306 million, which could be around 3500 million in 2030. As per percentage, it could be about 57 per cent of these countries' total population (Cohen, 2006). For the fast-growing population, these cities have to face many adverse conditions in increasing the living standard.

Furthermore, to deal with this situation, the living standard of these cities is declining. This is due to the declining or low quality of civic facilities (Douglass, 2002). This condition is further iterated by the city housing backlog and demand of over a 2.7billion city resident (rural immigrant inclusive) in developing countries by 2050 (Oehlers, 2006; World Bank, 2013).

Modernisation theory is an economic theory rooted in capitalism that evolved in the 1950s and 1960s. Modernisation is a comprehensive theory that deals with a nation's whole process to transform from a primitive to a modernised society. The modernisation consists of a gradual process of specialisation and separation of social structures to promote efficiency in any society's developmental process. Modernisation theory operates on economic-oriented principles that posit that capital formation and investment are the major determinants of economic growth and development. (Adah & Abasilim, 2015; Ifeoma et. al., 2020). The theory of modernisation is the stage model, which views development as a process that passes through various evolutionary phases. The stage model's primary focus is that development follows specific stipulated frameworks; thus, nations who seek to achieve economic growth must adhere to this framework. The stage model described by Foster-Carter, (1976) and Ish-Shalom, (2006). is divided into five stages: the traditional society, the precondition for the take-off stage, the take-off stage, the maturity stage, and the stage of high-mass consumption.

The traditional stage is an agrarian society that is not aware of its capability to transform its society into a modern community. They are, therefore, not willing to take advantage of the potential of modern science and technology. At the precondition stage for take-off, society becomes aware of its transformative potential and applies modern science and technology to agricultural and industrial practices. The opportunity for investment and commerce, therefore, increases at this stage. The take-off stage places emphasis on the eradication of traditional obstacles, which hinders economic growth and development. At this stage, the commercialisation of agriculture is introduced, and investment rises to a maximum level. The drive to maturity stage is when the economy shows the capacity to extend beyond the original industries that served as its pivot for take-off. The final development stage is high mass consumption; it produces durable consumer goods and services, marked by a rise in real income. Implicit in the stage model assumes that some countries are developed because of their strict adherence to this evolutionary developmental process.

Modernisation is a complex process involving all human thoughts and behaviour and cannot be reduced to a single factor or dimension. Its component includes industrialisation, urbanisation, social secularisation media mobilisation, expansion of political participation, and increasing literacy (Jhingan, et. al. 2008). Modernisation is a systemic process: it is holistic, meaning that change in one phenomenon could change other phenomena such as literacy, leading to increased awareness. Modernisation is a global process that started around Europe but has become a worldwide phenomenon. This was primarily brought about by integrating modern ideas and techniques from the European countries to the peripheries and different countries' internal development. Modernisation is a lengthy process such that it took Western Europe and other societies several centuries to modernise; however, it can take a contemporary society a lesser time to modernise. Modernisation is a phased process meaning that it is possible to distinguish between different levels or phases of modernisation through which all societies will move.

Modernisation is a homogenising process: modern societies have universal values and share some basic similarities, and are interdependent—for example, interdependence among EEC countries. Modernisation is an irreversible process- it does not rewind. Modernisation is a progressive process: although the cost of modernisation is painful, modernisation is necessary and desirable because it brings material well-being to society. Modernisation is a historical process: it is characterised by a step-by-step development in the social system element. The process has reached a stage in some parts of the world, and this part serves as a model for understanding the nature of the modernisation process. Incidentally, this part of the world is described as the West. However, modernisation is not westernisation since every process of modernising has its own culture and environmental uniqueness.

Simmel (1903) posited urban life as a critical subject of social science study. Bielo (203) noted how well his analysis of urban characteristics has held up over the last 100+ years; that urbanism is characterised by humans' connection to the built environment, the economic efficiency and psycho-social implications of short functional encounters, the overload of the senses and subsequent screening of sensory attention, the anonymity that leads so often to indifference and alienation, the cosmopolitanism of diversity, and the City as the epicentre for cultural development. The expansion of cities in the aftermath of the industrial revolution led many to associate urbanisation with secularisation, implying that urbanisation and secularisation were viewed as a part of modernisation (Williams 2011: 87). As urbanisation grew, the number of people in cities increased, which offered greater exposure to varied lifestyles and greater dependence on rationalisation due to urbanisation's materialism and market fundamentalism. Nevertheless, as with the fate of most other secularisation forecasts, any strict correlation between rising urbanism and rising secularism has failed to materialise (Casanova 1994).

## **Conceptual framework and hypothesis development**

### ***Liveable communities and urban liveability***

The National Research Council (2002) defined liveability as a concept that encompasses sustainability, quality of life, place identity and health space. This ideology placed within an urban space provokes urban liveability thinking and

improves a space's ability to be liveable. As a term that endues the need for human needs to be met, the understanding is that collection of liveable communities of various hierarchy makes up a city or urban settlement that is liveable. The character of a place considers some of these same attributes as bundles of features linked to particular places (e.g., how a community's health is affected by air quality or access to health services). The character of a place considers some of these same attributes as bundles of features linked to particular places (e.g., how a community's health is affected by air quality or access to health services) (National Research Council, 2002:24). It is reported that human settlements' quality exerts a significant influence on human health and well-being (Liang et al., 2020), especially in a micro-macro settlement relationship (Popoola et al., 2020). The lifestyle identifiers or indicators of a micro-community is thus essential to understand macro-city/urban area. Part of the push toward more liveable communities is related to social well-being concerns (distribution, rather than economic resources allocation), another composite concept (Smith, 1973). This allocation capacity of the social good is dependent on the decision-makers within the urban sphere as the micro-community experience is an overflow of the urban social allocation.

Kashef (2016:242) mentioned that humans and their surrounding physical environments (communities) interact to create a state of equilibrium that has been sustained over a long period. Liveable environments integrate physical and social well-being parameters to sustain a productive and meaningful human existence; productive in the sense that the social clustering of humans yields considerably more than the total of individual productivity, and meaningful in the sense that humans need, by their very nature, to participate in forming thriving and self-sustaining social systems (Asia-Pacific Economic Cooperation, 2015; Kashef, 2016). Chiu (2019:1) pointed out that urban liveability speaks to all classes' quality of life and city dwellers' groups within the dynamic and heterogenous urban and City setting. That is the individualistic social expression of a person or a community within a larger urban space. These city groups and dwellers often is a collection of dependent communities. The perception is that communities are not independent entities away from the urban spaces. After all, the evolution of local communities is what translates into urban. This was further buttressed in Higgs et al. (2019) and Alderton et al. (2019), where the Melbourne Australia and Low and Middle-income countries experiences present the neighbourhood (smallscale communities) functioning in a city area.

The validation was that urban liveability (as measured in availability and accessibility) is essential to creating more liveable communities. The view was that such interaction could produce co-benefits for public health, the environment and managing traffic congestion. The study concluded that urban liveability is imperative in measuring liveable neighbourhoods (small communities, as the case may be). The ideology was that urban liveability evaluation and framing is critical to policy, plan or programme deliverable along with more minor spatial-regional interests. For instance, Alderto et al. (2019) exemplified that neighbourhood walkability as a micro-determinant or indicator of liveability is essential to managing the City's climate change effect. These community indices will help mitigate climate change (manage urban heat island effect, reduce traffic through reducing car dependence and greenhouse gas emissions) in urban areas. Thus, the study hypothesises that:

H1: There is a positive relationship between liveable communities and urban Liveability

### ***Place-making and liveable communities***

Spatially, the place is critical to the quality of life and community livability. In providing an understanding of the relationship between placemaking and liveable communities, Institute for Public Administration (2021) wrote that creating a liveable community envisioned as inclusive and sustainable, community residents' views could not be downplayed. The view was that in creating a sense of community character, placemaking encourages citizens to improve their environments, especially those they share with their neighbours. Placemaking as an economic development strategy, also called place-based economic development, uses a community's public amenities to make economic progress. This approach focuses on the unique features of particular places, building on existing assets, and using them to attract new investment and strengthen existing businesses.

Placemaking as an economic development strategy is particularly relevant in today's age of globalism. Jobs tied to this form of economic development are tied directly to specific places and cannot be outsourced. When communities commit to using placemaking as an economic development method, the benefits extend far beyond enticing visitors, entrepreneurs, small businesses, and corporations. To local economies recovering from a loss of conventional industry, placemaking is a method for capitalizing on existing strengths rather than inventing new ones to develop a more robust economy. This process of communities' involvement in making their places liveable, according to the American Planning Association (2021), is termed creative placemaking. In the concept of creative placemaking, communities through collective engagement, residents' participation and shared responsibility are applied to economic development and community revitalization towards making the communities liveable.

Place-making, through layout and design, is an integrative planning approach in creating sustainable communities. Place-making is fundamentally a strategy to create one or more places in an area that serve as focal points for people's economic and social activities (Schlebusch, 2015: 59). Such places will contribute to the quality of life in a community and encourage more people to visit the area. Schlebusch (2015: 62) further narrated that an effective Placemaking process capitalizes on a local community's assets, inspiration, and potential, ultimately creating suitable public spaces that promote people's health, happiness, and well-being". Thus, place-making is a continuous process, which encapsulate peoples' ideas and through which their needs in terms of liveability and quality of life are fulfilled by using effective planning, layout and design or redesign of their environment (Project for Public Spaces, 2007). The collective envisioning and triangulation approach aims to discover the local community's needs and ambitions towards a liveable community. Aligning to how the immigrant community makes their place liveable, Main and Sandoval (2015) valued that identity relevance was critical in the configuration and arrangement of communities to be liveable. In their study, local community placemaking was perceived as the globalization (which is embedded in liveability) of the local communities. To this end, Borrup (2016:50) said placemaking builds on local

human, physical, and cultural assets to enhance the social and civic fabric. These assets and fabric are the foundation for a liveable community. As Wyckoff (2014) said, placemaking will directly help enhance the neighbourhood and indirectly promote living quality in communities. This is because the creative process of making communities (placemaking) is somewhat targeted at community development (liveability) (Ellery & Ellery, 2019). To this end, this study arrived to test the hypothesis (H2) that:

H2: There is a positive relationship between place-making and liveable communities

### ***Place-making and urban liveability***

Friedmann (2010:150) states that the literature on the City is filled with references to desolate placelessness and a yearning for place, for some solid connection to the earth, to cities' palpable physicality, the everyday need for social contact. This is why the author arguing from Lefebvre's right to the city' provokes the thinking for a collaborative and collective engagement among planners and other city stakeholders in the configuration of places towards liveability. The role of stakeholders in forming a place identity called 'place-making remains critical to cities' planning framework. The International Experts for Research Enrichment and Knowledge Exchange (2016) posted that place-making is a people-centred approach in planning and designing public spaces in cities. This approach pays attention to the opinions of the people living in a particular place and to discover their needs from this place and their aspirations towards it. The central perspective of using place-making in urban planning is to create places where the citizens feel engaged. They alluded that place-making plays a vital role in achieving sustainable societies by empowering communities and inclosing between cultures and societies.

The liveability of places is set by many factors, which are in turn influenced by a variety of tangible and intangible elements - such as good quality design and materials, place identity, accessibility, and so on - concerning the area in question and its surrounding (AAVV, 2017; Appleyard, 1981; Francis, 2016, Kyttä et al., 2015; Burns, 2005). Urban environments are increasingly designed to be distinctive, creating memorable sensory experiences and giving happiness to the people who use them. Through the analysis of places, a more detailed and qualitative interpretation of the City is carried out. This is not circumscribed to its aesthetic essence or physical geometry (Gehl, 2010; Kyttä et al., 2015; Lynch, 1960; Madanipour, 2003). The functional and symbolic interpretations of a place's elements are the fundamental factors for understanding its meaning. Moreover, "as society changes, so do signification (McCay, 2017; Montgomery, 1998, 2013). Meanings attached to the built environment become modified as social values evolve in response to changing patterns of socio-economic organisation and lifestyles" (Porteous, 1977; Carmona, et. al., 2010).

Nowadays, new attention to urban liveability has been given but often in terms of theoretical sense or an observational point of view. Indeed, the definition of urban liveability is strongly interwoven with social, environmental, economic, philosophical studies and, according to with new crisis and the consequent

transformation of lifestyles, needs, and habits, the definition is in continuous change (Wang et al., 2016; Whyte, 1980; Zelinka et al., 2001).

Presenting the Pacific Asia argument, Ho and Douglass (2008:199) presented the view that inserting local communities' place-making efforts in creating liveable urban environments cannot be downplayed in the global city research agenda. They state that such an approach argues for a shift in focus from examining the City in terms of its economic competitiveness to better understand the City's local textures by incorporating social and political processes (p.199). If that is so, the potency of place-making as a grassroots tool is critical to the urban liveability concept is unbundling. Kneeshaw (2017) posited that the process of placemaking itself requires both 'hardware' – landscaping, lighting, parks, planting, street art and 'software'- the all-important programming of activity that attracts people to spaces and brings them to life. This hardware is a critical configuration towards a liveable urban area. The argument was that city makers must understand that stakeholders' place-making capacity in a collaborative approach remains imperative to city liveability and sustainability.

According to Sepe (2017), the liveability of places is set by many factors, which are in turn influenced by a variety of elements - both tangible and intangible - concerning the area in question and its surroundings. One of these factors is constituted by urban happiness, which, together with the term sustainability meant in its broad meaning, constitutes a key concept in placemaking. Drawing experience from HafenCity, Hamburg revealed that urban regeneration, which promoted new public spaces and city change, improved city liveability among indigenous settlers and immigrants (Sepe, 2017). This is further buttressed by the notion that physical content that captures places' making is critical to life quality and liveability. Thus, drawing from an African perspective hypothesises a relationship between place-making and urban liveability. Given the interlinks between place-making and urban liveability, which tends to establish the fact that liveability is strongly linked to the extent of modification of spaces within the urban environment to give comfort and happiness to inhabitants, this research, therefore, hypothesises that:

H3: There exists a positive relationship between place-making and urban liveability

From the three hypothesis advanced above, a conceptual framework which shows the linkages and interactions within the three measured constructs is shown in Figure I and it is on the basis of this conceptual nexus that the model for the analytical nexus of urban liveability, liveable communities and place-making is premised.

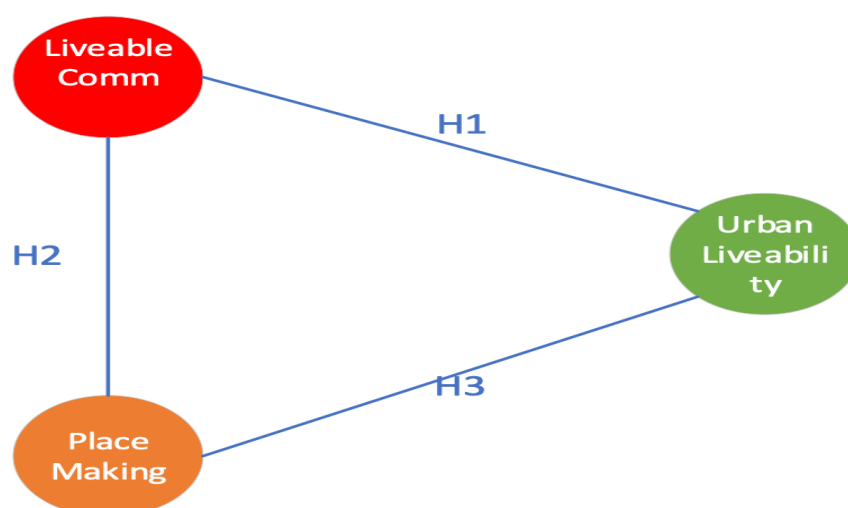

Figure 1: Conceptual Framework for the linkage of Urban liveability-Liveable communities-Place-making

Source: Author's Design, 2021

## RESEARCH METHODOLOGY

This study followed a quantitative analysis approach to evaluate the theories formulated. This research is based on a post-positivism model, which depends on respondents' experience as a legitimate source of information from which the world is perceived. This study thus aligns with the ontological role of objectivity, and thus, from the epistemological point of view, there was no relationship between the study and the researchers. This research was value-free, based on Isenhower, et. al. (2010) assumptions. This study performed a comprehensive literature review to define the variables used to test each of the conceptual structure's essential constructs. Bowen et al. (2010) used the method where a sectioned questionnaire was used using closed-ended questions. There are three sections contained in the survey questionnaire. Section A deals with place-making indicators, B is the liveable communities' indicators, and C is the Urban Liveability indicators. This included questions about the structures of the City's constituent variables, which were structured to examine place making's interrelatedness and its effect on community liveability and overall urban liveability factors. The questions were intended to collect data on the respondents' perceptions of placemaking as an endogenous variable that drives liveable communities and urban liveability as the exogenous variables. The respondents were asked to rate the responses on a scale of 1-5, where one was "strongly disagree" with 5 "strongly agree." Table 2 illustrates the observed latent structures and the metrics used in the analysis. The research structure out Africa into four regions (South Africa, West Africa, North Africa and East Africa). Three Countries were purposively selected within each region and the questionnaires were administered in the capital city of the selected country. Table 1 shows the selected cities and the number of questionnaires administered.



**Table 1: Structure of Cities Selected and Number of Questionnaires Administered**

Region	Selected Countries	Capital Cities	Number of Questionnaires Administered
Southern Africa	South Africa	Durban	30
	Zimbabwe	Harare	30
	Malawi	Lilongwe	30
Western Africa	Nigeria	Abuja	40
	Gambia	Banjui	30
	Ghana	Accra	30
Eastern Africa	Uganda	Kampala	30
	Kenya	Nairobi	40
	Namibia	Windhoek	30
Northern Africa	Morroco	Rabat	30
	Egypt	Cairo	40
	Algeria	Algiers	30
Total	12	12	390

**Data collection**

Data were collected using an online survey google form sent to different respondents across African Cities using multiple samples of purposive and snowball sampling approach, which allows for targeted (African origin respondent) linkage from person to person based on recommendation available information. Most of the respondents sampled through this medium were academics and information and communication technology inclined respondent across s Africa. Most of the respondents sampled have social media presence for over five years, most especially on Facebook, Twitter, WhatsApp, and LinkedIn. Structured questionnaires were sent to these respondents through the various media listed above, and a total of 400 respondents were self-administered. This method of data collection allowed for clarification and ensured a high-response rate. As the variables used in the study were adapted, there was no need for a pilot study to demonstrate that all questions were clearly understood. A total of 390 responses were obtained. The survey response of 390 was considered good enough for the data analysis method adopted, thus, considered suggestive and appropriate for exploratory research. Table 2 shows the sources of measurement indicators adapted for the survey.

**Table 2: Measurement Indicators and Sources in Literature**

SN	Latent Variables	Indicators	Sources of Measurement Indicators
1	Urban Liveability	Increase in Property Value Improved Connectivity Security Well-being Sense of belonging	Dempsey and Burton, 2012; Lynch, 1960; Carmona et al. 2010; Jacobs, 1961
2	Placemaking	Racial Justice, Social Inclusion, Network Establishment amongst residents; Social networks and capital, Visual Aesthetics	Crowe, 1995; Heidegger, 1971; Carmonia et al. 2010, Groat & Wang (2013).
3	Liveable Community	Social, environmental, and economic aspects of the urban space, entrepreneurship, Smart living	Malek and Idris, 2016; Badarulzaman, 2011, Ge and Hokao, 2006

## DATA ANALYSIS

The survey data was analysed using the structural equation modelling of partial least squares (PLS-SEM). The partial least squares (PLS) approach to structural equation modelling (SEM) was adopted in this analysis to analyse the reliability and validity of the latent variables and evaluate the formulated hypotheses. For some purposes, PLS-SEM was selected; however, Rigdon (2014) argued that some of the reasons for using the PLS approach in research could not be used as justification. PLS manages knowledge that is typically not distributed due to the simplicity of distribution assumptions (Henseler et al., 2009). Hair et al. (2014) underscored this claim, claiming that PLS-SEM for non-normally distributed data and limited sample sizes is stronger than CB-SEM. This is because PLS provides a higher degree of statistical power and demonstrates enhanced convergence activity (Henseler and Fassott, 2010; Reinartz et al., 2009). PLS has been used by previous social media studies to test route models (Parveen et al., 2016; Mahmoudi et al., 2015) and test theory (Chin, 1998). Thus, SmartPLS v2.0 was used in this research to assess discriminant validity, convergent validity and test the hypotheses mentioned. Table 3 shows the indicator codes and factor loadings with the interpretation of indicator questions asked in the research.

**Table 3: Indicator Codes and Factor loadings**

Indicator Code	Indicator	Factor Loading
Placemaking		
PL 4	City Connectivity	0.768
PL 5	Ease of obtaining help in terms of healthcare	0.812
PL 6	Ease of visitor's access to accommodation in your City	0.814
PL 7	Ease of obtaining financial help in your City	0.744
PL 8	Ease of obtaining help in terms of healthcare	0.800
PL 9	Ease of financial flow network in case of need in your City	0.785
Liveable Community		
LC13	City or area accessible in terms of transportation	0.781
LC14	Area aesthetics	0.771
LC15	Area correctly linked by transport infrastructure	0.726
LC16	Social opportunities in your area	0.815
Urban Liveability		
UL 1	Social Cohesion in the City	0.753
UL 2	Economic Viability of the City	0.724
UL 3	Environmental Justice in the City	0.778

### Measurement Model

The analysis was conducted using SmartPLS (version 2.0 M3) software to test the model's predictive power by using PLS-SEM in evaluating the measurement dimensions of the latent explanatory constructs. The SmartPLS software was adopted due to the unique features that allow for unobserved heterogeneity through the finite mixture routine technique (Sarstedt and Ringle, 2010; Ringle et al., 2010). The latent variables' reliability and validity were examined to assess the

measurement model. This study measured the internal consistency reliability using composite reliability, whereas indicator reliability was assessed through the outer loadings. According to Hair et al. (2017), the convergent validity, which explains the degree of agreement between two or more indicators of the same latent variable, was evaluated by examining the average variance extracted (AVE). Hairs et. al. (2011) suggested that AVE should be above 0.5 thresholds exhibited by all the latent variables included in the model. All the latent variables' composite reliability surpassed the recommended threshold of 0.7 (Gefen et al., 2000). Table 3 shows the indicators loading, indicator reliability, composite reliability, and AVE. To evaluate the discriminant validity, Vinzi et. al. (2010) suggested that it must explain at least 50% of the constructs' variance. It was further argued that AVE's value when square rooted should be greater than the level of the inter-correlations of the constructs with other constructs in the research model (Chin, 2010). Therefore, it could be concluded that the measurement model was acceptable and offered evidence that it was sufficient concerning its reliability, composite reliability, and discriminant validity. Table 3 indicates the latent variables and the composite reliability of the computed indicators.

**Table 4: Results Summary for Reflective Outer Models**

Latent Variable	Indicators	Loadings	Indicators Reliability	Composite Reliability	AVE	P-values	Cronbachs Alpha
LiveCom	LC13	0.7877	0.6205	0.8577	0.6016		0.7785
	LC14	0.7300	0.5329				
	LC15	0.7644	0.5843				
	LC16	0.8177	0.6686				
Place-Making	PL 4	0.7714	0.5951	0.9074	0.6206		0.8779
	PL 5	0.8116	0.6587				
	PL 6	0.8267	0.6834				
	PL 7	0.7372	0.5435				
	PL 8	0.7951	0.6322				
UrbanLiv	UL 1	0.8382	0.7026	0.7913	0.5601		0.6174
	UL 2	0.7060	0.4984				
	UL 3	0.6925	0.4796				

The analysis shows that the AVE for Liveable communities is 0.6016. Placemaking/Shaping is 0.6206, and Urban Liveability is 0.5601, which all agrees with Bagozzi and Youjjae (1988) stipulates that for AVE to be significant, it must be above 0.5. The model construct's indicator loadings also show that they are all significant. They all measured above 0.7; the composite reliability for the liveable community is 0.8577, Place-making is 0.9074, and Urban Liveability is 0.7913, prescribed by Ringle et al. (2015). The Cronbach's Alpha which is the internal reliability value for the three constructs of the model were also computed. It shows that Liveable communities have a Cronbach's Alpha of 0.7785, Place-making

0.8779, and Urban Liveability is 0.6174. All these agree with Leby and Hashim's (2010) established literature, which stipulated a 0.07 Alpha value to be a significant difference in the model constructs' internal reliability. All these values and computations are shown in Table 4, indicating all the stated variables and outcomes for Urban Liveability analysis from liveable communities and Place-making.

Table 5: Fornell-Larcker Criterion Analysis for Checking Discriminant Validity indicates that Liveable communities have discriminant validity of 0.7756, Placemaking is 0.7878, and Urban Liveability is 0.7484, which are all significant according to the study by Heirs et al. (2017). This analysis shows that the various liveable communities, place-making, and the resultant urban liveability are observed to have significant discriminant validity above 0.7 as established in the literature.

**Table 5: Fornell-Larcker Criterion Analysis for Checking Discriminant Validity**

	LiveCom	Place-Making	UrbanLiv
LiveCom	0.7756		
Place-Making	0.2865	0.7878	
UrbanLiv	0.6865	0.223	0.7484

**Structural model**

To assess the structural model in PLS-SEM, this study examined the path coefficients, their significance and variance explained (R2). The assessed values for path associations in the structural model were estimated in terms of sign and magnitude (Parveen et al., 2016). As established in the Literature, R2 values of the endogenous construct assess the predictive strength of a structural model; thus, if the R2 value ranges from 0.35 to above 0.67, it is said to be substantial, 0.33 is moderate, while 0.19 is small or weak for endogenous latent variables in the inner path model, as stated by Ringle et al. (2015).

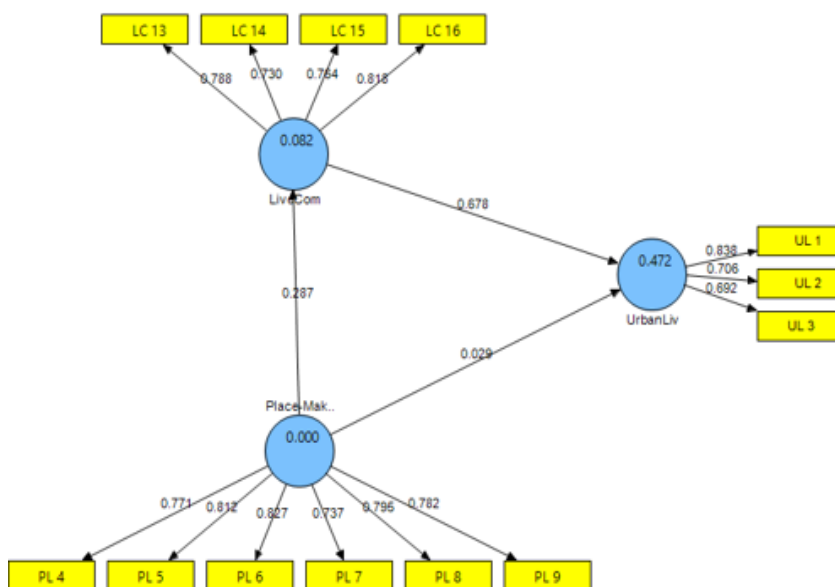

Figure II: the model's path coefficient

Source: Authors SmartPLS Test Analysis

Figure II shows the R2 value of Liveable Communities as 0.5970. Place-making is 0.6204, and the R2 values of Urban Liveability are 0.5938, which are all considered substantial. The effect Size F2 and predictive relevance Q2 and q2 were also computed. The bootstrapping was used to examine the significance of the paths and test the model's hypotheses, as shown in Figure III.

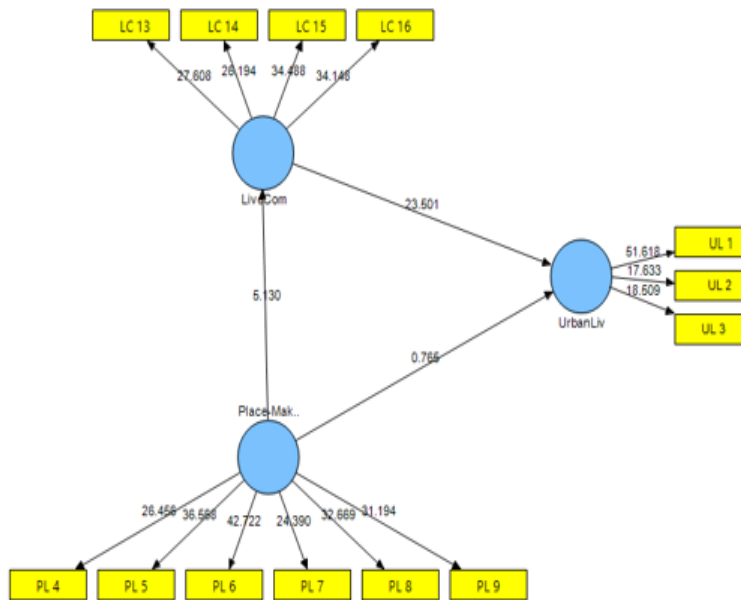

Figure III: The structural model

Source: Authors SmartPLS Test Analysis

Therefore, to test the significance of the hypothesised relationship, bootstrapping was applied. The bootstrapping procedure provides the t-values, which indicates whether the corresponding path coefficient is significantly different from zero (Hairs, 2020). According to Oyewobi (2014), if the t-values are above 1.65, this indicates that the path coefficient is significant at  $p \# 0.10$ . If the t-values are more significant than 1.96, the path coefficient is significant at the  $p \# 0.05$  significance level, and when the critical t-value is above 2.57, it can be said to be significant at  $p \# 0.01$ . Also, the computation of the effect size F2 of the model was computed using the formula in Equation (1)

$$f^2 = \frac{R^2_{\text{included}} - R^2_{\text{excluded}}}{1 - R^2_{\text{excluded}}} \quad (1)$$

1-R2 excluded

The effect Size F2 for Place-making is 0.011. To further evaluate the predictive significance of the structural models, the SmartPLS blindfolding procedure was used to calculate Q2. The Q2, according to Sarstedt et al. (2014), is based on the blindfolding procedure that allows for the omission of a certain part of the data matrix, which then calculates the model variables to predict the excluded part using the previously calculated estimates. However, Rigdon (2014) and Sarstedt et al. (2014) viewed Q2 as a measure of out-of-sample prediction, where Sarstedt et al. (2014) suggested that the lesser the difference between original and predicted

values, the higher the Q2 and the greater the predictive relevance of the model. In assessing the model presented here, the Q2 was calculated by omitting the distance of seven, which generated both cross-validated redundancy (CV Red.) and cross-validated communality (CV Com.) for the three constructs. However, cross-validated redundancy was suggested as the best approach (Hair et al., 2014). Therefore, for Place-making, endogenous construct (CV Red: 0.598; CV Com: 0.598); for Liveable Communities, (CV Red: 0.290; CV Com: 0.660) and Urban Liveability (CV Red: 0.307; CV Com: 0.674) were suggested. The values for all the endogenous constructs were above zero. As a rule of thumb, a Q2 value higher than zero for a specific endogenous construct shows that the path model's predictive accuracy is acceptable for that construct. Evaluating from Sarstedt et al. (2014), the coefficient sizes, relevance, and significance of the relationships depicted by the structural model were examined.

## DISCUSSION

This paper addressed the analytical nexus of liveable communities, Placemaking, and Urban Liveability across African Cities. This study established a conceptual framework that was empirically evaluated using PLS-SEM. The results of this study showed that Liveable Communities have a significant positive relationship with Urban Liveability. There is a significant positive relationship between liveable communities and urban liveability when place-making is a redundant variable. The research further shows that a significant positive relationship exists between place-making and liveable communities when urban liveability is a redundant value. These findings align with the previous results stated by Iyanda et al. (2018). The finding is also corroborated by Adewale et al. (2013), who posited that Place-making positive effect using liveable communities on Urban Liveability existed. This, according to Iyanda et al. (2018), means that the use of place-making as a measurement yardstick has enabled cities to strengthen the level of liveable community that can be achieved with a corresponding increase in overall urban liveability.

**Table 6: Path coefficient and hypothesis testing**

Path relationship	Hypothesis	Path coefficient	T Statistics	P-values	Remark
LiveCom -> UrbanLiv	H1: There is a positive relationship between liveable Communities and Urban Liveability	0.6782	23.1020	0.000	Supported
Place-Making -> LiveCom	H2: There is a positive relationship between placemaking and liveable communities	0.2865	5.4602	0.000	Supported
Place-Making -> UrbanLiv	H3: There exists a positive relationship between Placemaking and Urban Liveability	0.0287	0.7887	0.000	Supported

Three hypotheses were set, and the model's path coefficient, as shown in Figure 2, and the T-statistics in the structural model shown in Figure 3. The analysis shows a significant positive relationship between liveable communities and urban liveability as the path coefficient is 0.0.682, which is greater than the P-value set at 0.000. The T-statistics for the liveable communities and urban liveability is 23.1020, which is also above the P-Value of 0.000. This supports the hypothesis that a significant positive relationship exists between Liveable Communities and Urban Liveability within African Cities. The study also shows that the hypothesis set indicates a significant positive relationship between Place-making and Liveable Communities was supported as the calculated value of 5.4602 is greater than the P-value=0.000. These and the other hypotheses are shown in Table 6.

### **Implication**

There are a lot of theoretical and practical implications for academics and practitioners in this study. In the first place, this study represented a conceptual linkage within urban liveability, liveable communities, and place-making within African Cities. A deficiency of literature considers urban liveability applying the partial least square structural equation modelling to determine the correlation between liveability indicators. This paper addressed the intricate linkages within, Liveable communities (LC), Urban Liveability, and Place-Making (PL) to understand the theory better. These were viewed from the strength of three theoretical points: UL, LC, and PL. Although the adoption and application of Placa-making as a measure of Urban Liveability has received considerable attention from researchers in city development, the same attention is lacking in the analytical nexus of within Urban Liveability (UL), Placemaking (PL), and Liveable communities (LC) research.

Most of the previous studies have focussed more on communities and neighbourhoods. However, this study deals with a cross-evaluation of a broader spectrum of cities across Africa that were reached by administering online google survey questionnaires administered through the author's various contacts across higher learning institutions with the African Continent employing a Snowball and purposive sampling technique. This research also presented a conceptual framework tested to establish the various relationships within the two indicators (place-making and liveable communities) on urban liveability within the city space. City development experts could leverage urban liveability from liveable communities and place-making as the indicators. It is believed that the study presented in this paper will provide a reasonable basis for further work by academics on how place-making and liveable communities could have an impact on liveability in urban spaces when practical place-making efforts are put in place.

### **Limitations of Study**

The respondents surveyed and sampled carried the City's opinions they have lived in or currently reside without an in-depth knowledge of other cities across the continent of Africa, which may not represent a general view of residents in cities across Africa. This potential weakness in survey research will be addressed in future research using the multi-case research approach to triangulate the primary data and provide an opportunity for further exploration of relevant issues. Secondly, this research used cross-sectional data to investigate urban liveability's effect, placemaking on liveable communities in Africa. However, we recognised that the impact was complex; longitudinal data for future studies are encouraged.

## CONCLUSION

This study revealed the lines of connections within Place-making, Liveable communities, and Urban Liveability and also identified latent variables that could boost the cities 'liveable spaces' future. This study, therefore, provided a tested conceptual structure. PLS-SEM was used to evaluate the hypothesised paths. The findings showed support for the formulated hypotheses. This study showed that Urban Liveability, Placemaking, and liveable communities are analytically linked. The study also revealed that residents believe that placemaking and Liveable Communities can influence the overall liveability within the City Space in Africa.

Nevertheless, in the mainstream spatial urban study, the use and implementation of Liveable communities through place-making have gained some measure of significance. However, the overall linkages of liveable communities and place-making and their overall effect on urban liveability lack the same consideration. Consequently, striving to improve residents' liveability within the city space requires that liveable communities are established through practical Place-making endeavours and are still fussy and unpopular amongst city development planners. Most previous studies were more centred on using quality of life as an indicator of urban liveability with little effort to strengthen the links between Place-making and liveable communities.

## REFERENCES

- AAVV (2017). Health and Urban Design. *Urban Design Group Journal*, 142, 12–39.
- Adah, B. A., & Abasilim, U. D. (2015). Development and Its challenges in Nigeria: A theoretical discourse. *Mediterranean Journal of social sciences*, 6(6), 275–261.
- Alderton, A., Davern, M., Nitvimol, K., Butterworth, I., Higgs, C., Ryan, E., & Badland, H. (2019) What is the meaning of urban liveability for a city in a low-to-middle-income country? Contextualising liveability for Bangkok, Thailand. *Glob Health* 15:51. (2019). <https://doi.org/10.1186/s12992-019-0484-8>
- American Planning Association (2021). *Creative Placemaking*.
- Appleton, T. I. N. A., Clifton, R. A. C. H. E. L., & Goldberg, S. U. S. A. N. (1975). The development of behavioural competence in infancy. *Review of child development research*, 4, 101-186.
- Asia-Pacific Economic Cooperation (APEC), 2015. Building better cities: competitive, sustainable and livable metropolises. In: *Eco Summit, Philippines*. Available at: [www.pwc.com/ape](http://www.pwc.com/ape)
- Aziz, N. A., & Hadi, A. S. (2007). Linking urban form to a liveable city. *Malaysian Journal of Environmental Management*, 8, 87-107.
- Badland, H., Roberts, R., Butterworth, I., & Giles-Corti, B. (2015). How liveable is Melbourne? Conceptualising and testing urban liveability indicators: Progress to date, Melbourne
- Beauregard, R. A. (1993). Representing urban decline: postwar cities as narrative objects. *Urban Affairs Quarterly*, 29(2), 187-202.
- Bielo, G. (2003). The opposite of MTV (C-Span 2's Book TV and Brian Lamb's Booknotes'). *NEW YORK TIMES BOOK REVIEW*, 4-4.



- Borup, T. (2016). Creative placemaking: Arts and culture as a partner in community revitalization. *Fundamentals of arts management*, (pp. 50-69). University of Massachusetts: USA.
- Bowen, T., Cicardi, M., Farkas, H., Bork, K., Longhurst, H. J., Zuraw, B., & Xiang, Z. Y. (2010). 2010 International consensus algorithm for the diagnosis, therapy and management of hereditary angioedema. *Allergy, Asthma & Clinical Immunology*, 6(1), 1-13.
- Burns, M. K., Appleton, J. J., & Stehouwer, J. D. (2005). Meta-analytic review of responsiveness-to-intervention research: Examining field-based and research-implemented models. *Journal of Psychoeducational Assessment*, 23(4), 381-394.
- Buys, L., Vine, D., & Miller, E. (2013). What makes inner city high density liveable? Insight from residents in Brisbane, Australia. *Environmental Management and Sustainable Development*, 2(1), 14-33.
- Carmona, M., Heath, T., Tiesdell, S., & Oc, T. (2010). *Public places, urban spaces: the dimensions of urban design*. Routledge.
- Casanova, J. (2007). Rethinking secularization: A global comparative perspective. In *Religion, globalization, and culture* (pp. 101-120). Brill.
- Chauvet, M., Kunstler, G., Roy, J., & Morin, X. (2017). Using a forest dynamics model to link community assembly processes and traits structure. *Functional Ecology*, 31(7), 1452-1461.
- Chiu, R. (2019). Liveable Cities/Urban Liveability. *The Wiley Blackwell Encyclopedia of Urban and Regional Studies*, 1-7.
- Cohen, D., & Crabtree, B. (2006). Semi-structured interviews. *Qualitative research guidelines project*, 2.
- Cresswell, T. (2014). *Place: an introduction*. John Wiley & Sons.
- Crowe, J. A., Harrison, A., & Hayes-Gill, B. R. (1995). The feasibility of long-term fetal heart rate monitoring in the home environment using maternal abdominal electrodes. *Physiological measurement*, 16(3), 195.
- David, A., & Melanie, W. (2013). *Wayward sons: The emerging gender gap in labor markets and education*. Third Way Report.
- Dempsey, N., & Burton, M. (2012). Defining place-keeping: The long-term management of public spaces. *Urban Forestry & Urban Greening*, 11(1), 11-20.
- Douglass, D. H., Pearson, B. D., & Singer, S. F. (2004). Altitude dependence of atmospheric temperature trends: Climate models versus observation. *Geophysical Research Letters*, 31(13).
- Douglass, M. (2002). From global intercity competition to cooperation for livable cities and economic resilience in Pacific Asia. *Environment and urbanization*, 14(1), 53-68.
- Eastaway, M. P., & Støa, E. (2004). Dimensions of housing and urban sustainability. *Journal of Housing and the Built Environment*, 1-5.
- Economist Intelligence Unit. (2019). The global liveability index 2019. Available via [https://www.eiu.com/public/topical\\_report.aspx?campaignid¼liveability2019](https://www.eiu.com/public/topical_report.aspx?campaignid¼liveability2019)
- Ellery, P. J., & Ellery, J. (2019). Strengthening community sense of place through placemaking. *Urban planning*, 4(2), 238-248.
- Foster-Carter, A. (1976). From Rostow to Gunder Frank: conflicting paradigms in the analysis of underdevelopment. *World Development*, 4(3), 167-180.

- Francis, M. (2016). The making of democratic streets. *Contesti. Città, territori, progetti*, (1-2), 192-213.
- Friedmann, J. (2010). Place and place-making in cities: A global perspective. *Planning Theory & Practice*, 11(2), 149-165.
- Gandy, M. (2004). Rethinking urban metabolism: water, space and the modern city. *City*, 8(3), 363-379.
- Ge, J., & Hokao, K. (2006). Research on residential lifestyles in Japanese cities from the viewpoints of residential preference, residential choice and residential satisfaction. *Landscape and urban planning*, 78(3), 165-178.
- Gefen, D., Straub, D., & Boudreau, M. C. (2000). Structural equation modeling and regression: Guidelines for research practice. *Communications of the association for information systems*, 4(1), 7.
- Gehl, J. & Matan, A., (2009). Two perspectives on public spaces. *Building Research & Information*, 37(1): pp. 106–109, <http://dx.doi.org/10.1080/09613210802519293>
- Gehl, J. (2010). *Cities For people*. Washington: Island Press.
- Girardet, H. (2004). The metabolism of cities. *The sustainable urban development reader*, 125-132.
- Groat, L. N., & Wang, D. (2013). *Architectural research methods*. John Wiley & Sons.
- Haarhoff, E., Beattie, L., & Dupuis, A. (2016). Does higher density housing enhance liveability? Case studies of housing intensification in Auckland. *Cogent Social Sciences*, 2(1), 1243289.
- Hagerman, C. (2007). Shaping neighborhoods and nature: Urban political ecologies of urban waterfront transformations in Portland, Oregon. *Cities*, 24(4), 285-297.
- Hair Jr, J. F. (2020). Next-generation prediction metrics for composite-based PLS-SEM. *Industrial Management & Data Systems*.
- Hair Jr, J. F., Matthews, L. M., Matthews, R. L., & Sarstedt, M. (2017). PLS-SEM or CB-SEM: updated guidelines on which method to use. *International Journal of Multivariate Data Analysis*, 1(2), 107-123.
- Hair Jr, J. F., Sarstedt, M., Hopkins, L., & Kuppelwieser, V. G. (2014). Partial least squares structural equation modeling (PLS-SEM): An emerging tool in business research. *European business review*.
- Hair, J. F., Ringle, C. M., & Sarstedt, M. (2011). PLS-SEM: Indeed a silver bullet. *Journal of Marketing theory and Practice*, 19(2), 139-152.
- Hashem, H., Abbas, Y. S., Akbar, H. A., & Nazgol, B. (2013). Comparison the concepts of sense of place and attachment to place in Architectural Studies. *Malaysia Journal of Society and Space*, 9(1), 107-117.
- Heath, Y., & Gifford, R. (2002). Extending the theory of planned behavior: Predicting the use of public transportation 1. *Journal of Applied Social Psychology*, 32(10), 2154-2189.,
- Heidegger, M. (1971). Building dwelling thinking. *Poetry, language, thought*, 154, 1-26.
- Henseler, J., & Fassott, G. (2010). Testing moderating effects in PLS path models: An illustration of available procedures. In *Handbook of partial least squares* (pp. 713-735). Springer, Berlin, Heidelberg.

- Henseler, J., Ringle, C. M., & Sinkovics, R. R. (2009). The use of partial least squares path modeling in international marketing. In *New challenges to international marketing*. Emerald Group Publishing Limited.
- Higgs, C., Badland, H., Simons, K., Knibbs, L., & Giles-Corti, B. (2019). The Urban Liveability Index: developing a policy-relevant urban liveability composite measure and evaluating transport mode choice associations. *International journal of health geographics*, 18(1), 1-25.
- Ho, K., & Douglass, M. (2008). Globalisation and liveable cities: Experiences in place-making in Pacific Asia. *International Development Planning Review* 30(3),199-213
- Hull, J. C., & White, A. D. (1994). Numerical procedures for implementing term structure models II: Two-factor models. *The Journal of Derivatives*, 2(2), 37-48.
- Ifeoma, O. N., Obinna, I. A., Ngowari, G. B., Ndubuisi, N. C., Ngozi, O. K. C., Louisa, N. U., & Naz, R. F. (2020). Perception of Illegal Migration And Sex Trafficking In Europe Among Younger Women Of Oredo Lga, Edo State, Nigeria: The Social Work And Ethical Considerations. *Advances in Social Sciences Research Journal*, 7(6), 557-573.
- Institute for Public Administration (2021). Place-Making. Delaware Department of Transportation: University of Delaware. Available at:
- International Experts for Research Enrichment and Knowledge Exchange (IEREK). (2016). Place-making is an innovative tool of urban planning. Available at: <https://www.ierек.com/news/index.php/2016/12/14/place-making-innovative-tool-urban-planning/#:~:text=Place%2Dmaking%20is%20a%20people,and%20their%20aspirations%20towards%20it.> [Accessed April 3, 2021]
- Ishenower, L., Urban, E., Zhang, X. L., Gill, A. T., Henage, T., Johnson, T. A., & Saffman, M. (2010). Demonstration of a neutral atom controlled-NOT quantum gate. *Physical review letters*, 104(1), 010503.
- Ish-Shalom, P. (2006). Theory gets real, and the case for a normative ethic: Rostow, Modernization Theory, and the Alliance for Progress. *International Studies Quarterly*, 50(2), 287-311.
- Iyanda, A. R., Ninan, O. D., Ajayi, A. O., & Anyabolu, O. G. (2018). Predicting Student Academic Performance in Computer Science Courses: A Comparison of Neural Network Models. *International Journal of Modern Education & Computer Science*, 10(6).
- Jacob, H. (1969). *Debtors in court: The consumption of government services*. Rand McNally.
- Jacobs, J. (1961). *The Death and Life of Great American Cities*, Random House, Inc, New York,
- Jhingan, S., Nojiri, S., Odintsov, S. D., Sami, M., Thongkool, I., & Zerbini, S. (2008). Phantom and non-phantom dark energy: The Cosmological relevance of non-locally corrected gravity. *Physics Letters B*, 663(5), 424-428.
- Kashef, M. (2016). Urban liveability across disciplinary and professional boundaries. *Frontiers of Architectural Research*, 5(2), 239-253.
- Kirby, E. M., & Appleyard, M. (1981). *Cereal development guide*. Cereal development guide.
- Kneeshaw, S. (November 7 2017). From Liveability to Lovability – The role of the placemaker in co-creating vibrant cities. Available at: <https://www.blog.urbact.eu/2017/11/from-liveability-to-lovability/> [Accessed April 3 2021]

- Kunstler, R. (1993). Serving the Homeless through Recreation Programs. Research Update. *Parks and Recreation*, 28(8), 18-22.
- Kyttä, M. et al. (2015). Urban happiness: context-sensitive study of the social sustainability of urban settings, *Environment and Planning B*, 43(1), 34–57.
- Leby, J. L., & Hashim, A. H. (2010). Liveability dimensions and attributes: Their relative importance in the eyes of neighbourhood residents. *Journal of construction in developing countries*, 15(1), 67-91.
- Lewandowska, A., & Szymańska, D. (2021). Ecologisation of Polish cities in the light of selected parameters of sustainable development. *Sustainable Cities and Society*, 64, 102538.
- Ley, A., & Newton, P. (2010). Creating and sustaining liveable cities. *Developing living cities: From analysis to action*, 191-230.
- Liang, X., Liu, Y., & Qiu, T. (2020). Livability Assessment of Urban Communities considering the Preferences of Different Age Groups, *Complexity*, vol. 2020, Article ID 8269274, 15 pages <https://doi.org/10.1155/2020/8269274>
- Lynch, K. (1960). *The Image of the city*. Cambridge: MIT Press.
- Madanipour, A. (2003). *Public and Private Spaces of the City*. London, New York: Routledge.
- Mahapatra, G. D. (2017). Neighborhood Planning: Approach in Improving Livability and Quality of the Life in the Cities. In *Understanding Built Environment* (pp. 47-53). Springer, Singapore.
- Mahmoudi, M., Ahmad, F., & Abbasi, B. (2015). Livable streets: The effects of physical problems on the quality and livability of Kuala Lumpur streets. *Cities*, 43, 104-114.
- Main, K., & Sandoval, G. (2015). Placemaking in a translocal receiving community: The relevance of place to identity and agency. *Urban Studies*, 52(1), 71-86.
- Malek, N. B. A., & Idris, Z. Z. (2016). Women's Informal Employment and Fertility Rate: A Concern On Population Growth. *PROCEEDINGS OF 3rd KANITA POSTGRADUATE*, 16, 360.
- McCay, L. (2017). Designing Mental Health into Cities, *Urban Design Group Journal*, 142, 25–27
- Montgomery, C. (2013). *Happy City*. London: Penguin.
- Montgomery, J. (1998). Making a City: Urbanity, Vitality and urban Design, *Journal of Urban Design*.
- National Research Council. 2002. Concept of Livability and Indicators. In *Community and Quality of Life: Data Needs for Informed Decision Making*. Washington, DC: The National Academies Press. doi: 10.17226/10262.
- Oehlers, A. (2006). A critique of ADB policies towards the Greater Mekong Sub-region. *Journal of Contemporary Asia*, 36(4), 464-478.
- Oliver, C., Licence, L., & Richards, C. (2017). Self-injurious behaviour in people with intellectual disability and autism spectrum disorder. *Current opinion in psychiatry*, 30(2), 97-101.
- Oyewobi, L. O. (2014). Modeling performance differentials in large construction organisations in South Africa.
- P.P.S., 2017. The place-making process. Retrieved from Project for Public Spaces: <https://www.pps.org>.

- Pacione, M. (1990). Urban liveability: a review. *Urban geography*, 11(1), 1-30.
- Parveen, F., Jaafar, N. I., & Ainin, S. (2016). Social media's impact on organizational performance and entrepreneurial orientation in organizations. *Management Decision*.
- Popoola, A., Olatunde, M., Magidimisha, H., Abiodun, A., Adeleye, B. and Chipungu, L. (2020). Urban Forced Evictions: Experiences in the Metropolitan City of Lagos, Nigeria. *Indonesian Journal of Geography*, 52(1), 112-127
- Porteous, J. D. (1977). *Environment & behavior: planning and everyday urban life*.
- Project for Public Spaces. (2007). What is Placemaking? Available at:
- Rasoolimanesh, S. M., Badarulzaman, N., & Jaafar, M. (2011). Achievement to sustainable urban development using city development strategies: a comparison between cities alliance and the World Bank definitions. *Journal of Sustainable Development*, 4(5), 151.
- Reinartz, W., Haenlein, M., & Henseler, J. (2009). An empirical comparison of the efficacy of covariance-based and variance-based SEM. *International Journal of research in Marketing*, 26(4), 332-344.
- Relph, E. (1976) *Place and Placelessness* (London, Pion).
- Relph, E. (2016). Placemaking (and the production of places): Origins. Placeness. Retrieved from <http://www.placeness.com/placemaking-and-theproduction-of-places-origins-and-early-development>
- Rigdon, E. E. (2014). Rethinking partial least squares path modeling: breaking chains and forging ahead. *Long Range Planning*, 47(3), 161-167.
- Rigdon, E. E., Ringle, C. M., & Sarstedt, M. (2010). Structural modeling of heterogeneous data with partial least squares. *Review of marketing research*.
- Ringle, C. M., Sarstedt, M., & Mooi, E. A. (2010). Response-based segmentation using finite mixture partial least squares. In *Data Mining* (pp. 19-49). Springer, Boston, MA.
- Ringle, C., Da Silva, D., & Bido, D. (2015). Structural equation modeling with the SmartPLS. Bido, D., da Silva, D., & Ringle, C.(2014). Structural Equation Modeling with the Smartpls. *Brazilian Journal Of Marketing*, 13(2).
- Sarstedt, M., Ringle, C. M., Henseler, J., & Hair, J. F. (2014). On the emancipation of PLS-SEM: A commentary on Rigdon (2012). *Long range planning*, 47(3), 154-160.
- Schlebusch, S. (2015). Planning for Sustainable Communities: Evaluating Place-Making Approaches. *Agriculture, Forestry and Fisheries*. Special Issue: Planning for Sustainable Communities: Green-Spaces in Rural Areas, 4(4-1), 59-72.
- Sepe, M. (2017). Placemaking, liveability and public spaces. Achieving sustainability through happy places. *The Journal of Public Space*, 2(4), 63-76.
- Shen, W., Xiao, W., & Wang, X. (2016). Passenger satisfaction evaluation model for Urban rail transit: A structural equation modeling based on partial least squares. *Transport Policy*, 46, 20-31.
- Simmel, G. (1903). The metropolis and mental life. *The urban sociology reader*, 23-31.
- Smit, W., Hancock, T., Kumaresen, J., Santos-Burgoa, C., Sánchez-Kobashi Meneses, R., & Friel, S. (2011) Toward a research and action agenda on urban planning/design and health equity in cities in low and middle-income countries. *J Urban Health* 88(5):875–885

- Smith, D. (1973). *The Geography of Social Well-Being in the United States*. New York: McGraw-Hill.
- Smith, T., Nelischer, M., & Perkins, N. (1997). Quality of an urban community: A framework for understanding the relationship between Quality and physical form. *Landscape and Urban Planning*, 39(2), 229–241.
- Smith, T., Nelischer, M., & Perkins, N. (1997). Quality of an urban community: A framework for understanding the relationship between Quality and physical form. *Landscape and Urban Planning*, 39(2), 229–241.
- Surowiec, S. M., Davies, M. G., Eberly, S. W., Rhodes, J. M., Illig, K. A., Shortell, C. K., & Green, R. M. (2005). Percutaneous angioplasty and stenting of the superficial femoral artery. *Journal of vascular surgery*, 41(2), 269-278.
- Tuan, Y. F. (1977). Experience and appreciation. In *Children, Nature, and the Urban Environment: Proceedings of a Symposium-Fair*; Gen. Tech. Rep. NE-30. Upper Darby, PA: US Department of Agriculture, Forest Service, Northeastern Forest Experiment Station. 1-5 (Vol. 30).
- Vinzi, V. E., Chin, W. W., Henseler, J., & Wang, H. (2010). *Handbook of partial least squares* (Vol. 201, No. 0). Berlin: Springer.
- Whyte, W. H. (1980). *The social life of small urban spaces*. Washington, DC: Conservation Foundation.
- Whyte, W. H. (1980). *The social life of small urban spaces*. Washington, DC: Conservation Foundation.
- Williams, J. P., & McBride, W. H. (2011). After the bomb drops: a new look at radiation-induced multiple organ dysfunction syndrome (MODS). *International journal of radiation biology*, 87(8), 851-868.
- Woolcock, G. (2009) 'Measuring up? Assessing the live- ability of Australian cities', state of Australian cities. National Conference, Promaco Conventions, Sydney
- World Bank. (2012). *World development report 2013: Jobs*. The World Bank.
- Wyckoff, M. (2014). Definition of placemaking: four different types. *Planning & Zoning News*, 32(3), 1 - 10.
- Zelinka, A., & Brennan, D. (2001). *SafeScape. Creating safer, more livable Communities through planning and design*.



## ANFIS MODEL OF THE UCS OF MODIFIED SOIL FOR CONSTRUCTION PURPOSES

Udeala, R. C.<sup>1</sup>, Onyelowe, K. C.<sup>2</sup>, Uranta, J. D. C.<sup>3</sup>, Keke, E. O.<sup>4</sup> and Alaneme, G. U.<sup>5</sup>

<sup>1,3</sup>*Department of Civil Engineering Technology, Federal Polytechnic Ukana, Akwa Ibom State, Nigeria*

<sup>2,5</sup>*Department of Civil Engineering, Michael Okpara University of Agriculture, Umudike, Nigeria*

<sup>4</sup>*Department of Mechanical Engineering Technology, Federal polytechnic Ukana, Akwa Ibom State, Nigeria*

Adaptive neuro-fuzzy inference system (ANFIS), which integrates both Takagi-Sugeno fuzzy logic and neural network principles and also captures their benefits in a single framework was deployed for the modelling of the unconfined compressive strength (UCS) of expansive clayey soil treated with hybrid binder (HB). The compaction properties, consistency limits and the HB were the predictors while UCS was the target in the evolutionary model. The advantages of artificial intelligence techniques deployment in geotechnical research is to deal with the complex challenges associated with effectiveness in the utilization of construction materials so as to achieve optimal assessment of geotechnical materials 'behaviour and sustainable engineering design. ANFIS model development was carried out with 35 data sets derived from the experimental responses with respect to varying proportions of HB treatment from 0% to 12%. 10 and 25 datasets were used for training and testing the network respectively. The UCS was the target response while the HB replacement ratio, compaction and consistency limits properties were the input variables of the developed model. The model evaluation results obtained using statistical tools showed mean absolute error (MAE) of 0.7196, root mean square error (RMSE) of 0.9004, mean square error (MSE) of 0.811, and coefficient of determination (CoD) value of 0.9992 for UCS response parameters. The results obtained indicate a very good performance in terms of prediction accuracy. This shows that ANFIS provides the flexibility in achieving sustainable geotechnical materials integration in the built environment.

Keywords: adaptive neuro fuzzy inference system(ANFIS), hybrid binder, soft computing, soil stabilization, unconfined compressive strength (UCS)

### INTRODUCTION

ANFIS modelling system is the learning and training of the network where the associated membership degrees are automatically adjusted using Neural Network

<sup>1</sup> richard.udeala@fedpolyukana.edu.ng

<sup>2</sup> kennedychibuzor@kiu.ac.ug; konyelowe@mouau.edu.ng

<sup>3</sup> urantacaptain@gmail.com

<sup>4</sup> kekeeverest@gmail.com

<sup>5</sup> tinz2020@gmail.com

(NN) capability, which removes the burden of manual adjustment of the membership function parameters. ANFIS is an artificial intelligence (AI) or soft computing modelling tool, which has become attractive and desirable due to a combination of linguistic variables transparency from the Fuzzy logic method and leaning capability of ANN techniques (Shahin et al. 2001). Through the utilization of the ANN's learning and generalization capability to update and process Takagi-Sugeno fuzzy inference System (FIS) type provides ANFIS with the learning ability similar to ANN through data training. It is able to process and model behaviour of complex system such as mixture experiments optimization. The results generated can therefore be mapped into FIS described in linguistic labels. Thus, the hidden layer and learning processing parameters are determined by FIS in the ANFIS network which removes the conventional challenges faced in ANN-modelling for the determination of hidden layer parameters and also the determination of membership function parameters and Fuzzy if-then rule generation in Fuzzy logic modelling. Its major advantages over complex mathematical model computations are not involved, it is rather robust, adaptive and perform data generation faster with higher efficiency Jang et al. 1997). In this work, the ANFIS learning techniques has been used to predict the UCS of a treated problematic soil.

Various kinds of soil are used for geotechnical engineered construction works and more of serious concerns are the problematic soils. Most commonly used soil deposits in their natural form support civil structures effectively without treatment while others require treatment in order to be suitable for construction works such as expansive clayey soil. These soils are expected to be removed and replaced with materials with better properties to avoid failure, or by the modification of its mechanical and swelling properties in order to improve its performance (Basma and Kallas, 2004; Dutta et al. 2019). Expansive soil tends to produce serious challenge when utilized for civil foundation works due to poor mechanical behaviour of the clay minerals composition, which makes them possess and display shrink-swell properties during drying and wetting cycles (Salahudeen et al. 2018). It tends to suddenly expand and swell when in contact with water and shrink when it losses moisture due to its physicochemical properties (Onyelowe et al. 2019a; K. C. Onyelowe et al. 2021a and 2021b). With the above characteristic features of problematic soil utilized as foundation materials, there has been a necessity to forecast the engineering properties associated with the erratic construction materials. This is to overcome the rigors or time needed to repeatedly visit the laboratories to obtain results needed for earthwork designs and construction.

## **MATERIALS AND METHODS**

### **Materials**

Clayey soil was obtained from a depth of 1 meter from a borrow pit located at Ngoro Oboro, Abia State. It was observed as smaller fragments in broken form, it was thus air dried, pulverised and as well sieved with BS sieve No. 4 (4.75mm aperture). It was prepared in accordance with British Standard International BS1377 (1990) and stored for the laboratory work at room temperature. And the treated soil was prepared in accordance with British Standard International BS1924 (1990). Rice husk ash utilized as the stabilizing agent was gotten by the direct combustion of rice husk collected from rice mills in Abakaliki, Nigeria in a controlled incineration system to avoid air pollution (K. C. Onyelowe et al. 2019; K. C.



Onyelowe et al. 2020). The ash samples obtained according to relevant literature, satisfies the requirements of a pozzolanic material in accordance with British Standard International BS 8615-1 (2019) and American Standard for Testing and Materials ASTM C618 (1978) due to the presence of  $Al_2O_3$ ,  $SiO_2$  and  $Fe_2O_3$  in its chemical oxides 'composition. The release of alumina-silica from the activated rice husk ash enables pozzolanic reaction in the clayey soil adsorbed complex interface through calcination and hydration to achieve stabilization of the problematic soil (Attah et al. 2020). Hydrated-Lime ( $Ca(OH)_2$ ) is quicklime chemically combined with 33-34% magnesium oxide (MgO), 46-48% (CaO), and 15-17% chemically combined water. Its density is less than that of quicklime at  $3.34g/cm^3$  because it's in more aqueous condition, which created pores in the structure of the solid; and also caustic possessing a pH of 12.8 and pozzolanic behavior. This makes it a good supplementary or alternative binder for earth works construction. It meets the standard conditions stipulated in the appropriate design codes (Alaneme et al. 2020).

By mixing 5% of hydrated lime by weight of RHA with the ash under laboratory conditions, the hydrated-lime activated rice husk ash (HARHA) used for the stabilization process was achieved.

## Methods

Laboratory experiments were carried out on the collected test material samples so as to derive its general engineering behavior namely; sieve analysis test, compaction test, Atterberg limits test, California bearing ratio and specific gravity of soil test to enable the characterization of the representative RHA and problematic soil. Following the required laboratory conditions in accordance with the British Standard International BS1377 (1990), these basic tests were conducted. RHA was then activated with the three compounds of calcium in accordance with the requirements of Davidovits (Segad et al. 2010). The rice husk ash mixture was thus activated with caustic solution of  $Ca(OH)_2$  (5% by weight of RHA), it was then used in blending with ratios of 0% (the control test), to 12% by weight of soil to improve the expansive clayey soil mechanical, swelling and compaction behavior. Atterberg limits (plastic limit and liquid limit) behavior of problematic clayey soil blended with quicklime activated RHA were observed by experimentation using the Casagrande apparatus in accordance with design standard. From the observed test results, the plasticity index ( $I_p$ ) and activity of clay was computed.

### *Unconfined compressive strength (UCS)*

UCS test involves a cylinder of soil without lateral support is tested to determine failure stress in axial compression, at a constant rate of stream. The compressive force per unit cross-sectional area which is required to fail the test soil specimen is called unconfirmed compressive strength of the soil in accordance with BS 1377 (1990). The test was also carried out with respect to varying proportions of HARHA-soil blend from 0% to 12% and the test soil mixtures were compacted using BSL and cured for seven days. The test soil specimens were then placed inside the loading frame of the UCS testing machine after the curing exercise (Kalkan et al. 2009; Onyelowe, 2017).

**ANFIS modelling algorithm flow chart**

After derivation of results from the laboratory, the data generated are logically sorted so as to obtain the model variables. The data base for the model development are divided into two parts for training and testing of the ANFIS network with 70% and 30% allotted respectively. The research study flowchart is presented in Fig. 1 showing the sequential flow of events, training, testing and ANFIS model validation using statistical computational technique. The loss function parameters namely; Root mean square error (RMSE), mean square error (MSE) and coefficient of determination (R2) were utilized for performance evaluation of the ANFIS model Wang and Rahman, 2002).

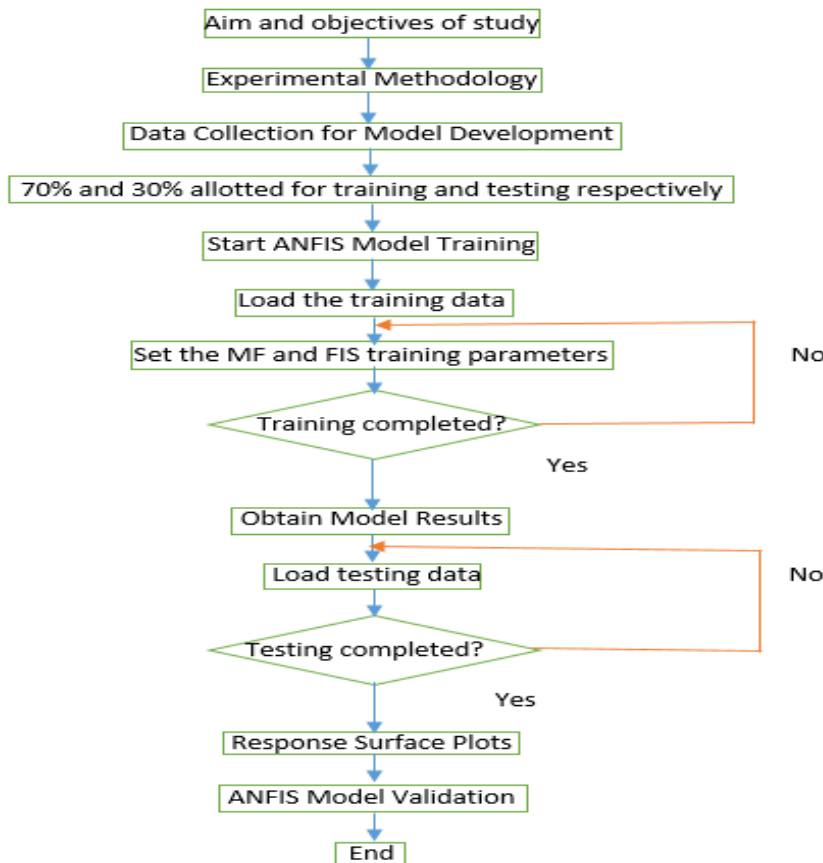

Fig. 1: Research Study Flowchart

**Data base for ANFIS model development**

The data generated from experimental laboratory results, relevant literature and expert knowledge, from which investigates the compaction, consistency limits and mechanical strength properties of treated expansive clayey soil with respect to varying ratio of replacement partially by HARHA from 0 % to 12 % (Onyelowe et al. 2019b). The ANFIS network’s input parameters constitute the replacement ratio by HARHA, the Atterberg limits and compaction properties of the soil mixture combinations, while the output variable of the network is the unconfined compressive strength (UCS) of the stabilized soil.

The descriptive statistics of the experimental results generated from the laboratory tests which was further utilized for ANFIS model development are presented in Table 1.

**Table 1. Descriptive Statistical of data sets used for training and testing the ANFIS Network**

Variables	Mean	Standard Error	Standard Deviation	Sample Variance	Range	Minimum	Maximum
Soil (%)	94.000	0.736	3.680	13.542	12	88	100
HARHA (%)	6.000	0.736	3.680	13.542	12	0	12
Liquid Limit (WL) (%)	47.900	2.419	12.097	146.333	39	27	66
Plastic Limit (WP) (%)	17.160	0.512	2.561	6.557	8	13	21
OMC (%)	17.964	0.171	0.853	0.728	3	16	19
MDD (g/cm <sup>3</sup> )	1.683	0.050	0.252	0.064	0.74	1.25	1.99
CBR (%)	24.068	2.421	12.105	146.526	36	8	44
UCS (kN/m <sup>2</sup> )	172.720	6.535	32.677	1067.793	105	125	230

## ANFIS MODEL DEVELOPMENT AND RESULT DISCUSSION

### Materials characterization

From preliminary results, it was deduced that the clayey soil sample possesses 45% of its particles passing sieve size 0.075mm, with a natural moisture content of 14% and liquid limit of 66%. Based on the derived experimental results, the soil specimen was further classified using AASHTO classification as A-7-6 soil and poorly graded with high clay content (CH) according to USC system. Furthermore, the plasticity index of 45% indicates a highly plastic soil which breaks easily upon the load application and that the representative clayey soil also has a swelling potential property, with a plastic limit of 21% and this means that the soil is highly expansive. The maximum dry density of the soil was observed to be 1.25g/cm<sup>3</sup> at an optimum moisture content value of 16%. These properties have characterized the clayey soil as a high expansive and problematic soil which is very unsuitable for civil construction works (Salahudeen et al. 2020; Segui et al. 2013).

The chemical oxides composition of the representative test clayey soil and the rice husk ash indicates that the soil has high oxide composition (34.33%) of Na<sub>2</sub>O, 18.09% of Al<sub>2</sub>O<sub>3</sub> and 12.45% of SiO<sub>2</sub> by the test soil sample's weight. These elemental oxides contribute to the expansive condition of the soil. The ferrite composition shows its rich in the red color of the clayey soil and plays active role during pozzolanic reaction. This property supports the high swelling potential of the clayey soil. However, RHA has high alumina-silicates content, which fulfills the minimum requirements of pozzolanic materials in accordance with specified design standards and previous studies (ASTM C618, 1978; Herve et al. 2009; Onyelowe et al. 2019c).

### *Experimental responses of clayey soil modified with calcined rice husk ash*

The incorporation of chemical additive (HARHA) for mechanical properties modification of problematic expansive clayey soil was evaluated in this study to improve its engineering performance for civil construction purposes. From the obtained laboratory results presented in Fig. 2, the soil's Atterberg limits properties reduced with higher percentage addition of HARHA. Moreover, for the compaction test of the, the OMC for the control mix is 16% and the moisture content result

increased to maximum limit of 19% at 4% replacement while the OMC results decreased subsequently, slightly at further addition of HARHA to 17% at 12% replacement by HARHA. However, MDD results increased linearly as HARHA addition increased from 1.25g/cm<sup>3</sup> for the control to maximum value of 1.95g/cm<sup>3</sup> at 12% replacement by HARHA. Moreover, from the mechanical strength properties of the blended soil namely; California bearing ratio (CBR) and unconfined compressive test (UCS) increased from 8% and 125kN/m<sup>2</sup> respectively at control mix to 40% and 230kN/m<sup>2</sup> for CBR and UCS respectively at 11% replacement. This mechanical strength improvement is achieved due to binding effect of the hydrated lime and alumina-silicates from the blended rice husk ash (Onyelowe et al. 2019c; Louafi et al. 2015).

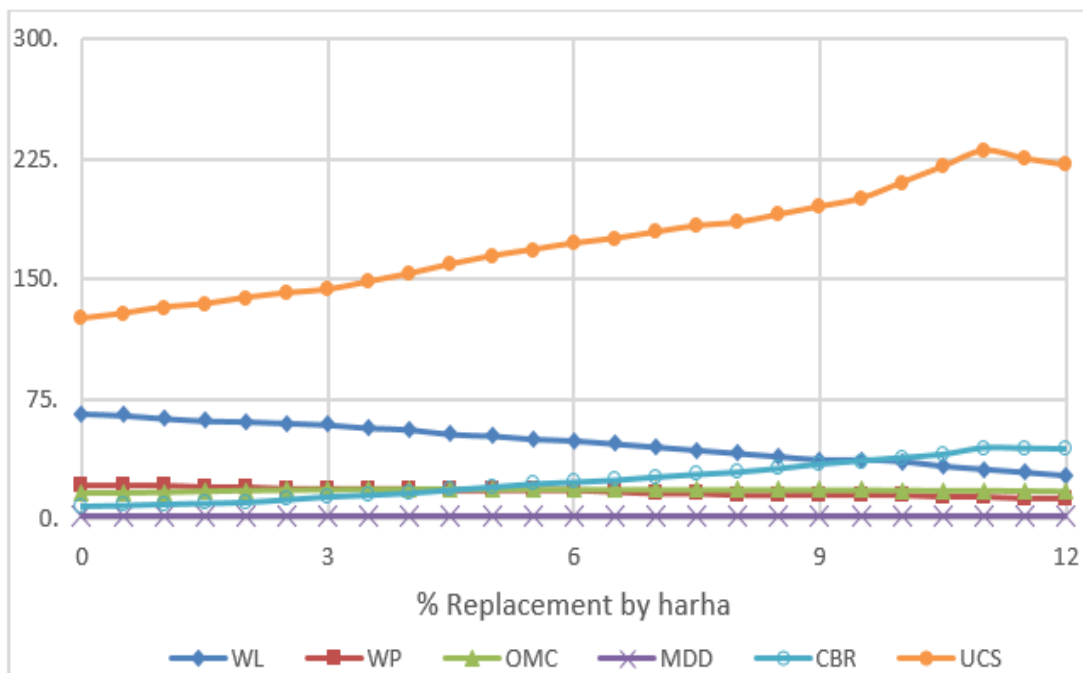

Fig. 2: Graphical Plot of Experimental Results

### ANFIS model development

Data obtained from relevant literatures and expert judgement were utilized for appropriate model input-output pattern structure formulation; the input parameters of the ANFIS network were the soils 'replacement ratio by HARHA, compaction and consistency limits characteristics while the output variables was the mechanical strength property of the treated soil sample (UCS). The network architecture is presented in Fig. 3 showing the model variables and processing parameters of the network (Ghorbani and Hasanzadehshooilli, 2018).

Using ANFIS toolbox in MATLAB software for the model simulation, testing training and validation, the data sets was loaded from the workspace, and using sub clustering method of fuzzy inference system (FIS) generation which is very suitable for multiple inputs complex systems. Furthermore, hybrid optimization method was utilized for training of FIS at 100 epochs. For Sub clustering membership function generation, the following parameters were selected as presented in Table 5.

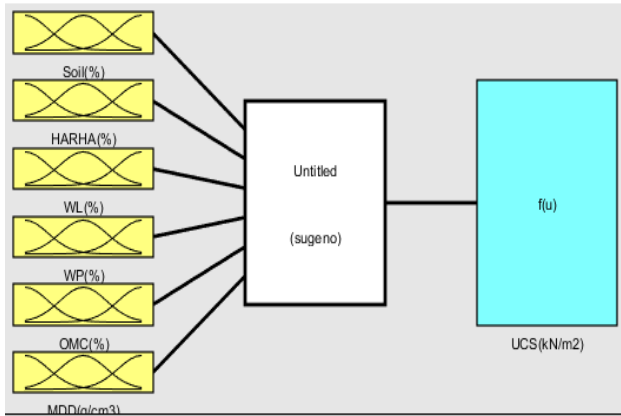

Fig. 3: ANFIS Model Variables

**Training and testing of the ANFIS network**

As the ANFIS network is fed the datasets, appropriate FIS parameters and hybrid training methods were then selected. The loaded datasets for the ANFIS network training, which possess 25 index numbers in the x-axis plotted against output variables at y-axis for UCS response is shown in Fig. 4.

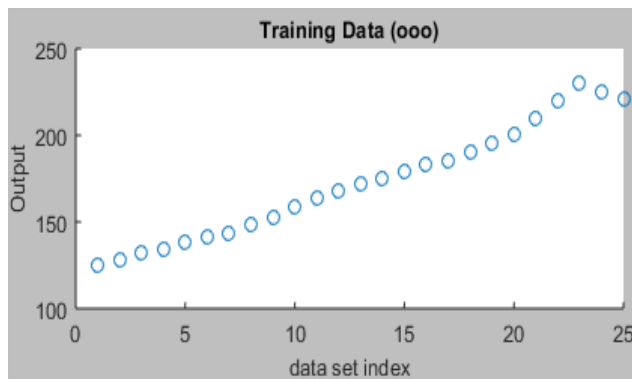

Fig. 4: ANFIS Training Datasets Plot

The ANFIS network was further trained after loading the datasets and setting the appropriate training and testing parameters. For the UCS response  $4.649 \times 10^{-3}$  was the obtained training error as shown in Fig. 5.

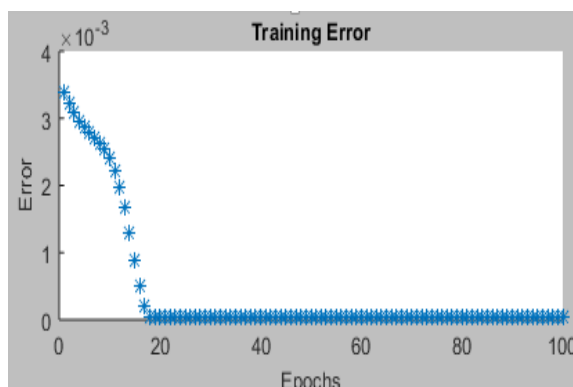

Fig. 5: ANFIS Training Error Plot

After training the network with the sorted datasets, the indexed points which were initially open circle now has a red asterisk inside the circle to show that the ANFIS network is trained with given sets of data as shown in Fig. 6.



Fig. 6: Training Data Plots

The testing data sets are then loaded from the workspace after end of ANFIS data training. 30% of the system data base is allotted for this stage as the remaining 70% was utilized for training of the network. The loaded testing datasets were plotted with the trained data sets in blue dotted color with 10 index points as shown in Fig. 7 for the UCS response (Rutkowski, 2004).

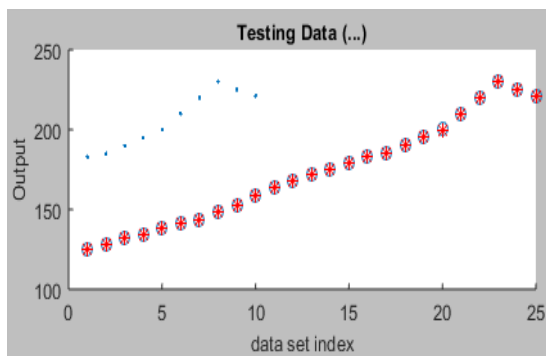

Fig. 7: ANFIS Training and Testing Datasets Plots

The network is further tested with the loaded testing datasets using the initially prescribed training and FIS parameters to ensure better model prediction performance. A testing error of was obtained for UCS response as shown in Fig. 8.

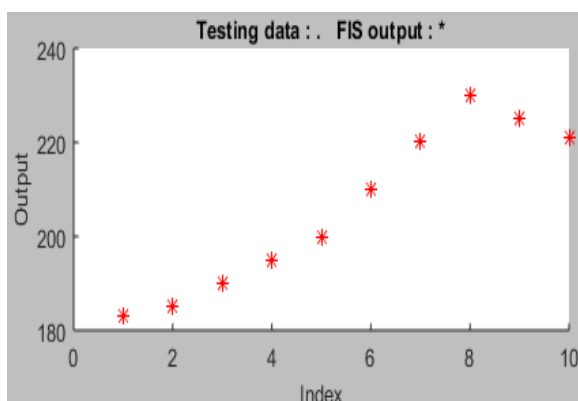

Fig. 8: Plotted Testing Data

***Developed ANFIS network architecture***

The developed ANFIS architecture after training and testing with the datasets fed to the network is shown in Fig. 9. Showing the complex connections of the input variables, the fuzzification node, the inputs weight signals aggregations, network firing strength normalization, fuzzy if-then rule automatic generation and output

nodes overall summation function. The architecture clearly shows that we have six input variables namely effective soil proportion (%), HARHA replacement ratio (%), liquid limit (%), plastic limit (%), optimum moisture content (%) and maximum dry density (g/cm<sup>3</sup>) with one output parameter the UCS (kN/m<sup>3</sup>) (Ceylan et al. 2010).

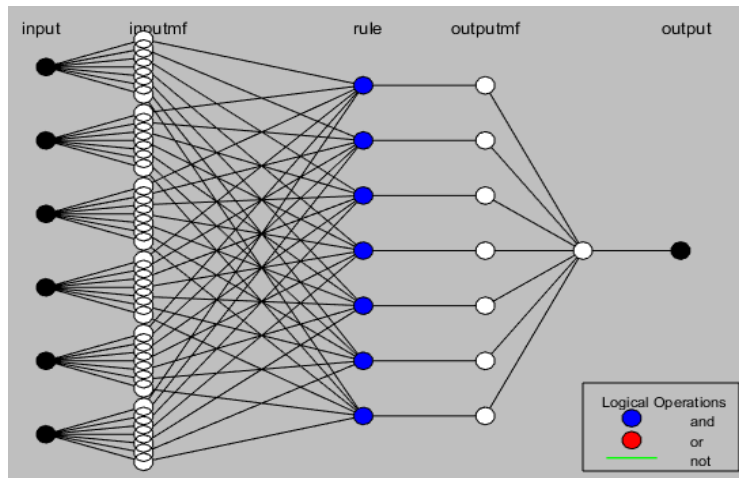

Fig. 9: ANFIS Network Architecture

**Graphical expression of ANFIS model variables relationships**

The ANFIS network learns the generalization of data sets fed to it using hybrid learning method, and is able to map a given input space with the corresponding output response. The network variables 'relationships can be assessed through 3D-surface plot after testing and training of the ANFIS network as shown in Fig. 10. The effects of clayey soil replacement by HARHA, its Atterberg limits and compaction properties in respect to UCS response were observed (Erdirencelebi and Yalpir, 2011).

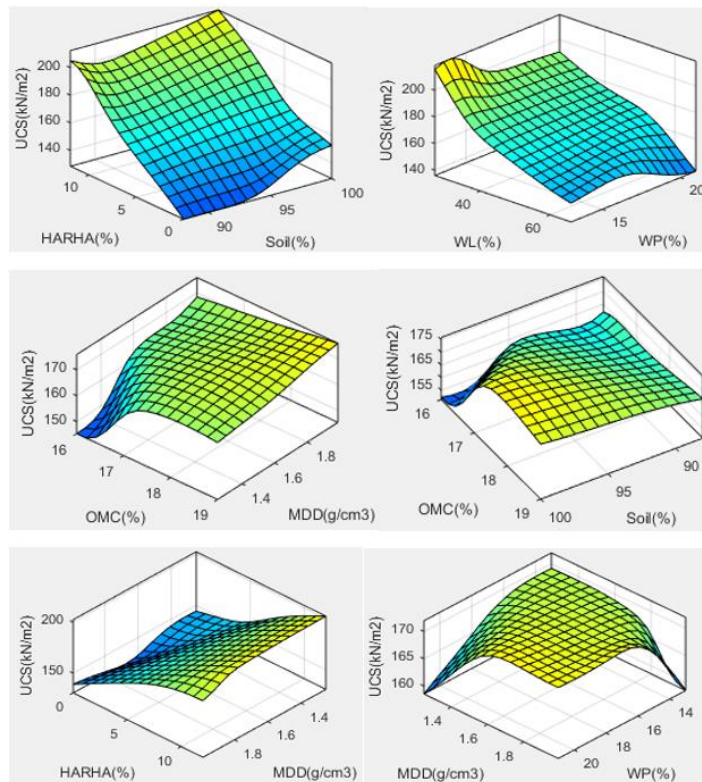

Fig. 10: ANFIS Model Variables 'Surface Plots

### Model validation

For optimization of the given laboratory response values, the training and testing datasets were fed into the ANFIS model for mechanical behavior prediction of the soil-additive blend. After development of the model, the experimental or actual results were statistically compared with the ANFIS model results using loss function parameters RMSE, MSE, MAE, and also coefficient of determination so as to rate the prediction accuracy performance of the developed ANFIS model. The statistical computation was carried out with Microsoft Excel software and the results are presented in Table 2. The obtained statistical results indicate existence of no significant difference between the actual values and the ANFIS model results with MAE of 0.7196, RMSE of 0.9004, MSE of 0.811, and coefficient of determination value of 0.9992 for the UCS response parameters (Kim and Heeyoung, 2016; Colin and Windmeijer, 1997).

**Table 2: ANFIS model performance evaluation**

Response Variable	Statistical Parameter	Requirements	Computed Results	Remarks
UCS	MAE	To be close to 0	0.7196	Satisfactory
	RMSE	To be close to 0	0.900362	Satisfactory
	MSE	To be close to 0	0.810652	Good
	r-sq	> 0.8	0.9992	Excellent

From the computed results which provide sufficient assessment of the developed ANFIS model performance showing satisfactory results as compared with model performance result obtained by (Alby and Shivakumar, 2018; Sobhani et al. 2010). The slope of the regression line of ANFIS model results vs. actual results is presented in Fig. 11. The plot shows the steepness of the line of fit which is the straight line that best predicts the provided sets of data. The line of fit equation for the output variable namely, UCS is presented in Eq. 1.

$$y = 0.9939x + 1.0999 \quad (1)$$

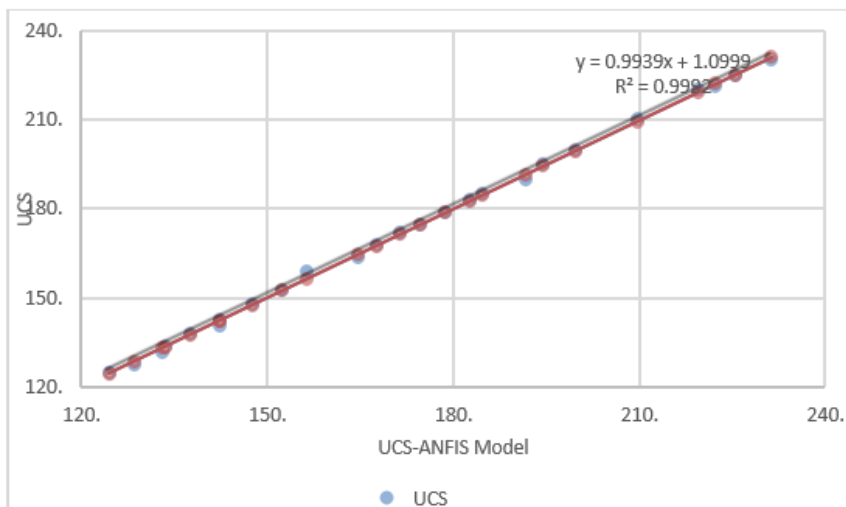

Fig. 11: UCS-ANFIS Model Line of Fitness Plot  
Where y is the UCS and x is the varying proportions of HARHA.



## CONCLUSION

Soft computing technique method known as ANFIS was adapted for the modelling of the compaction, consistency limits and mechanical properties of expansive clay soil treated with HARHA from 0 % to 12 % replacement ratio. The following conclusions can be drawn from the research study;

The preliminary soil's test indicated a poorly graded, expansive clayey soil, which is classified as CH according to unified soil classification system; these properties fall off the required specification as a construction material. However, the incorporation of HARHA enhanced the problematic soil's mechanical behavior making it suitable for engineering purposes.

Moreover, the obtained experimental responses were utilized as the system data base for ANFIS model development which provides a better assessment of the problematic clayey soil-HARHA blend deformation and mechanical strength behavior. In order to achieve testing and training of the ANFIS network, the system datasets were divided into two with the former and later receiving 30% and 70% respectively.

Furthermore, the developed ANFIS model performance in terms of accuracy of prediction were evaluated using loss function parameters RMSE, MSE, MAE, and also coefficient of determination (R<sup>2</sup>). The ANFIS model evaluation results indicate MAE of 0.7196, RMSE of 0.9004, MSE of 0.811, and coefficient of determination value of 0.9992 for UCS response parameters.

Finally, the deformation behavior of expansive clayey soil treated with HARHA were evaluated through model development using ANFIS soft computing method which has the capacity to deal with complex relationships among variables and predict the output parameters with good accuracy. The results obtained from this research show clearly the flexibility of ANFIS method application in soil-additive blend engineering behavior modelling for sustainable development.

## ABBREVIATIONS

1. ANFIS- Adaptive neuro-fuzzy inference system
2. HARHA-Hydrated Lime Activated Rice Husk Ash
3. MSE-Mean Square Error
4. RMSE-Root Mean Square Error
5. MAE = Mean Absolute Error
6. WL = Liquid Limit
7. WP = Plastic Limit
8. IP = Plasticity Index

## REFERENCES

- Alaneme, G. U., Onyelowe, K. C., Onyia, M. E., Bui Van, D., Mbadike, E. M., Ezugwu, C. N., Dimonyeka, M. U., Attah, I. C., Ogbonna, C., Abel, C., Ikpa, C. C., & Udousoro I. M. (2020). Modeling Volume Change Properties Of Hydrated-Lime Activated Rice Husk Ash (HARHA) Modified Soft Soil For Construction Purposes By Artificial Neural Network (ANN), *Umudike Journal of Engineering and Technology (UJET)*; Vol.6, No.1, June 2020, pp.88 – 110; [https://doi.org/10.33922/j.ujet\\_v6i1\\_9](https://doi.org/10.33922/j.ujet_v6i1_9)
- Alby, S. & Shivakumar, B. L. (2018). A prediction model for type 2 diabetes using adaptive neuro-fuzzy interface system. *Biomedical Research*, S69-S74. <http://dx.doi.org/10.4066/biomedicalresearch.29-17-254>
- ASTM specification C618 (1978). "Specification for fly ash and raw or calcined natural pozzolan for use as a mineral admixture in Portland Cement Concrete".
- Attah, I. C., Etim, R. K., Alaneme, G. U. et al. (2020). Optimization of mechanical properties of rice husk ash concrete using Scheffe's theory. *SN Appl. Sci.* 2, 928 (2020). <https://doi.org/10.1007/s42452-020-2727-y>
- Basma, A. A., & Kallas, N. (2004). Modeling soil collapse by artificial neural networks. *Geotech Geol Eng*; 22:427–38. doi:10.1023/B:GEGE.0000025044.72718.db.
- British Standard (BS) 1377 (1990). Method of testing soils for civil engineering purpose. British Standards Institution, London
- British Standard (BS) 1924 (1990). Method of testing for stabilized soils. British Standard Institution, London
- BS 8615-1 (2019). Specification for pozzolanic materials for use with Portland cement. Natural pozzolana and natural calcined pozzolana
- Ceylan, M., Arslan, M. H., Ceylan, R., Kaltakci, M. Y., & Ozbay, Y. (2010). A new application area of ANN and ANFIS: determination of earthquake load reduction factor of prefabricated industrial buildings. *Civ. Eng. Environ. Syst.*, 27, 53–69
- Colin, C. A., & Windmeijer F. A. G. (1997). An R-squared measure of goodness of fit for some common nonlinear regression models. *J Econom* 77(2):1790. [https://doi.org/10.1016/s03044076\(96\)01818-0](https://doi.org/10.1016/s03044076(96)01818-0)
- Dutta, R. K., Singh, A., & Gnananandarao, T. (2019). Prediction of Free Swell Index for the Expansive Soil Using Artificial Neural Networks', *Journal of Soft Computing in Civil Engineering* 3-1 47-62 <http://dx.doi.org/10.22115/SCCE>.
- Erdirencelebi, D., & Yalpir, S. (2011). Adaptive network fuzzy inference system modeling for the input selection and prediction of anaerobic digestion effluent quality. *Applied Mathematical Modelling*, 35: 3821-3832. doi: 10.1016/j.apm.2011.02.015
- Ghorbani, A., & Hasanzadehshooilli, H. (2018). Prediction of UCS and CBR of microsilica-lime stabilized sulfate silty sand using ANN and EPR models; application to the deep soil mixing. *Soils and Foundations*, 58: 34-49. <https://doi.org/10.1016/j.sandf.2017.11.002>
- Hervé P., Lyesse L., Tomasz H., & Liang B. H. (2009). Desiccation cracking of soils, *European Journal of Environmental and Civil Engineering*, 13:7-8, 869-888, <https://doi.org/10.1080/19648189.2009.9693159>
- Jang, J. S. R., & Sun, C. T. (1997). Mizutani E. *Neuro-fuzzy and soft computing, a computational approach to learning and machine intelligence*. Prentice Hall, 1997

- K. C. Onyelowe, D. Bui Van, O. Ubachukwu, C. Ezugwu, B. Salahudeen, M. Nguyen Van, C. Ikeagwuani, T. Amhadi, F. Sosa, W. Wu, Thinh Ta Duc, A. Eberemu, Tho Pham Duc, O. Barah, C. Ikpa, F. Orji, G. Alaneme, E. Amanamba, H. Ugwuanyi, Vishnu Sai, C. Kadurumba, S. Selvakumar & B. Ugorji (2019). Recycling and Reuse of Solid Wastes; a Hub for Ecofriendly, Ecoefficient and Sustainable Soil, Concrete, Wastewater and Pavement Reengineering. *International Journal of Low-Carbon Technologies*. Vol.14(3), pp. 440-451. <https://doi.org/10.1093/ijlct/Ctz028>
- K. C. Onyelowe, F. D. A. Onyelowe, D. Bui Van, C. Ikpa, A. B. Salahudeen, A. O. Eberemu, K. J. Osinubi, E. Onukwugha, A. O. Odumade, I. C. Chigbo, A. A. Amadi, E. Igboayaka, J. Obimba-Wogu, Z. Saing, & T. Amhadi, (2020). Valorization and sequestration of hydrogen gas from biomass combustion in solid waste incineration NaOH oxides of carbon entrapment model (SWI-NaOH-OCE Model). *Materials Science for Energy Technologies*, Vol. 3, Pp. 250-254. <https://doi.org/10.1016/j.mset.2019.11.003>
- K. C. Onyelowe, M. E. Onyia, D. Bui Van, A. A. Firoozi, O. A. Uche, S. Kumari, I. Oyagbola, T. Amhadi, & L. Dao-Phuc (2021a). Shrinkage Parameters of Modified Compacted Clayey Soil for Sustainable Earthworks. *Jurnal Kejuruteraan* 33(1): 137-144 [https://doi.org/10.17576/jkukm-2020-33\(1\)-13](https://doi.org/10.17576/jkukm-2020-33(1)-13)
- K. C. Onyelowe, M. E. Onyia, D. Nguyen-Thi, D. Bui Van, E. Onukwugha, H. Baykara, I. I. Obianyo, L. Dao-Phuc, & H. U. Ugwu (2021b). Swelling Potential of Clayey Soil Modified with Rice Husk Ash Activated by Calcination for Pavement Underlay by Plasticity Index Method (PIM). *Advances in Materials Science and Engineering*, Vol. 2021, Article ID 6688519, <https://doi.org/10.1155/2021/6688519>
- Kalkan, E., Akbulut, S., Tortum, A., & Celik, S. (2009): Prediction of the unconfined compressive strength of compacted granular soils by using inference systems. *Environ Geol.*, 58, 1429–1440.
- Kim, S., & Heeyoung, K. (2016). A new metric of absolute percentage error for intermittent demand forecasts. *International Journal of Forecasting*, 32(3):669–679 [doi:10.1016/j.ijforecast.2015.12.003](https://doi.org/10.1016/j.ijforecast.2015.12.003).
- Louafi, B., Hadeif, B., & Bahar, R. (2015). Improvement of geotechnical characteristics of clay soils using lime. *Advanced materials research*, vol. 1105. Trans Tech Publications, Zürich. pp 315–319
- Onyelowe, K. C., Alaneme, G., Igboayaka, C. F. Orji, H. Ugwuanyi, D. Bui Van, M., & Nguyen Van. (2019a). Scheffe optimization of swelling, California bearing ratio, compressive strength, and durability potentials of quarry dust stabilized soft clay soil, *Materials Science for Energy Technologies*, vol. 2(1), pp. 67-77. <https://doi.org/10.1016/j.mset.2018.10.005>
- Onyelowe, K. C., D. Bui Van, M. Nguyen Van, C. Ezugwu, T. Amhadi, F. Sosa, Weiwu, Thinh Ta Duc, F. Orji, & G. Alaneme, (2019b). Experimental assessment of subgrade stiffness of lateritic soils treated with crushed waste plastics and ceramics for pavement foundation, *International Journal of Low-Carbon Technologies* 2019, 1–18. [doi:10.1093/ijlct/ctz015](https://doi.org/10.1093/ijlct/ctz015).
- Onyelowe, K. C., Alaneme, G., Bui Van, D., Nguyen Van, M., Ezugwu, C., Amhadi, T., Sosa, F., Orji, F., & Ugorji, B. (2019c). Generalized Review on EVD and Constraints Simplex Method of Materials Properties Optimization for Civil Engineering. *Civil Engineering Journal*, Vol. 5(3), pp. 729-749. <http://dx.doi.org/10.28991/cej-2019-03091283>
- Onyelowe, K. C. (2017). Mathematical Advances in Soil Bearing Capacity. *Electronic Journal of Geotechnical Engineering*, 2017 (22.12), pp 4735-4743. [www.ejge.com](http://www.ejge.com)

- Rutkowski, L. (2004). *Flexible neuro-fuzzy systems: structures, learning and performance evaluation*. Kluwer Academic Publishers; 2004
- Salahudeen, A. B., Ijimdiya, T. S., Eberemu, A. O., & Osinubi, K. J. (2018). Artificial neural networks prediction of compaction characteristics of black cotton soil stabilized with cement kiln dust. *J Soft Comput Civ Eng* 2(3):53–74.
- Salahudeen, A. B., Sadeeq, J. A., Badamasi, A., & Onyelowe, K. C. (2020). Prediction of Unconfined Compressive Strength of Treated Expansive Clay Using Back-Propagation Artificial Neural Networks 'Nigerian Journal of Engineering, Vol. 27, No. 1, April 2020. ISSN: 0794 – 4756. Pp. 45 – 58.
- Segad, B., Jönsson, M., Åkesson, T., & Cabane, B. (2010). Ca/Na Montmorillonite: Structure, Forces and Swelling Properties. *American Chemical Society, Langmuir*, vol. 26 (8), pp. 5782-5790. <https://doi.org/10.1021/la9036293>
- Segui, P., Aubert, J. E., Husson, B., & Measson, M. 2013. Utilization of a natural pozzolan as the main component of hydraulic road binder. *Construction and Building Materials*, 40: 217-223.
- Shahin, M. A., Jaksa, M. B., & Maier, H. R. (2001). Artificial neural network applications in geotechnical engineering. *Aust Geomech* 2001:49–62.
- Sobhani, J., Najimi, M., Pourkhorshidi, A. R., & Parhizkar, T. (2010). Prediction of the compressive strength of no-slump concrete: A comparative study of regression, neural network and ANFIS models. *Cons. Build. Mat.*, 24, 709–718.
- Wang, J., & Rahman, M. S. (2002). Fuzzy neural network models for liquefaction prediction. *Soil Dyn Earthquake Eng* 2002;22(8):685–94.



## APPLICATION OF INFORMATION AND COMMUNICATION TECHNOLOGY FOR THE IMPLEMENTATION OF HEALTH AND SAFETY MEASURES BY CONSTRUCTION FIRMS IN ABUJA, NIGERIA

Abdullateef Adewale Shittu<sup>1</sup>, Anita Dzikwi Adamu<sup>2</sup>, Abel John Tsado<sup>3</sup>, Lois Adedamola Arowolo<sup>4</sup> and Shakirat Remilekun Abdulazeez<sup>5</sup>

<sup>1,2,3,4</sup>Department of Quantity Surveying, Federal University of Technology, Minna, Nigeria

<sup>5</sup>Department of Estate Management, Waziri Umaru Federal Polytechnic, Birnin Kebbi, Nigeria

The Nigerian construction industry contributes 12% of Gross Domestic Product (GDP) to the nation's economy. In spite of this, studies have shown that health and safety (H&S) measures are poorly implemented by construction firms in Nigeria. Therefore, this study assessed the application of Information and Communication Technology (ICT) on the implementation of H&S measures by construction firms in Abuja, Nigeria. The study employed the use of quantitative research approach with the aid of questionnaire survey to obtain data from 25 construction firms in Abuja that are registered with Federation of Construction Industry (FOCI). Analysis of data was undertaken using Mean Item Score (MIS) and Relative Index (RII). Findings from the study show that H&S measures mostly requiring the use of ICT tools for proper implementation on construction sites which are Creating safety and health regulation and hazard identification, prevention and control (RII = 0.99). Site surveillance technologies (CCTV) is the ICT tools mostly required for monitoring the level of compliance to H&S measures on construction sites (RII = 0.98). The impact of ICT tools on the level of compliance to H&S measures on construction sites is significant (MIS = 4.46). Contractors' compliance with safety regulation is the most effective strategy for enhancing the safety performance of construction firms on construction sites with the use of ICT tools (MIS = 4.44). It was concluded that use of ICT tools has significant impact on the level of implementation of H&S measures by construction firms. It was recommended that construction firms should set up workable mechanism for effectively implementing the strategies required to enhance the H&S performance of construction firms through the use of ICT tools.

Keywords: construction firms, health and safety measures, information and communication technology

<sup>1</sup> latishittu74@gmail.com; funsho@futminna.edu.ng

<sup>2</sup> ninadzi@futminna.edu.ng

<sup>3</sup> tsado@futminna.edu.ng

<sup>4</sup> greatoyin@gmail.com

<sup>5</sup> shakiratabdulazeez25@gmail.com

## INTRODUCTION

The construction industry has recently witnessed a paradigm shift from traditional paper-based method of service delivery to electronic information exchange using Information and Communication Technology (ICT), at least in the western world like UK and even in developing countries like Nigeria (Ibironke et al., 2011). It is therefore evident that the adoption of ICT can enhance construction productivity and improve communications for effective decision-making and coordination among construction participants and reduce H&S risks on construction sites if it can be applied. Interestingly, ICT has been embraced in every sector of the economy including some aspects of the construction sector in ensuring that various tasks are carried out more efficiently and effectively. Unfortunately, in the domain of H&S, the use of ICT has not been adequately explored especially in the areas of H&S site inspection and supervision in order to ensure strict compliance (Ahmad, 2019).

Studies in H&S have only been able to discover low level implementation and compliance to H&S measures on construction sites and suggested strategies for improvement (Shittu et al., 2016; Shittu et al., 2017; Eze et al., 2018; Ahmad, 2019). These strategies have not been able to effectively reverse the trend significantly. The use of ICT to facilitate the level of compliance to the H&S measures has therefore not been addressed. In view of the fact that ICT is comprised of tools that use Artificial Intelligence (AI) to carry out tasks more safely, efficiently and effectively, it is a better option worthy of being adopted for enhancing the level of compliance to H&S on sites. This is due to the fact that the use of ICT tools is better for the monitoring and evaluation of implementation of H&S measures on construction sites as compared with the conventional approach which had been suggested by previous studies and have failed to yield the desired outcome. On account of this, Pamulu & Bhuta (2004) reported that technological advancement can no longer be viewed as an enhancement of traditional business procedures but rather as an innovation agent that enables new and different alternatives to operation of business organisation. It is on this premise that this study assessed the application of ICT for implementation of H&S measures by construction firms in Abuja. Therefore, in the context of this work application of ICT means the use of ICT for the implementation of H&S measures on sites.

In view of this background, this study addressed the problem of lack of proper implementation of H&S measures on construction sites which leads to increase in the rates of accidents, injuries and fatalities on sites. The resultant effect is poor H&S performance of construction firms in terms of cost due to compensation to injured workers. It is therefore imperative to assess the application of ICT on the implementation of H&S measures by construction firms in Nigeria using Abuja as the study area. Abuja was chosen as the study area because a reasonable number of construction activities take place in Abuja because it experiences rapid population increase and new developmental projects daily as a result of rapid urbanisation and rural-urban migration since it is the capital city of Nigeria (Kadiri et al., 2014).

In order to proffer suggestions towards addressing the research problem identified, the study aimed at assessing the application of ICT for implementation

of H&S measures by construction firms in Abuja with a view to enhancing the safety performance of construction firms. The following objectives were therefore pursued in order to achieve the aim of the study:

1. To identify and examine the H&S measures mostly requiring the use of ICT tools for proper implementation on construction sites.
2. To identify the ICT tools mostly required for monitoring the level of compliance to H&S measures on construction sites in Abuja.
3. To determine the impact of the identified ICT tools on the level of compliance to H&S measures on construction sites.
4. To propose strategies for enhancing the safety performance of construction firms through the use of ICT tools for monitoring and evaluation of compliance to H&S measures on construction sites.

## REVIEW OF RELATED LITERATURE

### **H&S measures requiring the use of ICT tools for proper implementation on construction sites**

Construction H&S measures are best site practices that should be implemented towards ensuring the health, safety and welfare of individuals involved in work employment. Idoro (2011) revealed that all categories of contractors working in the Nigerian construction industry do not perform better than one another as regards H&S and therefore calls on stakeholders within the industry to develop and enhance their H&S performance. Hence, the use of ICT can increase the level of implementation of H&S measures by workers on construction sites, thereby improving the safety performance of construction firms in the Nigerian construction industry.

In order to achieve these past studies have identified the H&S measures requiring the use of ICT tools to include: Creating safety and health regulation; Identify hazard; Worker safety training; Design for safety; Safety planning (job hazard analysis and planning); Accident investigation; and Facility and maintenance phase safety; Assess and evaluation risk; Decide precautions; Record findings; and Review and update (Rajendran & Clarke, 2011; Charehzehi & Ahankoob, 2012; OSHA, 2016; Lekan & Charles, 2017; Webb & Langar, 2019)

### **ICT tools required for monitoring level of compliance to H&S measures on construction sites**

AHT Group (2014), Bromley et al. (2014) and Zhang et al. (2017) reported that Remote Sensing (RS), in combination with modern Information and Communication Technology (ICT) can be used to effectively monitor the level of compliance of workers on site at a low cost and with time saving in construction. These RS tools are identified as: Unmanned Aerial Vehicles (UAV); GPS navigation system; Mobile telecommunications interception equipment; Intrusion software; IP Network Surveillance; Monitoring; Lawful Interception (LI) systems; Data retention systems; Digital forensics; Probes; Deep Packet Inspection (DPI); Radio frequency identification (RFID), WLAN, UWB, Zigbee; Ultrasound Modelling and visualization (3D-CAD, 4D-CAD); Electronic document management system (EDMS); Site

surveillance technologies (CCTV); Video conferencing; Project specific websites (Extranets); Electronic tendering; Electronic purchasing; Tele conferencing; and barcodes. The contributions of According to Mohan & Varghese (2019) revealed that with the help of Artificial Intelligence (AI), safety in construction sites can be monitored at ease. An example of this is the AI Enabled Building Information Modelling (BIM).

### **Impact of ICT Tools on the level of compliance to H&S measures on construction sites**

According to Idoro (2011), best site practices on H&S protect co-workers, employers, customers, suppliers and members of the public influence by the workplace environment. In addition to this, Ikechukwu et al. (2011) reported that different government and private boards within have made regulations and code of conduct in consideration of the importance and need for efficiency and the effective use of ICT. The evolution of technology which has led to the invention and development of telephones, computers, electronic and electrical equipment are all fundamental in the present day construction industry. The value is very important as construction projects involve a large flow of construction documentary information linking project participants during both design and construction phases.

According to Eastman et al. (2011), Cheng & Teizer (2013), Tahir et al. (2015), Azmy & Zain (2016), Park et al. (2017), Zhang et al. (2017), Uchenna et al. (2018) and Webb & Langar (2019) in an effort to improve construction processes, the application of innovative wireless communication technology such as the RFID technology can be employed to minimise accident and improve H&S on construction sites. In a similar view, Alomari et al. (2017) reported that an added benefit of BIM as an ICT tool is ease of communication and collaboration among stakeholders.

### **Strategies for enhancing safety performance of construction firms through the use of ICT tools**

The major strategies for enhancing the safety performance of construction firms, as identified by past studies (Sawacha et al., 1999; Teo et al., 2005), are that project managers should focus more attention to provision of sufficient company policies, safe procedures, positive attitudes of construction personnel, high efficiency in management commitment and adequate safety knowledge and training of staff. In addition, one of the main elements for improving safety performance in construction projects identified by Charehzehi & Ahankoob (2012) and Tahir et al. (2015) are: Risk Analysis in the Design Stage; Training Strategy; Reward Policy; Management Commitment to the Implementation of Safety Culture; Contractor Comply with Safety Regulation; Providing Safe Equipment and Tools; Personnel Selection; Take a Responsibility to Report Near-Miss Accident; and Creating safety and health regulation.

## **CONCEPTUAL FRAMEWORK FOR THE STUDY**

Studies on H&S management have designed various implementable framework for improving safety performance of workers and employers in construction projects. Some of the ones applicable to this study are: H&S performance measurement



model (Health and Safety Executive, HSE, 2001); Construction competency and H&S performance framework (Dingatag et al., 2006); and Construction safety implementation framework (Ahmed & Abid, 2013). It is based on these theoretical frameworks that this study's conceptual framework was developed as presented in Figure 1.

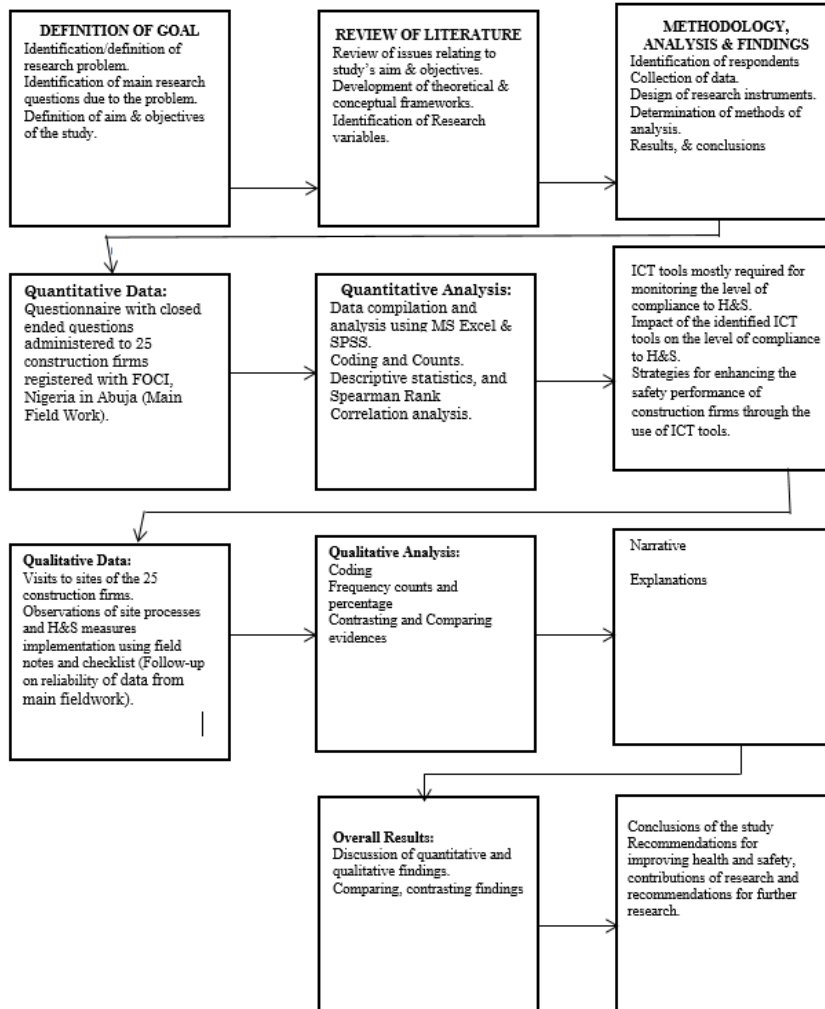

Figure 1: Conceptual framework for the study

## RESEARCH METHODOLOGY

The quantitative research approach was adopted in this study. The use of structured questionnaire was employed for data collection in order to achieve the study's objectives. The data collected were analyzed with the use of Relative Importance Index (RII) and Mean Item Score (MIS). MIS and RII were employed because it is the perception of safety officers that was sought with the questionnaire.

The population for the study is made up of construction firms registered with Federation of Construction Industry (FOCI) with Abuja's business address. FOCI was incorporated in 1954 and it is a mixture of indigenous, indigenized and foreign enterprises (FOCI, 2012). It is the umbrella of construction companies in Nigeria. Its membership is comprised of both construction active (full time) and non-

construction active (part time) members. FOCI has more than 100 members. Only about 84 of these are full time members which are construction firms across Nigeria. Of this 84, only 25 are active or domicile in Abuja (FOCI Directory, 2019). Since the study area is Abuja, then the 25 construction firms registered with FOCI and based in Abuja were considered for the study. The research population size is therefore 25.

The list containing information about the construction firms registered with FOCI in Abuja constitutes the study's sampling frame. This gives the features of the construction firms for easy access to aid the data collection process for the study. The sample size for the study is the same as the population size (that is 25). Therefore, all the 25 construction firms registered by FOCI in Abuja were considered for data collection. In view of the fact that the population size is not large, the study took a census of the whole 25 construction firms for data collection. This is in line with the assertion of Watson (2001) that if the population size is small (200 or less), then it is preferable to take a census of the total population.

The questionnaire (designed on a five-point Likert's Scale format) is comprised of five sections. The first section addressed issues relating to the profile of respondents. The last four sections addressed issues relating to the research objectives respectively. For the site observation, the use of a checklist form was employed to record what was about the firms 'provision of pro-active and reactive H&S measures on site as detailed out in the results section. The site observation took an average of 5 days for each construction firm. Twenty – five copies of questionnaire were administered (one copy to the safety officer of each firm). All the questionnaire copies distributed were returned and useful for analysis.

In order to validate the research instrument used, a reliability test was carried out on the data collected. The result of the reliability test shows a Cronbach's Alpha of 0.848 which was very high and close to 1.000. The Cronbach's Alpha based on standardized items is 0.849 and is of a higher value and closer to 1.000. This shows that the research data are reliable and hence the research instrument is valid. The decision rule adopted for the RII and MIS are summarised in Table 1.

**Table 1: Decision rule for RII and MIS analyses**

Scale	Cut-Off Point		Interpretation		
	<i>RII</i>	<i>MIS</i>	<i>Level of Importance</i>	<i>Level of Significance</i>	<i>Level of Effectiveness</i>
5	0.81 - 1.00	4.51 - 5.00	Very Important	Very Significant	Very Effective
4	0.61 - 0.80	3.51 - 4.50	Important	Significant	Effective
3	0.41 - 0.60	2.51 - 3.50	Fairly Important	Fairly Significant	Fairly Effective
2	0.21 - 0.40	1.51 - 2.50	Less Important	Less Significant	Less Effective
1	0.00 - 0.20	1.00 - 1.50	Least Important	Least Significant	Least Effective

Source: Adapted and Modified from Shittu et al. (2015b)

The study chose 3.51 – 5.00 as the cut-off point for the important H&S measures due to the fact that H&S, being a crucial issue to the well-being of workers and

success of a project, requires best practices in order to bring about improved performance. Based on the scale used (1 - 5), best H&S measures should be far above average. In addition, in the study of Agumba & Haupt (2014) the mean score of the identified important H&S practices ranged between 3.80 and 4.60. Within the same context, the studies of Eze et al. (2016), Shittu et al. (2017) and Shittu et al. (2020) also used a cut-off point of 3.50 – 5.00 for the important H&S measures on construction site. This therefore justifies the choice of 3.50 – 5.00, used in this study as the cut-off point for the important H&S measures requiring the use of ICT tools for proper implementation, significant impacts of ICT tools on H&S measures implementation, and effective strategies for improving the implementation level of H&S measures on construction sites.

## RESULTS AND DISCUSSION

### Results and discussion on H&S measures mostly requiring the use of ICT tools for proper implementation on construction sites

Table 2 presents the result of the H&S measures mostly requiring the use of ICT tools for proper implementation on construction sites.

**Table 2: Results of H&S measures mostly requiring the use of ICT tools for proper implementation on construction sites in Abuja**

Code	H&S Measures	RII	Rank	Decision
C1	Creating safety and health regulation	0.99	1st	Very Important
C2	Hazard Identification	0.98	2nd	Very Important
C3	Hazard prevention and control	0.98	2nd	Very Important
C4	Facility and maintenance phase safety	0.97	4th	Very Important
C5	Risk Assessment and Evaluation	0.96	5th	Very Important
C6	Education and training	0.96	5th	Very Important
C7	Precautions Decision Making	0.94	7th	Very Important
C8	Management leadership	0.94	7th	Very Important
C9	Communication and coordination for employers on multiemployer worksites	0.94	7th	Very Important
C10	Design for safety	0.94	7th	Very Important
C11	Record findings	0.92	11th	Very Important
C12	Review and Update	0.92	11th	Very Important
C13	Accident investigation, Facility and maintenance phase safety	0.90	13th	Very Important
C14	Worker participation	0.86	14th	Very Important
C15	Program evaluation and improvement	0.85	15th	Very Important
<i>Average RII</i>		<i>0.94</i>		<i>Very Important</i>

Table 2 reveals fifteen (15) identified H&S measures mostly requiring the use of ICT tools for proper implementation on construction sites which are all very important with MIS ranging from 0.85 – 0.99. The most important H&S measure is Creating safety and health regulation (MIS = 0.99), while the least important one is Program evaluation and improvement (MIS = 0.88). The average MIS value shown is 0.94. This also reveals that all the identified H&S measures mostly requiring the use of ICT tools for proper implementation on construction sites are very important. This is in line with the finding of Charehzehi & Ahankoob (2012) where it was revealed that these H&S measures are guidelines to assist the team members in the construction industry to manage their safety in their workplaces with the use of ICT tools. OSHA (2016) also identified these measures as good H&S practices where the use of ICT tools are required in support of the finding of this study. Rajendran & Clarke (2011) also identified most of these H&S measures as vital areas in which BIM can prove useful. Other previous studies which support the finding of this study are Lekan & Charles (2017); Amusan et al. (2018); and Webb & Langar (2019). All these studies emphasize the need to for stakeholders within the construction industry to develop and enhance their H&S performance (with respect to these H&S measures) through the use of ICT tools. Hence, the use of ICT can increase the level of implementation of H&S measures by workers on construction sites, thereby improving the safety performance of construction firms in the Nigerian construction industry.

### **Results and discussion on ICT tools mostly required for monitoring the level of compliance to H&S measures on construction sites in Abuja**

The use of Relative Importance Index (RII) was employed to examine the ICT tools mostly required for monitoring the level of compliance to H&S measures on construction sites in Abuja. The result of the analysis is presented in Table 3.

Table 3 shows the 18 ICT tools mostly required for monitoring the level of compliance to H&S measures on construction sites. It was shown that Site surveillance technologies (CCTV), Remote Sensing (RS) standard cellular phones, smart phones or tablets, Mobile Radio Systems, Electronic document management system (EDMS), and Email and short message services (SMS) are the most important ICT tools with RII values of 0.98, 0.96, 0.94, 0.92 and 0.90 respectively. Five (%) other ICT tools are also very important. These are Radio Frequency Identification Device (RFID), GPS (Global Positioning System), Modelling and visualization (3D-CAD, 4D-CAD), Ultra-wideband (UWB), and 3D and 4D visualization technology with RII values of 0.89, 0.86, 0.85, 0.84 and 0.83 respectively. The remaining eight (8) ICT tools (in descending order) are also important with RII values ranging from 0.80 – 0.62. On the average, all the identified ICT tools are required for monitoring the level of compliance to H&S measures on construction sites in Abuja are very important with average RII value of 0.83. The finding here agrees with the finding from the study of AHT Group (2014) which reported that RS, in combination with modern ICT, provides an excellent means for the collection and analysis of spatial data on “real world phenomena”, making these tools particularly valuable for project planning and monitoring in the development cooperation context. The finding of this study is also supported by that of Tahir et al. (2015) where it was stated that that wireless sensing technology, such as the RFID, can be used to examine H&S of individuals and equipment on site. This is because RFID tags transmit wireless data to a system with RFID reader which in turn develops a

warning system that alerts construction workers of potential threats. Other studies such as Bromley et al. (2014); Azmy & Zain (2016); Zhang et al. (2017); and Mohan & Varghese (2019) also confirms the importance of these ICT tools to H&S compliance. It is therefore important to emphasize that for a safe and healthy construction workplace, the use of ICT tools for monitoring compliance to H&S rules is important.

**Table 3: Results of ICT tools mostly required for monitoring the level of compliance to H&S measures on construction sites in Abuja**

Code	ICT Tools	RII	Rank	Decision
B1	Site surveillance technologies (CCTV)	0.98	1st	Very Important
B2	Remote Sensing (RS) standard cellular phones, smart phones or tablets.	0.96	2nd	Very Important
B3	Mobile Radio Systems	0.94	3rd	Very Important
B4	Electronic document management system (EDMS)	0.92	4th	Very Important
B5	Email and short message services (SMS)	0.90	5th	Very Important
B6	Radio Frequency Identification Device (RFID)	0.89	6th	Very Important
B7	GPS (Global Positioning System)	0.86	7th	Very Important
B8	Modelling and visualization (3D-CAD, 4D-CAD)	0.85	8th	Very Important
B9	Ultra-wideband (UWB)	0.84	9th	Very Important
B10	3D and 4D visualization technology	0.83	10th	Very Important
B11	Video conferencing	0.80	11th	Important
B12	IP Network Surveillance	0.78	12th	Important
B13	Wireless local area network (WLAN)	0.78	12th	Important
B14	Zigbee (two-way wireless communication technique)	0.78	12th	Important
B15	Ultrasound positioning system	0.77	15th	Important
B16	Artificial Intelligence Enabled BIM	0.72	16th	Important
B17	Unmanned Aerial Vehicles (UAV)	0.70	17th	Important
B18	Real-Time tracking system, RFIDs, automation and remote sensing technology	0.62	18th	Important
<i>Average RII</i>		<i>0.83</i>		<i>Very Important</i>

### Results and discussion on impact of ICT tools on the level of compliance to H&S measures on construction sites

Table 4 gives a summary of the MIS ranking results of the impact of ICT tools on the level of compliance to H&S measures on construction sites in Abuja based on respondents' perception.

**Table 4: Results of impact of ICT tools on the level of compliance to H&S measures on construction sites in Abuja**

Code	Impact of ICT Tools on the Level of Compliance to H&S Measures	MIS	Rank	Decision
D1	Providing a high level of safety training for employees.	4.80	1st	Very Significant
D2	Avoid the direct and indirect costs of worker injuries and illnesses, and promotes a positive work environment.	4.80	1st	Very Significant
D3	Enable management to avoid accidents and eliminate H&S hazards so as to reduce the difficulty of employees as well as minimising their loss.	4.76	3rd	Very Significant
D4	Reduce lots of fatalities and improve productivity by providing solutions and remedy to H&S problems and also providing workers on site with potential occurrence of existing danger on construction site.	4.76	3rd	Very Significant
D5	Aid operational improvement through communication of construction information for effective decision-making and coordination.	4.72	5th	Very Significant
D6	BIM tools allow project stakeholders to share information about sequencing, physical site topography, and clash detection; improve communication among the project stakeholders; and identify potential locations and times of hazardous and non-hazardous construction project activities.	4.68	6th	Very Significant
D7	The virtual planning of work sequencing to incorporate necessary safety equipment and measures.	4.68	6th	Very Significant
D8	Create a detailed Environmental Safety and Health (ES and H) plan to be dispersed among all workers.	4.68	6th	Very Significant
D9	Providing new methods in construction and planning such as Building Information Modeling methodology and IBS technology.	4.64	9th	Very Significant
D10	Increase the level of implementation of H&S measures by workers on construction sites.	4.60	10th	Very Significant
D11	Verification that all structures can be constructed safely and productively.	4.60	10th	Very Significant
D12	Integration of client, designer and contractor in design stage to eliminate adversarial nature and preventing conflict in early stage of projects which lead to mitigate the destructive risk during building process.	4.56	12th	Very Significant
D13	Offer opportunities to enhance communication between participants in construction projects and to enable more effective and efficient communication.	4.52	13th	Very Significant
D14	Decrease time for data processing and communicating information.	4.52	13th	Very Significant
D15	Improvement of site condition	4.52	13th	Very Significant
D16	Avoiding the use of outdated equipment and plants during construction stages.	4.52	13th	Very Significant
D17	Harnessing the capability to improve safety training as workers can "walk through" a job site or building increases understanding and helps prepare for the sequencing of tasks.	4.52	13th	Very Significant
D18	Obtain timely information regarding work progress to manage workflows.	4.32	18th	Significant
D19	Reduce the need for co-workers to be located in the same venue.	4.16	19th	Significant
D20	Protect co-workers, employers, customers, suppliers and members of the public influence by the workplace environment.	4.12	20th	Significant
D21	Intelligence of sensor-based technology helps construct an interactive management platform, which is the integration of hardware and software for data processing, significantly improving the construction site monitoring capacity and providing guarantees for construction safety.	3.88	21st	Significant
D22	Capacity building in Remote Sensing (RS) and ICT is key to attain sustainability by ensuring an adequate and professional use of these techniques in the post-project period.	3.68	22nd	Significant
D23	Have shaped substantially the mode of workers' interaction, business process, entertainment, learning and implementation attitude.	3.64	23rd	Significant
<i>Average MIS</i>		<i>4.46</i>		<i>Significant</i>

Table 4 revealed 23 main impacts of ICT tools on the level of compliance to H&S measures on construction sites. The first seventeen (17) impacts are very significant. These range from Providing a high level of safety training for employees (MIS = 4.80) to Harnessing the capability to improve safety training as workers can “walk through” a job site or building increases understanding and helps prepare for the sequencing of tasks (MIS = 4.52). The most significant impacts of ICT tools on the level of compliance to H&S measures on construction sites are Providing a high level of safety training for employees and Avoid the direct and indirect costs of worker injuries and illnesses, and promotes a positive work environment (MIS = 4.80 respectively). The remaining six impacts are also significant. These range from Obtain timely information regarding work progress to manage workflows (MIS = 4.32) to Have shaped substantially the mode of workers’ interaction, business process, entertainment, learning and implementation attitude (MIS = 3.64). On the average, all the identified impacts of ICT tools on the level of compliance to H&S measures on construction sites are significant (average MIS = 4.46). The finding of Ikechukwu et al. (2011) supports this study’s finding by emphasizing that the rapid evolution of ICT offers opportunities to enhance communication between participants in construction projects and to enable more effective and efficient communication. Webb & Langar (2019) also reported that the onus of safety management and site accident mitigation is shifting with the development of technology by incorporating BIM into project planning in support of this study. Therefore, the use of the intelligence of sensor-based technology helps construct an interactive management platform, which is the integration of hardware and software for data processing, significantly improving the construction site monitoring capacity and providing guarantees for construction safety.

### **Results and discussion on the strategies for enhancing the safety performance of construction firms on construction sites**

The result of the MIS analysis carried out to rank the perception of respondents on the identified strategies for enhancing the safety performance of construction firms is presented in Table 5.

It is shown from Table 5 that ten (10) out of the twelve (12) identified strategies for enhancing the safety performance of construction firms on construction sites in Abuja are effective. These range from Contractor Comply with Safety Regulation (MIS = 4/44) to Proper implementation of fatalities and incidence reporting/investigation with the application of innovative communication technology such as the RFID technology (MIS = 3.64). The two least ranked strategies are fairly effective. These are Development of Framework for Enhancing Strategies for Implementing Training and Re-training for Workers on Compliance to H&S (MIS = 3.44) and Introduction of Risk Analysis in the Design Stage (MIS = 3.20). On the average, all the identified strategies for enhancing the safety performance of construction firms on construction sites in Abuja are effective (average MIS = 3.96). The studies of Charehzehi & Ahankoob (2012) and Tahir et al. (2015) are in line with the finding from this analysis because these past studies emphasize that these strategies can improve H&S on site and thus minimising accidents occurrence such as accident due to heavy equipment’s and tools and also collision between workers and heavy operating equipment; which are considered as one of the most occurred on site. It is therefore important to note that for

construction firms to execute projects safely on construction sites, these effective strategies must be implemented to the latter.

**Table 5: Result of strategies for enhancing the safety performance of construction firms on construction sites in Abuja**

Code	Strategies for Enhancing the Safety Performance	MIS	Rank	Decision
E1	Contractor Comply with Safety Regulation	4.44	1st	Effective
E2	Site Personnel Selection	4.36	2nd	Effective
E3	Creating safety and health regulation.	4.32	3rd	Effective
E4	Hiring contractors who have proved a record of good safety performance during the processes of qualifying contractors for bidding work and ranking contractors for a contract award.	4.16	4th	Effective
E5	Providing Safe Equipment and Tools	4.16	4th	Effective
E6	Establishing a Reward Policy.	4.08	6th	Effective
E7	Management Commitment to the Implementation of Safety Culture	4.08	6th	Effective
E8	Establishment of effective company policies that will promote safe procedures, positive attitudes of construction personnel, high efficiency in management commitment and adequate safety knowledge and training of staff.	3.88	8th	Effective
E9	Take a Responsibility to Report Near-Miss Accident.	3.80	9th	Effective
E10	Proper implementation of fatalities and incidence reporting/investigation with the application of innovative communication technology such as the radio frequency identification (RFID) technology.	3.64	10th	Effective
E11	Development of Framework for Enhancing Strategies for Implementing Training and Re-training for Workers on Compliance to H&S	3.44	11th	Fairly Effective
E12	Introduction of Risk Analysis in the Design Stage	3.20	12th	Fairly Effective
<b>Average MIS</b>		<b>3.96</b>		<b>Effective</b>

## CONCLUSION AND RECOMMENDATIONS

The study revealed that the identified ICT tools required for monitoring the level of compliance to H&S measures on construction sites in Abuja are very important. The identified H&S measures mostly requiring the use of ICT tools for proper implementation on construction sites are very important. The most significant impacts of ICT tools on the level of compliance to H&S measures on construction sites are: providing a high level of safety training for employees; and avoiding the direct and indirect costs of worker injuries and illnesses, and promotes a positive work environment. In addition, all the identified impacts of ICT tools on the level of compliance to H&S measures on construction sites are significant. The identified



strategies for enhancing the safety performance of construction firms on construction sites in Abuja are effective. It can therefore be concluded that the application of ICT tools has a significant impact on the level of implementation of H&S measures by construction firms in Abuja. There is therefore the need for construction firms to embrace the use of ICT tools to monitor the implementation of H&S measures on site in order to improve the level of compliance to H&S measures and hence improve the safety performance/practices of employees and construction firms.

In view of the findings and conclusions of this study, the following recommendations were made:

1. The management of construction firms should invest in training their safety officers or anybody so assigned H&S responsibility on the use and application of Remotes Sensing tools in combination with modern ICT in order to be able to effectively plan and monitor site activities in a safety and health compliant manner. This will bring about improved H&S compliance of workers on site.
2. Regular and periodic education and training programmes should be used to communicate the importance of the identified H&S measures mostly requiring the use of ICT tools for proper implementation on construction sites to workers. This will build up positive attitude of employers and employees towards H&S practices on site and hence the improvement of H&S measures implementation level.
3. Construction firms should facilitate H&S communication by using the intelligence of sensor-based technology in order to construct an interactive management platform, which is the integration of hardware and software for data processing, significantly improving the construction site monitoring capacity and providing guarantees for construction safety. This is because the study has established that there exists a positive relationship between the use of ICT tools and level of implementing H&S measures on construction sites.
4. All the afore mentioned recommendations should be harmonised in order to put up a workable mechanism for the effective implementation of the identified strategies for enhancing the safety performance of construction firms on construction sites in Abuja. This is because the study found that these strategies are effective.

The findings of this study has contributed to the body of knowledge in the built environment in various ways. The study revealed that for a safe and healthy construction workplace, the use of ICT tools for monitoring compliance to H&S rules is important (average RII = 0.83). The study also showed that the use of ICT tools can increase the level of implementation of H&S measures by workers on construction sites (average RII = 0.94). It was also revealed that the impacts of ICT tools on the level of compliance to H&S measures on construction sites are significant (average MIS = 4.46).

In view of the limitations of this study, some areas have been suggested for further studies. Researchers can study the effect of safety officers 'leadership quality on the adoption of ICT tools and Artificial Intelligence for enhancing the level of

implementation of safety measures on construction sites. The effect of organisational characteristics on the on the application of ICT tools and Artificial Intelligence on the implementation of safety measures on construction sites can also be studied.

## REFERENCES

- Agumba, J. N., & Haupt, T. C. (2014). Implementation of Health and Safety Practices: Do Demographic Attributes Matter? *Journal of Engineering Design & Technology*. Emerald Group Publishing Limited. 12(4): 531 – 550. Available on [www.emeraldinsight.com/1726-0531.htm](http://www.emeraldinsight.com/1726-0531.htm)
- Ahmad, H. I. (2019). Effect of Site Sanitation on the Safety Performance of Workers on Construction Sites in Minna. An Unpublished B. Tech Thesis. Department of Quantity Surveying, School of Environmental Technology, Federal University of Technology, Minna – Nigeria.
- AHT Group (2014). Remote Sensing and ICT Tools in Project Planning & Monitoring. AHT Group AG, Management & Engineering. December. No. 50.
- Alomari, K., Gambatese, J., & Anderson, J. (2017). Opportunities for Using Building Information Modeling to Improve Worker Safety Performance. *Safety*, 3(7), 1-11.
- Amusan, L. M., Oloniju, L. I., Akomolafe, M., Makinde, A., Nkolika-Peter, P., Farayola, H., & Faith, O. (2018). Adopting Information and Communication Technology in Construction Industry. *International Journal of Mechanical Engineering and Technology (IJMET)*. January 2018, Volume 9(1): 739–746. ISSN Print: 0976-6340 and ISSN Online: 0976-6359. Available online at <http://www.iaeme.com/IJMET>.
- Anderson, J. (2007). "Health and safety- matching legislation and enforcement," *Proceedings of the Institute of Civil Engineers Management, Procurement and Law*, Cambridge Dictionaries Online. Cambridge University Press, pp.11-15.
- Awolusi, I. G. & Marks, E. D. (2017). Safety Activity Analysis Framework to Evaluate Safety Performance in Construction. *Journal of Construction Engineering Management*. ASCE. 143(3): 05016022-1 — 05016022-12.
- Azmy, N. & Zain, A. Z. M. (2016). The Application of Technology in Enhancing Safety and Health Aspects on Malaysian Construction Projects. *ARPN Journal of Engineering and Applied Sciences*. JUNE 2016. 11(11): 7209-7213. ISSN 1819-6608. Available on <http://www.arpnjournals.com/>
- Babaniyi, J. A., & Afolalu, O. F. (2010). Information and Communication Technology and the Nation at 50. A paper presented at the 5th Annual International Conference on Science Engineering and Environmental Technology, At the Federal Polytechnic, Ede, Osun State, Nigeria. 22nd & 25th November, 2010.
- Bromley, M., Steenhoek, K. J., Halink, S., & Wijkstra, E. (2014). ICT Surveillance Systems: Trade Policy and the Application of Human Security Concerns. *INTERNATIONAL ETSI TR*, UK. November 5, 2014. 2(2): 37-52. Available on [http://www.etsi.org/deliver/etsi\\_tr/101900\\_101999/101943/02.01.01\\_60/tr\\_101943v020101p.pdf](http://www.etsi.org/deliver/etsi_tr/101900_101999/101943/02.01.01_60/tr_101943v020101p.pdf)>.
- CBN (2007). Annual Report and Statement of Account for the year ended 31st December, 2006, Abuja: Central Bank of Nigeria.
- Charehzehi, A., & Ahankoob, A. (2012). Enhancement of Safety Performance at Construction Site. *International Journal of Advances in Engineering & Technology*, Nov. 2012. 5(1): 303-312. ISSN: 2231-1963.

- Cheng, T., & Teizer, J. (2013). Real-time resource location data collection and visualization technology for construction safety and activity monitoring applications. *Automation in Construction*, 34, 3-15.
- David, B. R., Idiako J. E., & Shittu, A. A. (2018). Effect of Health and Safety Management Practices on Safety Performance of Construction Contractors. In A. M. Junaid, O. F. Adedayo, R. A. Jimoh & L. O. Oyewobi (Eds.); *School of Environmental Technology International Conference (SETIC) 2018: Contemporary Issues and Sustainable Practices in the Built Environment*; 10 -12 April, 2018. School of Environmental Technology, Federal University of Technology, Minna, Nigeria. Vol. 1: 384 – 395.
- Dingatag, D. P., Biggs, H. C., Sheahan, V. L., & Cipolla, D. J. (2006). *A Construction Safety Competency Framework: Improving OH&S Performance by Creating and Maintaining a Safety Culture*. CRC Construction Innovation. Icon.Net Pty Ltd. Brisbane, Australia.
- Doko, A. U., Shittu, A. A., & Oke, A. A. (2018). Influence of Hazard Recognition Measures on Safety Performance of Building Workers in Abuja, Nigeria. *Proc: 6th National Economic, Management and Technology Conference: Development Issues & Challenges that Affects Infrastructure, Employment, Property Reduction & Food Security in Nigeria*. Abubakar Tafawa Balewa University, Bauchi, Bauchi State, Nigeria. 5th – 6th December, 2018. 107 – 115.
- Domdouzis, K., Kumar, B., & Anumba, C. (2007) *Radio-Frequency Identification (RFID) application: A brief introduction*, *Advance Engineering Information*.
- Eastman, C., Teicholz, P., Sacks, R., & Liston, K. (2011). *BIM Handbook: A Guide to Building Information Modeling for Owners, Managers, Designers, Engineers, and Contractors (2nd Ed.)*. Hoboken, NJ: John Wiley and Sons.
- Eze, C. J., Ayuba, P. & Shittu, A. A. (2018). Assessment of Accidents Hazard Impact in Nigerian Building Industry. *Centre for Human Settlement and Urban Development Journal (CHSUDJ)*. Centre for Human Settlement and Urban Development, Federal University of Technology, Minna; May, 2018. 7(1): 208 – 226. ISSN NO: 2141 – 7601.
- Famakin, I. O., Mekanjuola, S. A., Adeniyi, O. & Oladinrin, T. O. (2012). Impact of Construction Health & Safety Regulations on Project Parameters in Nigeria: Consultants and Contractors View. *FUTY Journal of the Environment*. School of Environmental Sciences, Modibbo Adama University of Technology, Yola – Nigeria. July 2012. 7(1): 114-122. ISSN: 1597-8826. Available on <http://dx.doi.org/10.4314/fje.v7i1.9>.
- FOCI (2012). *FOCI Sets to Hold its 2012 Exhibition*. Federation of Construction Industry, Nigeria. Available on [www.coolstuff49ja.com](http://www.coolstuff49ja.com)
- FOCI Directory (2019). *List of Construction Companies in Abuja*. Available on <https://foci.org.ng/full-members/>
- Gambo, M. D. (2017). Impact of Information Communication Technology on Building Construction Project Delivery in Nigeria. *International Journal of Sciences, Engineering & Environmental Technology (IJOSEET)*, 2(2): 10-16. ISSN 0794-9650. Available on [www.repcomset.com](http://www.repcomset.com)
- HSE (2001). *A Guide to Measuring Health and Safety Performance*. Health and Safety Executive (HSE) Priced Publication. HSE Books, Sudbury, Suffolk. [www.hse.gov.uk](http://www.hse.gov.uk).

- Ibironke, O. T., Ekundayo, D., & Awodele, O. A. (2011). A survey on the use and impact of information technology in quantity surveying service delivery in Nigeria In: Egbu, C. and Lou, E.C.W. (Eds.) Procs 27th Annual ARCOM Conference, 5-7 September 2011, Bristol, UK, Association of Researchers in Construction Management, 433-442.
- Idoro, G. I. (2011) 'Comparing Occupational Health and Safety (OHS) Management Efforts and Performance of the Nigerian Construction Contractors. 'Journal of Construction in Developing Countries.
- Idubor, E. E., & Osiamoje, M. D. (2013). "An exploration of health and safety management issues in Nigeria's effort to industrialize," *European Scientific Journal*, 9(12), pp.154-169.
- Ikechukwu, O., Nwachukwu, C., & Jamike, O. (2011). Information and communication technology in the construction industry. *American Journal of Scientific and Industrial Research*. 2(3): 461-468. ISSN: 2153-649X doi:10.5251/ajsir. Available on Huß, <http://www.scihub.org/AJSIR>
- Kadiri, Z. O., Nden, T. Avre, G. K., Oladipo, T. O., Edom, A., Samuel, P. O., & Ananso, G. N. (2014). Causes and Effects of Accidents on Construction Sites (A Case Study of Some Selected Construction Firms in Abuja F.C.T Nigeria). *IOSR Journal of Mechanical and Civil Engineering (IOSR-JMCE)*. 11(5): 66-72.
- Kasirossafar, M., & Shahbodaghlou, F. (2012). Application of visualization technologies to design for safety concept. *Forensic Engineering*, 370-377.
- Kheni, N. A. & Braimah, C. (2014). Institutional and Regulatory Frameworks for Health and Safety Administration: Study of the Construction Industry of Ghana. *International Refereed Journal of Engineering and Science (IRJES)*. 3(2): 24 – 34.
- Kheni, N. A. (2008). Impact of Health and Safety Management on Safety Performance of Small and Medium-Sized Construction Businesses in Ghana. An unpublished PhD Thesis, Loughborough University, UK.
- Kolo, D. N. (2015). Safety Issues Involving Workers on Building Construction Sites in Nigeria: An Abuja Study. Master's Thesis submitted to the institute of Graduate Studies and Research, Eastern Mediterranean University, North Cyprus.
- Lekan, M. A., & Charles, A. (2017). Multi-Parameter Optimization of Cost Entropy for Reinforced Concrete Office Building Projects Using Ant Colony Optimization. *Journal of Engineering and Applied Sciences*. 12(9): 2260-2275.
- Leslie, D. (2019). Understanding artificial intelligence ethics and safety: A guide for the responsible design and implementation of AI systems in the public sector. The Alan Turing Institute. <https://doi.org/10.5281/zenodo.3240529>
- Maqsood T., Walker, D. H. T., & Finegan, A. D. (2004). An investigation of ICT diffusion in an Australian construction contractor company using SSM, Proceedings. of the Joint CIB-W107 and CIB-TG23 Symposium on Globalisation and Construction, Bangkok, Thailand, 485-495.
- Mohan, M., & Varghese, S. (2019). Artificial Intelligence Enabled Safety for Construction Sites. *International Research Journal of Engineering and Technology (IRJET)*. June, 2019. 06(06): 681-685. e-ISSN: 2395-0056; p-ISSN: 2395-0072. Available on <http://www.irjet.net/>.
- Okeola, O. G. (2009). Occupational Health & Safety (OHS) Assessment in the Construction Industry. In: 1st Annual Civil Engineering Conference. University of Ilorin, Nigeria. 26-28th August. 236-246.

- Oladapo, A. A. (2007). An Investigation into the Use of ICT in the Nigerian Construction Industry. *ITcon*. March, 2007. Volume 12, 261-277. Available on <http://itcon.org/2007/18/>.
- Olanrewaju, S. B. O., & Okedare, D. K. O. (2018). Effect of the Use of ICT in the Nigerian Construction Industry. *The International Journal of Engineering and Science (IJES)*. 7(5) Ver. II: 71-76. ISSN (e): 2319 – 1813 ISSN (p): 23-19 – 1805.
- Oreoluwa, O. O., & Olasunkanmi, F. (2018). Health and Safety Management Practices in the Building Construction Industry in Akure, Nigeria. *American Journal of Engineering and Technology Management*. 3(1): 23-28. ISSN: 2575-1948 (Print); ISSN: 2575-1441 (Online). Available on <http://www.sciencepublishinggroup.com/j/ajetm>
- OSHA (2016). Recommended Practices for Safety & Health Programs in Construction. Occupational Safety and Health Administration. OSHA 3886. October 2016. Available on [www.osha.gov](http://www.osha.gov)
- Pamulu, M. S., & Bhuta, C. (2004). Managing Information Technology in Construction Industry: The Indonesian Experience. CIB World Building Congress. May 2 - 7. Westin Harbour Castle Hotel, Ontario, Canada. 1 – 8.
- Rajendran, S., & Clarke, B. (2011). Building Information Modeling: Safety Benefits and Opportunities. *Professional Safety*, 56 (10), 44-51.
- Sawacha, E., Naoum, S., & Fong, D. (1999). Factors affecting safety performance on construction sites. *International Journal of Project Management*. 17(5): 309-315.
- SGS Group (2009). Everything you construct is building your reputation. Retrieved May 17, 2010, from <http://www.sgs.com/sgs-ind-construction-building-your-reputationbrochure-en-09.pdf>
- Shittu, A. A., Ahmad, H. A., Isah, A. M., & Mohammed, N. M. (2020). Effect of Site Sanitation on the Safety Performance of Workers on Construction Sites in Minna, Nigeria. *Nigerian Journal of Technological Research (NJTR)*. Federal University of Technology, Minna, Nigeria. December Edition. Volume 16(1): xx – xx. Accepted on 10th November, 2020.
- Shittu, A. A., Ibrahim, A. D., Ibrahim, Y. M., & Adogbo, K. J. (2015a), Appraisal of health and safety management practices of construction SMEs in Abuja, Nigeria In: Laryea, S. and Leiringer R. (Eds) Procs 6th West Africa Built Environment Research (WABER) Conference, 10-12 August 2015, Accra, Ghana, 121-129.
- Shittu, A. A., Ibrahim, A. D., Ibrahim, Y. M., & Adogbo, K. J. (2015b). Assessment of Level of Implementation of Health and Safety Requirements in Construction Projects Executed by Small Firms in Abuja. In D. R. Ogunsemi, O. A. Awodele and A. E. Oke (Eds). Proceedings of the 2nd Nigerian Institute of Quantity Surveyors Research Conference. Federal University of Technology, Akure. 1st – 3rd September. 467 – 482.
- Shittu, A. A., Ibrahim, A. D., Ibrahim, Y. M., & Adogbo, K. J. (2015c). Impact of Demographic Features on Health and Safety Practices of Construction Contractors in Abuja, Nigeria. In A. Nasir, A. S. AbdulRahman and A. S. Kovo (Eds). Procs: 1st International Engineering Conference (IEC 2015). School of Engineering and Engineering Technology, Federal University of Technology, Minna, Nigeria. 1st – 3rd September. 31 – 46.
- Shittu, A. A., Ibrahim, A. D., Ibrahim, Y. M., Adogbo, K. J., & Mac-Barango, D. O. (2016). Impact of organisational characteristics on health and safety practices of construction contractors. *Nigerian Journal of Technological Research (NJTR)*. Federal University of Technology, Minna, Nigeria. 11(1): 60 – 67.

- Shittu, A. A., Idiako, J. E., Ibiyoju, S. E., Issa, A. A., & Shehu, M. A. (2017). Implementing Emergency Response Safety Procedures by Small-Sized Construction Firms in Abuja, Nigeria. In: Y. Ibrahim, N. Gambo & I. Katun (Eds). Proceedings of 3rd Research Conference (ReCon 3) of the Nigerian Institute of Quantity Surveyors, Bauchi. 25th – 27th September, 2017. 799 – 812.
- Shittu, A. A. (2016). Influence of Organisational Characteristics on Health and Safety Practices of Small and Medium-Sized Construction Companies in Abuja. An Unpublished PhD Thesis. Department of Quantity Surveying, Faculty of Environmental Design, Ahmadu Bello University, Zaria – Nigeria.
- Smallwood, J., & Haupt, T. (2005). The need for construction health and safety (H&S) and the construction regulations: Engineers' perceptions. *Journal of the South African Institution of Civil Engineering*. 47(2): 2-8.
- Smallwood, J. J., & Haupt, T. C. (2006). Impact of the construction regulations: the quantity surveyors' perceptions. In Sivyler, E. (ed.), Proceedings of the Annual Research of the Conference of the Royal Institute of Chartered Surveyors. University College, London. 7th and 8th December.
- Sulankivi, K., Zhang, S., Teizer, J., Eastman, C. M., Kiviniemi, M., Romo, I. & Granholm, L. (2013). Utilization of BIM-based Automated Safety Checking in Construction Planning. Proc. of 19th International CIB World Building Congress.
- Tahir, M. A., Namadi, A. S., Mohammed, Y., & Yahaya, I. M. (2015). Improving Health and Safety in the Nigerian Construction Sites Using Radio Frequency Identification (RFID). Proceedings of the Inter-Disciplinary Academic Conference on Uncommon Development. January, University of Jos Multi-purpose Hall, Main Campus, Jos, Plateau State. 15-16 2015. 4(3). Available on [www.hummingpub.com](http://www.hummingpub.com)
- Teo, E. A. I., Yean, F., Ling, Y. N. G., & Chong, A. F. (2005). Framework for project managers to manage construction safety. *International Journal of Project Management*. 23 (4): 329-341.
- Toole T. M. (2003). Information technology innovation: a view of large contractors, Proceedings of the ASCE Construction Research Congress, Honolulu, Hawaii, at <http://www.facstaff.bucknell.edu/ttoole/ITinnovation.doc>
- Uchenna, C. P., Chukwumeka, O., & Chukwuka, C. (2018). The Impact of ICT on National Security: A Case of Nigeria Security and Civil Defence Corps. *International and Public Affairs*, 2018; 2(3): 48-61. ISSN: 2640-4184 (Print); ISSN: 2640-4192 (Online). Available on <http://www.sciencepublishinggroup.com/j/ipa>.
- Watson, J. (2001). How to Determine Sample Size: Tip sheet #60, University Park, P.A: University Cooperative Extension, Pennsylvania State University.
- Webb, T. A., & Langar, S. (2019). Utilizing BIM as a Tool for Managing Construction Site Safety: A Review of Literature. 55th ASC Annual International Conference Proceedings. The Associated Schools of Construction. 330=347. Available on <http://www.ascpro.ascweb.org>.
- William, C. N. (2002) 'Risk Analysis Approach to Construction of Contractors Evaluation Method', *Journal of Construction, Engineering and Management*, ASCE, 128(4).
- Yisa, S. O. (2014). An investigation into the use of ICT in the Nigerian Construction Industry. Unpublished HND Project, Department of Building Technology, the Federal Polytechnic, Ado Ekiti.
- Zhang, M., Cao, T., & Zhao, X. (2017). Applying Sensor-Based Technology to Improve Construction Safety Management. *Sensors*. MDPI. , 17, 1841. Available on [www.mdpi.com/journal/sensors](http://www.mdpi.com/journal/sensors)



---

# ASSESSING THE CAUSES OF MATERIAL WASTAGE AS IT AFFECTS VARIOUS BUILDING MATERIALS ON NIGERIAN CONSTRUCTION SITES

A. A. Salihu, S. Gambo, M. M. Sa'ad, F. M. Oyeleke and J. Usman

<sup>1,2,3,4,5</sup>*Department of Building, Ahmadu Bello University, Zaria, Nigeria*

There is an increase in quantity of waste being generated by construction activities and this has caused major concern for the construction industry. An ineffective planning and control of materials on site could lead to poor performance and undesirable project outcomes which in turn affects the overall cost of a project. Previous researchers have tried to study the most wasteful material on building construction site and also established general causes of material wastage. However, no attempt has been made to bring a synergy between the causes of waste and the type of materials been wasted. Hence, this paper aimed at studying the causes of material wastage as it affects each building construction material used on site with a view to having an effective cost control. A quantitative approach involving the use of a structured questionnaire was used to collect data on a five (5) point Likert scale of 1- strongly disagree to 5- strongly agree. Responses from the administered questionnaire were collated, interpreted and analyzed using descriptive statistics and results presented in tables. Results indicated that poor handling of materials is the major factor resulting to materials wasted during timber formwork, concrete works and ceramic/vitrified tiling works with mean value of 4.46, 3.74 and 3.64 respectively. Furthermore, poor supervision of operatives is the major factor causing material wastage in POP works and mortar for rendering with mean value of 3.87 and 3.85 respectively. Poor handling of materials, poor supervision of operatives and misuse of materials are the major causes of waste on construction sites irrespective of the building materials involved. These factors could result to cost overrun and undesirable project outcomes. Therefore, proper material handling and high level of supervision should be given consideration when using timber, concrete, ceramic tiles, plaster of paris (POP) and mortar in construction sites. The study has affirmed the need for studies to focus on developing viable strategies/techniques that would bring about improvements in material handling when using timber, concrete and ceramic tiles in construction sites.

Keywords: building materials, construction sites, plaster of Paris (POP), project, wastage

## INTRODUCTION

Waste is defined as any unskillfulness resulting from lack of efficiency that results in the use of equipment's, materials, labour, or capital in larger quantities than those considered as necessary in the production of a building, in other words waste

is any losses produced by activities that generate direct or indirect costs but do not add any value to the product (Apte, 2012).

Odesola and Adewuyi (2015) view construction waste as construction Materials that are lost in transit on or off site, discarded without adding value to the project for which it was procured including over production or left over from newly constructed facility. A simple way to define waste according to Oladiran and Joseph (2009) is that which can be eliminated without reducing customer value, it can be activities resources or rule.

Rapid growth in construction activities as a result of increasing population and urbanization in many parts of the world generates a large amount of waste in construction. To minimize and effectively manage these wastes, a detailed understanding of the causal factors is required. (Luangcharoenrat et al., 2019).

Odesola and Adewuyi (2015) emphasized that the increasing quantities of waste have created a bad image for the construction industry, in addition, an ineffective planning and control of materials on sites could lead to poor performance and undesirable project outcomes.

According to Enshassi (2009) construction materials is the major cost of construction project; therefore, material wastage has adverse impact on construction cost, contractor's profit margin, construction duration and can be a possible source of dispute among parties to a project.

Materials constitutes a major cost component in any construction project, the entire cost of installed material may be 60% or more of the total cost of a project, so for a contractor to have more profit and to complete project on time there must be need to minimize waste to a minimal level. Waste on site can only be minimized but can never be eliminated completely (Aditya and Sabihuddin, 2015).

Ayodele and Alabi (2014) defined cost control as all methods of controlling the cost of building and civil engineering projects within the limits of a predetermined sum throughout the design and construction stages. Studies from different parts of the world has shown that material waste from the construction industry represents a relatively large percentage of the production cost.

Consequently, the poor management of materials and waste leads to an increase in the total cost of building projects (Ameh and Itodo, 2013).

Material wastage has become a serious problem and requires urgent attention in the Nigerian construction industry. The constraints negatively affects the delivery of many projects (Adewuyi and Otali, 2013). Ping, Omran and Pakir (2009) also observed that extra construction materials are usually purchased, due to the material wastage during the construction process.

(Chu, 2004; Formoso et al, 2002; Tam, Shen and Tam, 2007; Gihan, Ahmed and Adel, 2010) in their research have all tried to identify the percentage contribution of various construction material to waste on site. However in a more recent development Ameh and Itodo (2013) investigated building materials involved in waste and came up with the most wasteful ones where plastering/rendering topped the list.



In a separate development (Oladiran 2009; Otim, Nakacwa and Kyakula, 2011; Abdulazeez, 2000; Apte, 2012; Aditya and Sabihuddin, 2015) all tried to identify the causes of waste in construction sites.

However, based on literature search no research so far have tried to bring a synergy between the various types of building materials leading to waste and their causes. Hence the need to review the causes of material wastage as it affect various building materials on construction sites.

The objectives of this research are therefore to identify the causes of materials wastage on construction site and determine the effect of these causes on various building materials with a view to identifying the major causes of waste on varying building materials. For the purpose of this study, only building materials that had being previously identified by researchers as major waste contributors were considered. The impact of causes of waste on project cost was not considered in the study. The study could not consider construction professionals in all the states in Nigeria however, Abuja being the construction hub of the country was used.

## **LITERATURE REVIEW**

### **Material wastage on construction site**

According to Napier (2012), waste in construction occurs in various construction stages ranging from foundation works to finishing and they emanate from wooden materials, concrete, gravels, aggregate, masonry, metals, plastics, plumbing and electrical fixtures, glass and materials handling. A more recent study in the United State between (2009-2010) from the processing of 20,000 tons of construction and demolition waste identified the following percentage wastage of some building materials; wood 30%, concrete 5%, gravels, aggregate and fines, 20%, dry wall 3%, asphalt roofing 5%, ferrous and non-ferrous metals 9%, plastic 1%, cardboard and paper 3% and disposal as refuse 5%. Although the study concluded that the predominant waste stream in the United States comes from wood, wood however presents a high potential for reuse in construction and in other industry such as manufacturing. The US government in its effort to reduce the impact of building material waste on the environment has implemented the green rating criteria for all building project to further improve the environment performance (Amatruda, 2010).

According to Dania et al (2007), waste can never be eliminated but can be reduce to a minimum level, waste on construction site occurs whether directly or indirectly depending on the construction process. Waste occur at all stages of construction process right from design and documentation, excavation, renovation, refurbishment, ordering of materials, materials handling on site, up to the process of fixing. It has been observed that the construction industry remains a major economic sector, but the pollution generated from construction activities continuously present a major challenge to environmental management (Tam et al, 2007).

Abdul-azeez (2000) said there is a considerable waste allowance which is usually included when pricing, some material waste may occur under ideal conditions of production, but on many sites the waste of materials is far in excess of negligible

waste. He further stated that waste do occur in many ways but can be categorized into direct and indirect types, the most common materials being wasted on site are cement, reinforcement, timber, aggregate, bricks and blocks etc.

Review of building materials where wastage are predominant

Chu (2004) in a study in Hong Kong identified the percentage contribution of various construction materials to waste on site. These include mortar from plastering/screening 15%, concrete 4%, block work 4%, and packaging 5%. Wastage in concrete also occur as a result of failure in formwork and means of transportation. Non adherence to mix design can also contribute to wastage in concrete (Formoso et al, 2002). Tam et al (2007) noted that the cause of wastage in timber formwork is due to natural deterioration and waste from cutting. The wastage level in timber formwork can be as high as 20% in foundation works. The wastage level of timber formwork in foundation could be due to the wet nature of most foundation works, which encourage the deterioration of timber, it is worthy of note that both dry and wet weather has effects on timber formwork. The study also identified the building materials with low level of wastage are made from steel. This could be due to their durability and ease of re-use over time. This point is from a study from Egypt by Gihan, Ahmed and Abdel (2010) which reveal that steel reinforcement has low percentage of wastage of about 5% compared to 20% for sand in their study.

A study by Ameh and Itodo (2013) sought to know the most wasteful material during building construction activities on sites. The results reveals that out of 14 most frequently used building materials investigated, mortar from plastering /rendering top the list of most wasteful material. This was followed by timber formworks which is 2nd, sandcrete blocks comes 3rd and then concrete is 4th on the list and ceramics /vitrified tiles in that order. The results also revealed building materials that have low wastage level during construction activities on sites. These are steel formwork, long span aluminium roofing sheet, iron bar, paint and fibre cement roofing sheet. The findings reported in this study tends to support the outcome of earlier studies that the most wasteful building material on construction sites is mortar from plastering/rendering (Formoso et al, 2002). The study also attributed the high wastage level in mortar from plastering/rendering to lack of modular coordination in the structural elements and deviation from the actual design. This implied that more mortar will be used on such elements such as beams and column that have deviated from the initial design. Excessive mortar could also be used in block work joints if the blocks are not uniform in their sizes.

Another study by Bekr (2014) reveals quantitative assessment of wastage to 10 selected building materials due to cutting, transit, theft and vandalism, and application. The results indicate that sand has the highest percentage of waste of about 21% followed by aggregate with wastage of about 20.7%, PVC water pipes have 19.6% and similar results for timber formworks. On the other hands, facing stones had the least percentage wastage of 15.14%.

### ***Causes of material waste on construction sites***

Waste occurrences on sites are diverse but the most common waste in construction projects are materials. The consequences of materials waste are enormous because

materials account for about 50% to 60% of construction cost and they are scarce resources (Oladiran, 2009).

According to Otim et al (2011) the causes of material wastages on sites were found to include; poor supervision of operatives, poor handling of materials, misuse of materials, poor storage and stacking of materials, delivery of excess materials on site, poor site organization, late delivery of materials, poor coordination of management and technical side, poor time management, bad weather conditions and use of unskilled operatives. Construction material waste could also arise from design, logistics, and physical construction processes (Fadiya et al., 2014).

Some other researchers also identified some causes of material wastage which formed part of the review, these were however brought together and tabulated as shown in Table 1.

**Table 1: A comprehensive summary of the causes of waste**

Causes of Waste	Authors
Poor supervision of operatives	Oladiran, 2009; Otim, Nakacwa and Kyakula, 2011.
Poor handling of materials	Abdul-Azeez, 2000; Apte, 2012; Otim, Nakacwa and Kyakula, 2011.
Misuse of materials	Oladiran, 2009; Otim, Nakacwa and Kyakula, 2011.
Poor storage and stacking of materials	Abdul-Azeez, 2000; Aditya and Sabihuddin, 2015; Otim, Nakacwa and Kyakula, 2011.
Delivery of excess materials on site	Apte, 2012; Otim, Nakacwa and Kyakula, 2011.
Poor site organization	Abdul-Azeez, 2000; Otim, Nakacwa and Kyakula, 2011.
Late delivery of materials	Apte, 2012; Otim, Nakacwa and Kyakula, 2011.
Poor coordination of management and technical side	Otim, Nakacwa and Kyakula, 2011.
Poor time management	Otim, Nakacwa and Kyakula, 2011.
Bad weather conditions	Otim, Nakacwa and Kyakula, 2011.

## METHODOLOGY

The study looks at causes of materials wastage at it affects various building materials. This requires eliciting knowledge from construction professionals who are directly involved in any construction project, in this case Architects, Builders, Quantity Surveyors and Engineers. Hence a quantitative research approach involving the use of a structured questionnaire was used to collect data on a five (5) point Likert scale of 1- strongly disagree to 5- strongly agree. Population size for the research is unknown as no data was available on the precise number of these construction professionals currently practicing in Abuja. This location was chosen as it is well known for its high rate of construction activities owing to the fact that it is the Federal Capital Territory of Nigeria. The sample size was therefore determined from a table developed by Louangrath (2014) that the minimum sample size for an unknown population at 95% confidence level with 5% allowable error is approximately 34. A total of 52 questionnaire was distributed amongst the construction professionals in Abuja using purposive sampling techniques. The sampling technique allowed the researcher to choose respondents from large construction firms who are perceived to have handled large construction projects and gotten requisite experience. A total of 39 respondents representing 75% of the

questionnaire distributed and exceeding the determined sample size were analyzed using descriptive statistics (mean) and results presented in tables.

## RESULTS

### Summary of background information of respondents

This section presents the personal details of the respondent to include; their profession, level of education and years of experience.

**Table 2: Respondents profile**

Items	Frequency (NO)	Percentage (%)
<b>Profession</b>		
Architects	8	20.5
Builders	9	23.1
Quantity Surveyors	14	35.9
Engineers	8	20.5
Total	39	100
<b>Level of Education</b>		
HND	16	41.0
Bachelor's Degree	12	30.8
Master's Degree	9	23.1
Doctorate's degree	2	5.1
Total	39	100
<b>Years of Experience</b>		
0-5 years	4	10.3
6-10 years	10	25.6
11-15 years	19	48.7
16-20 years	6	15.4
20 and above	0	0
Total	39	100

Table 2 indicates that all categories of respondents represented had at least 20% representation each with Quantity Surveyors having a higher representation of 35.9%. Architects and Engineers are having the least representation of 20.5% each. A cumulative of 71.8% of the respondents have at least a bachelor's degree. Table 4.2 also shows that 10.3% of the respondents had between 0-5 years of experience. A cumulative of 89.7% of the respondents have at least 6 years of experience working on construction projects and would therefore be able to make correct and valid judgment.

### Causes of material waste as it affects building materials

The causes of wastage for each building material were scored by respondents based on a five Point Likert Scale of 1-strongly disagree to 5-strongly agree. Mean values were determined and standard deviation also determined to rank the causes that had the same mean values as shown in Table 3, 4, 5 and 6.

From Table 3, poor handling of materials was consistently agreed as the major factor leading to wastage when using materials such as timber, concrete and

ceramic/vitrified tiles in construction sites with a mean values of 4.46, 3.71 and 3.64 respectively.

**Table 3: Causes of wastage on timber for formwork, concrete and ceramic/vitrified tiles.**

	Building materials							
	Timber for formworks			Concrete			Ceramic tiles	
Causes of material wastage	Mean score	Std. Dev.	Rank	Mean score	Std. Dev.	Rank	Mean score	Rank
Poor handling of material	4.46	0.625	1 <sup>st</sup>	3.74	1.117	1 <sup>st</sup>	3.64	1 <sup>st</sup>
Misuse of material	3.85	0.875	2 <sup>nd</sup>	3.56	1.142	4 <sup>th</sup>	3.62	2 <sup>nd</sup>
Poor supervision of operatives	3.62	1.042	3 <sup>rd</sup>	3.59	1.208	2 <sup>nd</sup>	3.56	3 <sup>rd</sup>
Poor storage and stacking of materials	3.62	1.091	4 <sup>th</sup>	2.95	1.395	8 <sup>th</sup>	3.13	8 <sup>th</sup>
Poor site organization	3.54	1.448	5 <sup>th</sup>	3.44	0.821	7 <sup>th</sup>	3.41	5 <sup>th</sup>
Bad weather condition	3.51	1.144	6 <sup>th</sup>	3.49	1.211	6 <sup>th</sup>	3.36	6 <sup>th</sup>
Poor time management	3.49	0.885	7 <sup>th</sup>	3.56	0.912	3 <sup>rd</sup>	3.26	7 <sup>th</sup>
Late delivery of materials	3.41	1.208	8 <sup>th</sup>	2.77	1.327	10 <sup>th</sup>	2.97	9 <sup>th</sup>
Poor coordination of management and technical side	3.38	0.847	9 <sup>th</sup>	3.49	0.885	5 <sup>th</sup>	3.46	4 <sup>th</sup>
Delivery of excess materials on site	2.95	1.450	10 <sup>th</sup>	2.92	1.494	9 <sup>th</sup>	2.77	10 <sup>th</sup>

Poor time management ranked 7<sup>th</sup> in both timber and ceramic tiles with mean values of 3.49 and 3.26 respectively, however it is agreed as a major cause of waste in concrete material as it ranked 3<sup>rd</sup> with a mean value of 3.56. This has affirmed the need for proper time management whenever concrete is in use especially owing to the effect of setting time in concrete. As seen in Table 3 also, poor storage and stacking of materials is a major cause of waste when timber materials are used on construction sites by ranking 4<sup>th</sup> with a mean value of 3.62. The same cannot be said for concrete and ceramic tiles as the both ranked 8<sup>th</sup> with mean values of 2.95 and 3.13 respectively.

From Table 4, poor supervision of operatives was agreed to be the major cause of wastage in mortar and POP material with mean value of 3.85 and 3.87 respectively. This was closely followed by poor handling of material and misuse of material in both mortar and POP. Poor coordination of management and technical side is a causal factor in POP than that of mortar by ranking 4<sup>th</sup> and 7<sup>th</sup> respectively. However, poor storage and stacking of material ranked 8<sup>th</sup> and 5<sup>th</sup> in POP and mortar respectively.

**Table 4: Causes of wastage on mortar from plastering/rendering and POP**

	Building materials				
	Mortar from plastering/rendering			Plaster of Paris (POP)	
Causes of material wastage	Mean score	Std. Dev.	Rank	Mean score	Rank
Poor supervision of operatives	3.85	1.268	1	3.87	1
Poor handling of material	3.77	0.931	2	3.72	3
Misuse of material	3.64	1.328	3	3.85	2
Bad weather condition	3.62	0.990	4	3.41	6
Poor storage and stacking of materials	3.62	1.350	5	3.18	8
Poor site organization	3.41	0.993	6	3.67	5
Poor coordination of management and technical side	3.41	1.117	7	3.69	4
Poor time management	3.38	1.091	8	3.28	7
Late delivery of materials	3.36	1.063	9	2.85	10
Delivery of excess materials on site	3.31	1.360	10	3.08	9

**Table 5: causes of wastage on sandcrete blocks and clay tiles.**

	Building materials				
	Sandcrete blocks			Clay tiles	
Causes of material wastage	Mean score	Std. Dev.	Rank	Mean score	Rank
Misuse of material	3.85	0.779	1	4.51	1
Poor supervision of operatives	3.72	0.999	2	3.79	2
Poor site organization	3.41	0.785	3	3.49	5
Bad weather condition	3.41	1.117	4	3.59	4
Poor handling of material	3.38	1.206	5	3.62	3
Poor storage and stacking of materials	3.36	1.347	6	3.21	8
Poor coordination of management and technical side	3.15	0.875	7	3.28	7
Poor time management	3.05	1.191	8	3.44	6
Delivery of excess materials on site	3.05	1.450	9	2.69	10
Late delivery of materials	2.97	1.267	10	2.92	9

Table 5 shows that, misuse of material is the major cause of waste in sandcrete block and clay tile usage with a mean value of 3.85 and 4.51 respectively. Delivery of excess material and late delivery of material on site both ranked 9th and 10th as

the least waste causal factors when using sandcrete blocks and clay tiles in construction sites.

**Table 6: Summary of causes of waste on various building materials.**

	Building materials																	
	Cement mortar from plastering or rendering			Timber for formwork			Sandcrete Blocks			Concrete			Ceramic tiles		Clay tiles		Plaster of Paris (POP)	
Causes of material wastage	MS	SD	R	MS	SD	R	MS	SD	R	MS	SD	R	MS	R	MS	R	MS	R
Poor handling of material	3.77	0.93	2	4.46	0.63	1	3.38	1.21	5	3.74	1.12	1	3.64	1	3.62	3	3.72	3
Misuse of material	3.64	1.33	3	3.85	0.88	2	3.85	0.78	1	3.56	1.14	4	3.62	2	4.51	1	3.85	2
Poor supervision of operatives	3.85	1.27	1	3.62	1.04	3	3.72	1.00	2	3.59	1.21	2	3.56	3	3.79	2	3.87	1
Poor storage and stacking of materials	3.62	1.35	5	3.62	1.09	4	3.36	1.35	6	2.95	1.40	8	3.13	8	3.21	8	3.18	8
Poor site organization	3.41	0.99	6	3.54	1.45	5	3.41	0.79	3	3.44	0.82	7	3.41	5	3.49	5	3.67	5
Bad weather condition	3.62	0.99	4	3.51	1.14	6	3.41	1.12	4	3.49	1.21	6	3.36	6	3.59	4	3.41	6
Poor time management	3.38	1.09	8	3.49	0.89	7	3.05	1.19	8	3.56	0.91	3	3.26	7	3.44	6	3.28	7
Poor coordination of management and technical side	3.41	1.12	7	3.38	0.85	9	3.15	0.88	7	3.49	0.89	5	3.46	4	3.28	7	3.69	4
Late delivery of materials	3.36	1.06	9	3.41	1.21	8	2.97	1.27	10	2.77	1.33	10	2.97	9	2.92	9	2.85	10
Delivery of excess materials on site	3.31	1.36	10	2.95	1.45	10	3.05	1.45	9	2.92	1.49	9	2.77	10	2.69	10	3.08	9

MS=Mean Score; SD=Standard deviation; R=Rank

The study reveals that poor handling of materials is the major factor that caused material wastage when using timber for formwork, concrete and ceramic/ vitrified tiles with mean value of 4.46, 3.74 and 3.64 respectively. Poor supervision of operatives tops the list on plaster of Paris (POP) and mortar from plastering/rendering having a mean values of 3.87 and 3.85 respectively. And then misused of materials causes more wastage on clay tiles and sandcrete blocks with mean values of 4.51 and 3.85 respectively. Late delivery of materials and delivery of excess materials on site were ranked least amongst all the causes of wastage assessed, irrespective of the building materials been used on site.

## CONCLUSIONS AND FURTHER STUDIES

The study concludes that the main causes of waste on construction sites irrespective of the building materials in use are poor handling of materials, poor supervision of operatives and misuse of materials. Also material handling should be prioritize to minimize wastages arising from the use of timber for formwork, concrete and ceramic/vitrified tiles in construction sites. Proper handling of

material and high level of supervision could significantly minimize the amount of waste generated when using building materials such as timber, concrete, ceramic tiles, POP and mortar thereby leading to an effective cost control in construction projects. The study has given credence to the need for studies to focus on developing viable strategies/techniques that would bring about improvements in material handling when using timber, concrete and ceramic tiles in construction sites. Researchers can now identify specific ways which proper supervision can be achieved during construction to minimize waste when mortar and POP are in use.

## REFERENCES

- Abdul-Azeez, A. D. (2000). 'Evaluating material application waste on building construction sites'. Nigeria: Department of Building Library, Ahmadu Bello University, Zaria.
- Adewuyi, T. O., & Oтали, M. (2013) 'Evaluation of causes of construction material waste: Case of River State, Nigeria', *Ethiopian Journal of Environmental Studies and Management*, 6(6), pp. 746-753.
- Aditya, A. P., & Sabihuddin, S. (2015) 'Study of Material Management Techniques on Construction Project', *International Journal of Informative & Futuristic Research*, 2(9), pp. 3479-3486.
- Amatruda, J. (2010) *Evaluating and Selecting Green Products*. Whole Building Design Guide Website, National Institute of Building Sciences [online]. Available at <http://www.wbdg.org/resources/greenproducts.php> (Assessed: 21st December, 2019)
- Ameh, J. O., & Itodo, E. D. (2013) 'Professionals views of material wastage on construction sites', *Organization, Technology and Management in Construction an International Journal*, 5(1), pp. 747-757.
- Apte, R. K. (2012) 'Waste minimization of construction materials on bridge site (cement and reinforcement steel) - a regression and correlation analysis', *International journal Engineering and Innovative Technology*, 2(1), pp. 6-14.
- Ayodele, E. O., & Alabi, M. O. (2014) 'Effects of Cost Control on Building Projects Delivery in Nigeria', *Journal of Civil and Environmental Research*, 6(2), pp. 76-79.
- Bekr, G. A. (2014) 'Study of the Causes and Magnitude of Wastage of Materials on Construction Sites in Jordan', *Journal of Construction Engineering*, vol. 2014, Article ID 283298, 6 pages, <https://doi.org/10.1155/2014/283298>
- Chu, E. (2004) 'Waste Minimization', *Building and environment*, 39 (7), pp. 851-861.
- Dania, A. A., Kehinde J. O., & Bala, K. (2007) 'A Study of Construction Material Waste Management Practices by Construction Firms in Nigeria' *Proceedings of the 3rd Scottish Conference for Postgraduate Researchers of the Built and Natural Environment*, Glasgow, pp. 121-129.
- Enshassi, A. M. (2009) 'Factors Affecting the Performance of Construction Projects in the Gaza Strip', *Journal of Civil Engineering and Management*, 15(3), pp. 269-280.
- Fadiya, O. O., Georgakis, P., & Chinyio, E. (2014) 'Quantitative analysis of the sources of construction waste', *Journal of Construction Engineering*, 2014, pp.1-9.
- Formoso, C. T., Soibelman, L., De Cesare, C., & Isatto, E. L. (2002) 'Material waste in building industry: main causes and prevention', *Journal of Construction Engineering and Management*, 128(4), pp. 316-325.



- Gihan, L. G., Ahmed, R. A., & Adel, E. (2010) Material waste in the Egyptian construction industry. PhD thesis at the Faculty of Engineering, Cairo University, Egypt.
- Louangrath, P. T. I. (2014) Sample Size Determination for Non-Finite Population. International Conference on Discrete Mathematics and Applied Sciences (ICDMAS 2014). University of Thai Chamber of Commerce Conference Proceedings. Applied Science Section, Article No. 2.
- Luangcharoenrat, C., Intrachooto<sup>1</sup>, S., Peansupap, V., & Sutthinarakorn, W. (2019) Factors influencing construction waste generation in building construction: Thailand's perspective', *Journal of sustainability*, 2019(11), pp. 2-7
- Napier, T. (2012). 'Construction Waste Management', Whole Building Design Guide Website, National Institute of Building Sciences [online]. Available at <http://www.wbdg.org/resources/cwmgmt.php> (Assessed: 21st December, 2019).
- Odesola, A. I., & Adewuyi, T. O. (2015) 'Factors affecting material waste on construction sites in Nigeria', *Journal of Engineering and Technology*, 6(1), pp. 82-99.
- Oladiran, O. J. (2009) Causes and Minimization Techniques of Materials Waste in Nigeria Construction Process. Fifth international conference on construction in the 21st century (CITC-V) collaboration and integration in engineering management and technology, 20-22 May, Istanbul, Turkey.
- Otim, G., Nakacwa, F., & Kyakula, M. (2011) 'Cost Control Techniques Used On Building Construction Sites in Uganda', Second International Conference on Advances in Engineering and Technology, Faculty of Engineering, Kyambogo University, Kampala, Uganda. pp. 367-373.
- Ping, T. S., Omran, A., & Pakir, A. H. K. (2009). Material wastage in Malaysian construction industry. In: Proceedings of the International Conference on Economics and Administration (ICEA-FAA 2009), 14-15 November, Faculty of Business and Administration, University of Bucharest, Romania. pp. 257-264.
- Tam, V. W., Shen, L. Y., & Tam, C. M. (2007) 'Assessing the levels of material wastage affected by sub-contracting relationships and projects types with their correlations', *Building and Environment*, 42(3), pp. 1471-1477.





---

# ASSESSING THE LEVEL OF AWARENESS ON THE CONCEPT OF DESIGN FOR SAFETY (DFS) AMONGST DESIGN PROFESSIONALS IN THE CONSTRUCTION INDUSTRY IN NIGERIA

Mu'awiya Abubakar<sup>1</sup>, Bello Mahmud Zailani<sup>2</sup> and Abdulgafar Adamu<sup>3</sup>

<sup>1,2,3</sup>*Department of Building, Ahmadu Bello University, Nigeria*

Designing for construction safety entails safety considerations of construction workers and end users in the design of a project with a view to improve safety performance in construction project delivery. Despite the apparent potential benefits of Design for Safety (DfS) in curbing the persistent safety hazards and accidents faced in the conduct of construction activities, little or no effort has been made in most developing countries including Nigeria to ensure its wide adoption and implementation. This has been argued to be largely due to the dogmatic attitude of such developing industries towards conventional safety support systems and mechanisms. Thus, with a view to put the argument into clearer perspective, and also set the scene for effective DfS implementation in Nigeria, this study aimed to assess the level of awareness and readiness of professionals towards accepting the concept of DfS, and the possible changes that need to be made in the industry to facilitate its implementation. A quantitative research approach was adopted using a structured questionnaire to elicit data from randomly sampled professionals often involved in design for construction projects in the Nigerian construction industry. Data collected was analyzed using descriptive statistical methods. Findings of the study showed a relatively low level of awareness on the concept of DfS amongst industry professionals, and the need to constitute safety training programs which will go a long way in changing the perception of the design professionals towards safety. This will provide them with deeper insight on the contemporary trends in safety management tools and techniques for an improved safety performance.

Keywords: awareness, construction industry, design for safety (DfS), Nigeria, professionals

---

<sup>1</sup> muawiyaabubakar1@gmail.com, Tel. +2348067814149

<sup>2</sup> bellomahmud34@gmail.com

<sup>3</sup> adamuabulgafar@gmail.com

## INTRODUCTION

Over the years, there has been a great concern on the need for the construction industry around the globe to improve its safety performance in project delivery (Awwad et al., 2016; Kheni et al., 2008; Sawacha et al., 1999; Törner & Pousette, 2009). The global construction industry has been often regarded as a dangerous industry which holds a bad reputation among other industries for its high fatalities and injuries (Fang et al., 2004; Williams et al., 2020; Zhang et al., 2013). According to International Labour Organisation (ILO, 2005), one in six fatal accidents at work occur on a construction site, and that no less than 60,000 fatal accidents occur on construction sites around the world every year. This Poor safety performance recorded in the construction industry as compared to other industries has been often attributed to certain factors such as the fragmented and complex environment on construction sites, difficulties in managing risk on an ever-changing site, and the multifaceted networks of members on the project team, each with their own goals and objectives (Abubakar et al., 2020; Leung et al., 2010; Sawacha et al., 1999).

Furthermore, inadequate safety consideration in design has also been highlighted to be the major source of safety hazards and accidents (Behm, 2005) as it is widely believed that design forms the blueprint of all construction activities. The design defines the configuration and components of a facility and thereby influences, to a large extent, how the project will be constructed and the consequent safety hazards (Gambatese, 2000; Jeelani et al., 2017). Several studies around the globe support this argument with glaring numbers. Notably, Behm, (2005) noted that the lack of planning and design decisions in the construction industry in Australia was found to have influenced 63% of fatalities, whereas 42% of construction fatalities in the United States could be linked to inadequate safety consideration in design. These numbers show an urgent need to address the safety challenges in the design of construction projects.

The notion that the safety of construction activities can be increased through better design is both intuitively appealing and supported by research indicating that better planning, scheduling, and design could reduce hazards on construction worksites (Atkinson & Westall, 2010). Design for construction safety as an intervention is supported by the hierarchy of controls common to the safety and health professions which identifies designing to eliminate or avoid hazards as the preferable means for reducing risk (Manuele, 1997). The concept involves the practice of anticipating and "designing out" potential occupational safety and health hazards and risks associated with new processes, structures, equipment, or tools, and organizing work, such that it takes into consideration the construction, maintenance, decommissioning, and disposal/recycling of waste material, and recognizing the business and social benefits of doing so. It involves eliminating the need to control safety hazards and risks during work operations (Korman, 2013).

Although the design community has not come very far in terms of implementing safety-in-design, recognition of and interest in design for safety across the construction industries in world is growing. Several regulatory bodies across the globe such as American Society of Civil Engineers (ASCE), the United Kingdom's Construction Design and Management Regulations (CDMR), as well as the South

African Construction Regulations (SACR), are starting to set strict policies to ensure safety considerations in design. However, little or no effort has been made in most developing countries including Nigeria to ensure the wide practice of safety considerations in design (Kolo, 2015; Okeola, 2009). This begs the question on the viability of DfS practice in the construction industry in Nigeria, as implementation can only be achieved when the viability of the concept has been ascertained. In this regard, this study set out to serve as a footing for effective DfS implementation by assessing the awareness and readiness of professionals towards accepting the concept, and the changes that need to be made in the industry to facilitate its implementation.

## **LITERATURE REVIEW**

### **Safety issues in the construction industry**

The global construction industry has remarkably evolved over the years, with significant stake in economic development through infrastructure projects (Okeola, 2009; Oladinrin et al., 2012). Despite this stride, issues regarding operational safety still plagues the industry. This according to Abdul Hamid, Abd Majid, and Singh (2008) is largely due to the fact that safety performance is given less priority amongst other performance measures such as time, cost and quality. Trinh and Feng (2020) opined that ensuring safety in construction might seem a challenging task due to diversity, complexity, and extensive scope of works involved in the industry. A survey conducted by the Centre to Protect Worker's Rights (CPWR) showed that just a few industries across the globe recorded a higher rate of occupational injuries and fatalities than the construction industry in 2005. Regardless, Ayomoh and Oke (2006) argued that setting up of an effective safety system poses to prevent or minimize the occurrences of accidents and hazards that threaten work operations. Previous works have provided evidence that safety hazards can be controlled, and accidents can be prevented through the implementation of basic safety practices leading to a sound safety program (Abubakar et al., 2020; Albert et al., 2017; Hallowell et al., 2013; Sawacha et al., 1999).

### **Safety dynamics in the Nigerian construction industry**

Despite the socio-economic benefits derived from the construction industry in Nigeria (Isa et al., 2013; Oladinrin et al., 2012), the safety dynamics in the industry has been deplorable (Agbede et al., 2016). The construction industry employing the largest labour force in developing countries such as Nigeria has been noted to account for a relatively high number of all occupational injuries and fatalities resulting from accidents on work sites (Arumugam & Thirumurthy, 2007). Adeogun and Okafor (2013) observed that the industry consistently lags behind in the adoption and implementation of contemporary safety practices that pose the potential of yielding positive benefits. Evidently, there are evidences of safety legislations and policies that guide the execution of construction activities in Nigeria. Regardless, Diugwu et al. (2012) observed that there is a very low compliance to the stated safety laws and regulations in the country. Idoro (2004) also linked the country's poor safety status to lack of concern, lack of accurate records and poor statutory regulations.

However, Adeyemo & Smallwood (2017) argued that an improvement in legislation, and the adoption of novel practices has the potential of mitigating the occurrences of accidents and injuries on construction sites. The study posits that there should be new safety paradigm that would meet the present-day construction hazard through the enforcement of safety legislation, and the adoption of contemporary and sustainable safety practices. An innovative approach to the management of safety challenges in the construction industry is therefore required, which needs to be specific, monitored and enforced.

### **Design for construction safety**

The concept of design for safety can be traced far back to the 1800s manifesting through safer designing and implementation of guards for machinery; and subsequently ergonomic design of workstations (Schulte et al., 2008). However, Behm (2005) noted that it wasn't until the year 1985 that the International Labour Organization (ILO) proposed the idea that designers should be enforced to consider safety issues in their respective designs. Design for construction safety entails procedures in which the safety and health of construction workers are clearly taken into account by designers during the design process. Taiebat and Ku (2011) consider it as a design method which takes into account the cost, schedule and quality goals of a project while still considering safety issues. Overall, it can be regarded as the practice of anticipating and "designing out" potential occupational safety and health hazards and risks associated with new processes, structures, equipment, or tools, and organizing work, such that it takes into consideration the construction, maintenance, decommissioning, and disposal/recycling of waste material, and recognizing the business and social benefits of doing so.

There are evidences that academic efforts in previous years have significantly changed the safety practices in several construction environments. Many European Union (EU) countries have structured legislation with regards design for safety. Aires et al. (2010) studied the effect of such legislations on the safety performance of respective construction environments. It was observed that within a span of a decade, countries have experienced averagely 10% reductions in work place accident rates. Relatedly, a study conducted in the UK indicated that safety considerations in design has the potential to significantly reduce the risk associated with design in construction accidents (Haslam et al., 2005).

Overall, Manuele (2008) argued that one of the best ways to prevent and control occupational injuries, illnesses, and fatalities is to "design out" or minimize hazards and risks early in the design process. Thus, it becomes paramount to adopt apt consideration of safety issues right from the design and planning stage of construction projects considering the fretting safety challenges plaguing the construction industry in Nigeria and the broader global context towards an improved performance as opined by (Farooqui et al., 2008).

## **METHODOLOGY**

The quantitative methodological approach for research was adopted to achieve the aim of the study which was focused on assessing the level of awareness of construction designers in Nigeria on the concept of design for safety. A two-section questionnaire was designed to elicit data from industry professionals often

involved in construction related designs as respondents to the study. The reason for selecting this research instrument is because it allows the researcher to specify a measurement procedure in detail in order to define the quantity of a variable (Lavrakas, 2008). The first section of the questionnaire inquired about the demographic nature of the respondent, while the second section inquired about the respondent's level of awareness on the concept of DfS, and prior safety trainings in that regard. The respondents were sampled from the broad population of design professionals (Architectural, Structural, and Mechanical) in the Nigerian built environment, which at the time of collecting the data for this study there were 49, 842 registered design professionals in Nigeria drawn from the databases of regulatory bodies in respective professions. Subsequently, the formula derived by Anguila and Gonzalez-ramirez (2013) was used to determine the sample size methodically resulting in a sample size of 138. However, only 131 valid responses were gotten and analyzed using descriptive statistical techniques.

$$SS = \frac{Z^2 * (p) * (1-p)}{c^2}$$

Where; SS = Sample Size

Z = Confidence Level

P = Estimated variation of population

C = Standard error

$$\frac{1.96^2 * (0.1) * (1-0.1)}{0.05^2} = 138$$

## DATA ANALYSIS AND DISCUSSION

### Characteristics of respondents

Characteristic nature of the respondents and the nature of work they were involved in was enquired to define the context of the study findings. Table 1 present the professional background, years of experience and nature of work engaged by the respondents respectively. A large percent of respondents in the study had Architectural and Civil engineering background, which accounted for forty-eight percent (48%) and forty-one percent (41%) respectively. Electrical engineers constituted eight percent (8%) of the respondents, while only three percent (3%) of the respondents were Mechanical Engineers. With regards to the years of experience of the respondents, majority had professional experience ranging from 6-10 years which constituted forty-percent (42%) of the total respondents, while thirty-eight percent (38%) had professional experience spanning less than five (5) years. Years of experience ranging from 11-15 years, and 16-20 years represented eight percent (8%) of the respondents respectively, while respondents having over twenty (20) years of experience representing four percent (4%) of the study population. This shows a relative involvement of a wide spectrum of experienced professionals in the study which broadens the perspective and context of the study findings.

**Table 1: Professional background**

Professional Background	Years of Experience	
	Frequency	Percentage
Architect	63	48
Civil/ Structural engineer	54	41
Mechanical engineer	4	03
Electrical engineer	10	08
Total	131	100

**Nature of Job**

	Frequency	Percentage
Building works	70	53
Civil works	10	08
Building and Civil works	51	39
Total	131	100

More so, Bamisile (2004) noted that construction activities are often broadly categorized into building works and civil works. Building works involves the construction of general building infrastructure that include residential, schools and hospitals etc. whereas, civil works involves broad civil engineering works that span across large construction projects that include dams, bridges, roads etc. The classification of respondents in this study shows that majority of them were engaged in only Building works representing fifty-three percent (53%), while eight percent (8%) were engaged in only Civil works. Thirty-nine percent (39%) of the respondents were engaged in both Building and Civil works. This result gives an insight on the dynamic involvement of the respondents in the construction industry, which may influence their overall awareness on the study construct.

**Awareness on the concept of Design for Safety**

Questions regarding the level of awareness on the concept of Design for safety were asked, and the subsequent sections provides the key findings of the study. Respondents were asked whether they had any prior knowledge on the concept of Design for Safety from their dynamic engagements in the construction industry., and Figure 1 highlights their respective responses.

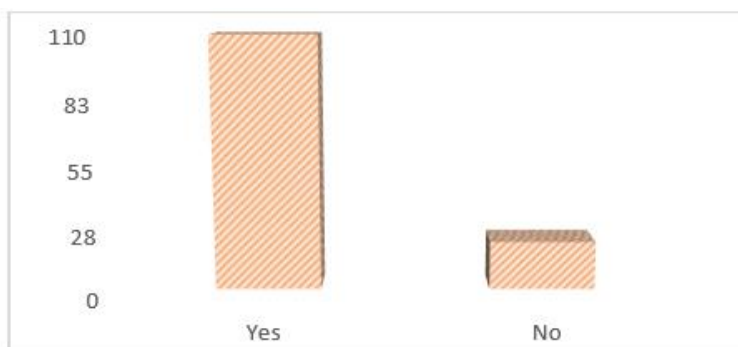

Figure 1: Prior knowledge on Design for Safety



Although a large majority of the respondents representing 84% reported having prior knowledge on the concept, findings presented in Figure 2 show that majority of these respondent only became aware of the concept in recent years with 53% percent learning about it in the last 5 years.

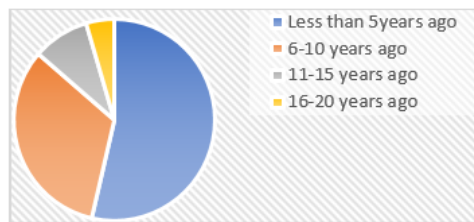

Figure 2: First Learnt about the concept

Basaga et al. (2018) observed that safety training is a fundamental tool used across industries in shaping the safety perception of individuals involved in diverse job tasks. Workers previously engaged in safety training often have more awareness on various safety tools and techniques, and are reported to apply these tools and techniques in the execution of their professional duties. Based on this assertion, respondents were asked on whether they have been involved in a safety training programme. As shown in figure 3, it was observed that only 44% of the respondents had prior safety training, with a large majority representing 61% reporting not ever been engaged in a safety training programme over the course of their respective professional careers.

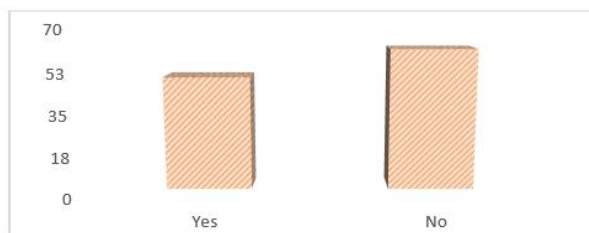

Figure 3: Prior engagement in a safety training programme

Relatedly, when asked about the perceived level of understanding on the concept of design for safety in construction, a large percentage of the respondents representing 43% and 24% responded having a relatively good and fair understanding of the concept respectively. Only 16.8% of the respondents believe they have a very good grasp of the concepts, and its application in the construction industry, with just below 12% reporting poor understanding of the concept.

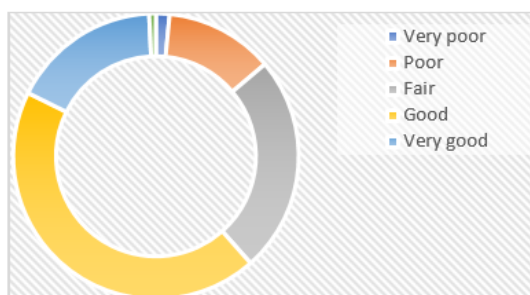

Figure 4: Perceived Level of understanding on Design for Safety

More so, the level of significance attached to safety considerations across distinct design professionals in the industry was assessed. Although the fundamental considerations in the design of building infrastructure are functionality and aesthetics (Best & Valence, 2007), 96.15% of the respondents in this study noted the high significance of safety considerations in the design of functional and aesthetical structures. However, only 71.7% of the civil engineering designers often involved in the design of structural elements of infrastructure developments regard so much importance in considering safety in design, with 7.55% feeling its fairly important. Whereas, 100% of the services engineers reported regarding safety in design as very important. This could be attributed the fact that failure in safe execution of such designs often result in high-risk safety hazards (Greenwald, 1991).

**Table 2: Importance of Design for Safety**

Profession	Extent of importance you attach to considering the safety of construction in design stage		
	Very important %	Important %	Fairly important %
Architects	96.15	3.85	0
Civil/ Structural engineers	71.70	20.75	7.55
Mechanical engineers	100	0	0
Electrical engineers	100	0	0

## DISCUSSION

This study adds to the exiting body of knowledge in the area of assessing the viability of diverse and novel safety management tools and techniques that have the potential of curbing the incessant safety challenges facing the global construction industry at large. Although the evolution of the design for safety concept can be traced far back to the 1800s (Schulte et al., 2008), findings of this study showed that most of the design professional only became aware on the concept of Design for Safety in the last few years. This presents additional evidence on the dogmatic attitude of the construction industry in Nigeria towards conventional safety methods, and the nonchalance towards the promotion and adoption of conventional methods. Despite being a party to the Geneva Occupational Safety and Health Convention 1981, the construction industry in Nigeria continues to lag behind in the implementation contemporary safety practices (Adeogun and Okafor, 2013) towards improving the safety performance of the industry.

More so, as largely seen in various developing countries (Awwad et al., 2016; Kheni et al., 2008), a handful of the design professionals in the Nigerian built environment have had no prior safety training. This as argued by Basaga et al. (2018) has the potential to limit their awareness and understanding of novel safety management tools and techniques, which manifest in their abysmal safety performance. Furthermore, it could be seen from the study findings the majority of the design professionals in Nigeria do attach significance importance to safety considerations in design. However, it was observed that fraction of the civil engineers fail to regard safety consideration in design as a fundamental professional practice despite its

severe consequences. Similar nonchalant attitude of professionals towards safety in the construction industry could be argued to be a major contributor to the continuous building collapse in the country largely due to structural failure. This attitude amongst professionals as argued by Idoro (2004) as a manifestation of lack in safety regulation in the Nigerian construction industry which could promote sustainable safety practices.

## CONCLUSION

This study assessed the level of awareness on the concept of design for safety amongst design professionals in the Nigerian built environment with a view to improve their overall safety performance. This became paramount considering the fretting data on construction accidents and fatalities in countries like Nigeria with little or no safety regulations, and the assertions from broad safety management literature on the significant value in taking safety measures right from the design and planning stages of construction activities. Based on the findings of the study, it is recommended that the enforcement of safety regulations be improved, and safety training Programs be constituted that will mandate design professionals to actively engage in safety practices. This will go a long way in changing the perception of the design professionals, especially the civil/structural engineers towards safety, and provide them with deeper insight on the trends in safety management tools and techniques for an improved performance.

## REFERENCES

- Abubakar, M., Ibrahim, Y. M., Bala, K., & Ibrahim, A. D. (2020). Identifying the Factors Influencing Hazard Recognition Capability of Construction Workers. *Construction Research Congress 2020*, 268–278.
- Adeyemo, O., & Smallwood, J. (2017). Impact of Occupational Health and Safety Legislation on Performance Improvement in the Nigerian Construction Industry. *Procedia Engineering*, 196(June), 785–791.
- Agbede, J. O., Manu, P., Agbede, O. A., & Mahamadu, A.-M. (2016). Health and safety management practices in the Nigerian construction industry: A survey of construction firms in South Western Nigeria. *Proceedings of the CIB World Building Congress 2016*, 2, 293–304.
- Aires, M., Gamez, R., & Gibb, M. C. (2010). Prevention through design: The effect of European Directives on construction workplace accidents. *Safety Science*, 48(2), 248–258.
- Albert, A., Hollowell, M. R., Skaggs, M., & Kleiner, B. (2017). Empirical measurement and improvement of hazard recognition skill. *Safety Science*, 93, 1–8.
- Arumugam, E., & Thirumurthy, A. (2007). *Benchmarking Studies on Safety Management in Construction Industries of India*.
- Atkinson, A., & Westall, R. (2010). The relationship between integrated design and construction and safety on construction projects. *Construction Management and Economics*.
- Awwad, R., El Souki, O., & Jabbour, M. (2016). Construction Safety Practices and Challenges in a Middle Eastern Developing Country. *Safety Science*, 83, 1–11.

- Ayomoh, M., & Oke, S. (2006). A Framework for Measuring Safety Level for Production Environments. *Safety Science*, 44(3), 221–239.
- Bamisile, A. (2004). *Building Production Management*. Foresight Press Ltd.
- Basaga, B. H., Temel, A. B., Atasoy, M., & Yildirim, I. (2018). A Study on the Effectiveness of Occupational Health and Safety Trainings of Construction Workers in Turkey. *Journal of Safety Science*, 110(June), 344–354.
- Behm, M. (2005). Linking construction fatalities to the design for construction safety concept. *Safety Science*.
- Best, R., & Valence, G. De. (2007). *Design and Construction*. Routledge.
- Fang, D. P., Huang, X. Y., & Hinze, J. (2004). Benchmarking Studies on Construction Safety Management in China. *Journal of Construction Engineering and Management*, 130(3), 424–
- Farooqui, R., Ahmed, S., & Azhar, S. (2008). Implementing a Pedestrian Safety System on Construction Work Sites. Sixth LACCEI International Latin American and Caribbean Conference for Engineering and Technology, 1–9.
- Gambatese, J. A. (2000). Safety constructability: Designer involvement in construction site safety. *Proceedings of Construction Congress VI: Building Together for a Better Tomorrow in an Increasingly Complex World*, 278, 650–660.
- Greenwald, E. (1991). *Electrical Hazards and Accidents: their cause and prevention*.
- Hallowell, M. R., Hinze, J. W., Baud, K. C., & Wehle, A. (2013). Proactive Construction Safety Control: Measuring, Monitoring, and Responding to Safety Leading Indicators. *Journal of Construction Engineering and Management*, 139(10), 04013010.
- Haslam, R., Hide, S., Gibb, A., Gyi, D., Pavitt, T., Atkinson, S., & Duff, A. (2005). Contributing Factors in Construction Accidents. *Applied Ergonomics*, 36(4), 401–415.
- ILO. (2005). *Facts on Safety at Work*. [www.ilo.org/safework](http://www.ilo.org/safework)
- Isa, R. B., Jimoh, R. A., & Achuenu, E. (2013). An Overview of the Contribution of Construction Sector to Sustainable Development In Nigeria. *Net Journal of Business Management*, 1(1), 1–16.
- Jeelani, I., Albert, A., & Gambatese, J. A. (2017). Why Do Construction Hazards Remain Unrecognized at the Work Interface? *Journal of Construction Engineering and Management*, 143(5).
- Kheni, N. A., Dainty, A. R. J., & Gibb, A. (2008). Health and Safety Management in Developing Countries: A study of Construction SMEs in Ghana. *Construction Management and Economics*, 26(11), 37–41.
- Kolo, D. N. (2015). *Safety Issues Involving Workers on Building Construction Sites in Nigeria: An Abuja Study (Issue February)*. Eastern Mediterranean University.
- Korman, T. M. (2013). Fire safety design and construction considerations for sustainable residential structures. *AEI 2013: Building Solutions for Architectural Engineering - Proceedings of the 2013 Architectural Engineering National Conference*, 624–632.
- Leung, M., Chan, Y.-S., & Yuen, K.-W. (2010). Impacts of Stressors and Stress on the Injury Incidents of Construction Workers in Hong Kong. *Journal of Construction Engineering and Management*, 136(10), 1093–1103.
- Manuele, F. (1997). *Principles for the practice of safety*. Professional Safety.

- Okeola, O. G. (2009). Occupational Health and Safety (OHS) Assessment in the Construction Industry. 1st Annual Civil Engineering Conference University of Ilorin, Nigeria, 26-28 August 2009, 26–28.
- Oladinrin, T., Ogunsemi, D., & Aje, I. (2012). Role of Construction Sector in Economic Growth: Empirical Evidence from Nigeria. *FUTY Journal of the Environment*, 7(1), 50–60.
- Sawacha, E., Naoum, S., & Fong, D. (1999). Factors Affecting Safety Performance on Construction Sites. *International Journal of Project Management*, 17(5), 309–315.
- Schulte, P., Rinehart, R., Okun, A., Geraci, C., & Heide, D. (2008). National Prevention Through Design (PtD) Initiative. *Journal of Safety Research*, 39(2), 115–121.
- Taiebat, M., & Ku, K. (2011). Design and planning for safety (DPfS); A factor modeling approach to find the best response to hazard. *AEI 2011: Building Integrated Solutions - Proceedings of the AEI 2011 Conference*, 437–447.
- Törner, M., & Pousette, A. (2009). Safety in construction—A Comprehensive Description of the Characteristics of High Safety Standards in Construction Work, from the Combined Perspective of Supervisors. *Journal of Research Safety*.
- Trinh, M. T., & Feng, Y. (2020). Impact of Project Complexity on Construction Safety Performance: Moderating Role of Resilient Safety Culture. *Journal of Construction Engineering & Management*, 146(2).
- Williams, J., Fugar, F., & Adinyira, E. (2020). Assessment of Health and Safety Culture Maturity in the Construction Industry in Developing Economies A case of Ghanaian Construction Industry. *Journal of Engineering Design and Technology*, January.
- Zhang, S., Teizer, J., Lee, J., Eastman, C., & Venugopal, M. (2013). Building information modeling (BIM) and safety: Automatic safety checking of construction models and schedules. *Automation in Construction*, 183–195.



# ASSESSMENT OF FACTORS RESPONSIBLE FOR OUTSOURCING OF FACILITIES MANAGEMENT SERVICES IN THE PUBLIC HOSPITALS WITHIN KADUNA METROPOLIS

Aliyu Suleiman Shika<sup>1</sup>, Mohammed Mustapha Saad<sup>2</sup> and Abdullahi Getso Ibrahim<sup>3</sup>  
<sup>1,2,3</sup>*Department of Building, Faculty of Environmental Design, Ahmadu Bello University Zaria-  
Nigeria*

Outsourcing is an increasingly popular strategy that healthcare organizations can use to control the rising costs of providing services. With outsourcing, an external contractor assumes responsibility for managing one or more of a healthcare organization's business, clinical, or hospitality services. Nigeria's public hospitals are not adequately equipped with the necessary best practice mechanisms to guide them in making right decisions regarding outsourcing of services while taking into consideration the likely risks that may be associated with such outsourcing transactions. This study assesses the factors responsible for outsourcing of Facilities Management Services in Public Hospitals within Kaduna Metropolis. The research was designed to assess the non-core facility management services outsourced in the selected hospitals. The population of the study were public hospitals within Kaduna metropolis. Convenience sampling technique was used in selecting the hospitals assessed. Data was collected using a well-structured questionnaires distributed to respondents. Descriptive statistics were utilized and data obtained was analysed with the aid of SPSS version 16. Results obtained from the analysis shows that though facility management services are outsourced in the assessed hospitals but it is as low as 29.63% while 62.965% of the services are being provided in-house and 7.41% are not rendered. Kaduna State Ministry of Health is encouraged to outsource more of the non-core services provided in-house in order to enable the state owned public hospitals focus more on their core services thereby improving their performance standard.

Keywords: assessment, facilities management services, hospitals, outsourcing, performance

## INTRODUCTION

Outsourcing is a procurement option that involves the "contracting-out" of services that were previously performed in-house to an external service provider as a means of increasing organisational efficiency and effectiveness (Monczeka, Carter, Markham, Blascovich & Slaight 2005). It is a strategy that many public sector

<sup>1</sup> asshika1@gmail.com; Tel: +2348100244837

<sup>2</sup> saadmustyfresh8@gmail.com

<sup>3</sup> getsomsc12012@gmail.com

agencies are embracing as a way of improving value for money in providing public services. Outsourcing describes the use of external resources to execute operational tasks (Weiner & Seuring 2009). In other words, it is transfer of various elements of work previously carried out within the company to another third party company. This process allows focusing on top and main functions of the company, adapting to new technologies, improving the reliability and market reputation and significantly reducing production costs (Weiner & Seuring 2009).

Health sector are of the view that public health care institutions are turning to outsourcing in an effort to maintain high standard of care and reduce cost of health provision while addressing economic realities (Ikediashi, 2015). This study noted that even though outsourcing is one of the most researched areas in management studies, its impact on facilities management services provision in public hospital setting of a developing economy like Nigeria is largely unclear (Ikediashi, 2015). While the strategic importance of out-sourcing is generally recognized, little is understood about its practice. The decision matrix of strategic sourcing presented in this paper provides a useful management tool for selecting the appropriate sourcing strategy. In addition, the ensuing discussion on the implementation process offers insights into the strategic and operational issues related to put specific sourcing strategies into practice Ancarani & Capaldo (2011), this therefore emphasises the need for this research which is to make facilities management s services delivery sustainable in our hospitals. In specific terms, this study proposes to address this by first identifying the drivers of outsourcing and then conduct an empirical survey of facilities management services being outsourced in the hospitals.

There are so many hospitals in Nigeria cutting across public and private. It is not possible considering all the limitations outlined above to cover all the hospitals. This explains why the research focuses on public state hospitals who in any case, even though make up 65% of the nation's hospitals (Ademiluyi & Aluko-Arowolo, 2009) but have a controlling share of approximately 92% of patient population in Nigeria's hospitals. However the homogeneity of the structure and running of public hospitals in Nigeria means that the outcome of this research can be generalised to all public state owned hospitals in Kaduna state. This research is aimed at assessing the factors responsible for outsourcing of facilities management services in the public hospitals within Kaduna metropolis. The objectives are to identify the factors influencing decision to outsource facilities management services in the hospitals, examine the facilities management services being outsourced in the hospitals and assess the quality of outsourced services in public hospitals

## **LITERATURE REVIEW**

### **Facilities management**

Facilities management as an evolving profession has been described by Yiu (2008) as one faced with a serious identity crisis. This is because there seem to be no consensus yet on what could be regarded as a clear and acceptable definition of facilities management. Instead, many of the definitions provided by authors shows widespread variance on the understanding of what facilities management is, how it operates and to what extent it offers sustainable opportunities for businesses

(Noor & Pitt, 2009). A few of the definitions commonly cited in the FM literature is as follows:

According to Becker (1990), "FM is responsible for co-ordinating all efforts relating to planning, designing and managing buildings and their systems, equipment and furniture to enhance the organization's ability to compete successfully in a rapidly changing world." On its own part, IFMA (2007) defines facilities management as "The practice of coordinating the workplace with the people and work process of the organisation; integrating the principle of business administration and the behavioural and engineering sciences."

#### Facilities management services

According to Price (2006): "The facility management (FM) industry can be broadly divided into three categories: facility managers, specialist consultants and service providers. Facility managers are responsible for particular facilities either for one organization or on behalf of a number of organizations and function largely at a strategic level. Specialist consultants provide targeted expertise in areas as diverse as architectural, structural, fit-out, services and landscape design, cost management, project management, environmental assessment, due diligence, energy planning and dispute resolution, and function largely at a tactical level.

Service providers include cleaning contractors, insurers, furniture suppliers, security, construction, catering, fleet management and a range of other support services, and function largely at an operational level." The description above could be further aligned into 11 competencies put forward by the International Facilities Management Association. According to IFMA (2011), they are communications, quality management, technology, operations and maintenance, human factors and finance and business. Others include emergency planning and business continuity, leadership and strategy, real estate and property management, project management, environmental stewardship and sustainability.

#### **Outsourcing strategies in facilities management**

According to Ikediashi and Mbamali (2014) Outsourcing has been variously defined by researchers as the procurement option that favours 'contracting out' of services previously performed in-house to an external service provider as a means of increasing organizational efficiency and effectiveness. Their study further portray that outsourcing involves a legal relationship between an organization and an external provider for the purpose of contracting out services which were previously performed by in-house staff. Accordingly, Ancarani & Capaldo (2011) states the several strategies available for Facilities Management. These options include:

##### ***In-house:***

This is where a service is provided by a dedicated resource directly employed by the organisation even though the monitoring and control of performance is conducted under the terms of conventional employer/employee relationship.

##### ***Outsourcing:***

This is where a service is commissioned from an external supply organisation usually under the terms of a formal contractual arrangement based upon terms and conditions derived from a service level agreement.



***Public private partnership (PPP):***

A form of partnership or strategic alliance is formed between the organisation and service provider based on a sharing of the responsibility for the delivery and performance of the service, including the sharing of the profits.

***Total facilities management (TFM):***

Here a whole range of services are bundled together and externalized to a single supplier which becomes totally responsible for the delivery, monitoring, control and attainment of stated performance objectives in the contract.

According to Kurdia et al, (2011), most buildings nowadays are still practicing conventional management which includes a small organization or team in one department. They only pay attention towards the performance of the facilities and services of the building such as the maintenance department where they make sure all the equipment and services is functioning all the time. Facilities management can be used to help businesses maximize returns on investment and establish long term competitive advantages in the marketplace. It is necessary for business to achieve maximum output from their facilities in order to reduce building life-cycle costs and maximize profits. The traditional approach to outsourcing cannot be the best sourcing strategy under all circumstances. Out-tasking is an alternative option that may be more appropriate in specific situations. This latter approach is widely practiced in information technology and facilities management. While the strategic importance of out-tasking is generally recognized, little is understood about its practice. The decision matrix of strategic sourcing presented in this paper provides a useful management tool for selecting the appropriate sourcing strategy. In addition, the ensuing discussion on the implementation process offers insights into the strategic and operational issues related to put specific sourcing strategies into practice (Encon, Albert, 2004)

**FM Services in hospitals management**

Within the context of hospital management, FM has continued to live by its definition of creating the right enabling environment that supports the core mandate of rendering clinical and medical diagnostic services; which is why Shohet and Lavy (2004) considered healthcare FM as one of the key elements for the successful delivery of healthcare services. Essentially, one can contend that FM adds value to hospital through achievement of zero defects in the hospital's physical operations, especially in very delicate areas where very minute problems can have huge and devastating consequences and could be a matter of life and death. Other areas of benefit of FM services to healthcare delivery in hospitals include management of infrastructure facilities such as estate and property, indoor air, structure and fabric, water supply, electricity and telecommunication management referred to as hard FM; and catering, cleaning, waste management, security and laundry services described as soft FM (Liyanage and Egbu, 2008).

**RESEARCH METHODOLOGY**

The research was conducted through administering of questionnaires and review of literature. The literature review was carried out through the use of books and journals to source for information on the subject matter. The targeted populations for this research were heads of works, directors of finance, heads of procurements,

directors of administration, hospital secretaries, medical directors and a chief medical director of state owned hospitals within Kaduna metropolis. The participants were selected through convenience sampling technique.

The total population for the study are thirty six (36) heads of various units in the assessed hospitals. According to (Rose 2015) an element can be selected from target population because of its convenience to researcher and its time and costs saving. In respect to these samples for this research were collected from the six state owned hospitals within Kaduna metropolis. In selecting each of the six (6) assessed hospitals, convenience sampling technique was used in selecting the respondents in the selected hospitals because it is convenience to researcher and its time and costs saving.

A well-structured questionnaire was designed with sections: A, B, C, D and E respectively and self-administered to heads of departments in the selected state owned hospitals within Kaduna metropolis. In analyzing the data for this study, descriptive statistics was used through the use of descriptive statistics with the aid of SPSS version 16. Results were presented by the use of Percentage Tool/Method, some of the questions in the questionnaire involve assessing some of the indices on a five (5) Likert's scale. That is Strongly Disagree, Disagree, Agree, and Strongly Agree and also Poor, Fair, Average, Good and Excellent.

The research question for this study therefore is: Why are public hospitals deciding to outsource facilities management services?

In order to address this question, the study addresses the following questions raised by the study:

1. What are the factors that influence the decision to outsource facilities management services?
2. What are the facilities management services being outsourced by the public hospitals?
3. What is the perception of users on the quality of services rendered by vendors in the hospitals?

### **Reliability and validity**

Reliability according to Easterby-Smith et al. (2008) is the extent to which the data collection and analytical techniques yield consistent findings. Alpha values greater than 0.7 are regarded as sufficient (Pallant, 2004; Chan, 2005). To demonstrate the reliability of scales for ranking outsourcing decision, Cronbach's coefficient was used to examine the internal consistency of the scales. All the values were above the 0.7 threshold (see table below) indicating the scale for this study are reliable.

### **Reliability statistics result**

Item description	Cronbach's alpha	Number of items
Outsourcing decision factors	0.780	31

## DATA PRESENTATION AND DICUSSION

**Table 1: The Respondents' position in the organization**

S/No	Position	Responses (No)	Percentages of Responses (%)
1.	Chief Medical Director	1	3.13
2.	Medical Director	4	12.50
3.	Head of Administration	5	15.63
4.	Head of Finance	6	18.75
5.	Head of Works	5	15.63
6.	Head of Procurement	5	15.63
7.	Hospital Secretary	6	18.75
E	TOTAL	32	100

Table 1 shows that 3.13% of the respondents held the position of a Chief Medical Director, 12.50% were Medical Directors, Head of Administrations, Heads of Works and Heads of procurements covered 15.63% each while Heads of Finance and Hospital Secretary positions held 18.75% each.

**Table 2: Respondents' professional affiliation**

S/No	Profession	Responses (No)	Percentages of Responses (%)
1.	Medical Consultant	1	3.13
2.	Medical and Dental Council of Nigeria	4	12.50
3.	Public Administrator	5	15.63
4.	Accountant	4	12.50
5.	Business and finance	2	6.25
6.	Quantity Surveyor	4	12.50
7.	Purchasing and Supply	1	3.13
8.	Builder	2	6.25
9.	Civil Engineer	3	9.38
10.	Office Management	6	18.75
	TOTAL	32	100

Table 2 shows that 3.13% of the profession of the respondents was a Medical Consultant, 12.50% were registered with Medical and Dental Council of Nigeria, 15.63% were Public Administrators, 12.50, 6.25% and 12.50% were Accountants, Business Finance and Quantity Surveyors respectively. 3.13% had Purchasing and Supply. 6.25% of the respondents were Builders while 9.38% were also Civil Engineers. 18.75% were Office Managers.

**Table 4.3: Respondents' academic qualification**

S/No	Qualification	Responses (No)	Percentages of Responses (%)
1.	Higher National Diploma	8	25
2.	Bachelor of Science	11	34.37
3.	Masters of Science	9	28.13
4.	Doctorate Degree	1	3.13
5.	Postgraduate Diploma	3	9.38
	TOTAL	32	100

Table 4.3 reveals that 25% of the respondents have Higher National Diploma, 34.37% have Bachelor of Science, 28.13% had Masters of Science, 3.13% had Doctorate Degree while 9.38% had Postgraduate Diploma.

**Table 4.4: Respondents' years in service**

S/No	Years in Service	Responses (No)	Percentages of Responses (%)
1.	1- 5 Years	4	12.5
2.	6-10 Years	14	43.75
3.	11-20 Years	90	28.13
4.	21-30 Years	5	15.63
5.	TOTAL	32	100

Table 4.4 shows the respondents 'number of years in service. 12.5% are within 1-5 years in service, 43.75% are within 6-10 years in service, 28.13% are within 11-20 years in service while 15.63% are within 21-30 years in service.

### Hospital Characteristics

This section was designed to inquire from the respondents, specific information about the ownership structure of the hospital they work. It also enquires about the category of the hospital as well as the kind of contractual arrangement the managements have with vendors. The results of the analysis are tabulated in table 4.5, 4.6 and 4.7 as shown below:

**Table 4.5: Ownership structure of hospital**

S/No	Ownership Structure	Responses (No)	Percentages of Responses (%)
1.	State	32	100
	TOTAL	32	100

Table 4.5 shows that 100% of the respondents work in State owned hospitals.

**Table 4.6: Categorization of hospital**

S/No	Category	Responses (No)	Percentages of Responses (%)
1.	Tertiary/ Teaching Hospital	1	3.13
2.	Secondary/ General Hospital	31	96.88
	TOTAL	32	100

Table 4.6 shows the categories of hospitals the respondents work. 3.13% of the respondents work in Tertiary/ Teaching Hospital while 96.88% work in Secondary/ General Hospitals.

**Table 4.7: Contractual arrangements with vendors**

S/No	Category	Responses (No)	Percentages of Responses (%)
1.	Managing Contractor	31	96.88
2.	Solely Government Funding	1	3.13
	TOTAL	32	100

Table 4.7 shows the contractual arrangement of the hospital managements and vendors. It shows that 96.88% arrangements are with Managing Contractors while 3.13% was solely government funding.

**Table 4.8: Factors influencing decision to outsource FM services in table**

Outsourcing Decision factors	Response					Sum	Mean	Standard Deviation	Ranking
	1	2	3	4	5				
<b>Cost Related Factors</b>									
To make cost transparent			1	5	26	153	4.80	4.80	3 <sup>rd</sup>
To reduce investments in assets			4	12	16	140	4.38	4.43	5 <sup>th</sup>
To reduce invested capital funds in non-core functions				4	28	156	4.88	4.88	1 <sup>st</sup>
To access vendor's cost efficient system.			2	12	18	142	4.44	4.54	4 <sup>th</sup>
To achieve cost reduction with enhanced performance of services				4	28	156	4.88	4.88	1 <sup>st</sup>
To focus on core competencies				3	29	157	4.91	4.91	2 <sup>nd</sup>
To improve on strategic positioning.			6	2	24	146	4.60	4.63	6 <sup>th</sup>
To increase flexibility				2	30	158	4.94	4.94	1 <sup>st</sup>
To multiply sourcing in case of uncertainties			6	12	14	136	4.25	4.32	7 <sup>th</sup>
To handle varying demand more effectively			12	6	14	130	4.10	4.16	8 <sup>th</sup>
Restricted by insufficiency in own resources			20	4	8	116	3.63	3.72	10 <sup>th</sup>
To compare performance of in-house staff with vendor's workers			15	10	8	125	3.91	3.87	9 <sup>th</sup>
To play along with the trend in privatization			2		30	156	4.88	4.89	3 <sup>rd</sup>
To share risks				5	27	155	4.84	4.85	5 <sup>th</sup>
To limit size of staff				4	28	156	4.88	4.89	4 <sup>th</sup>
<b>Innovation Related Factors</b>									
To gain access to new products, services and technologies			2	5	25	151	4.72	4.75	4 <sup>th</sup>
To obtain skills, expertise and ideas				5	27	155	4.84	4.86	3 <sup>rd</sup>
To obtain technologies not available in-house				2	30	170	5.31	4.94	1 <sup>st</sup>
To stimulate innovation among personnel			2	10	20	146	4.60	4.60	5 <sup>th</sup>
To permit quicker response to new needs				4	28	156	4.88	4.89	2 <sup>nd</sup>
<b>Quality Related Factors</b>									
To improve performance standard				2	30	158	4.94	4.94	1 <sup>st</sup>
To improve quality of service to users				4	28	156	4.88	4.89	2 <sup>nd</sup>
To improve mutual trust between hospital and customers			11	3	18	135	4.22	4.32	3 <sup>rd</sup>
<b>Time Related Factors</b>									
To improve timely delivery of service				2	30	158	4.94	4.94	1 <sup>st</sup>
There's not enough time to acquire tools and techniques in-house			6	5	21	143	4.47	4.54	3 <sup>rd</sup>
To improve process responsiveness and cycle times				4	28	156	4.88	4.89	2 <sup>nd</sup>
<b>Service to Community</b>									
To improve on stakeholders' satisfaction				4	28	156	4.88	4.89	1 <sup>st</sup>
To improve customer relation				7	25	153	4.78	4.79	3 <sup>rd</sup>
To improve labour relations				6	26	154	4.81	4.83	2 <sup>nd</sup>
To improve on corporate social responsibility of the hospital			2	10	20	146	4.60	4.60	5 <sup>th</sup>
To create jobs for local communities				12	20	148	4.63	4.65	4 <sup>th</sup>

Table 4.8 listed out the factors such as cost, strategy, innovation, quality, and time related factors as well as service to community influence the decision to outsource FM Services in the assessed hospitals using a five (5) point Likert scale of 1=Strongly disagree, 2=Disagree, 3=Average, 4=Agree, 5= Strongly agree..

From the table, the highest ranked cost related factor is to reduce invested capital funds in non- core functions and to achieve cost reduction with enhanced performance of service both having the standard deviation of 4.88. The lowest ranked have the standard deviation of 4.43 which factor is to reduce investment in assets.

For strategy related factor, improving on strategic positioning is the highest rank with a standard deviation of 4.94 followed by focus on core competencies with the standard deviation of 4.91. The lowest ranked factor have a standard deviation of 3.72 which is restricted by insufficiency in own resource. Innovative related factor have the highest ranked factor with a standard deviation of 4.94 which is to obtain technologies not available in-house. The lowest rank under this factor is to stimulate innovation among personnel having a standard deviation of 4.60.

Quality related factor have the highest ranked standard deviation of 4.94 which is to improve performance standard. The 2nd ranked have the standard deviation of 4.89 which is to improve quality of service to users. The 3rd ranked factor is to improve mutual trust between hospital and customers with a standard deviation of 4.32.

To improve timely delivery of service is the highest ranked with 4.94 as standard deviation in time related factor. The lowest ranked is no enough time to acquire tools and techniques in-house with standard deviation of 4.89.

Service to community factors have the highest ranked with standard deviation 4.89 which is to improve stakeholders satisfaction. To improve social cooperate responsibility is the lowest ranked with a standard deviation of 4.60.

**Table 4.9: Facilities management services being outsourced in table**

Facilities Management Services	Outsource (%)	In- House (%)	Not Applicable (%)
Real Estate/ Property Management			
Real estate/property portfolio management	6.25	93.75	0
Leasing and sub-letting services	0	75	25
Retail outlets and space renting	21.88	78.12	0
Extension and alterations	87.50	12.50	0
Demolitions	88	22	0
Maintenance and Repairs			
Facility refurbishment	87.50	12.50	0
Plant maintenance and repairs	21.88	78.12	0
General cleaning services	6.25	93.75	0
Waste disposal and environmental management	6.25	93.75	0
Health and safety management	15.60	84.40	0
Landscaping maintenance	21.88	78.12	0
Administration Management and Office Services			
Security	12.50	87.50	0
Courier services	93.75	0	6.25
Storage and distribution of medical supplies	6.25	93.75	0

**Table 4.9 Contd.: Facilities management services being outsourced in table**

Reception and telephone operator	0	78.13	21.87
Public relation/liaison services	0	93.75	6.25
Travel arrangements	78.13	21.87	0
Car park maintenance	6.25	93.75	0
Purchasing and contract control and negotiation	78.13	0	6.25
Office furniture and stationary provision	93.75	6.25	0
Human resource management	0	100	0
Employee Support Services			
Child nursery administration	0	18.75	81.25
Recreations	0	93.75	6.25
Catering/Restroom management	87.50	12.50	0
Residential accommodation	6.25	93.75	0
Community affairs	0	93.75	6.25
Management of employees with special	0	87.50	12.50

Table 4.9 shows the outsourced FM services in based the respondents response are: extension and alteration with 87.5%, demolition 88%, facility refurbishment 87.5%. Courier service 93.75%, travel arrangement and Purchasing and contract control and negotiation with 78.13% respectively. Office furniture and stationary provision 93.75% while Catering/Restroom management had 87.50%.

Table 4.10 analyses the quality of the outsourced FM services in the assessed hospitals using a five (5) point Likert scale of 1=Strongly disagree, 2=Disagree, 3=Average, 4=Agree, 5= Strongly agree.

Quality of outsourced FM services in the hospitals assessed, facility refurbishment and attitude of personnel have competence as highest ranked with standard deviation of 4.74, the lowest ranked quality factor here has a standard deviation of 4.12 which is responsiveness

For contract control and negotiation services, the highest ranked quality factor is competence with a standard deviation of 4.79 while the lowest ranked have a standard deviation of 4.49 which is attitude and courtesy of personnel.

Extension, demolition and alteration services have attitude and courtesy of personnel as the highest ranked quality factor with a standard deviation of 4.79, the lowest ranked factor here is 4.49 which is responsiveness.

Travel arrangement services have the highest ranked quality as competence with the standard deviation of 4.62 and lowest ranked factor as reliability and responsiveness with standard deviation of 4.27 respectively.

Catering services have the highest ranked factor as competence having the standard deviation of 4.79 and the lowest factor have standard deviation of 4.37 which is reliability.

**Table 4.10: Quality of outsourced services in public hospitals**

Facilities management services	Response					Sum	Mean	Standard Deviation	Ranking	
	1	2	3	4	5					
Facility Refurbishment Services and their personnel										
Attitude and courtesy of personnel			4	18	10	134	4.19	4.24	3 <sup>rd</sup>	
Reliability(dependable and accurate service)			3	9	20	145	4.53	4.58	2 <sup>nd</sup>	
Responsiveness (provision of prompt service)			2	25	5	131	4.10	4.12	4 <sup>th</sup>	
Competence(possession of requisite skill)										
Control and Negotiation Services and their Personnel			4	2	26	150	4.69	4.74	1 <sup>st</sup>	
Attitude and courtesy of personnel			3	12	17	142	4.44	4.49	4 <sup>th</sup>	
Reliability(dependable and accurate service)			2	5	25	151	4.72	4.75	2 <sup>nd</sup>	
Responsiveness (provision of prompt service)					12	20	148	4.63	3 <sup>rd</sup>	
Competence(possession of requisite skill)					7	25	153	4.80	1 <sup>st</sup>	
Extension, demolition and Alteration services and their Personnel										
Attitude and courtesy of personnel			1	8	23	150	4.69	4.74	1 <sup>st</sup>	
Reliability(dependable and accurate service)					6	9	17	139	4.34	3 <sup>rd</sup>
Responsiveness (provision of prompt service)			3	19	10	135	4.22	4.26	4 <sup>th</sup>	
Competence(possession of requisite skill)			5	9	18	141	4.41	4.47	2 <sup>nd</sup>	
Travels Arrangement Service and their Personnel										
Attitude and courtesy of personnel					14	18	146	4.56	4.59	2 <sup>nd</sup>
Reliability(dependable and accurate service)			1	19	12	136	4.30	4.38	3 <sup>rd</sup>	
Responsiveness (provision of prompt service)					24	8	136	4.30	4.27	3 <sup>rd</sup>
Competence(possession of requisite skill)					13	19	147	4.60	4.62	1 <sup>st</sup>
Catering services and their personnel										
Attitude and courtesy of personnel			4	9	19	143	4.47	4.52	2 <sup>nd</sup>	
Reliability(dependable and accurate service)					21	11	139	4.34	4.37	4 <sup>th</sup>
Responsiveness (provision of prompt service)			5	9	18	141	4.41	4.47	3 <sup>rd</sup>	
Competence(possession of requisite skill)					7	25	153	4.80	4.79	1 <sup>st</sup>

## CONCLUSION

In conclusion to this research, it was established though facility management services are outsourced but only 29.63% is outsourced. This results is justified by study carried out on outsourcing of facilities management in Nigerian hospitals by Ikediashi and Mbamali (2014) which shows that reducing invested capital funds in



non-core functions, improving on strategic positioning, obtaining technologies not available in-house, improving performance standard, improving timely delivery of service and improving on stakeholders 'satisfaction cannot be achieved maximally since the hospitals still render non-core services in house.

However, in order to improve the performance standard services rendered by the hospitals, highly competent and reliable vendors should be hired to deliver non-core Facility management services needed. Therefore Respondents in their study viewed Outsourcing as a strategic management option that has the potential to improve organisational efficiency and effective management of resources as well as increase users 'satisfaction about quality of services in hospitals. The study also provides hospital administrators and public managers with a list of prioritised factors for making rational informed decision about outsourcing of services in the hospitals.

## **RECOMMENDATIONS**

In order to add value to the management of resources in public hospitals, this study therefore recommends the following:

1. Since this project is limited to assessing the factors responsible for outsourcing of non-core facilities management services in the public hospitals within Kaduna metropolis, the Kaduna State Ministry for Health is encouraged to outsource more of the non-core services provided in-house in order to enable the state owned public hospitals focus more on their core services thereby improving their performance standard.
2. Similar studies should be conducted in federal hospitals in state in order to make it possible in making comparison between outsourced non-core FM services provided in the state owned and federal hospitals.
3. Further research could be generalized in a lesser scale to other parts of Nigeria.

## **REFERENCES**

- Abbassi, G. T., Abdel-Jabar, M. S., & Abu-Khdejeh, A. (2005), "Risk analysis for major factors affecting the construction industry in Jordan, Emirates Journal of Engineering Research, 10, 41-47
- Ancarani, A., & Capaldo, G. (2005), "Supporting decision-making process in facilitiesmanagement services procurement: A methodological approach", Journal of purchasing and supply management, 232-241.
- Ademiluyi, I. A., & Aluko-Arowolo, S. O. (2009), "Infrastructural distribution of healthcare services in Nigeria: an overview", Journal of geography and regional planning, 2(5), 104-110
- Adewunmi, Y., Omirin, M. M., & Adejumo, F. (2008), "Benchmarking in Facilities management in Nigeria", available at [www.unilag.edu.ng](http://www.unilag.edu.ng)
- Adewunmi, Y., Ajayi, C., & Ogunba, O. (2009), "Facilities management: factors influencing the role of Nigerian estate surveyors", Journal of facilities management, 7(3), 246-258
- Articles Base.( 2011). <http://www.articlesbase.com> (Accessed on 2 August 2019)

- Atkin, B. & Brooks, A. (2009), *Total Facilities Management*, 3rd edition, WileyBlackwell Publishers, New York
- Bala, A. K. (2019), *Performance Appraisal of Outsourced Pipelines Maintenance and Security Services in NNPC/PPMC Kaduna Area Operation. (Facilities Management Project)*, Department of Building, Ahmadu Bello University, Zaria.
- Barret, P., & Baldry, D. (2003), *Facilities Management: Towards Best Practices*, Blackwell Publishing, London
- Bateson, J. E. G. & Hoffman, K. D. (2011). *Service Marketing* (4th int. ed) Canada: South-Western Cengage Learning.
- Brackertz, N., & Kenley, R. (2002), "A service approach to measuring facility performance in local government", *Facilities*, 20(3/4), 127-135
- Becker, F. (1990), *The Total Workplace*, Van Nostrand Reinhold, New York, NY.
- Brown, D., & Wilson, S. (2005), *The Black Book of Outsourcing – How to manage the Changes, Challenges and Opportunities*, Wiley, Hoboken, NJ, pp.19-43
- Business Relations Management company, (2008). <http://www.brma.ru/outsourcing.html> (Accessed on 10 August 2019)
- Cigolini, R., Miragliotta, G. & Pero, M. (2011). " A road map for outsourcing facilities-related services in SMEs: Overcome criticalities and build trust. *Facilities*, 29(11), 445-458.
- Dvoracek, J., & Tyll, L. (2010). *Outsourcing a offshoring podnikatelskych cinnosti*, Praha: C. H Beck: p. 183
- Dubem Ikediashi & Ikemefuna Mbamali (2014) *Modelling the impact of outsourcing decisions on facilities management service-level performance: a case of Nigeria's public hospitals*, *Construction Management and Economics*, 32:11, 1130-1147, DOI: 10.1080/01446193.2014.961497
- Dumnaya, N. N., & Cheremisin, D. V. (2010). *Outsourcing as a new form of business organization*. [dofa.ru/Dumnaja/8\\_PBEDES/dumnaja\\_3.DOC](http://dofa.ru/Dumnaja/8_PBEDES/dumnaja_3.DOC)
- Easterby-Smith, M., Thorpe, R., & Jackson, P. R. (2008), *Management Research*, 3rd edition, SAGE Publication Limited, London
- Encyclopedia of Small Business. (2011). <http://www.referenceforbusiness.com> (Accessed on 1 August 2019)
- Flatworld Solutions Pvt. Ltd. (2011). <http://www.flatworldsolutions.com/>(Accessed on 1 September 2019)
- Encon, Y. Y. Hui & Albert, H. C. Tsang (2004) : *Sourcing strategies of facilities management* *Journal of Quality in Maintenance Engineering* Volume 10 · Number 2 · 2004 · pp. 85-92
- Ghodeswar, B. & Vaidyanathan, J. (2008), "Business process outsourcing: an approach to gain access to world-class opportunities", *Business process management journal*, 14(1), 23-38
- Hirshheim, R. A., Heinal. A., & Dibbern J. (2006) : *Information Systems Outsourcing: Enduring Themes. New Perspectives and Global Challenges*, Berlin: Springer
- Ikediashi. I (2015), "A Framework for outsourcing Facilities Management Services in Nigeria's Public Hospitals", Doctor of Philosophy Thesis Submitted to School of the Built Environment Heriot-Watt University,
- Ikediashi. (2014), "An appraisal of facilities management practice in Nigeria: A perceptual survey", *International Journal of Applied Environmental Sciences*, 7(3), 259 – 271

- International Facilities Management Association (2007), "A competency framework for facilities management".
- International association of outsourcing professionals (2011), "The global outsourcing 100", [www.iaop.org](http://www.iaop.org) [Accessed on 25/08/2019]
- Jenson, P. A. (2008), "The origin and constitution of facilities management as an integrated corporate function", *Facilities*, 26(13/14), 490-500
- Johnson, J. A. & Stoskopt, C. (2009), "Comparative Health Systems: Global Perspectives", available at <http://books.google.com.ng/books?id=9vWpcQsfeJuc&pg=PA310>. [Accessed on September 13, 2011]
- Kasper, H., Van Heldsdingen, P., Pullman., & Gabbot, M. (2006), "Services Marketing Management a Strategic Perspective, 2nd edition. Thomas South- West: Australia.
- Kremic, T., Tukel, O. I., & Rom, W. O. (2006) "Outsourcing decision support: a survey of benefits, risks and decision factors", *Supply management: An International Journal*, 11(6), 467-482.
- Kerlinger, F. N., & Lee, H. B. (2000). "Foundations of behavioral research (4th ed.) Holt, NY: Hacourt college publishers.
- Kroes, J.R. & Ghosh, S. (2010), "Outsourcing Congruence with competitive priorities: Impact on supply chain and firm performance", *Journal of operations management*, 28 (2), 124-143
- Lehtonen, T. J. T. & Salonen, A. (2005), "Procurement and relationship management trends in FM services", Paper presented at the 21st Industrial Marketing and Purchasing Conference, Rotterdam, 1-3 September
- Monczeka, R. M., Carter, J. R., Markham, W. J., Blascovich, J. D., & Slaight, T. H. (2005), *Outsourcing Strategically for Sustainable Competitive Advantage: A joint Research Study*. CAPS Research/A.T. Kearney, Inc., Tempe, AZ/Alexandria, VA
- Moschuris, S. J., & Kondylis, M. N. (2006), "Outsourcing in public hospitals, *Journal of health organisation and management*, 20(1), 4-14
- Mills, A., & Broomberg, J. (2006), "Experiences of contracting health services: an overview of literature review", *Macroeconomics, health and development series*, 33, WHO Geneva
- Nakatsu, R. T., & Iacovou, C. L. (2009), "A comparative study of important risk factors involved in offshore and domestic outsourcing of software development projects: a two-panel Delphi study", *Information and management*, 46(2009), 57-68
- Nedeeshani, W. (2006). *Procurement selection criterion for facilities management in Sri Lanka*. Unpublished dissertation, (BSc). University of Moratuwa.
- Noor, M. N. M., & Pitt, M. (2009a), "The application of supply chain management and collaborative innovation in the delivery of facilities management services", *Journal of facilities management*, 7(4), 282-297
- Noor, M. N. M., & Pitt, M. (2009b), "A critical review on innovation in facilities management service delivery", *Facilities*, 27(5/6), 211-228
- Nutt, B. (2000), "Four competing futures for facilities management", *Facilities*, 18(3/4), 124-132
- Omoruan, A. I., Bamidele, A. P., & Phillips, O. F. (2009), "Social Health Insurance and Sustainable Health care Reform in Nigeria", *Ethno-Med*, 3 (2), 105-110

- Open Systems. Online journal. (2011). <http://www.osp.ru/resources> (Accessed on 29 August 2011)
- Opaluwah, S. A. (2005), Principles and practice of facilities management in Nigeria, Still Waters Publications, Abuja-Nigeria
- Pallant, J. (2010), SPSS survival manual: a step by step guide to data analysis using SPSS for Windows, 3rd edition, Open University press, McGraw Hill, New York, NY
- Price, S., Pitt, M., Tucker, M. (2011), "Implications of a sustainability policy for facilities management organisations", *Facilities*, 29(9/10), 391 – 410
- Rainborn, C. A., Butler J. B., & Massoud, M. F. (2009), "Outsourcing support functions: Identifying and managing the good, the bad and the ugly". *Business Horizons*. 2009, Vol. 52, Iss. 4, pp. 347–356. ISSN 0007-6813.
- Rose, S., Nigel, S., & Ana I. C. (2015), "Management research: Applying the principles.
- Satanova, A., & Gejdos, P. (2010) "Ekonomika Kvality. Zvolen : TU Zvolen, p. 96
- Starner, R. (2004), "The legacy of one man", Site selection, A publication of Conway DataIncorporated, January, 2004
- Ventovuori, T. (2007), "Analysis of supply models and FM service market trends in Finland", *Journal of facilities management*, 5(1), 37-48
- Vetiva 2011, "Construction Industry Report: A haven of opportunities", A publication of Vetiva Capital Management Limited, May 2011
- Weiner, G., & Seuring, S. (2009), Performance measurement in business process outsourcing decisions. Insight from four case studies. UK: Emerald Group Publishing Limited
- World Health Organization (2007a), *World Health Statistics 2007*, Geneva: WHO.
- World Health Organization (2007b), "Health Financing and Social Protection", available at <http://www.who.int/countries> [Accessed on August 15, 2011]
- Wilson, A., Zeithaml, V., Bitner M., & Gremier, D. (2008). *Services marketing: integrating customer focus across the firm*. First European Edition.
- McGraw Hill, UK Yiu, C.Y. (2008), "A conceptual link among facilities management, strategic management and project management", *Facilities*, 26 (13/14), 510-51



# ASSESSMENT OF RESIDENTS' PERCEPTION OF INFRASTRUCTURE DELIVERY IN NIGERIA: THE TALE OF OSOGBO

Olatunji Solomon Ayodeji<sup>1</sup> and Olowoporoku Oluwaseun Ayodele<sup>2</sup>

<sup>1</sup>Department of Urban and Regional Planning, Federal University Oye- Ekiti, Nigeria

<sup>2</sup>Department of Urban and Regional Planning, Obafemi Awolowo University Ile-Ife, Nigeria

Peoples' perception of the delivery of infrastructure is important in urban planning. This is because urban planning is a public activity hence information from people who are the recipient of planning activities assist stakeholders either to reverse deteriorating conditions or enhance existing successful programs. This paper assessed residents' perception of infrastructure delivery across the identified different residential zones of Osogbo, Nigeria. This was with a view to identify the factors influencing residents' perception of infrastructure delivery in the study area. The study area was stratified into three identified residential zones (traditional, transition and sub-urban). Using systematic sampling technique a total of 390 residents were selected for survey. Findings from the study revealed that residents' socio-economic characteristics varied significantly with different residential zones. The study established that variation existed in the condition of environmental infrastructure across the study area. Also, the importance and satisfaction that residents derived from available infrastructure varied across residential differentials. Regression analysis revealed that residents' perception of infrastructure delivery are significantly influenced by age with Beta value ( $\beta = -.253$ ;  $p < .005$ ), income ( $\beta = -0.197$ ;  $p < .005$ ), length of stay ( $\beta = 0.297$ ;  $p < .005$ ), and educational status ( $\beta = 0.281$ ;  $p < .005$ ). The study concluded that residents' perception of infrastructure delivery differ significantly across the identified residential zones as reflected by residents' socio-economic characteristics. The study recommends adequate provision of infrastructure needed by each category of people in the city.

Keywords: delivery, infrastructure, Nigeria, perception, urban planning

## INTRODUCTION

All over the world, the presence and condition of environmental infrastructure has been adjudged as a key determinant of the socio-economic wellbeing of the people. This is because the economic prosperity of a nation is strongly tied to the adequate provision of infrastructural development (Olowoporoku, 2017; OECD, 2015; Fagbohunka, 2014). The World Bank (2004) noted that every 1% of government funds spent on infrastructure leads to an equivalent 1% increase in

<sup>1</sup> olatunji@fuoye.edu.ng

<sup>2</sup> oluwaseunayodele6@gmail.com

GDP in any country. Therefore, the role of infrastructure in the growth and development of any nation cannot be over emphasized. This has prompted governments in both developed and developing countries to make concerted efforts towards the provision of infrastructure that will be of benefit to the citizens (Fagbohunka, 2014). Despite the efforts, the provision of infrastructure has not met the demands of households, businesses and other users especially in the developing world and has become a major challenge to the government and other concerned stakeholders (Daramola & Olowoporoku, 2018 Obikunle, 2019).

The delivery of infrastructure is directly or indirectly essential in the determination of quality of life. According to Middleton (2011), infrastructure delivery involves the process of supplying infrastructure for residents and ensuring that they have access to the derivable benefits from its delivery. In another parlance, infrastructure delivery is the means by which facilities and services needed for the sustainability of an environment are identified and provided for (Obikunle, 2019). In Nigeria, the delivery of infrastructure is carried out majorly by the government and sometimes supported by private individuals and organizational investors. The performance of infrastructure delivery in Nigeria remains poor, unsatisfactory and has become a disease eating into the country's economic development (Daramola & Olowoporoku, 2018). Therefore in order to gain information on infrastructure delivery there must be an alignment of thoughts between the providers and the recipients of the infrastructure.

As established by Obikunle (2019) the efficiency of the delivery of infrastructural can be measured by the recipients 'level of access (availability, condition, importance and satisfaction) of infrastructure. Therefore, in order to measure the level of infrastructure delivery, opinions and perception data is needed. Perception refers to how individuals organize and interpret their impression about the environment (Olowoporoku, 2017). Peoples 'perception of infrastructure delivery provides a broad understanding of their opinion about infrastructure provided. It comprises their opinion of its availability, condition, importance and satisfaction derived from its provision. Furthermore, it is important to understand the factors that contribute to the positive or negative perception and attitudes of residents towards infrastructure because it helps to gain a deeper understanding of the residents 'attitudes and statistically measure the effectiveness of the provided infrastructure (Parks, Kearns & Atkinson, 2002).

## **LITERATURE REVIEW**

According to Kadiri, Stephen and Godwin (2015), infrastructure is defined as the aggregate of facilities which aids the effective functionality of a city. It comprises a wide range of economic and social facilities that creates an enabling environment for growth and improved quality of life (Ifediora, Ogunlola & Olubi 2014; Nubi, 2002). In a broader sense, Fulmer (2009) defined infrastructure as the physical components of interrelated systems providing services that are essential to enable, sustain and enhance the living conditions of residents. They includes power, water supply, sewerage, communication, schools, roads and bridges, airports, railways, designated green areas, housing, urban services. Infrastructure are broadly categorized into two namely social and economic (Obikunle, 2019; OECD 2015; UN-Habitat, 2015; Fagbohunka, 2014; Palei 2014; Torrissi, 2010). Economic

infrastructure refers to facilities, activities and services provided to facilitate production and consumption. On the other hand, social infrastructures are facilities that support social services with indirect impact on the welfare of the people (Daramola & Olowoporoku, 2018; Torrisi, 2010). Nevertheless, the delivery of infrastructure has been a source of concern in Nigeria

Issues related to infrastructure have aroused the interest of researchers both in the developed and developing world. In the developed world, emphasis has shifted towards maintenance of infrastructure that have been put in place (Srinivaso, 2013; Fulmer, 2009; Torrance, 2009) while the developing world is battling with the adequate provisions of infrastructure (Fagbohunka, 2014). Studies that have examined infrastructural development in Nigeria (Obikunle, 2019; Fagbohunka, 2014; Ibrahim, 2010; Oyedele, 2006; Abdulkareem & Adeoti, 2004) focused on the economic potentials of provision and maintenance of infrastructure. These past studies did not extensively discuss public perception of the delivery of available infrastructure and this study is a conscious attempt to bridge this gap. Information on residents' perception of infrastructure delivery are central to policy making as they aid policy makers in making enlightened decisions towards provision of infrastructure in the study area and others with similar background.

### **Materials and Methods**

The study area is Osogbo, the capital of Osun State, located in south-western part of Nigeria. It was founded in the late 18th century and originated as a traditional as well as cultural city. Following the creation of Osun State in 1991, Osogbo assumed the status of a state capital. Over the years, Osogbo has witnessed tremendous growth both spatially and demographically. Its nature as a nodal settlement and the initial establishment of a railway station are factors in the growth of Osogbo. The National Bureau of Statistics (NBS) (2007) reported the population of Osogbo in the 2006 population census to be 287,156 persons. The World Population review (2021) projected the population of the city as 720, 539 persons.

The city is mainly covered by two Local Government Areas (LGAs) which are Osogbo and Olorunda. The two LGAs in the city contain 26 political wards as delineated for election purposes. A typical characteristic of traditional African cities is the presence of homogeneous residential zones. Three homogeneous residential zones are identified in Osogbo: the core, the transition and the sub-urban. These identified zones are arranged in radial pattern following the concentric zone theory of Ernest Burgess of 1920s. Each of these zones is observed to be internally homogeneous in terms of physical characteristics, socio-economic status and availability of environmental amenities.

The core residential area, is the centre of the city. It is the home to indigenes and first migrant settlers. It accommodates the king palace, traditional markets, shrines, market square and the town hall. Residential buildings in this zone are closely built together and connected to one another with foot paths in a serpentine manner. It is characterized by aged buildings, built mainly of traditional system and old building materials. Residents in this zone are of low income status and low educational qualification. The zone is usually devoid of adequate environmental amenities.

The transition zone evolved during the colonial rule. It is the intermediate zone after the core residential area. The zone is characterized with improved road accessibility and better provision of environmental amenities. Heterogeneity of ethnic composition of residents is introduced in this zone. The sub-urban residential zone is characterized with well laid out plans. The ethnic composition is more heterogeneous and the residents mostly engage in white collar jobs. The building types comprised mainly flats and duplexes with small private open spaces. Also, the zone is of better provision environmental amenities compared with the other two zones. Nevertheless population density in the zone is smaller when compared with the other two zones.

## **METHODOLOGY**

The 26 political wards in the city of Osogbo were stratified into the identified residential zones. This comprised seven wards in the core area, ten wards in the transition zone and nine wards in the sub-urban zone. Due to the homogeneity of the residential zones, one ward was selected in each of the three residential zones. In the three selected wards, every 10th residential building was sampled sequel to enumeration of buildings based on street numbering system and counting of buildings where houses were not numbered, especially in the core area. In each selected buildings, the focus was on any adult from age 18 years and above. The benchmark of 18years is premised on the appointed age of legal transition into adulthood in the country. A total of 390 residents were selected from the 390 selected buildings on which questionnaires were administered. The sample comprised 135 respondents in the core area, 147 respondents in transition area and 108 respondents in the sub-urban area.

Primary data were collected through the administration of the questionnaire on household heads in the area during the site observation and survey by the research team. The questionnaire addressed the socioeconomic characteristics of residents as well as the condition, importance and satisfaction residents derived from the available infrastructure in the study area. Analysis of the data was done using cross tabulation, Analysis of Variance (ANOVA) and Regression Analysis. Data on the condition of infrastructure were obtained using a 5-point Likert scale. Residents were to express their opinions using: scales of 'Very Good '(5), 'Good '(4), 'Fair '(3), 'Poor (2) 'and 'Very Poor (1)'. The respondents were likewise asked to rate the importance they attached using the scales of Very Important '(5), 'Important '(4), 'Just Important '(3), 'Not Important '(2) 'and 'Not Important at all '(1). The opinions of respondents based on the satisfaction they derived from available infrastructure was measured using the scale: 'Very Dissatisfied '(5), 'Slightly Dissatisfied '(4), 'Just Satisfied '(3), 'Moderately Satisfied '(2) 'and 'Very Satisfied '(1)'. These mean indexes were interpreted in the analysis as: 1-2.4 (low), 2.5 - 3.5 (moderate) and 3.6 - 5.0 (high).

The mean index was used to analyze the condition of infrastructure, importance attached to infrastructure and the satisfaction residents derived from the available infrastructure with the results "Infrastructure Condition Indexes" (ICIs), "Importance Attached to Infrastructure Indexes "and "Satisfaction Derived from Infrastructure" (SDRIs) were evolved from the analysis of the responses. The summation of weight value (SWV) for each item was obtained through the sum of the product of the



number of responses to each item and the respective weighted value attached to each rating. This is expressed mathematically as:

$$SWV = \sum_{i=1}^5 X_i Y_i$$

Where:

SWV = summation of weight value,

$X_i$  = number of respondents to rating  $i$ ;

$Y_i$  = the weight assigned a value ( $i = 1, 2, 3, 4, 5$ ).

The ICI for each item on the scale was arrived at by dividing the SWV by the total number of respondents ( $N=390$ ), mathematically expressed as:

$$ICI = \frac{SWV}{N}$$

The ICI later was computed by summing the rating on the condition of infrastructure and dividing by the number of the number of infrastructure ( $n$ ), mathematically expressed as:

$$ICI = \frac{ICI}{n}$$

The infrastructure with the actual values of the ICI indicated a fair level of the condition of the infrastructure. Values with positive deviations indicated good condition of infrastructure, while those with negative deviations indicated poor condition of infrastructure. The ranks of the index values were likewise provided.

The deviations around the mean for each Infrastructure Condition Index was also computed. The deviations were representative measures of dispersion that provided information on the condition of infrastructure as perceived by the residents. The variables with positive deviations implied good condition of infrastructure, while those with negative deviations indicated low poor condition of infrastructure. The same procedure that was used in computing the Importance Attached to Infrastructure Indexes and Satisfaction Derived from Infrastructure. Examples of similar uses are found in studies by Olowoporoku et al (2020), Afon (2011), Afon, Abolade, and Okanlawon (2006).

## RESEARCH FINDINGS

This section discusses the profile of the respondents. It also contains discussions on the availability, condition, importance and satisfaction residents derive from the available infrastructure in the study area.

### Socio-economic attributes of residents

Socioeconomic attributes of people have been established to be a crucial factor in the assessment of people's opinion on various environmental concerns (Lindell, 2013; Twig & Mose, 2017; Olowoporoku, Daramola & Odunsi, 2021; Olawuni, Daramola & Odunsi, 2021). In this study, variables discussed in this regard are gender, age, income, educational status, length of residence and household size.

**Table 1: Socioeconomic attributes of respondents**

Attribute	Core	Transition	Sub-urban	Total
	Frequency (%)	Frequency (%)	Frequency (%)	Frequency (%)
Male	69 (51.1)	48 (32.7)	27 (25.0)	144 (36.9)
Female	66 (48.9)	99 (63.3)	81 (75.0)	246 (63.1)
Total	135 (100.0)	147 (100.0)	108 (100.0)	390 (100.0)
Age				
Less than 20	39 (28.9)	27 (18.4)	15 (13.9)	81 (20.7)
20-40	87 (64.4)	87 (59.2)	69 (63.9)	243 (62.3)
41-60	9 (6.7)	18 (12.2)	18 (16.6)	45 (11.5)
≥60	0 (0.0)	15 (10.2)	6 (5.6)	21 (5.4)
Total	135 (100.0)	147 (100.0)	108 (100.0)	390 (100.0)
Educational Status				
No Formal Education	31(22.9)	9 (6.1)	3 (2.8)	43 (11.0)
Primary	39 (28.9)	42 (28.6)	24 (22.2)	105 (26.9)
Secondary	54 (40.0)	66 (44.9)	18 (16.7)	138 (35.4)
Tertiary	11 (8.1)	30 (20.4)	63 (58.3)	104 (26.7)
Total	135 (100.0)	147 (100.0)	108 (100.0)	390 (100.0)
Income Status				
≤N30,000	120 (88.9)	63 (42.9)	42 (38.9)	225 (57.7)
N31,000- N90,000	12 (8.9)	75 (51.0)	45 (41.7)	132 (33.4)
≥N91,000	3 (2.2)	9 (6.1)	21 (19.4)	33 (8.7)
Total	135 (100.0)	147 (100.0)	108 (100.0)	390 (100.0)
Household Size				
1 – 5	18 (13.3)	35 (23.8)	57 (52.7)	110 (28.2)
6 – 10	45 (33.3)	70(47.6)	45 (41.7)	160 (41.0)
Above 10	72 (53.4)	42 (28.6)	6 (5.6)	120 (30.8)
Total	135 (100.0)	147 (100.0)	108 (100.0)	390 (100.0)
Length of Residence				
≤10years	45 (33.3)	33 (22.5)	24 (22.2)	102 (26.1)
11 – 20years	31 (23.0)	61 (41.5)	67 (62.0)	159 (40.8)
≥21 years	59 (43.7)	53 (36.0)	17 (15.8)	129 (33.1)
Total	135 (100.0)	147 (100.0)	108 (100.0)	390 (100.0)

As presented in Table 1, findings revealed that 36.9% of the respondents were males while majority (63.1%) were females. The continuous raw data collected on age of the residents were categorized into four to aid better presentation. Findings revealed that 20.7% of the respondents were less than 20 years of age, 62.3% respondents had age range of 20 – 40 years, 11.5% were within the age bracket of 41 – 60 years while the remaining 5.4% were above 60 years of age. Further findings revealed that the overall mean age was 39 years while the minimum and maximum ages were 19 years and 73 years respectively. The findings revealed that respondents were of age and could provide information on the delivery of infrastructure in the study area.

According to Daramola (2015) and Olowoporoku et al (2019), level of education of people is an important tool in the assessment of their opinion on any environmental matter. Findings on educational attainment of respondents in the

study area revealed that in the core area, 8.1% of the respondents had tertiary education. This increased in the transition and suburban zones to 20.4% and 58.3% respectively. On secondary education, 40.0% of the residents in the core area attained secondary education, in the transition it was 44.9% and 16.7% in the sub-urban zone. Residents with primary education comprised 28.9%, 28.6% and 22.2% in the core, transition and suburban areas of the study area. On the other hand, the proportion of respondents with no formal education comprised 22.9% in the core, 6.1% in the transition area and 2.8% in the suburban area. The proportion of respondents with no formal education decrease as distance increases from the core area to the sub-urban area while the proportion of residents with tertiary education decreases as distance reduces from the suburban to the core. These results are similar to earlier studies by Daramola and Olowoporoku, (2019), Daramola (2015) that increased educational level in traditional African cities varied directly with increase in distance from the core towards the sub-urban residential area. Since majority of the respondents attained a level of education, it is believed that they will have information on the availability, condition and satisfaction they derived from infrastructure in the study area.

Findings were made on the average monthly income of residents across the identified residential zones. For easy analysis, the initial quantitative data on residents 'average monthly income were grouped into three: low, medium and high. Incomes below ₦30,000 were categorized as low income. This is based on the prevailing Civil Service Salary Scale in the country. The minimum wage at the federal level in Nigeria is ₦30,000 while it ranges from ₦20,000 to ₦30,000 in the states of the federation. The medium monthly incomes were categorized as from ₦31,000 to ₦90,000 while residents earning above ₦90,000 were categorized as high income earners. Based on this categorization, findings revealed that variation in income classes existed across the three residential zones of the city. Further investigation revealed that the average monthly income computed for the core, transition and sub-urban stood at ₦21,330.00, ₦43,455.00 and ₦76,180.00 respectively while the overall mean monthly income was ₦43,203.00. These results revealed that income distribution varied significantly with residential areas and it increased with increase in distance from the core to the sub-urban. The ANOVA results ( $F= 7.139$ ;  $p < 0.002$ ) indicated that income distribution of the residents varied significantly with residential zones. The findings are in tandem with the studies carried out in other traditional African cities such as Ogbomoso (Afon, 2006) and Ibadan (Afron and Faniran, 2013; Daramola, 2015) where conclusions were made that residents 'income increased as distance increased from the core to the suburban areas of African traditional cities.

Investigations were made into household size of residents in the study area. A household was defined as a person or group of people with shared cooking and living arrangements. Thus, household size was measured by the number of people living together with common eating arrangement. Based on this, the household size of the residents was categorised into three. The household sizes of one to five members were categorised as small, those with six to ten members as medium while those with more than ten members was categorised as large. Findings revealed that, across the residential zones, 28.2% had small household size, 41.0% had medium household size while 30.8% had large household size. The calculated household size of respondents in the core, transition and sub-urban area were

eight persons, six persons and five persons respectively. The ANOVA results ( $F=9.106$ ;  $p < 0.001$ ) also indicated that household size varied significantly with residential zones. Information on household size could provide information on adequacy of infrastructure in the study area.

Length of residence refers to the number of year(s) a household has been in the study area and it is considered relevant to this study. This is because the longer the period people live in an area; the more they are likely to understand the prevailing challenges in an area (Olaniyi, 2018; Daramola & Olowoporoku, 2016). For this study, the length of residence is divided into three categories of 1 to 10 years, 11 to 20 years and above 20 years. Findings revealed that 26.1% of the respondents had spent less than 10 years in their residential areas; 40.8% had spent 11 to 20 years while 33.1% of the residents had lived for more than 20 years in their residential areas. Further findings revealed the mean length of residence in the core was 31 years 19 years in the transition and 13 years in the sub-urban areas. From this analysis, it could be deduced that the residents have lived in the area for a considerable number of years and would be familiar with the environment and thus can provide adequate information on the delivery of infrastructure in the study area.

### Condition of infrastructure

Presented in this section are findings on the condition of infrastructure available across the identified residential zones in the study area. The condition of infrastructure was measured using the Infrastructure Condition Index (ICI). Also the deviation about the mean (DM) for each infrastructure was calculated.

**Table 2. Infrastructure condition index**

Infrastructure	Residential zone					
	Core		Transition		Suburban	
	ICI	DM	ICI	DM	ICI	DM
Road Network	2.703	-0.188	3.366	0.536	2.237	-0.270
Public Tap	2.687	-0.204	1.268	-1.561	1.229	-1.278
Waste Collector Trucks	2.289	-0.602	2.947	0.117	3.171	0.664
Communication	2.289	-0.602	2.810	-0.019	2.135	-0.372
Electricity Supply	3.158	0.266	2.780	-0.049	3.132	0.625
Hospitals	3.522	0.630	3.211	0.381	1.818	-0.689
Public Schools	3.976	1.084	2.898	0.068	1.805	-0.702
Private Schools	3.151	0.259	3.176	0.346	3.989	1.482
Police station	2.932	0.040	3.658	0.828	3.738	1.231
Open spaces	1.909	-0.982	3.477	0.647	3.674	1.167
Drainage	2.424	-0.467	2.295	-0.534	1.659	-0.848
Railway	1.307	-1.584	1.982	-0.847	1.61	-0.897
Sewerage collection	4.01	1.118	2.366	-0.463	2.237	-0.270
Market	4.703	1.811	3.268	0.438	2.229	-0.278
Waste Disposal sites	2.317	-0.574	2.947	0.117	2.947	0.440
<b>ICI</b>	2.891		2.829		2.507	

\* ICI\*= Infrastructure Condition Index \*DM\*= Deviation about the Mean

As contained in Table 2, the condition of infrastructure revealed that the computed mean Incident Condition Indexes ((ICI)<sup>LT</sup>) in the core, transition, and suburban residential areas were 2.891, 2.829 and 2.507 respectively. Impliedly, the condition of infrastructure in the core was higher compared to the transition area and least in the suburban area. Infrastructure whose conditions were rated highest in the core area were markets (4.703), sewage collection (4.01), public schools (3.976), hospitals (3.522) and private school (3.151). In the transition zone, police station (3.658), open space (3.477), road network (3.366), market (3.268) and hospitals (3.211). In the suburban area, private school (3.989), police station (3.738), open spaces (3.674), waste collector trucks (3.171) and hospital (3.132). In summary, residents in the study area rated the condition of available infrastructure low. Infrastructures in low conditions are usually over stretched, damaged and cannot meet the demand of the consumers (residents).

**Importance attached to infrastructure**

Sequel to findings on the condition of infrastructure, investigation was made into the importance residents attached to available infrastructure in the study area. The level of importance that residents attach to infrastructure in the study area serves as an indicator to determine the value that residents attach to each infrastructure. Residents' expression of the necessity of each infrastructure is presented in Table 3.

**Table 3. Importance Attached to Infrastructure Index (IAII)**

Infrastructure	Residential zone					
	Core		Transition		Suburban	
	IAII	DM	IAII	DM	IAII	DM
Road Network	4.754	0.276	4.689	0.370	4.851	0.400
Public Tap	4.750	0.272	4.644	0.325	4.136	-0.315
Waste Collector Trucks	4.667	0.189	4.462	0.143	4.543	0.092
Power Supply Cables	4.529	0.051	4.333	0.014	4.521	0.070
Communication	4.508	0.030	4.689	0.370	4.778	0.327
Hospitals	4.492	0.014	4.381	0.062	4.438	-0.013
Public Schools	4.497	0.019	4.415	0.096	4.435	-0.016
Private Schools	4.471	-0.007	4.244	-0.075	4.778	0.327
Police station	4.457	-0.021	3.902	-0.417	4.053	-0.398
Open spaces	4.452	-0.026	3.902	-0.417	4.000	-0.451
Drainage	3.897	-0.581	3.194	-1.125	3.814	-0.637
Railway	3.754	-0.724	4.415	0.096	4.851	0.400
Sewerage collection	4.750	0.272	4.644	0.325	4.500	0.049
Market	4.667	0.189	4.462	0.143	4.543	0.092
Waste Disposal sites	4.529	0.051	4.415	0.096	4.521	0.070
<b>IAII</b>	4.478		4.319		4.458	

\* IAII\*= Importance Attached to Infrastructure Index \*DM\*= Deviation about the Mean

Findings revealed that the importance respondents attached to infrastructure was higher in the core area, compared to the suburban area and compared to the transition area. This findings is in tandem with (Olaniyi, 2018; Daramola, Olowoporoku & Popoola 2017; Daramola, 2015; Afon & Faniran, 2011) which

stated residents in the core area attach more importance to infrastructure because majority of respondents are of the low income class and rely on public infrastructure for survival. In the core area, infrastructure that respondents attached most importance to were road network (4.75), public tap water (4.750), sewerage collection (4.750), waste collection trucks (4.667), market (4.667) and communication (4.539). In the transition area, road network (4.689), electricity supply (4.689), sewerage collection (4.644), markets (4.462), waste collection trucks (4.462) and public schools (4.215) were the infrastructure that residents attached high importance to while in the sub-urban area, road network (4.851), railway (4.851), electricity supply (4.778), private schools (4.778), waste collector trucks (4.543), markets (4.543) and communication (4.521) were the infrastructure that weighted highest in terms of importance attached to it by respondents. In summary, across the three residential areas, markets, waste collection trucks and electricity supply were the infrastructure that weighted highest in the three residential areas.

### Satisfaction respondents derived from available infrastructure

Information on the satisfaction residents derived from the infrastructure will provide answers on the pleasure residents' derived from the infrastructure.

**Table 4. Satisfaction Residents' Derived from Infrastructure Index (SRDI)**

Infrastructure	Residential zone					
	Core		Transition		Suburban	
	SRDI	DM	SRDI	DM	SRDI	DM
Road Network	3.044	0.478	3.794	1.110	3.886	1.284
Public Tap	2.930	0.364	1.652	-1.032	1.829	-0.773
Waste Collector Trucks	2.889	0.323	2.646	-0.038	3.794	1.192
Communication	2.800	0.234	1.622	-1.062	2.788	0.186
Electricity Supply	2.767	0.201	3.533	0.849	3.722	1.120
Hospitals	1.767	-0.799	3.500	0.816	3.629	1.027
Public Schools	1.756	-0.810	1.438	-1.246	1.500	-1.102
Private Schools	1.707	-0.859	3.367	0.683	2.469	-0.133
Police station	3.548	0.982	2.114	-0.570	2.424	-0.178
Open spaces	2.366	-0.200	2.408	-0.276	2.382	-0.220
Drainage	2.256	-0.310	2.167	-0.517	1.310	-1.292
Railway	1.044	-1.522	1.094	-1.590	1.886	-0.716
Sewerage collection	2.930	0.364	3.652	0.968	2.829	0.227
Market	3.889	1.323	3.646	0.962	2.794	0.192
Waste Disposal sites	2.800	0.234	3.622	0.938	1.788	-0.814
<b>SRDI</b>	2.566		2.683		2.602	

\* SRDI\* = Satisfaction Residents' Derived from Infrastructure Index \*DM\* = Deviation about the Mean

The computed mean Satisfaction Residents' Derived from Infrastructure Index were 2.566, 2.638 and 2.602 respectively. From the computed  $((SRDI) - \bar{X})$ , it is implied that the satisfaction residents derived from available infrastructure was more in the core compared with the suburban and compared with the transition area. In the core residential area, infrastructure that residents derived highest satisfaction from their delivery were markets (3.889), police station (3.548), road network (3.044), public

tap (2.930) and sewerage collection (2.930). On the other hand, railway, private school, public school and hospitals were the least weighted infrastructure in terms of satisfaction derived from them by residents in the residential zone. In the transition area, road network (3.794), sewerage collection (3.652), market (3.646), waste disposal sites (3.622), electricity supply (3.533) and hospital (3.50) were the highest rated infrastructure that residents derived satisfaction from their provision. Those that were least rated in terms of satisfaction derived in the transition area were railway, public schools, communication and public taps. In the suburban area, road network (3.866), waste collection trucks (3.794), electricity supply (3.722), hospitals (3.629) and sewerage collection (2.829) were the highest rated in terms of infrastructure while the least rated in the residential zone were drainages, public schools, waste disposal sites, public tap etc. In summary, it was revealed that satisfaction residents derived from the available infrastructure is very low.

**Table 5: Residents’ perception of the delivery of infrastructure regressed on socioeconomic characteristics**

Model	Unstandardized Coefficients		Standardized Coefficients	t	Sig.
	B	Std. Error	Beta		
(Constant)	41.832	2.346		9.425	.000
Gender	.136	.108	.090	1.527	.097
Age	-.235	.005	-.127	-3.023	.005
Monthly income	-.197	.007	.203	6.548	.003
Number of years spent in the area	.297	.006	-.019	-.326	.004
Household size	-.033	.012	-.084	-1.289	.166
Educational status	.281	.057	.247	4.337	.005

Dependent variable: Residents’ Experience of Urban Legibility; R = 0.356; R Square = 0.186 p ≤ 0.05

Presented in Table 5 are results of the combined effects and the relative contributions of each independent variable on residents’ perception of the delivery of infrastructure. The composite correlation coefficient of the relationship between socioeconomic characteristics and residents’ perception of the delivery of infrastructure is 0.356. This value provides a good estimate of the overall fit of the regression model. The regression value (R<sup>2</sup>) which provides a good gauge of the substantive size of the relationship is 0.186 for this model. This implies that 18.6% of the variance in residents’ perception of the delivery of infrastructure is accounted for by the predictor variables. Also presented in the table is the relative contribution of each predictor variable to the variance in residents’ perception of the delivery of infrastructure in the study area. Variables that influenced residents’ perception of infrastructure delivery are significantly influenced by age with Beta value ( $\beta = -.253$ ;  $p < .005$ ), income ( $\beta = -.197$ ;  $p < .005$ ), length of stay ( $\beta = 0.297$ ;  $p < .005$ ), and educational status ( $\beta = 0.281$ ;  $p < .005$ ). Other socioeconomic attributes such as gender and household size predictor variables have no significant effect on residents’ perception of the delivery of infrastructure in the study area. Therefore it can be concluded that a statistically significant relationship exists between residents’ perception of the delivery of infrastructure in the study area and socioeconomic attributes such as age, income, length of stay and

educational status in the study area. Thus, these variables serve as predictors of residents' perception of the delivery of infrastructure in the study area.

## **CONCLUSION**

This study assessed residents' perception of infrastructure delivery across the identified residential areas in Osogbo, Nigeria. It also identified the factors influencing residents' perception of infrastructure delivery in the study area. Specifically, the findings established that there were variations in the condition of infrastructure, importance residents attached to infrastructure and satisfaction derived from the provision of infrastructure across the residential zones of the city. These variations could be attributed to variation in socio-economic characteristics of residents across the residential areas of the city. The residents in the suburban area were satisfied with infrastructure delivery, this is because, and these residents are high income earners that can easily afford to provide some of the facilities privately. Based on the findings from the study, it is concluded that socio-economic characteristics such as age, income, length of stay and educational status significantly influenced residents' perception of the delivery of infrastructure.

Based on these, the following are recommended to improve the delivery of infrastructure in Osogbo:

- government and other concerned stakeholders must invest in adequate provision of infrastructure in the study area. This can be achieved through the introduction of Public Private Partnership into infrastructure provision in the study area;
- government and other concerned stakeholders should ensure adequate maintenance and upgrade of existing infrastructure. Proper maintenance of infrastructure will help to improve the physical and economic life of the infrastructure. When infrastructure is maintained, residents get to enjoy its benefits and the institution (which most residents think should be the government) will save significant cost.
- infrastructure delivery, maintenance and monitoring needs planning and execution, one is not more important than the other, planning will include financial planning and budgetary, data gathering and analysis on the appropriate infrastructure to be provided and future control of infrastructure maintenance
- residents should be made to pay for the use of infrastructure in the study area in order to make them sustainable.

## **REFERENCES**

- Abdulkareem, Y., & Adeoti, K. (2004). Road Maintenance and National Development. National Engineering Conference, Kwara State, Nigeria.
- Afon, A. O. (2006). The Use of Residents' Satisfaction Index in Selective Rehabilitation of Urban Core Residential Areas in Developing Countries. *International Review for Environmental Strategies* 6(1): 137–152.



- Afon, A. O., Abolade, O., & Okanlawon, S. A. (2006). Users 'perception of environmental hazards and risks as a tool in public space management: the case of selected motor parks in Lagos, Nigeria. A paper presented at the 5th Fig Regional Conference on promoting land administration and good governance, Accra, Ghana, March 8-14
- Afon, A. O., & Faniran, G. B. (2013). Intra- Urban Citizen Participation in Monthly Environmental Sanitation in Nigeria; The Ibadan Experience. *Journal of applied Sciences in Environmental Sanitation* 8(1): 1-10.
- Daramola, O. P. (2015). Environmental Sanitation Practices in Residential Areas of Ibadan Metropolis. A Thesis Submitted in Partial Fulfillment of the Requirement for the Award of Doctor of Philosophy Degree in the Department of Urban and Regional Planning, Faculty of Environmental Design and Management, Obafemi Awolowo University, Ile-Ife, Nigeria
- Daramola, O., & Olowoporoku, O. (2016). Environmental Sanitation Practices in Osogbo, Nigeria: An Assessment of Residents 'Sprucing Up of Their Living Environment. *Journal of Economic and Environmental Studies*. Faculty of Economics, University of Opole, Opole, Poland, 16 (4): 699-716. <http://hdl.handle.net/10419/178943>
- Daramola, O., & Olowoporoku, O. (2017). Plurality of Urban Governance in Nigeria and its Implications on Delivery of Environmental Services. *Advances in Environmental Research*. 6(1): 25-33. <https://doi.org/10.12989/aer.2017.6.1.025>
- Daramola, O., & Olowoporoku, O. (2019). Exploring Residents 'Perception of the Conduct of Environmental Sanitation Exercise in Osogbo, Nigeria. *Journal of Environmental Design and Management* 9 (2):118-126
- Fagbohunka (2014). The Pertinence of Infrastructural Facilities in Rejuvenation of Small Scale Enterprises in Ikare-Akoko, Ondo State. *Economic and Environmental Studies*.
- Fulmer, J. (2009). What in the World is Infrastructure? Investment Strategy: Infrastructure Investment Guest Article
- Ibrahim (2010). "Problems Associated with Management of Public Infrastructures in Nigeria" *Environmental Watch III*, pp 20-27.
- Ifediora, Ogunlola, & Olubi (2014). Panacea for Sustainable Infrastructural Development in Nigeria.
- Kadiri, Stephen, & Godwin (2015). Implications of Adopting Public Private Partnership for Infrastructure Development in Nigeria. *Journal of Sustainable Development*.
- Lindell, M. K. (2013). North American cities at risk: Household responses to environmental hazards. In *Cities at risk: Living with perils in the 21st century*, ed. H. Joffe, T. Rossetto, and J. Adams, 109–130. Dordrecht: Springer.
- Nubi, T. O (2002). Procuring, Managing and Financing Urban Infrastructure: Towards Integrated Approach. A paper presented at a National Workshop on Land Management and Property Tax Reform in Nigeria.
- Obijunle, W. A. (2020). Residents 'Perception of Infrastructure Delivery in Osogbo, Nigeria. A BSc Thesis submitted to the Department of Urban and Regional Planning, Obafemi Awolowo University, Ile-Ife, Nigeria
- OECD (2015). Towards a Framework for the Governance of Infrastructure. Public Governance and Territorial Development Directorate Public Governance Committee.
- Olowoporoku, O. A. (2017). Residents 'Perception of Environmental Hazards and Risks in Coastal Towns of Delta State, Nigeria. An M.Sc. Thesis submitted to the Department of Urban and Regional Planning, Obafemi Awolowo University, Ile-Ife, Nigeria.

- Olowoporoku, O. A., Daramola, O. P., Olaniyi, K., Odeyemi, G., & Mobolaji, D. (2019). Urban Legibility Condition in Nigeria: A Narration of Residents' Experience in Ibadan Metropolitan Area. *Journal of Economics and Environmental Studies*. Faculty of Economics, University of Opole, Opole, Poland 19 (4):315-338. <https://doi.org/10.25167/ees.2019.52.2>
- Olowoporoku, O. A., Daramola, O. P., Olaniyi, K., & Odeyemi, G. (2020). Navigating the Urban Space: Assessment of Residents' Experience and Satisfaction with the Legibility of Ibadan Municipality, Nigeria. *Journal of Environmental Quality*, 1-13. <http://dx.doi.org/10.1002/tqem.21710>
- Olowoporoku, O. A., Daramola, O. P., & Odunsi, O. M. (2021). Determinants of Residents' Perceived Environmental Hazards and Risks in Coastal Towns of Delta State, Nigeria. Elsevier Publisher. *International Journal of Disaster Risk Reduction* <https://doi.org/10.1016/j.ijdr.2021.102094>
- Olawuni, P. O., Olowoporoku, O. A., & Daramola, O. P. (2021). Determinant of Residents' Participation in Disaster Risk Management in Lagos Nigeria *International Journal of Disaster Risk Management* 2 (2). 1-18 <https://doi.org/10.18485/ijdrm.2020.2.2.1>
- Oyedele, O. (2012). The Challenges of Infrastructure Development in Democratic Governance.
- Parks, Kearns & Atkinson (2002). Factors that Influence Residents Satisfaction with Neighbourhoods" *Environmental Behaviour* DOI 10.1177/0013916507307483
- Palei, T. (2014) Assessing the Impact of Infrastructure on Economic Growth. *Global Competitiveness- 2nd Global Conference on Business Economics, Management and Tourism*, Prague.
- Srinivasa (2013). Infrastructure Development and Economic Growth: Prospects and Perspective.
- Torrise, G. (2009). Public Infrastructure: Definition, Classification and Measurement Issues. Association of Sustainable Education, Research and Science.
- Torrise, G. (2010). Infrastructures and Economic Performance: A Critical Comparison Across Four Approaches, Theoretical and Practical Research in Economic Fields. Association for Sustainable Education, Research and Science, 1.
- Torrance (2009). The Rise of a Global Infrastructure Market Through Relational Investing. *Economic Geography*, 85.
- Twigg, J., & Mose, I. (2017). Emergent groups and spontaneous volunteers in urban disaster response. *Environment & Urbanization International Institute for Environment and Development* 29 (2): 443-458. DOI: 10.1177/0956247817721413
- United Nations HABITAT (2015). Transforming our World: The 2030 Agenda for Sustainable Development Standard for an Infrastructure Delivery Management System Draft.
- WHO (2004). Water for Life: "Making it Happen" World Health Organization Geneva, Switzerland.
- World Population Review (2021). Population of Cities in Nigeria. <http://worldpopulationreview.com/countries/nigeria-population/cities/>



---

# ASSESSMENT OF SEASONAL FLOOD IMPACT AND MANAGEMENT STRATEGIES IN OKITIPUPA, ONDO STATE, NIGERIA

Olorunlana, Folasade Aderonke<sup>1</sup>

*Department of Geography and Planning Sciences, Adekunle Ajasin University, Akungba-Akoko, Ondo State, Nigeria*

Flood is becoming the most environmental challenge menacing Okitipupa in Ondo State. Many parts of the metropolis experience flood regularly most especially during and after rains. This study assesses how Okitipupa have been affected by flood menace incidences as it takes a look at the devastating impacts, remedial and management strategies at curbing flooding in Okitipupa which has almost become a yearly occurrence. Data were collected through the use of structured questionnaire from the respondents. A total of two hundred (200) questionnaires were administered to the respondents in the study area. The questionnaires were distributed using the systematic random technique at interval of ten housing units. Data collected were analyzed through the use of descriptive statistical analysis and presented using pie chart. The study reveals that the major cause of flood in the study area was high intensity of rainfall (21.5%) followed by dumping of waste materials and refuse into drainage (21%). Also, blockage of natural and artificial waterways (18.5%) and building on floodplain (16.5%) have contributed to the regular occurrence of flood in the area. Poor drainage system (14%) and improper planning and poor land use (8.5%) also contributed to flood in the area. Flood remedial and management strategies adopted by respondents include proper use of drainage system, proper refuse disposal, construction of drainage where there is none, proper land use planning, use of sandbags and river channelization. The study recommends enforcement of environmental laws that will restrict dumping of waste into the water body and sponsoring of public awareness and educative programs on how man's activities has contributed to flood occurrence.

Keywords: causes, floods, impacts, remedial and management strategies

## INTRODUCTION

Flood is a body of water which overflow swathes of land not normally inundated (Duru et al., 2014). Flooding, according to Geo-science Australia (2013) can simply be described as "water where it is not wanted". It can also be conceptualized as a situation that results when a part of the earth surface that is usually dry is inundated and covered with water due to high amount of rainfall or the over flowing of a water body. Documental evidence showed that it all started with the Noachian deluge when the surface of the earth was submerged by water orchestrated by

---

<sup>1</sup> Tise80097@yahoo.com

unabated torrential rainfall which led to the extermination of mankind with the sole exclusion of Noah's household (Olatona et al., 2017). The forgoing narrative thus suggest the necessity on the part of man to mitigate the effects of flooding in his environment by ensuring that all vulnerable landscape is identified and precautionary measures are put in place to tackle the impending challenge headlong.

The effects of floods are always debilitating, though their intensity and scope vary depending on terrain, intensity of human activities, quantum of water and the level of preparedness by the stakeholders. Flooding is a global phenomenon ravaging both the developed and developing nations with its deleterious effects sparking serious attention; which has become subject of research interest among climatologist, hydrologist, economist, urban planner and other professionals in the built environment. This is not unconnected to the fact that it is the most common and destructive of all natural hazards with wide reaching effects, wrecking havocs to the built and natural environments, as well as, endangering human health and material possessions (Saleh, 2014).

The complexity of anthropogenic activities of man without adequate attention to geological structure of most cities of developed and developing nations has undoubtedly contributed to reoccurrence of disaster and consequently poses threat to environmental sustainability in most of these nations (Oludare et al., 2012). This irrefutably has led or accumulated to unresolved challenges. Among the unresolved challenges being faced are vicious flood incidences experienced in the last four decades. The occurrence is stern in third world countries where there is intensity in land use, haphazard development, and unprecedented urbanization among others. Consequently, there has been unprecedented occurrence of floods and its associated negativities in most of the urban centers of developing countries (Montoya Morales, 2002). For instance, in Nigeria, reports have shown that devastating flood disaster had occurred in Ibadan (1985, 1987, 1990, and 2011), Osogbo (1992, 1996, 2002, and 2010), Yobe (2000), Akure (1996, 2000, 2002, 2004 and 2006) and the coastal cities of Lagos, Ogun, Port Harcourt, Calabar, Uyo, Warri among others (Olaniran, 1983). This claimed many lives and properties worth millions of Naira.

Several anthropogenic factors have contributed to the incidence of flood. Among these factors is the encroachment of development to flood prone areas. The incursion into such areas have being progressive until now because of unprecedented urbanization and industrialization which has undoubtedly resulted into large scale massive deforestation, loss of surface vegetation and farmlands. According to Okechuckwu (2008); "the incursion of unplanned and uncontrolled development into urban infrastructure facilities, violate the major objectives of physical planning and consequently result into misuse of land thereby creating disorderly arrangement of urban landscape and the occurrence flood that is mostly evident in cities of third world countries".

In Nigeria, the incidents of flood is becoming a reoccurring decimal in most urban area leading to colossal loss of properties and lives. For example in 1973, 1974 and 1976, cases of floods were recorded in Ilorin (Jimoh, 1999; Mordi, 2011 and Amaize, 2011) in 1973, 1980 and 2011 Ogunpa flood in Ibadan occurred. Floods in low-

lying coastal areas, such as Lagos, Port Harcourt, Warri, Sapele and Yenegoa, as well as the hinterland and arid semi arid places like Ondo, Ilorin, Makurdi, Kaduna, Minna, Borno and Gombe have formed Nigeria newspaper headlines. Concern over the incidents of floods, especially in urban areas, have attracted several studies focusing on different aspects (Akintola, 1978; Akintola, 1982; Odemerho, 1983; Ayoade and Akintola, 1980; Babatolu, 1997; Oriola, 2000; Ologunorisa, 2004; Ali, 2005; Ologunorisa and Tersoo, 2006; Aderogba, 2012 and Aderogba et al., 2012).

This research focuses on incidences of flooding in Okitipupa, its impacts and proffer a remedial and management for flood menace in Okitipupa, Ondo State, Nigeria.

## **LITERATURE REVIEW**

Flooding is a common phenomenon all over the world. It is more rampant and distressing in the developing countries like Nigeria (Andjelkovic,2001). According to Ajie and Frank (2019), it is regarded as the worst natural disaster across the globe responsible for one-third of all natural exigencies with grave impairments on infrastructure, the built environment and human life. It becomes a source of concern to all and sundry looking at the fact that, whether developed or developing, no nation is immune to incidents of flooding.

The European Union (EU) Floods directive (2007), defines a flood as a temporary covering by water of land that is not normally covered by water. Flooding is normally caused by natural weather events as heavy rainfall and thunderstorms over a short period, prolonged rainfall or extensive rainfall. It can also be caused by high tide combined with stormy conditions. Flood may also result from overflowing of a great body of water over land and extreme hydrological events or an unusual presence of water on land to a depth which affects normal activities (Olajuyigbe, 2012).

The social disruptions cause by flood can seriously undermine the quality of life of individuals and impression on the fabric of affected communities (Gordon,2004). Flood in more than 80 countries has killed millions of people and caused hardships for more than 17million worldwide since the beginning of 2002. The effects of flood on man cannot be overemphasized because it cut across all spheres of man's life. This includes man's physical environment, man's health and agriculture products. Flood, depending on its volume and velocity can damage any type of structure, including bridges, cars, buildings, sewerage systems, roadways, and canals. It can also result into contamination of water (Aliyu and Suleiman, 2016). The consequence of this is unhygienic condition in the affected areas making the victims vulnerable to water-borne diseases such as; cholera, dysentery, typhoid. Crops and food supplies are often affected and consequently resulting to shortage of food crops resulting from loss of entire harvest. Its effect is also obvious on trees thereby causing non-tolerant species to die from suffocation. It also affects transportation system by destroying transport links. Conversely, lowlands near rivers depend upon river silt deposited by floods to improve the nutritional value to the local soil ( Adebayo and Jegede, 2010).

## METHODOLOGY

### Study area:

The research was carried out in Okitipupa area of Ondo State. The present Okitipupa Local Government came into being after splitting Ikale Local Government into Irele and Okitipupa Local Governments in 1991. The Old Okitipupa Division is now split into Okitipupa, Irele, Ilaje and Ese-Odo Local Governments. The Local Government lies between Longitudes 4035' and 4050' East of Greenwich Meridian and latitudes 6015' and 6025' North of the Equator within the tropical rainforest zone of Nigeria. It has a population of about 233,565 as at 2006 census and covers a land area of about 803 km<sup>2</sup>. It is bounded on the east by Irele and Ese-Odo Local Government while to its west lies Odigbo Local Government and part of Ogun State. To its north lies Odigbo Local Government while it is bounded in the south by Ilaje Local Government.

An udic soil moisture regime and isohyperthermic soil temperature regime prevail in the area with total annual rainfall often exceeding 2000mm while the soil temperature has a narrow range of 270 to 280C. the geological formation of the area is the Precambrian Basement Complex. Geomorphologically, the northern parts of the study area have strongly sloping to undulating landscapes of 8 to 12% slopes while the central and southern parts have nearly level to gently sloping landscapes of 0 to 4% slopes.



Figure 1: Map of Ondo State showing Okitipupa

### Data collection:

The sources of data employed for this research includes both secondary and primary data sources. The primary source of data were collected through the use of 200 questionnaire. The sampling technique adopted for this study is random sampling technique. The secondary data include information obtained from publications such as textbooks, journals, official documents, previous research works as well as newspapers on the various occurrences of flood disasters and pertinent issues relating to the subject.

The data collected for this study were analyzed using the simple percentage statistical method and presented using pie chart.

## RESULTS AND DISCUSSION

### Causes of flood in Okitipupa

Identification of the causes of flood is important in order to know the factors contributing to the loss of life, properties and resources which in turn influences the sustainability of life. Identification of the factors will help residents to take appropriate measures to halt them. The major causes of flooding in Nigeria urban areas include high intensity of rainfall, blockage of natural and artificial water ways, building on floodplains, improper planning and poor land use, poor drainage system and dumping of wastes into drainage. (Ologe, 2002; Oriola, 2000; Ali, 2005; Ologunorisa and Tersoo, 2006).

Considering the various factors that may have contributed to flooding as shown in Figure 2, the cause of flooding with the highest percentage of 21.5% is high intensity of rainfall as one of the causes of flooding while 21% indicated that dumping of waste materials and refuse into drainage is another cause of flooding. Poor waste management is one of the anthropogenic factors contributing to and worsening the already difficult flooding problem in Nigeria (Ojo and Adejugbagbe, 2017). The poor attitude of Nigerians to waste disposal has been widely discussed in various studies (Eneji et al., 2016; Ojo and Adejugbagbe, 2017; Olukanni, Adebayo and Terebe, 2014). Further analysis of causes of flood reveals that 18.5% perceived that blockage of natural and artificial waterways also causes flooding. Drainage blockages linked to poor sanitation practices are common in Nigeria. Roadside dumping, canal dumping and dumping in rains are commonly practiced among a large proportion of the population. This blockage results in flooding during the rainy season (Onwuemele, 2012). 16.5% of respondents considered building on floodplain as a cause of flooding in the area. The degree of built up area limits infiltration and increase runoff. This is consistent with findings from studies carried out by Anderson (1970), Akintola (1978) and Oriola (2000) in Virginia, Ibadan, Ilorin and Ondo towns respectively.

Poor drainage system is believed by 14% of the respondents to be another factor substantially aiding flooding in the study area. This is a major human-induced exacerbator of the flooding experienced in Nigeria (Ogundele and Jegede, 2011). Most residential areas in Nigeria have no drainage system and rely on natural drainage channels and it is common for buildings and other infrastructure to be constructed in a manner that actually obstructs these drainage channels which results in flooding during the rainy season (Nabegu, 2014) while 8% believed that improper planning and poor land use facilitated events of flooding in the area.

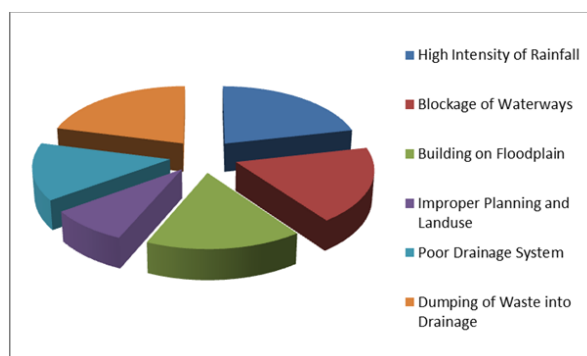

Figure 2: Causes of Flood in the Study Area

### Impact of flooding on residents

Flooding has the potential to have wide-ranging impacts within the community if affects causing significant disruption to day-to-day life, communications and to both local and potentially national economies (Douglas, 2017). Figure 3 shows the impact of flooding on residents of Okitipupa. The victims of flood in the area have always had to live with the consequences of the flood disaster. According to the result of the analysis, it has been realized that a larger percentage of the respondents (26.5%) reported that flood incidence in the past has been responsible for the destruction of properties. This can often bring serious hardship to residents in the aftermath of the flood due to inadequate or more often lack of insurance cover while 22.5% of the respondents have lost the properties to flooding. 24% of the respondents reported that flooding disrupt their day-to-day activities. In addition to the disruption, floods also damage public road surfaces through the creation of potholes that make water, transportation and ease of movement difficult. From Figure 2, 21.5% of the respondents have been displaced and forced to move out of their houses while 5.5% of the respondents classifies their loss to be the loss of relatives and loved ones.

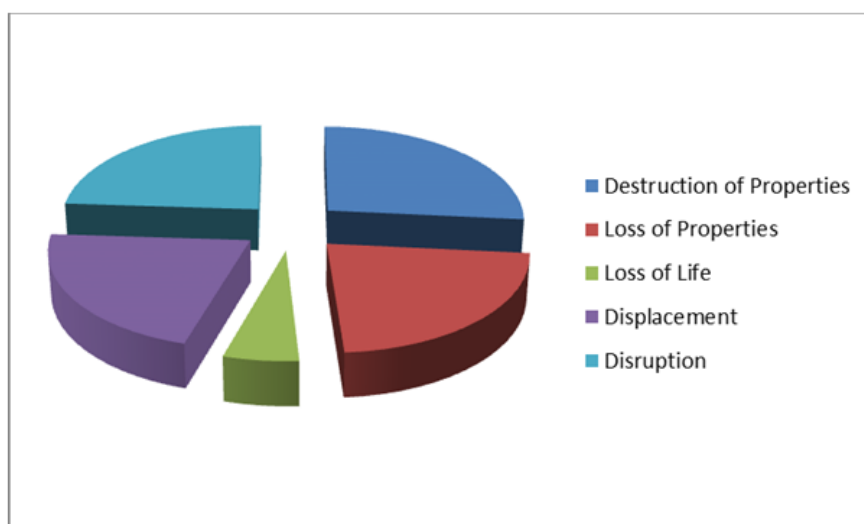

Figure 3: Impacts of Flooding in the Study Area

### Human response to flooding

Flooding control according to Bariweni, et al. (2012) refers to all methods used to reduce or prevent the detrimental effects of flood water. There are various measures that have been employed in the control of flood in the area. Among these measures are proper use of drainage system, proper refuse disposal, construction of drainage where there is none, proper land use planning, use of sandbags and river channelization. Figure 4 reveals that 21% of the respondents adopted the proper use of drainage system to control flood while 18% and 17.5% adopted the construction of drainage where there is none and river channelization and these was achieved through the assistance of the government. 16% adopted proper refuse disposal. According to the respondents, this method reduced the risk of flood because people do not dump their waste into the drainage system again. 14.5% adopted the proper land use planning while 13% adopted the use of sand bags.



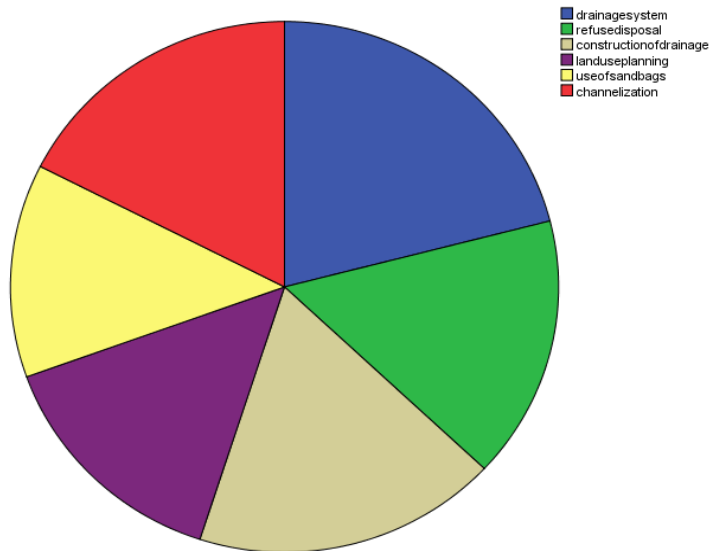

Figure 4: Human Response to Flooding

### Management Strategies of Flood Control

The consequences of flooding are detrimental and the basic consequences of flooding include loss of human lives, submerging of residences and streets, inflow to sewage, municipal pollution, damage to properties, health hazards, cleanup cost, disruption of services, traffic obstruction, aesthetic discolouring, economic loss and infrastructural damage. Thus, taking all measures to combat floods are more than necessary in any society. These measures will help control periodic inundation in the areas that are liable to flooding in the following ways:

1. A well planned drainage system which can accommodate the localized heavy rains in the metropolis should be put in place by both the state and local governments.
2. Flood zoning ordinances and land use control acts should be enacted by the state government. This will be to restrict future buildings in flood plains.
3. Repair and construction of these drainages where necessary should be embarked on to further ease the flow of storm water. Also, excavation of solid waste and other deposits which are present in the existing canal at Iju, within the local government.
4. Environmental sanitation program must be made compulsory and appropriate agency should be vested with the power to punish residents who fail to adhere to the rule of sanitation. There should be fines and penalties for people who fail to comply with the sanitation program.
5. Public enlightenment programmes should be organized to educate the public on the dangers of flood disaster and its causes as a result of the habit of throwing and dumping refuse in gutters, drainage paths and river channels. There is also need for government to set up various information programmes to educate the masses on how to respond to flood disaster.
6. The road network in the study area lacks drainage system to the extent that water overflow on the road during heavy rainfall. Thus, the state government

along with the local government should embark on the construction of wide and deep drainage system that can withstand heavy water flow.

## CONCLUSION

Water will always find its own path if not channelized by man. The need to research into the causes of flood and provide adequate flood management strategies is an aspect of environmental management that planners must pay ample attention to if they want to make the environment a haven. There is an urgent need for a collaborative effort of both government and stakeholders to support town planning, engineering and other professional agencies to combat flooding in Okitipupa to avoid long-range consequences. The improvement of roads and accessibility of cities, provision of funds and equipments for disaster management agencies is critical to abating disasters in the Nigerian urban environment and even in the rural areas too.

Although, studies conducted in different areas, have shown that, a hundred percent (100%) success may not always be achieved in eradication of flooding problems especially in urban environment yet, their damaging effects can be mitigated through management measures that are carefully designed by government or affected communities. These must be effectively and economically supervised and funded.

## REFERENCES

- Adebayo, W. O., & Jegede, O. A. (2010): The Environmental Impact of Flooding on Transportation Land Use in Benin City, Nigeria. *African Research Review*, Vol.4 No 1 pp. 390-400.
- Aderogba, K. A. (2012): Global warming and challenges of flood in Lagos Metropolis, Nigeria. *Academic Research International*. Vol. 2 No 1 pp. 448 – 468.
- Aderogba, K., Oredipe, M, Oderinde, S., & Afelumo, T. (2012): Challenges of poor drainage systems and floods in Lagos Metropolis, Nigeria. *International Journal of Social Sciences and Education*. Vol.2 No. 1 pp 413 – 434.
- Ajie, U. E., Frank, B. M. S. (2019): Investigation of Flood Vulnerability in Parts of Rivers State using Remote Sensing and GIS. *International Journal of Scientific & Engineering Research*, 10(8): 230-245. [www.ijser.org](http://www.ijser.org)
- Akintola, F. (1978). The hydrological consequences of urbanization: A case study of Ibadan city In: Sada, P. O. and Oguntoyinbo, J. S. (eds) *Urbanisation processes and problems in Nigeria*, 151-160, Ibadan University Press, Nigeria.
- Akintola, F. (1982): Flooding problems at Ibadan Western Nigeria, *Nigeria Geographical Journal*, Vo.9, 101-112.
- Ali, P. I. O. (2005): Flood damage assessment in Makurdi town, Unpublished M.Sc Thesis, Department of Geography, Benue State University, Makurdi, Nigeria.
- Aliyu, H. I., & Suleiman, Z. A. (2016): Flood Menace in Kaduna Metropolis: Impacts, Remedial and Management Strategies.
- Amaize, E. (2011): "Flood displaces 50 Villagers in Delta State", in *Vanguard: Towards a Better Life for the People*. Lagos: Vanguard Media Limited. (Monday, July, 4). p. 9.21

- Anderson, D. (1970): Effect of urban development on flood in Northern Virginia, UGSS Water Supply paper, 1591-1598.
- Andjelkovic, I. (2001): International Hydrological Programme: Guidelines on Non-structural Measures in Urban Flood Management, UNESCO, Paris.
- Ayoade, J. O., & Akintola, F. (1980): Public perception of flood hazards in two Nigerian cities, *Environmental International*, Vol.4, 277-280.
- Babatolu, J. S. (1997): The June 24th 1995 Flood in Ondo Antecedent and Incident, *Life Research Publications in Geography*, Vol.6, 125-136.
- Bariweni, P., Tawari, C., & Abowei, J. (2012): "Some Environmental Effects of Flooding in the Niger Delta Region of Nigeria". *International Journal of Fisheries and Aquatic Sciences*, 1(1): 35-46
- Douglas, I. (2017): Flooding in African cities, scales of causes, teleconnections, risks, vulnerability and impacts. *International Journal of Disaster Risk Reduction*, 26, pp.34-42. DOI: 10.1016/j.ijdrr.2017.09.024.
- Duru, P. N., & Chibo, C. N. (2014): Flooding in Imo State Nigeria: The Socio-Economic Implication for Sustainable Development. *Humanities and Social Sciences Letters*, 2(3): 129-140.
- Eneji, C. V. O., Eneji, J. E. O, Nyoka, V., & Abang, M. (2016): Attitude Towards Waste Management and Disposal Methods and the Health Status of Cross River State, Nigeria. *SCIREA, Journal of Agriculture* 1 (2): 231-247.
- European Union (EU) Floods directive (2007): "DIRECTIVES", date accessed accessed 16th February 2021 from <http://eur-lex.europa.eu/LexUriServ/LexUriServ.do?uri=OJ:L:2007:288:0027:0034:EN>: PDF.
- Geoscience Australia, (2013): What is Flooding? Retrieved from: <http://www.ga.gov.au/hazards/flood/flood-basics/what.html>
- Jimoh, H. I. (1999): Effects of run-off on sediment transportation and deposition in Ilorin City, Nigeria. *Centre Point Journal* vol.7. No2. Pp. 97-100.
- Mordi, R. (2011): "The Tsunami in the making". *The Tell: Nigerian Independent Weekly*. Lagos: Tell Communications Limited. No. 29 (July 25), pp. 54 - 63.
- Montoya Morales, A. L. (2002): Urban disaster management: A case study of earthquake risk assessment in Cartago, Costa Rica, ITC, Netherlands.
- Nabegu, A. B. (2014): Analysis of Vulnerability to Flood Disaster in Kano State, Nigeria. *Greener Journal of Physical Sciences* 4(2): 22-29.
- Odermerho, F. O. (1988): Case study of urban flood and problems in Benin City in Sada, P. O., & Odermerho, F. O. (eds), *Proceedings of the National Conference on Environmental Issues and Management in Nigerian Development*, 179-195.
- Ogundele, J., & Jegede, A. O. (2011): Environmental Influences of Flooding on Urban Growth and Development of Ado-Ekiti, Nigeria. *Studies in Sociology of Science* 2 (2).
- Ojo, O. O., & Adedugbagbe, J. A. (2017): Solid Waste Disposal Attitude in Sango Ota, Ogun State: Implication for Sustainable City Development in Nigeria. *Journal of Environment and Waste Management* 4(3): 253-260.
- Okechuckwu C. A. (2008): "Consequences of Unplanned and Uncontrolled Environmental Physical Development in Nigeria Cities", Adekunle et all (eds) *Being a Paper Delivered at 11th Annual National Conference on Environmental Sustainability in a Democratic Government Held at Federal University of Akure (FUTA)*, pp. 268-273.

- Olajuyigbe, A. E., Rotiwa, O. O., & Durojaye, E. (2012), "An Assessment of flood Hazard in Nigeria; the case of mile 12, Lagos, Mediterranean", *Mediterranean Journal of Social Sciences*, Vol. 3 No. 2, pp. 367–376.
- Olaniran, J. (1983): "An Agenda for a New Millennium"; A Proceeding of the 7th Obafemi Awolowo Foundation Dialogue; African Press, Ibadan, pp. 5-24
- Olatona, O. O., Obiora-Okeke, O. A., & Adewunmi, J. R. (2017): Mapping of Flood Risk Zones in Ala River Basin Akure, Nigeria. *American Journal of Engineering and Applied Sciences*, 11(1): 210-217.
- Ologe, K. O. (2002): "Nigeria – Relief and Hydrology." Atlas of Nigeria les Edition. J. A. Paris – France. pp57 - 59.
- Ologunorisa, E. T. (2004): An assessment of flood vulnerability zones in the Niger Delta, Nigeria, *International Journal of Environmental Studies*, Vol.61,31-38.
- Ologunorisa, E. T., & Tersoo, T. (2006): The changing rainfall pattern and its implication for flood frequency in Makurdi, Northern Nigeria, *Journal of Applied Science and Environmental Management*, Vol.10(3) 97-102.
- Oludare Hakeem, A., Bashir Olufemi, O., & Olusegun Hezekiel, A. (2012): "Building Capabilities for Disaster and Hazard Preparedness and Risk reduction in Nigeria: Need for Spatial Planning and Land Management", *Journal of Sustainable Development in Africa*, Vol. 14, No.1, pp.
- Olukanni, D. O., Adebayo, R. A., & Terebe, I. T. (2014): Assessment of Urban Drainage and Sanitation Challenges in Nigeria. *International Journal of Emerging Technology and Advanced Engineering* 4 (12): 100-105.
- Onwuemele, A. (2012): "Chapter 11: Cities in the Flood: Vulnerability and Disaster Risk Management: In Urban Areas and Global Climate Change, edited by W.G. Holt. Emerald Group Publishing Limited.
- Oriola, E. O. (2000): 'Flooding and Flood Management. 'in H. I. Jimoh and I. P. Ifabiyi (Eds.) *Contemporary Issues in Environmental Studies*. Ilorin: Haytee Press & Publishing Coy. pp 100 - 109.
- Saleh, U. R. (2014): Impacts of Flood on the Lives and Livelihoods of People in Bangladesh: A Case Study of a Village in Manikganj District. Unpublished Master's Thesis, Brac University, Dhaka, Bangladesh. [www.dsplace.bracu.ac.bd](http://www.dsplace.bracu.ac.bd)



## ASSESSMENT OF THE CHALLENGES AND SOLUTIONS TO IMPLEMENTATION OF SAFETY MEASURES BY SMALL AND MEDIUM SIZED CONSTRUCTION FIRMS IN ABUJA, NIGERIA

Jibril Adamu Muhammad<sup>1</sup>, Abdullateef Adewale Shittu<sup>2</sup>, Yakubu Danasabe Mohammed<sup>3</sup>, John Ebhohimen Idiake<sup>4</sup> and Zannah Alhaji Ali<sup>5</sup>

<sup>1,2,3,4</sup>*Department of Quantity Surveying, Federal University of Technology Minna, Niger State, Nigeria*

<sup>5</sup>*Department University of Maiduguri Borno State Nigeria*

Studies have revealed that construction firms lack proper implementation of safety measures on construction projects in Abuja, Nigeria. Construction works all over the world therefore pose serious threat to workers and non-workers in most of the developing countries such as Nigeria. This paper assessed the level of implementation of safety measures by small and medium sized construction firms (construction SMEs) in Abuja with a view to improving the safety performance of construction firms. This was achieved through: identification of the effective safety measures required on construction sites; examination of the challenges affecting the implementation of safety measures on construction sites; and suggesting strategies for improving the level of implementation of safety measures by construction SMEs. Data were obtained from selected construction SMEs in Abuja using structured questionnaire distributed to 50 randomly selected SMEs with a response rate of 92%. Relative Importance Index (RII) and Mean Item Score (MIS) were employed for data analysis. It was revealed that the use of personal protective clothing (MIS = 4.54) is the most effective safety measure required on construction sites. It was also found that ineffective management commitment (MIS = 4.63) is the most severe challenge affecting the implementation of safety measures by construction SMEs. The study also found that provision of personal protective equipment (RII = 0.94) is the most effective strategy for improving the level of implementation of safety measures on construction sites. It was however concluded that the level implementing safety measures by construction SMEs in Abuja is low. Therefore, this research recommends that construction stakeholders should encourage, ensure, and promote the proper implementation of safety measures in construction SMEs. This will assist to curb the challenges inhibiting safety measures implementation so as to improve the safety performance of construction SMEs.

Keywords: construction firms, construction SMEs, safety measures

---

<sup>1</sup> adamujibril@gmail.com

<sup>2</sup> funsho@futminna.edu.ng

<sup>3</sup> yaksmoves@yahoo.com

<sup>4</sup> jeidiake@futminna.edu.ng

<sup>5</sup> zannah2200@gmail.com

## INTRODUCTION

The construction industry is an important sector of the economy in many countries and it is often seen as a driver of economic growth by contributing to Gross Domestic Product (GDP), capital formation, and employment especially in developing countries (Phoya, 2012). Diugwu et al., (2012) state that construction industry in developing countries have performed far below expectation in the area of health and safety (H&S), the situation in Nigeria is no exception. This is due to the fact that the existing legislation with regards to occupational H&S in Nigeria is not functional (Umeokafor et al., 2014). According to Nzuve and Lawrence (2012) low level of inspection and examination of workplaces might determine the level of compliance with occupational safety and health (OSH) regulations as evident in workplaces in Nairobi. The same can be said of Nigeria, where lack of enforcement characterizes regulatory institutions (Idubor and Osiamoje, 2013), most laws appear to fulfil all righteousness or are used for political or victimization reasons, and the institutions alleged and proved to be corrupt and arbitrarily exercise its powers (Zou and Sunindijo, 2015).

Koehn et al., (2013) also observed that framework for the implementation of safety measures applies mainly to the large scale multinational construction firms. Therefore, little or no emphasis is laid on the small and medium sized construction firms in Nigeria.

Diugwu et al., (2013) opined that Nigeria is among the countries having no adaptive H&S measures and regulations where small and medium sized construction firms allocate little or no resources to H&S management. Bima et al., (2015) revealed that legislation on H&S are endorsed by the Nigerian government, including International Labour Organization (ILO) conventions. However, their implementation by the relevant government bodies and workers is poor (Shittu et al., 2015a and b; Shittu et al., 2016; David et al., 2018). Awwad et al. (2016) added that safety practices lack necessary framework for the implementation of safety measures on construction projects with particular emphasis to the small and medium sized construction firms (construction SMEs) and thus leading to increase in accidents on construction sites and cost of compensation to injured workers. This brings about ineffective cost performance of projects.

Frameworks facilitate the assessment of the effectiveness of construction firms, identify the deficiencies and the weaknesses, and create procedures to manage the accident in future by controlling the safety behaviour of employees. Gurcanli et al. (2015) observed that studies on the cost of safety measures as a part of project costs during a construction project are very rare. This is a gap left by these studies from the global scene. The Nigerian construction industry researches carried out on health and safety include: application of H&S plan in Nigerian construction firms (Dodo, 2014); enforcement of OHS Regulation in Nigeria (Umeokafor et al., 2014); influence of organizational characteristics on H&S practices of construction firms in Abuja; and evaluation of accidents and safety in the Nigerian construction industry (Aniekwu, 2017).

In summary, the previous studies on H&S appear to have been conducted to investigate on safety costs involved in the construction stage. But there exist

limited studies on effective implementation of safety measures by construction SMEs in Nigeria as the existing ones are applied to larger construction firms and are particular to foreign and multi-national construction firms which are characterized with shortcomings of not capturing the peculiarities of SMEs in Nigeria. This paper will fill this research gap by assessing the level of implementation of safety measures by construction SMEs in Abuja with a view to improving the safety performance of construction firms. A larger study (Doctoral research) will then develop a framework for effective implementation of safety measures by small and medium sized construction firms in Nigeria. This paper is therefore a part of this larger study. In order to achieve the aim of this paper, the following objectives were formulated:

1. Identify the effective safety measures required on construction sites by construction SMEs. Using relative importance index (RII).
2. Examine the challenges affecting the level of implementation of safety measures on construction sites by SMEs.
3. Suggest strategies for improving the level of implementation of safety measures on construction sites by SMEs.

## REVIEW OF LITERATURE

### **The construction industry**

The construction industry is considered as a leading driver of economic development in a country. Belel and Mahmud (2012) state that the construction industry brings significant contribution and benefit in facilities production which initiates various economic activities and enhance the social and environmental needs of a nation. Thus construction safety becomes one of the significant concerns.

The construction industry is unique among all other sectors because it provides the necessary infrastructures that stimulate national development (Jackman, 2010). Nigeria being the most populous country in Africa and also the largest economy in Africa according to (World Bank, 2016) its construction industry plays an important role in the nation's economy. In 2012 the sector's contribution to national gross domestic product stood at 3.05% and in that same year the sector employed an estimated amount of 6.9 million workers (National Bureau of Statistics, 2015).

Occupational Health and Safety (OHS) is well recognised in the construction industry as one of the most important subjects. The implementation of OHS measures in the industry is critical for the protection of all project stakeholders (Lingard, et al., 2015). Despite the persistent endeavours that have been made to improve and promote construction safety (Sherratt, et al., 2015) those accidents still plague the industry (Zhou, et al., 2015).

### **The concept of small and medium-sized construction firms**

The Nigeria Bureau of Statistics (NBS) and (SMEDAN) (2012) categorised construction firms with 25 employees as small but this has been considered an unsuitable definition considering the high level of subcontracting in the

construction industry (Eyiah 2004). The definition of SMEs in the Nigerian context, like in the UK and many other countries, varies between researchers and government institutions of the country. SMEs are broadly defined as business with turnover of less than 100 million per annum and/or less than 300 employees. Onugu, (2005) NBS and SMEDAN (2012) added that about 81% of construction SMEs in Nigeria is small-scale enterprises while about 19% are medium (NBS and SMEDAN, 2012). Majority of the Nigerian construction SMEs are sole proprietorship business enterprises; that is about 92% of the Nigerian construction SMEs are sole proprietorship mode. The highest number of the owners/managers of the Nigerian construction SMEs is of ages between 36 and 50 years and this constitutes about 42% of the total population of the Nigerian construction SMEs. The Nigerian construction SMEs have a great contribution to the Nigerian economy in terms of the building and construction investment; that is the Nigerian construction SMEs contribute to about 11% of the Nigeria's Gross Domestic Product (GDP) in 2010 (NBS and SMEDAN, 2012).

The regulations of OSH in Nigeria has received little attention, with little emphasis to strict adherence to safety in the construction industry and very minimal impact made by the inspection officers towards ensuring strict compliance. The accidents record in Nigeria indicate an alarming rate of injuries and fatalities on sites (Diugwu et al., 2012). Hence, there is need to find a way of minimizing the rate of falls and injuries in Nigerian construction industry.

#### **Effective health and safety measures required on construction sites**

Construction industry is considered one of the most hazardous industries because of its unique nature (Fang and Wu, 2013). It comprises of a wide range of activities (both construction and repair) that rely intensively on labourers, heavy machinery and equipment. Construction workers engage in many activities that may expose them to serious hazards, such as falling from rooftops, encountering unguarded machinery, and being struck by heavy construction equipment (Popov et al., 2016). Therefore, safety procedures related to the construction industry or project sites have been established in different countries (Muiruri and Mulinge, 2014) to ensure that construction sites or the industry are not the cause of immediate danger to the public or workers at a project site. Construction safety regulations are also useful for ensuring that every finished product meets the required safety standards.

#### **Health and safety regulations**

Research studies trace the origin of H&S regulations generally to the UK and US (Sunil& Hari., 2019). Nigeria as a former colony of Britain depended solely on standards and regulations of her colonial master before and even after independence. As a result, almost all existing regulations of reference on H&S in Nigeria originated from foreign countries (Kolawole 2014).

Chudley and Greeno (2016) defined construction regulations as statutory instruments setting out the minimum legal requirements for construction works and relate primarily to the health, safety and welfare of the workforce which must be taken into account when planning construction operations and during the actual construction period. Regulation cannot on its own be effective without enforcement. Idubor and Osiamoje (2013) opine that regulations without proper enforcement are tantamount to no laws.



Globally, health and safety regulations governing the construction industry and other work related industries exist. In Nigeria also, a number of legislations on occupational health and safety exist. These include; Labour Act of 1974 modified to Labour Acts 1990, and updated to Labour Act, Cap L1, Laws of the Federation of Nigeria (LFN), 2004; the Factories Act of 1987 which became effective in 1990 and later updated to Factories Act, Cap. F1, LFN, 2004 Federal Government of Nigeria, "The Factory Act Of 1990"; the Workman's Compensation Act of 1987 which became effective in 1990, modified to Workman's Compensation Act, Cap W6, LFN, 2004 and repeal to Employee's Compensation Act, No. 13, 2010 of the laws of the Federal Republic of Nigeria, "Factories Act 126 Cap. F1 LFN. 2004," Federation of Nigeria (2010) the Insurance Act, 2003 and the Labour, Safety, Health and Welfare Bill of 2012 including the National Building Code Enforcement Bill which has suffered huge political setback over the years, and is yet to be passed into law by the National Assembly.

In spite of numerous statutory provisions and expectations in Nigeria, gap still exist in health and safety. This problem is linked to adopting almost all existing regulations of reference on health and safety in Nigeria from foreign countries, especially from the British legal system with little or no changes made. Kolo (2015) observed that some provisions from these laws do not necessarily meet the conditions experienced in Nigeria.

Dodo (2014) linked the problem to adopting almost all existing regulations of reference on health and safety in Nigeria from foreign countries, especially from the British legal system with little or no changes made.

Nevertheless, the emergence of new regulations, laws, standards and codes has made many construction organisations to improve their safety performance.

### **Safety code of practice in construction industry**

The purpose of building codes and construction regulations cannot be over emphasized in project development and management, they ensure health and safety of workers, it provide habitable facilities, promotion of energy efficiency, it also facilitate sustainable development and contribute greatly to meeting the demands construction stakeholders. Muiruri ( 2014) asserted that code and regulations is not stand alone to improve construction safety at reduce cost, rather poor codes and regulations can only add to project cost without any solution to construction safety compliance. The cost arises from delays in construction progress include both direct and indirect cost on the employers and employees.

The numerous numbers of codes and regulations that support management of health and safety practice includes: The provision and use of Equipment Regulation (1992), ILO code of practice-International Labour Office (1992), The Manual Handling Operations Regulations (1992), The Personal Protective Equipment at Work Regulations(1992), The occupational safety and health act of (2007), The Health and Safety (Display Screen Equipment) Regulations (1991), Health and Safety (First-Aid) Regulations (1981), Management of Health and Safety at Work Regulations (1999), Control of Substances Hazardous to Health Regulations (2002), Construction Design and Management Regulations 2015 (CDM 2015), Nigerian National Building Code (2007) (Bamisile, 2004 and Muiruri , 2014).

### **The provision of Nigerian National Building Code**

The Nigerian National Building Code came on board after several debates and agitation by the representative of stakeholders in the built environment and government under the headship of the Minister of Housing and Urban Development. The code intended to serve as means of enhancing construction project, by disengagement of quacks and the use of 'non-tested' materials in the execution of building production. The objectives of the code is to provides solution to current challenges confronting the Nigerian building industry, this include: Inadequate town planning in Nigerian cities, occurrence of building collapse and accident related issues, dearth of construction standards for regulating building designs and production, and the poor maintenance culture in the industry.

The code stated in section 7 (49) stated the need to protect the general public and workers anytime a building production process, demolished and maintenance work are to be carried out. The following provisions were made in the code to ensure safety compliance of the operatives involved during production works on site: Section 7 (55) stated the requirement for the use of scaffolds and their components should provide support without failure at least four times the maximum intended loads.

Section 7 (60) stated the requirement for managing health hazards, every construction or maintenance operation which results in the diffusion of noise, dust, stone and other small particles, toxic gases or other harmful substances in quantities hazardous to health shall be safeguarded by means of local ventilation or other protective wears to ensure the safety of the workers and the public as required by this code.

Windapo and Jegede (2013) also noted that contractors (who are SMEs) prioritize savings cost to H &S in the Nigerian construction industry .

### **Safety policy**

A health and safety policy is a written document which recognizes that health and safety is an integral part of the building and construction industry performance. It is a statement by the industry of its intentions and approach in relation to its overall health and safety performance and provides a framework for action, and for the setting of its health and safety objectives and targets.

In every construction site or organization, Site managers should have a written safety policy for their organization setting out the safety and health standards which it is their objective to achieve. The policy should appoint a senior executive who is responsible for seeing that the standards are achieved, and who has authority to allocate responsibilities to management and supervisors at all levels and to see that they are carried out. Construction safety policy must therefore be developed by each site manager and operating company prior to starting any construction job. Once developed the development safety plan should be placed into a training program that's needed to be participated in by every site worker previous to partaking in any job found on the positioning irrespective of the roles simplicity. The absence of site meetings as established in this survey implies that workers are not given a forum learn about various risks on the sites and Supervisors equally do not have opportunities to communicate important health and safety

matters to the workers. Site meetings are one of the ways of sensitizing workers on their health and safety in the site and should therefore be held frequently.

The policy should indicate the intention and purposes of the industry to operate a workplace, which is drug-free, specify the kind of substances to be banned e.g. alcohol, explain the applied testing methods, state, and describe any assistance programs and penalties. Mandatory testing before hiring, testing for cause and continuous random testing should be addressed by the drug-testing program. Compulsory drug testing should be included in the employment application process.

### **Concept of safety culture in construction industry**

For a long time, the construction industry has been labelled with a poor occupational safety and health culture. Efforts to improve occupational safety and health performance will not be effective until the occupational safety and health culture is improved (Misnan et al. 2012). It is a generally accepted wisdom that an organization that develops and maintains a strong safety culture is more effective at preventing individual and large scale accidents (Agwu and Oledede, 2014). Agwu and Oledede (2014) in Mbuya and Lema (2016) opined that in most developing countries, safety consideration in construction project delivery is not given a priority and the employment of safety measures during construction is considered a burden. Enhassi et al., (2015) reported that in many developing countries, the legislation governing Occupational Health and Safety is significantly limited when compared with UK. They further reported that there are rarely any special provisions for construction workers 'safety and the general conditions of work are often not addressed. Agwu and Oledede (2014) reported that in many of the countries where safety legislation exists, the regulatory authority is weak and non-existent and employers 'pay lip service 'to regulations.

### **Challenges affecting the implementation of health and safety measures on construction sites**

According to Nzube and Lawrence (2012) low level of inspection and examination of workplaces might determine the level of compliance with occupational safety and health (OSH) regulations as evident in workplaces in Nairobi. The same can be said of Nigeria, where lack of enforcement characterizes regulatory institutions (Idubor and Osiamoje, 2013). Furthermore, Okojie, (2010) argues that insignificant penalties stipulated by the OSH laws do not guarantee compliance in any way, suggesting that penalties should serve as indirect instruments for enforcement of OSH regulations; that way, it can serve as deterrent to offenders. Diugwu et al., (2012) argue that lack of resources can hinder occupational safety and health (OSH) management efforts. Conclusively, strict enforcement, weak national occupational health and safety standards, lack of adequate information, bribery and corruption, management commitment, weak legal structure, beliefs, lack of funding, and lack of awareness and improper medium for information dissemination are some of the challenges reviewed.

Other challenges of H &S measures implementation for construction SMEs include the following:

- I. Poor Supervision and Monitoring
- II. Inadequate training and retraining

- III. Low capitalization
- IV. Poor policy implementation
- V. Poor budgetary provision and implementation
- VI. Lack of enabling environment (Social, Political, Legislative, macroeconomic and bureaucratic obstacles).

### **Strategies for improving the level of implementation of safety measures on construction sites**

Ghousi et al., (2018) described a safety program as a fundamental and necessary basic program for building construction projects. Ghousi et al. (2018) further explained that a successful safety program must have three essential parts: Personal Protective Equipment (PPE), safety measures or Collective Protective Measures (CPM) and safety training. Construction sites are dangerous places, and as such first aid and rescue equipment should always be available. Work in the construction industry is tedious and involves much manual or physical activity. It is also hazardous and dirty and therefore good welfare facilities not only improve workers' welfare but also enhance efficiency. In order to reduce hazards and accidents in a construction site, health and safety risk assessment is an important measure (El-Mashaleh 2010). Safety strategies reviewed include safety program, first aid kit and accident reporting, welfare facilities, safety promotion, safety personnel salary, health and safety file, health and safety risk assessment, site layout and planning, and working environment (Jannadi & Bu-Khasim 2002).

Other strategies for improving the Level of Implementation of Safety Measures on construction Sites include;

#### **First aid kits and accident reporting**

According to Nzuve & Lawrence (2012) Construction sites are dangerous places, and as such first aid and rescue equipment should always be available. What is needed depends on the size of the site and the numbers employed, there should be a blanket and a stretcher. On large sites with more than 200 employees, there should be a properly equipped first aid room.

On any construction site of that size, at least one person on every shift should have been trained in first aid to a nationally recognized standard. On day-to-day works procedures, an accident register book should be kept at the site, in which all types of minor injury such as bruises, to major accidents should be recorded (HSE 1998).

Most of the construction sites that had first aid boxes were ill equipped with only spirit, bandage, paracetamol and cotton wool. First aid is a lifesaving exercise which is taken for granted on the sites visited and shows that workers are exposed to danger and risks when injured.

#### **Welfare facilities**

Work in the construction industry is tedious and involves much manual or physical activity. It is also hazardous and dirty and therefore good welfare facilities not only improve workers' welfare but also enhance efficiency. Welfare facilities such as the provision of drinking-water, washing, sanitary and changing accommodation, rest-rooms and shelter, facilities for preparing and eating meals, temporary housing, assistance in transport from place of residence to the work site and back, all help to reduce fatigue and improve workers' health.

Therefore health and safety measures employed on construction sites are inadequate and fail to meet the required standards. The culture and attitude of construction workers and the site supervisors about health and safety often condone risk taking and unsafe work practices. Lack of proper information and ignorance are also to blame for the poor safety measures in construction sites. For instance some workers felt that the safety equipment's such as hard helmets and reinforced boots are too cumbersome and uncomfortable.

### Health and safety risk assessment

In order to reduce hazards and accidents in a construction site, health and safety risk assessment is an important measure. In the context of health and safety, common definitions used for risk are that: risk is the likelihood of a substance to cause harm; and risk is a combination of the likelihood of an occurrence of a hazardous event or exposure(s) and the severity of injury or ill health that can be caused by the event or exposure.

The Health and Safety Executive (HSE,1998) defined risk assessment as a process that identifies the hazards associated with particular activities/tasks, evaluates the effects of exposure to these hazards and implements the measure needed to control the risk of injury/ill health to as low a level as possible.

## RESEARCH METHODOLOGY

This study adopted a quantitative research approach this is due to high rate of accidents that occur in the construction SMEs. The study encompassed a review of literature survey from journals, conference papers and past projects to assess level of implementation of safety measures for small and medium sized construction firms. Data were collected from both primary and secondary sources. The use of questionnaire was employed to gather data for this study. Descriptive statistics comprising of Relative Importance Index (RII) and Mean Item Score (MIS) were employed to analyse the data collected in order to achieve the research objectives. The use of RII and MIS for the analysis of data in this study is based on the formula depicted in Equation 3.1 and 3.2 respectively.

$$RII = \frac{\sum W}{AXN} \dots\dots\dots (3.1)$$

Where;

$\Sigma$  = Summation, W = the weights of every one of the factors given by respondents and it was in the range of (1 - 5), (A=5) the largest value of weight (i.e. highest factor) and finally N refers to the Total number respondents.

$$MIS = \frac{\sum W}{N} \dots\dots\dots (3.2)$$

Where;

$\Sigma$  = Summation, W = Weight, and N = Total number respondents

The decision rule employed for the RII and MIS analysis is summarized in Table 3.

**Table 1: Decision rule for analysis of data**

SCALE	Cut-Off Point		Interpretations		
	<i>RII</i>	<i>MIS</i>	<i>Level of Awareness</i>	<i>Level of Severity</i>	<i>Level of Effectiveness</i>
5	0.81 - 1.00	4.51 - 5.00	Highly Aware	Very Severe	Very Effective
4	0.61 - 0.80	3.51 - 4.50	Aware	Severe	Effective
3	0.41 - 0.60	2.51 - 3.50	Fairly Aware	Fairly Severe	Fairly Effective
2	0.21 - 0.40	1.51 - 2.50	Unaware	Less Severe	Less Effective
1	0.00 - 0.20	1.00 - 1.50	Highly Unaware	Least Severe	Least Effective

Source: Adapted and modified from Shittu et al. (2015a)

### Reliability test

Cronbach’s Alpha test was used to measure the internal consistency or reliability of a set of items and used when the multiple Likert’s scale is adopted in a questionnaire survey. Cronbach’s Alpha Test was carried out to ascertain the reliability of the quantitative data collected for the study. Table2 Contain result of the reliability checks for the various sections of the questionnaire. The Cronbach’s alpha value of the variables tested ranges between 0.299 - 0.802, with an average of 0.587.

**Table 2 Results of Cronbach’s Alpha for Reliability Test**

S/No.	Variables Tested	Cronbach's Alpha	No. of Items
1.	Identify and assess the effective safety measures required on construction sites by SMEs	0.661	15
2.	Examine the challenges affecting the implementation of safety measures on construction sites by SMEs	0.299	10
3.	Suggest strategies for improving the level of implementation of safety measures on construction sites by SMEs	0.802	15
	Average	0.587	

Source: Researcher’s field survey (2020)

## RESULTS AND DISCUSSIONS

This section describes and presents the analysis and interpretation of research data. The research which adopts a primarily sourced data using a well-structured questionnaire had been analysed. The results of the descriptive analysis are presented in Table 1 – 3. The discussion for each Table thereafter follows below.

### Result and discussion for effective safety measures required on construction sites

Table 3 presents the MIS result of the analysis on the level of effectiveness of safety measures required on construction sites.

Table 3 reveals that the use of personal protective clothing (PPC) with MIS of 4.54 and standard deviation of 0.504, safety policy with MIS of 4.15, and standard deviation of 1.010, use of first aid kits with MIS of 4.11 and standard deviation of 0.849, health and safety training with MIS of 3.98 and standard deviation of 0.906, and good working environment with MIS of 3.96 and standard deviation of 0.965 are the effective safety measures required on construction sites. This is in line with the findings of El-Mashaleh et al. (2010) where they found that undertaking regular

meeting on safety at the project level, ensuring adequate measures on safety, making available personal protection equipment (PPE), putting up safety signs and posters, undertaking regular safety inspections, establishing a system for acknowledging and awarding safe conduct are essential for safety performance on construction sites.

**Table 3: Effective safety measures required on the site of an organisation**

S/No.	Effective Safety Measures	MIS	SD	Rank
1.	Use of personal protective clothing (PPC)	4.54	0.504	1st
2.	Safety policy	4.15	1.010	2nd
3.	Use of first aid kits	4.11	0.849	3rd
4.	Health and safety training	3.98	0.906	4th
5.	Good working environment	3.96	0.965	5th
6.	Safety personnel	3.80	0.934	6th
7.	Health and safety risk assessment	3.76	0.822	7th
8.	Welfare facilities	3.70	0.866	8th
9.	Safety inductions	3.63	1.040	9th
10.	Use of posters and other signs to give safety education	3.57	1.068	10th
11.	Display of safety information clearly	3.50	0.888	11th
12.	Keep safety procedures updated	3.41	0.956	12th
13.	Safety meetings	3.37	1.082	13th
14.	Alcohol-and substance-abuse programme	3.24	1.251	14th
15.	Health and safety warning signs	3.22	0.917	15th
	Average	3.73		

Source: Researcher’s data analysis (2020).

**Result and discussion for challenges affecting the implementation of safety measures by construction small and medium sized enterprises**

Table 4 Shows the RII result of the identified challenges affecting the implementation of safety measures by construction small and medium sized enterprises.

**Table 4. Challenges affecting the implementation of safety measures by construction small and medium sized enterprises**

S/No.	Challenges	RII	SD	Rank
1.	Management commitment	4.63	0.488	1st
2.	Low level of compliance with occupational health and safety regulations	4.24	0.848	2nd
3.	Weak national OHS standards	3.96	0.759	3rd
4.	Lack of adequate information on OHS	3.59	1.166	4th
5.	Weak legal structures	3.54	0.982	5th
6.	Awareness and proper medium of information dissemination	3.39	0.930	6th
7.	Provision of safety facilities	3.26	0.976	7th
8.	Lack of funding for inspecting and H&S plan in a construction sites	3.04	0.868	8th
9.	Bribery and Corruption	2.80	1.067	9th
10.	Absence of safety representatives	2.74	1.104	10th
	Average	3.52		

Source: Researcher’s data analysis (2020)

Table 4 revealed that the most severe challenge affecting the implementation of safety measures by construction SMEs are management commitment with MIS of 4.63 and standard deviation of 0.488, low level of compliance with occupational health and safety regulations with mean score of 4.24 and standard deviation of 0.848, Weak national OHS standards with mean score of 3.96 and standard deviation of 0.759, Lack of adequate information on OHS with mean score of 3.59 and standard deviation of 1.166, and Weak legal structures with mean score of 3.54 and standard deviation of 0.982. This agrees with the findings of Nzuve and Lawrence (2012) which revealed that low level of inspection and examination of workplaces might determine the level of compliance with occupational safety and health (OSH) regulations as evident in workplaces. And contradict with the findings of Idubor and Osiamoje (2013) which assert that bribery and corruption are the biggest hindrances to proper compliance with occupational safety and health (OSH) regulations in Nigeria.

### Result and discussion for strategies for improving the level of implementation of safety measures on construction sites

Table 5 shows the MIS result on the strategies for improving the level of implementation of safety measures on construction sites.

**Table 5 Strategies for improving the level of implementation of safety measures on construction sites**

S/No.	Strategies	MIS	SD	Rank
1.	Provision of personal protective equipment	0.94	0.502	1st
2.	Provide first aid supplies	0.88	0.774	2nd
3.	Use of Building codes of practice	0.86	0.628	3rd
4.	Training and Competence	0.85	0.801	4th
5.	Communication of H&S policy and programs to staff	0.84	0.778	5th
6.	Deal with any hazards promptly	0.83	0.957	6th
7.	Training and Enforcement	0.81	0.759	7th
8.	Risk Awareness, management and tolerance	0.80	0.989	8th
9.	Safety inspection	0.79	0.904	9th
10.	Keep safety procedures updated	0.78	0.948	10th
11.	Meet fire safety standard	0.77	0.749	11th
12.	Strategic safety communication	0.75	0.899	12th
13.	Collective protective equipment such as scaffolding, safety nets fencing and accessibility	0.74	0.779	13th
14.	Display safety information clearly	0.72	1.085	14th
15.	Worksite organization	0.71	0.981	15th
	Average	0.81		

Source: Researcher's data analysis (2020).

Table 5 which highlights the strategies used for improving the level of implementation of safety measure identified provision of personal protective equipment (PPE) with the RII of 0.94 and standard deviation of 0.502, provide first aid supplies with the RII of 0.88 and standard deviation of 0.774, use of building codes of practice with the RII of 0.86 and standard deviation of 0.628, training and competence with the RII of 0.85 and standard deviation of 0.801, and communication of H&S policy and programs to staff with the RII of 0.84 and



standard deviation of 0.778 as the most effective strategy to improve the level of implementation of safety measure. This corroborate with the findings of Ikpe (2010) where he asserted that provision of personal protective equipment can be argued to be the most significant element in terms of improving the level of implementation of safety measure.

In view of that the following observations have been made;

- I. Analysis from table 3 which highlights the effective safety measures required on construction site revealed that the most effective safety measures implemented on their site(s) are; use of personal protective clothing (PPC), safety policy and use of first aid kits.
- II. Table 4 which identified the challenges affecting the implementation of safety measures by construction small and medium sized enterprises, and revealed that the most severe challenge affecting such implementation is management commitment Other severe challenges identified during the study include; is low level of compliance with occupational health and safety regulations., lack of adequate information on OHS, weak national OHS standards, weak legal structures, awareness and proper medium of information dissemination, provision of safety facilities, lack of funding for inspecting and H&S plan in a construction sites, bribery and corruption and absence of safety representatives.
- III. Table 5 which highlights the strategies used for improving the level of implementation of safety measure identified provision of personal protective equipment as the most effective strategy to improve the level of implementation of safety measure.

It was shown from the results of the MIS and RII analysis that the use of personal protective clothing is an effective measure required on construction sites and the most severe challenge affecting the implementation of safety measures by construction SMEs is management commitment. Provision of personal protective equipment (PPE) was identified as the most effective strategies used for improving the level of implementation of safety measure identified.

## CONCLUSIONS

### Conclusions and recommendations

Upon analysis, this research brought forth the following conclusions:

- Use of personal protective clothing (PPC), safety policy, use of first aid kits, health and safety training and good working environment are the most required safety measures required on construction sites of SMEs.
- Management commitment, low level of compliance with occupational health and safety regulations, weak national occupational health and safety (OHS) standards, lack of adequate information on occupational health and safety (OHS), and weak legal structures are the most severe challenges affecting the implementation of safety measures by construction SMEs.

- Provision of personal protective equipment, provision of first aid supplies, use of building codes of practice, training and competence, and communication of H&S policy and programs to staff are the most effective strategies that can improve the level of implementation of safety measures on construction sites by SMEs.
- It can finally be concluded that there is low level of implementation of safety measures on construction sites by construction SMEs in Abuja.

In view of the aforementioned conclusions and based on the findings from this research, this study recommends the following:

- Construction firms should encourage and enhance the implementation/use of personal protective clothing (PPC), safety policy, use of first aid kits, health and safety training and good working environment so as to further reduce rate of accidents and unnecessary expenses that may amount as result of accidents.
- This study recommends that firms should have a more stringent in-house rules by incorporating the 'carrot and stick' approach (that is, a combination of reward and punishment) to induce good behaviour. In addition, reduction in cost of safety training, adoption of seminars and workshops to engage SMEs to be part of OHS activities, and ensuring the right safety culture for professionals/site workers is crucial for the advancement of OHS and for the wellbeing of the workers.
- This research recommend that construction firms should ensure provision of adequate personal protective equipment, provide first aid supplies, encourage the use of building codes of practice, facilitate staff training and competence, ensure proper communication of H&S policy and programs to staff, and conduct safety inspections at predetermined intervals so as to improve the level of implementation of safety measure on construction sites by SMEs.
- Finally, organizations and construction stakeholders should encourage, ensure, and promote the proper implementation safety measures as it is intended to support small and medium sized construction firms as well as professionals in identifying safety issues, putting measures in place to curb challenges inhibiting safety measures implementation and improving on the safety practices of small and medium sized construction firms in order to enhance firm's competitive advantage and boost performance.

## REFERENCES

- Agwu, M. O., & Oledede, H. E. (2014). Fatalities in the Nigerian Construction Industry: A Case of Poor Safety Culture. *British Journal of Economics, Management and Trade* 4(3): 431-452
- Aniekwu, N. (2017). Accidents and safety violations in the Nigerian construction industry. *Journal of Science and Technology Ghana*, 27(1), 81-89.
- Awwad, R., El Souki, O., & Jabbour, M. (2016). Construction safety practices and challenges in a Middle Eastern Developing Country. *Safety science*, 83.

- Belel, Z. A., & Mahmud, H. (2012). Safety culture of Nigerian construction workers a case study of Yola. *International Journal of Scientific and Industrial Research*, 3(9), 1-5
- Bima, A. M., Ismaila, A., & Baba, D. L. (2015). Assessment of cost impact in Health and Safety on construction projects: *American journal of Engineering research (AJE)* ISSN: 2320-0847 P- ISSN: 2320 -0936, 4(3), 25-30Blackwell.
- David, B. R., Idiake, J. E., & Shittu, A. A. (2018). Effect of Health and Safety Management Practices on Safety Performance of Construction Contractors. In A. M. Junaid (Ed.) *Proceedings: School of Environmental Technology Conference (SETIC) 2018. Contemporary Issues and Sustainable Practices in the Built Environment*. 10–12 April, 2018. School of Environmental Technology, Federal University of Technology, Minna, Nigeria. Volume 1: 384– 391.
- Diugwu, I. A., Baba, D. L., & Bima, M. A. (2013). Research and Legal Underpinnings of the Quantity Surveyor as a Health and Safety Manager. In: A. D. Ibrahim, K. J. Adogbo & Y. M. Ibrahim (Eds). *Proceedings of Nigerian Institute of Quantity Surveyors: 1st Annual Research Conference – Recon. 3rd – 5th September, 2013*. Ahmadu Bello University Press Limited, Zaria. 243 – 252.
- Diugwu, I. A., Baba, D. L., & Egila, A. E. (2012) Effective regulation and level of awareness: An expose of the Nigeria's construction industry. *Open Journal of Safety Science and Technology*, 2:140-146
- El-Mashaleh, M. S., Rababeh, S. M., & Hyari, K. H. (2010). Utilizing data envelopment analysis to the benchmark safety performance of construction contractors. *International Journal of Project Management*, 28(1), pp.61-67.
- Enhassi, G., Akinwale A. A., & Olusanya O. A. (2015). "Implications of occupational health and safety intelligence in Nigeria," *Journal of Global Health Care Systems*, 6(1), pp.1-13, 2016. [www.jghcs.info](http://www.jghcs.info)
- Eyiah, A. (2004). Regulation and small contractor development: A case of Ghana. Centre on Regulation and Competition, Institute for Development Policy and Management, University of Manchester, Manchester, Working Paper.
- Ghousi, R., Khanzadi, M., & Mohammad, A. K. (2018). A Flexible Method of Building Construction Safety Risk Assessment and Investigating Financial Aspects of Safety Program. *International Journal of Optimization in Civil Engineering*. 8(3):433-452
- Gurcanli, G. E., Bilir, S. M., & Sevim, M. (2015). Activity based risk assessment and safety cost estimation for residential building construction projects, *Safety Science*, Elsevier, 80: 1-12
- Idubor, E. E., & Oisamoje, M. D. (2013) Management issues in Nigeria's effort to industrialize. *European Scientific Journal*, 3(12), pp. 92-104.
- Ikpe, E. O. (2010). Development of cost benefit analysis model of accident prevention on construction projects (PhD). University of Wolverhampton, Wolverhampton
- Jackman, M., (2010). Investigating the relationship between residential construction and economic growth in a small developing country: The case of Barbados. *International real estate review*
- Jannadi, O.A. & Bu-Khamsin, M.S., (2002). Safety factors considered by industrial contractors in Saudi Arabia. *Building Environment*, 37(5), pp.539-47. [https://doi.org/10.1016/S0360-1323\(01\)00056-7](https://doi.org/10.1016/S0360-1323(01)00056-7).
- Koehn, E, Kothari, R. K., & Pan, C. (2013). Safety in developing countries: professional and bureaucratic problems, *Journal of Construction Engineering and Management*, 121 (3), 261– 265

- Lingard, H., Pink, S., Harley, J., & Edirisinghe, R. (2015). Looking and learning: using participatory video to improve health and safety in the construction industry. *Construction Management and Economics*, 33(9), pp.740–51.
- Mbuya, E., & Lema, N. M (2002) Towards Development of a Framework for Integration of Safety and Quality Management Techniques in Construction Project Delivery Process. Proceedings of the First International Conference of CIBW107–Creating a Sustainable Construction in Developing Countries, 11-13 November, McGraw-Hill, New York
- Misan, M. S., Yusof, Z. M., Mohamed, S.F., & Othman, N. (2012). Safety Cost in Construction Projects. The 3rd International Conference on Construction Industry. Padang-Indonesia, April 10-11th 201
- Muiruri, G. & Mulinge, C. (2014). Health and Safety on construction project sites in Nairobi. *International Journal of Business, Humanities and Technology*, 2(2)
- National Bureau of Statistics (2012) Nigerian construction sector: summary report 2010-2012 Abuja: National Bureau of Statistics. Available online at <http://www.nigeriastat.gov.ng/nbslibrary/sctor-statistics> (Access 01/04/2019).
- National Bureau of Statistics and the Small & Medium Enterprises Development Agency of Nigeria (2012). A Survey Report on Micro, Small & Medium Enterprises in Nigeria (NSME); Preliminary Report.2010 National NSME Collaborative Survey. National Bureau of Statistics and the Small & Medium Enterprises Development. Agency of Nigeria. May, 2012.
- Nzuve, S. N. M., & Lawrence, B. A. (2012). The extent of compliance with Occupational safety and health regulations at registered workplaces in Nairobi. *International Journal of Business, Humanities and Technology*, 2(2), 115-120
- Okojie, O. (2010). Systems for reporting Occupational diseases in Nigeria. *Africa newsletter on occupational health and safety*
- Phoya, S. (2012). Health and safety risk management on building construction sites in Tanzania: the practice of risk assessment, communication and control. An unpublished master thesis submitted to Chalmers University of Technology
- Popov, G., Lyon, B.K., & Hollcroft, B. (2016). Risk assessment: A practical guide to assessing operational risks, 1st ed. Australia: Wiley.
- Sherratt, F., Crapper, M., Foster-Smith, L., & Walsh, S. (2015). Safety and volunteer construction workers. *Construction Management and Economics*, 33(5-6), pp.361-74.
- Shittu, A. A., Ibrahim, A. D., Ibrahim, Y. M., & Adogbo, K. J. (2015a). Assessment of Level of Implementation of Health and Safety Requirements in Construction Projects Executed by Small Firms in Abuja. In D. R. Ogunsemi, O. A. Awodele and A. E. Oke (Eds). Proceedings of the 2nd Nigerian Institute of Quantity Surveyors Research Conference. Federal University of Technology, Akure. 1st– 3rd September. 467 – 482.
- Shittu, A. A., Ibrahim, A. D., Ibrahim, Y. M., & Adogbo, K. J. (2015b). Impact of Demographic Features on Health and Safety Practices of Construction Contractors in Abuja, Nigeria. In A. Nasir, A. S. Abdurrahman and A. S. Kovo (Eds). Procs: 1st International Engineering Conference (IEC 2015). School of Engineering and Engineering Technology, Federal University of Technology, Minna, Nigeria. 1st – 3rd September. 31 – 46.

- Shittu, A. A., Ibrahim, A. D., Ibrahim, Y. M., Adogbo, K. J., & Mac-Barango, D. O. (2016). Impact of Organisational characteristics on health and safety practices of construction contractors. *Nigerian Journal of Technological Research (NJTR)*. Federal University of Technology, Minna, Nigeria. 11(1), 60 – 67.
- Smallwood, J. J. (2010). The image of contractors: a South African case study, in: Leeds, UK, Association of Researchers in Construction Management, pp.939- 946.
- Umeokafor, I., Jones, K.G., & Umeadi, B. (2014) "Enforcement of occupational safety and health regulations in Nigeria: An exploration, "European Scientific Journal, Special Edition", 3, pp.93-104.
- World Bank (2016).Gross domestic product ranking table 2014 Washington: World Bank. Available at <http://data/download/GDP.pdf> (Accessed 01/06/2018)
- Zhou, P.X.W., & Sunindijo, R.Y. (2015). Strategic Safety Management in Construction and Engineering.





# AUTOMATED RECOGNITION OF CONSTRUCTION WORKERS' PHYSICAL FATIGUE BASED ON FOOT PLANTAR PATTERNS CAPTURED FROM A WEARABLE INSOLE PRESSURE SYSTEM

Maxwell Fordjour Antwi-Afari<sup>1</sup>, Heng Li<sup>2</sup>, David John Webb<sup>3</sup>, Shahnawaz Anwer<sup>4</sup>, JoonOh Seo<sup>5</sup>, Kenneth Sungho Park<sup>6</sup> and Alex Torku<sup>7</sup>

<sup>1,6</sup>*Department of Civil Engineering, College of Engineering and Physical Sciences, Aston University, B4 7ET, Birmingham, United Kingdom,*

<sup>2,4,5,7</sup>*Department of Building and Real Estate, Faculty of Construction and Environment, The Hong Kong Polytechnic University, Kowloon, Hong Kong Special Administrative Region (SAR).*

<sup>3</sup>*Aston Institute for Urban Technology and the Environment (ASTUTE), Aston University, B4 7ET, Birmingham, United Kingdom.*

Construction workers are exposed to numerous non-fatal occupational injuries (e.g., fall accidents, work-related musculoskeletal disorders) due to physically demanding activities such as repetitive lifting tasks. One of the key preventive measures to mitigate these occupational injuries among construction workers is by recognizing workers' physical fatigue. However, previous approaches for recognizing workers' fatigue are subjective, time-consuming, and based on localized muscle fatigue. Therefore, the objective of this study is to develop a non-invasive approach to recognize workers' physical fatigue by capturing foot plantar patterns measured by a wearable insole pressure system after a fatiguing repetitive lifting task. The experimental protocol was designed to recruit construction workers to participate in this study by collecting their foot plantar patterns during normal gait and after a fatiguing repetitive lifting task. The performance accuracy was evaluated by adopting five types of supervised machine learning classifiers and different window sizes. The results showed that the Random Forest classifier obtained the best classification performance with an accuracy of 95.8% and sensitivity of 97.8% using a sliding window of 2.56s. The findings indicate that the proposed approach would provide useful ergonomic intervention guidelines for early detection of workers' physical fatigue, and thus enable safety managers to mitigate non-fatal occupational injuries among construction workers.

Keywords: construction workers, physical fatigue, repetitive lifting task, supervised machine learning classifiers, wearable insole pressure system, work-related musculoskeletal disorders

---

<sup>1</sup> m.antwifari@aston.ac.uk

<sup>2</sup> heng.li@polyu.edu.hk

<sup>3</sup> d.j.webb@aston.ac.uk

<sup>4</sup> shahnawaz.anwer@connect.polyu.hk

<sup>5</sup> joonoh.seo@polyu.edu.hk

<sup>6</sup> k.park@aston.ac.uk

<sup>7</sup> alex.torku@connect.polyu.hk

## **INTRODUCTION**

Studies have shown that the construction industry is one of the most hazardous workplaces and unsafe industries worldwide with numerous non-fatal occupational injuries (Seo et al., 2016; Scott et al., 2018). For example, in the United States, the construction industry reported more than 970 fatal and 200,000 non-fatal incidents in 2017 (Bureau of Labor Statistics, 2018). It has also been reported that 309,060 cases of injuries in the construction industry were caused by falls (Scott et al., 2018). Despite significant research efforts that suggested several preventive measures for mitigating workers' injuries, the rate of non-fatal occupational injuries remains prevalent. Consequently, there is still a critical need to improve workers' safety.

Construction workplace activities (e.g., lifting, carrying, pulling, pushing) are usually dynamic, physically demanding, repetitive, and often conducted manually for prolonged work duration under harsh environmental conditions without sufficient rest duration (Antwi-Afari et al., 2017b). These work-related risk factors are likely to expose workers to a high risk of developing physical fatigue. It is widely known that prolonged conditions of workers' physical fatigue could lead to occupational issues such as work-related musculoskeletal disorders (WMSDs) and non-fatal fall accidents (Looze et al., 2009; BLS, 2018).

Previous studies on assessing workers' physical fatigue are mainly based on self-reported methods such as questionnaires. These manual methods rely on reporting subjective fatigue levels (Debnath et al., 2015; Zhang et al., 2015). To address these limitations in the traditional approaches, there has been an increasing number of studies that utilized biomechanical analysis methods (e.g., kinetics and kinematics) and electrical physiological signals such as heart rate, heart-rate variability, skin temperature, surface electromyography, electrodermal activity (Gatti et al., 2014; Romanovsky, 2014; Antwi-Afari et al., 2017b). Despite being useful and providing accurate results for fatigue monitoring, wearing these sensors in different bodily locations make workers feel uncomfortable, and they also have high hardware costs—limiting their applications on construction sites (Zhang et al. 2018).

Therefore, this research study aims to develop a non-invasive and automated recognition of workers' physical fatigue by using foot plantar patterns captured by a wearable insole pressure system. Field experiments were designed and conducted to collect workers' fatigued patterns after a fatiguing repetitive lifting task. Supervised machine learning classifiers were adopted to train and classify normal gait and physically fatigued patterns. Overall, the findings of this study could aid in the early detection of workers' physical fatigue, which will improve construction workers' safety and productivity.

## **LITERATURE REVIEW**

Fatigue is defined as a decline in an individual's ability to perform a given task at a desirable level of performance (Hallowell, 2010). Fatigue can be classified into three main groups, namely: physical fatigue, mental fatigue, and emotional fatigue. Numerous studies focused on the detection of workers' emotional and mental fatigue states in construction (Hwang et al., 2018; Jebelli et al., 2018; Xing et al., 2019). Unlike mental and emotional fatigue states (e.g., anxiety, stress), physical



fatigue is particularly characterized as a reduction of an individual ability to perform a physical task resulting from physical exertion or demand (Sharpe, 1991).

There are several methods to assess whole-body physical fatigue. Several decades ago, one of the traditional methods for assessing workers' physical fatigue in the workplace was by using self-reported methods (Debnath et al., 2015; Zhang et al., 2015). Examples of these methods include the Borg's Rating of Perceived Exertion-scale (RPE), Borg's Category Ratio-scale (Borg CR-10), Need for Recovery Scale (NRS), and Fatigue Assessment Scale (Borg, 1998; Van Veldhoven, 2003). Although they are easy to implement, self-reported methods depend on workers' subjective perceptions and consequently are biased.

Biomechanical models, which analyze human movements and estimate joint loadings, are another method to assess workers' physical fatigue (Seo et al., 2016). To estimate internal tissue loadings, electromyography-assisted biomechanical models and remote-sensing approaches have been demonstrated in previous studies (Neumann et al., 2001; Seo et al., 2016). Biomechanical models have the potential for processing human motion data to assess workers' physical fatigue but require large sample data, and errors are easily caused by the configuration of the biomechanical skeleton models (Wang et al., 2015a).

Other measurement indicators for assessing workers' physical fatigue are physiological parameters such as surface electromyography (sEMG), electrodermal activity (EDA), electroencephalography (EEG), heart rate (HR), heart rate variability (HRV), and skin temperature (ST) (Antwi-Afari et al., 2017b; Sumowski and Leavitt, 2014; Aryal et al., 2017; Jebelli et al., 2018; Xing et al., 2019). These physiological parameters are usually measured by using different types of wearable biosensors (e.g., headsets, chest straps, and wristbands). Although they provide useful findings for assessing workers' physical fatigue, collecting physiological parameters is challenging due to intrinsic artifacts such as facial muscle movement (Jebelli et al., 2020).

Vision-based motion capture methods such as Depth cameras and RGB images provide non-invasive approaches to assessing workers' physical fatigue. Previous studies have demonstrated that vision-based approaches are effective to collect workers' motion data in both indoor and outdoor environments (Ray and Teizer, 2012; Yu et al., 2019). While these approaches are highly accurate, vision-based motion capture methods are limited because they do not allow continuous monitoring outside laboratory environments.

With the recent advancement of wearable sensing techniques, wearable inertial measurement units (WIMUs) have been widely used to obtain construction workers' bodily responses or gait patterns for improving occupational safety (Jebelli et al., 2015; Yang et al., 2017; Conforti et al., 2020). In spite of their usefulness, WIMUs not only require sensors to be attached to the workers' skin which may cause discomfort but also require additional attachments such as straps or belts to prevent detachment of sensors from the body when performing tasks.

Given the above limitations, this research proposes a noninvasive and automated recognition of workers' physical fatigue by using foot plantar patterns measured by a wearable insole pressure system. It can be easily inserted or detached from

workers' safety boots, which minimizes restraint in body movement and discomfort (Antwi-Afari and Li 2018g). In addition, it offers higher portability, ease of use, and great potential in complex and dynamic applications without being invasive as compared to other traditional approaches.

## **RESEARCH METHODS**

### **Participants**

Three asymptomatic male construction workers were voluntarily recruited to participate in this study. Their mean age, weight, and height were  $38.4 \pm 3.21$  years,  $74 \pm 2.34$  kg, and  $1.72 \pm 0.06$  m, respectively. The participants had no medical history of mechanical upper extremities or back pain, or lower extremity injuries. Participants provided their informed consent in accordance with the approved procedure.

### **Experimental procedure and data collection**

An OpenGo system (Moticon SCIENCE Sensor Insole GmbH, Munich, Germany), which consists of 16 capacitive pressure sensors, a 3-axis gyroscope (MEMS LSM6DSL, ST Microelectronics), and a 3-axis accelerometer for each sensor insole was used for data collection. Pressure sensors have a range, resolution, and hysteresis of 0 to 50.0 N/cm<sup>2</sup>, 0.25 N/cm<sup>2</sup>, and  $\leq 1\%$ , respectively.

A cross-sectional study design was adopted during a single visit. All participants were asked to wear personal protective equipment such as a pair of safety boots and a hard hat during the testing sessions. During data acquisition, the experimenter used Borg's Rating of Perceived Exertion (RPE) (Borg, 1998) to collect the participants' perceived level of physical fatigue for every 10 minutes. The RPE scale is a simple and subjective rating scale, from 6 to 20, with descriptions ranging from "No physical exertion at all" to "Maximal exertion", respectively. Based on previous ergonomics studies, the Borg-20 scale is a reliable method for monitoring physical demands during repetitive lifting task tasks and it has been reported that participants physical fatigue occurred when RPE was  $\geq 15$  (Nasirzadeh et al., 2020).

The designed experimental tasks involved a normal gait and physically fatigued patterns collected after repetitive lifting tasks on a construction site. Notably, a prolonged repetitive lifting task that involves physical exertion without a rest period has been identified as the leading risk factor for developing WMSDs and physical fatigue among construction workers (BLS, 2016). The entire experiment was recorded using a video camcorder.

### **Data segmentation**

A sliding window technique was adopted to divide foot plantar patterns into smaller segments, each segment containing a specified number of data samples (Preece et al., 2009). The sampling frequency selected was 50 Hz, which implies that for every second, 50 data samples are obtained. Window sizes of 0.32s, 0.64s, 1.28s, and 2.56s were used because the conversion of the time domain to frequency domain using fast Fourier transform (FFT) in MATLAB 9.2 software (Matlab, The MathWorks Inc., MA, USA) required the window size to be a power of 2 (Akhavian and Behzadan, 2016). To prevent missing relevant data, an overlapping of

consecutive windows was conducted. A 50% overlap of adjacent data segment lengths was used as demonstrated in previous studies (Antwi-Afari et al., 2018c).

### **Feature extraction**

Relevant features were extracted from the pre-processed segmented data based on distinctive characteristics such as sensor signal streams and signal frequency. Given the segmented data samples, feature extraction methods were divided into three categories, namely time-domain, frequency-domain, and spatio-temporal features. In the initial stage, time-domain features, also known as signal statistical features, were extracted, such as mean, variance, maximum, minimum, interquartile range, standard deviation, root mean square, kurtosis, and skewness. Next, plantar pressure data in the time-domain was converted to the frequency-domain by using the fast Fourier transform (FFT) in MATLAB 9.2 software (Matlab, The MathWorks Inc., MA, USA). Frequency-domain features are extracted based on the frequency variations of pressure signals over time. Two frequency-domain features, namely spectral energy and entropy spectrum were extracted. Lastly, three spatiotemporal features, including pressure-time integral, anterior/posterior center of pressure, and medial/lateral center of pressure were also extracted. Spatiotemporal features were extracted based on both space and time variations of pressure signals over time.

### **Reference data**

After feature extraction, a class label was manually assigned to each window with the aid of video recordings. The purpose of reference data in human activity recognition studies is to provide a ground truth to evaluate the performance of supervised machine learning classifiers (Akhavian and Behzadan, 2016; Antwi-Afari et al., 2020a). It also ensures that the collected plantar patterns could correctly represent actual experimental tasks.

### **Classifier training**

During the classifier training, all extracted features (input variables) were trained using a supervised machine learning classifier to classify normal gait and physical fatigue gait patterns (output variables). Many supervised machine learning classifiers have been applied in human activity recognition and fall risk detection (Akhavian and Behzadan, 2016; Antwi-Afari et al., 2018c; Antwi-Afari et al., 2020a). Nevertheless, in this study, five different types of supervised machine learning classifiers were examined, namely: (1) Artificial Neural Network (ANN); (2) Decision Tree (DT); (3) Random Forest (RF); (4) K-Nearest Neighbor (KNN); and (5) Support Vector Machine (SVM). All data processing of the classifiers were performed using Toolbox in MATLAB 9.2 software.

### **Model assessment and performance evaluation**

During the training process, a 10-fold cross-validation was used to assess the accuracy and validity of the classifier models (Attal et al., 2015). Lastly, the performance of the supervised classifiers was assessed by using metrics such as accuracy and sensitivity (Attal et al. 2015). Equations 1 and 2 show how each metric is calculated.

$$Accuracy = \frac{TP + TN}{TP + TN + FP + FN} \quad (1)$$

$$Sensitivity = \frac{TP}{TP + FN} \quad (2)$$

Where, True Positive (TP) is the number of positive instances that were classified as positive; True Negative (TN) is the number of negative instances that were classified as negative; False Positive (FP) is the number of negative instances that were classified as positive; and False Negatives (FN) is the number of positive instances that were classified as negative.

## RESULTS AND DISCUSSION

Table 1 illustrates the classification accuracy of using the individualized data of each participant. As shown in Table 1, the RF classifier had the best accuracy as compared to other classifiers. This result indicates that the RF classifier shows the best performance for recognizing fatigue patterns after a fatiguing repetitive lifting task. Regarding different types of window segments, the 2.56s window size provided the highest accuracies among all classifiers. Among the different classifiers, the RF classifier achieved the highest accuracies at the 2.56s window size. In addition, participant III obtained the highest accuracy (i.e., 95.8%) at 2.56s window size, followed by participant II (i.e., 94.5%) and participant I (i.e., 93.8%). These results suggest that larger window sizes of fatigued patterns provide better performance than smaller window sizes.

**Table 1. Classification accuracy (%) for each participant**

Window size		ANN	DT	KNN	SVM	RF
0.32s	Participant I	53.4	63.5	71.3	74.6	82.4
	Participant II	54.8	61.7	73.7	75.3	81.8
	Participant III	55.5	66.8	76.2	77.4	83.4
0.64s	Participant I	62.5	68.9	77.3	79.5	84.8
	Participant II	61.3	63.9	71.6	78.6	81.6
	Participant III	65.8	70.4	78.3	80.5	85.6
1.28s	Participant I	67.8	72.3	80.1	82.8	88.2
	Participant II	69.3	74.1	82.2	84.7	90.2
	Participant III	70.8	75.4	85.6	87.4	92.1
2.56s	Participant I	72.4	77.8	86.3	91.4	93.8
	Participant II	74.7	78.4	88.4	92.1	94.5
	Participant III	75.8	80.2	90.5	94.8	95.8

Fig. 1a, 1b, and 1c show the confusion matrices of the best classifier (i.e., RF classifier) at 2.56s window size for each participant. The sensitivity of fatigued patterns was higher than normal gait as captured by a wearable insole pressure system. The results showed that the sensitivity of fatigued patterns for participants

I, II, and III were 95.8%, 96.5%, and 97.8%, respectively. The findings of these results indicate that fatigued patterns as captured by a wearable insole pressure system were positively recognized after performing a fatiguing repetitive lifting task.

The implications of the findings are very promising because this is the first study to collect foot plantar patterns from construction workers on a real-world construction site. Since the results reported a high accuracy of workers 'physical fatigue from plantar patterns, the proposed approach could be adopted by safety managers as useful ergonomic guidelines for preventing workers 'physical fatigue and WMSDs.

	1	92.5%	7.5%
True class	2	4.2%	95.8%
		1	2

Predicted class

(a) Participant I

	1	94.6%	5.4%
True class	2	3.5%	96.5%
		1	2

Predicted class

(b) Participant II

	1	95.4%	4.6%
True class	2	2.2%	97.8%
		1	2

Predicted class

(c) Participant III

Fig. 1. Confusion matrix of the RF classifier for each participant at a window size of 2.56s: (a) Participant I; (b) Participant II; and (c) Participant III

## CONCLUSIONS

The current study examined the use of foot plantar patterns captured by a wearable insole pressure system for automated recognition of workers 'physical fatigue. The experimental study was conducted by three construction workers to recognize and classify physical fatigued patterns measured by a wearable insole pressure system. It was reported that the RF classifier with 2.56s window size obtained the best classification accuracy of 93.8%, 94.5%, and 95.8% for participants I, II, and III, respectively. In addition, the sensitivity of fatigued patterns as compared to normal gait were 95.8% (PI), 96.5% (PII), and 97.8% (PIII). The implications of these findings indicate that foot plantar patterns captured by using a wearable insole pressure

system offer a plausible method for recognizing fatigued patterns after a fatiguing repetitive lifting task. As such, safety managers could use the proposed approach as a wearable sensing technology for detecting workers 'physical fatigue, which could help to prevent WMSDs and improve workers 'productivity. The main contribution of the study is that researchers and construction practitioners could use the proposed approach for early recognition of workers 'fatigue, thus preventing safety issues on construction sites. Despite these useful findings, there are few limitations to this study. First, the experiments were only conducted on three workers on site after a fatiguing repetitive lifting task. Second, the collected fatigued patterns were trained using supervised machine learning classifiers. Future studies should be conducted to compare the results by using larger samples of construction workers, different workplace activities, and other deep learning networks.

## **ACKNOWLEDGEMENT**

The authors acknowledged support from Aston Institute for Urban Technology and the Environment (ASTUTE), Seedcorn Grants Proposal entitled "Wearable Insole Sensor Data and a Deep Learning Network-Based Recognition for Musculoskeletal Disorders Prevention in Construction". Special thanks to all our participants involved in this study.

## **REFERENCES**

- Akhavian, R., & Behzadan, A. H., (2016). Smartphone-based construction workers' activity recognition and classification. *Automation in Construction*, 71(2), pp. 198-209.
- Antwi-Afari, M. F., & Li, H., (2018g). Fall risk assessment of construction workers based on biomechanical gait stability parameters using wearable insole pressure system. *Advanced Engineering Informatics*, 38, pp. 683-694.
- Antwi-Afari, M. F., Li, H., Edwards, D. J., Pärn, E. A., Seo, J., & Wong, A. Y. L., (2017b). Biomechanical analysis of risk factors for work-related musculoskeletal disorders during repetitive lifting task in construction workers. *Automation in Construction*, 83, pp. 41-47.
- Antwi-Afari, M. F., Li, H., Seo, J., Lee, S., Edwards, D. J., & Wong, A. Y. L., (2018c). Wearable insole pressure sensors for automated detection and classification of slip-trip-loss-of-balance events in construction workers. *Construction Research Congress 2018*, New Orleans, Louisiana, USA, Reston, VA: ASCE, April 2-5, 2018.
- Antwi-Afari, M. F., Li, H., Umer, W., Yu, Y., & Xing, X., (2020a). Construction activity recognition and ergonomic risk assessment using a wearable insole pressure system. *Journal of Construction Engineering and Management*. 146(7), pp. 04020077.
- Aryal, A., Ghahramani, A., & Becerik-Gerber, B. (2017). Monitoring fatigue in construction workers using physiological measurements. *Automation in Construction*, 82, pp. 154-165.
- Attal, F., Mohammed, S., Dedabrishvili, M., Chamroukhi, F., Oukhellou, L., & Amirat, Y., (2015). Physical human activity recognition using wearable sensors. *Sensors*, 15(12), pp. 31314-31338.

- Borg, G. A. (1998). Borg's Perceived Exertion and Pain Scales. Human Kinetics, Champaign, IL.
- Bureau of Labor Statistics. (2016). Nonfatal occupational injuries and illnesses requiring days away from work. <http://www.bls.gov/news.release/pdf/osh2.pdf>.
- Bureau of Labor Statistics. (2018). Injuries, illnesses, and fatalities. <https://www.bls.gov/iif/>.
- Conforti, I., Mileti, I., Del Prete, Z. and Palermo, E., 2020. Measuring biomechanical risk in lifting load tasks through wearable system and machine-learning approach. *Sensors*, 20(6), pp. 1557.
- Debnath, A. K., Blackman, R., & Haworth, N., (2015). Common hazards and their mitigating measures in work zones: A qualitative study of worker perceptions. *Safety Science*, 72, pp. 293–301.
- Gatti, U. C., Schneider, S., & Migliaccio, G. C. (2014). Physiological condition monitoring of construction workers, *Automation in Construction*, 44, pp. 227–233.
- Hallowell, M. R. (2010). Worker fatigue. *Professional Safety*, 55(12), pp. 18–26.
- Hwang, S., Jebelli, H., Choi, B., Choi, M., & Lee, S. (2018). Measuring workers' emotional state during construction tasks using wearable EEG. *Journal of Construction Engineering and Management*, 144(7), pp. 04018050.
- Jebelli, H., Ahn, C. R., & Stentz, T. L. (2015). Comprehensive fall-risk assessment of construction workers using inertial measurement units: validation of the gait-stability metric to assess the fall risk of iron workers. *Journal of Computing in Civil Engineering*, 30(3), pp. 04015034.
- Jebelli, H., Hwang, S., & Lee, S. (2018). EEG-based workers 'stress recognition at construction sites. *Automation in Construction*, 93, pp 315–324.
- Jebelli, H., Seo, J., Hwang, S., & Lee, S. (2020). Physiology-based dynamic muscle fatigue model for upper limbs during construction tasks. *International Journal of Industrial Ergonomics*, 78, pp. 102984.
- Looze, M. D., Bosch, T., & Dieen, J. V. (2009). Manifestations of shoulder fatigue in prolonged activities involving low-force contractions. *Ergonomics*, 52(4), pp. 428e437.
- Nasirzadeh, F., Mir, M., Hussain, S., Tayarani Darbandy, M., Khosravi, A., Nahavandi, S., & Aisbett, B. (2020). Physical fatigue detection using entropy analysis of heart rate signals. *Sustainability*, 12(7), pp. 2714.
- Neumann, W. P., Wells, R. P., Norman, R. W., Frank, J., Shannon, H., & Kerr, M. S., (2001). A posture and load sampling approach to determining low-back pain risk in occupational settings. *International Journal of Industrial Ergonomics*, 27, pp. 65–77.
- Preece, S. J., Goulermas, J. Y., Kenney, L. P., Howard, D., Meijer, K., & Crompton, R. (2009). Activity identification using body-mounted sensors—a review of classification techniques. *Physiological Measurement*, 30(4), pp. R1–R33.
- Ray, S. J., & Teizer, J. (2012). Real-time construction worker posture analysis for ergonomics training. *Advanced Engineering Informatics*, 26, pp. 439–455.
- Romanovsky, A. A. (2014). Skin temperature: Its role in thermoregulation. *Acta Physiologica*, 210(3), pp. 498–507.
- Scott, K. A., Fisher, G. G., Baron, A. E., Tompa, E., Stallones L., & DiGuseppi, C., (2018). Same-level fall injuries in US workplaces by age group, gender, and industry. *American journal of industrial medicine*, 61(2), pp. 111-119.

- Seo, J., Lee, S., & Seo, J. (2016). Simulation-based assessment of workers 'muscle fatigue and its impact on construction operations. *Journal of Construction Engineering and Management*, 142(11), pp. 04016063.
- Sharpe, M. C. (1991). A report-chronic fatigue syndrome: guidelines for research. *Journal of the Royal Society of Medicine*, 84(2), pp. 118-121.
- Sumowski, J. F., & Leavitt, V. M. (2014). Body temperature is elevated and linked to fatigue in relapsing-remitting multiple sclerosis, even without heat exposure. *Archives of Physical Medicine and Rehabilitation*, 95(7), pp. 1298–1302.
- van Veldhoven, M. (2003). Measurement quality and validity of the "need for recovery scale. *Occupational and Environmental Medicine*, 60, pp. 3i–9.
- Wang, D., Dai, F., & Ning, X. (2015a). Risk assessment of work-related musculoskeletal disorders in construction: state-of-the-art review. *Journal of Construction Engineering and Management*, 141(6), pp. 1–15.
- Xing, X., Li, H., Li, J., Zhong, B., Luo, H., & Skitmore, M. (2019). A multicomponent and neurophysiological intervention for the emotional and mental states of high-altitude construction workers. *Automation in Construction*, 105, pp. 102836.
- Yang, K., Ahn, C. R., Vuran, M. C., & Kim, H. (2017). Collective sensing of workers 'gait patterns to identify fall hazards in construction. *Automation in Construction*, 82, pp. 166–178.
- Yu, Y., Li, H., Umer, W., Dong, C., Yang, X., Skitmore, M., & Wong, A. Y. L. (2019). Automatic biomechanical workload estimation for construction workers by computer vision and smart insoles, *Journal of Computing in Civil Engineering*, 33, pp. 04019010.
- Zhang, L., Diraneyya, M. M., Ryu, J., Haas, C. T., & Abdel-Rahman, E. (2018). Assessment of jerk as a method of physical fatigue detection. In *ASME 2018 International Design Engineering Technical Conferences and Computers and Information in Engineering Conference*. American Society of Mechanical Engineers Digital Collection.
- Zhang, M., Sparer, E. H., Murphy, L. A., Dennerlein, J. T., Fang, D., Katz, J. N. , & Caban-Martinez, A. J. (2015). Development and validation of a fatigue assessment scale for U.S. construction workers. *American Journal of Industrial Medicine*, 58 (2), pp. 220–228.





---

# AWARENESS AND ACCEPTANCE OF SMART SECURITY SYSTEM AMONG OCCUPANTS OF SELECTED PUBLIC BUILDINGS IN CENTRAL BUSINESS DISTRICT (FCT-ABUJA) NIGERIA

**Fatima Baba Ciroma<sup>1</sup>, Musa Lawal Sagada<sup>2</sup> and Joy Joshua Maina<sup>3</sup>**

<sup>1,2,3</sup>*Department of Architecture, Faculty of Environmental Studies, Ahmadu Bello University, Zaria, Nigeria*

Considering the persistence increase of burglary and fire incidences, coupled with lack of effective security systems (lock-and-key) in public buildings in Nigeria, there has been a clamor for an innovative and creative system like Smart Security Systems that can be deployed against all forms of intruders and related security challenges. This paper investigated the awareness, and acceptance of smart security system among occupants of selected public buildings in Nigeria with the Central Business District (CBD) FCT-Abuja as the area of study. Also, a gap exists in literature on a formal scientific approach to the analysis and evaluation of behavioral changes that will occur in public buildings in Nigeria in the context of smart security systems. To address this gap and present a formal analysis, this study adopted a cross-sectional survey research design with a quantitative approach to data collection using the study's population of 253 occupants of selected public buildings within the Central Business District (CBD) FCT-Abuja; out of which 153 occupants were randomly selected. The validated Smart Security System Questionnaire (SSSQ) was used as data collection instrument. 132 representing out of 153 copies of SSSQ were analyzed using frequency, percentage, mean, standard deviation in tabulation format; these values were subjected to ANOVA evaluation in order to determine the strong and weak data components. These statistics which were scientifically computed with the aid of Statistical Packages for Social Sciences (SPSS) at 0.05 (p-value) is a true test of statistical significance. Findings from the study reveal that while the occupants of public buildings believe that a smart security system will make their offices more secure, the expected level of acceptance to the operation of their workplace as a result of changes that will occur due to the incorporation of a smart security system has not been observed. It was also found that the management and occupants of selected public buildings in Central Business District (CBD) FCT-Abuja are quite aware of Smart Security System as security mechanism; they showed an appreciable level to accept, deploy and implement the system in their building architecture. The one-way ANOVA test performed revealed significant statistical difference between group means for readiness level and perceived usefulness for smart security systems.

Keywords: acceptance, awareness, knowledge, perceived usefulness, smart security system

---

<sup>1</sup> ciromafb@gmail.com

<sup>2</sup> msagada2010@gmail.com

<sup>3</sup> jjmaina@abu.edu.ng

## INTRODUCTION

Insecurity is a global phenomenon. Insecurity is a global problem that requires urgent attention from government and stakeholders worldwide, it has become rampant globally but in Nigeria it has escalated to an un-presidential level.

The idea of smart security system in buildings- especially public buildings is an active and evolving area of research among Architects, and other designers of public buildings (Al-Humairi & Kamal, 2021; Ciholas et al., 2019; SARHAN, 2020; To et al., 2018). The rapidly advancing frontiers of technology- especially communication and surveillance technologies with the corresponding increase in the sophistication and nature of crimes have made it very imperative for public buildings to be properly equipped with smart security system. This is more so important as smart building security systems give an enhanced sense of security for the occupants while at the same time being environment-friendly and power efficient (Kupchik, 2010).

In the west, smart security systems in public buildings is a notion that has long been adopted as a necessary part of infrastructure the buildings represent. The high level of education and technological advancement in the west have been largely responsible for this. The case is however different in developing countries, where poor infrastructural designs and weak economies have been inhibiting factors in the adoption of smart security systems in public buildings; other contributing factors include low quality of education, and the lack of a formal study focused on the local reality of the environment in which the buildings are found.

Nigeria, being a developing country is not exempted from this reality. To the best of our knowledge, there are only few papers in literature on the formal scientific analysis of the level of awareness of smart security systems in public buildings in Nigeria. As a result of this, papers investigating the level of awareness of smart security systems in public buildings are rare in the Nigerian context especially in Abuja.

This study investigates the level of awareness about smart security system; enthusiasm level towards use of smart security system; perceived usefulness of using smart security system; and attitude of occupants of selected public buildings towards using smart security system in Central Business District (CBD) FCT-Abuja, Nigeria. To realize these objectives, the paper focuses on the following questions:

- What is the level of awareness about smart security system among occupants of selected public buildings in Central Business District (CBD) FCT-Abuja?
- What is the perceived usefulness of using smart security system by occupants of selected public buildings in Central Business District (CBD) FCT-Abuja?
- What is the attitude of occupants of selected public buildings towards using smart security system in Central Business District (CBD) FCT-Abuja?

## LITERATURE REVIEW

This section presents the review of studies that are found related to the smart security system. It should be noted that the empirical analysis of the existing studies is presented in chronological order.

In the UK, (Wilson et al., 2017) examined the perceived benefits and risks of smart security systems as it applies to homes and public buildings, from multiple perspectives. Results show that national survey representatives of UK homeowners (n=1025) find prospective users have positive perceptions of the multiple functionalities of smart security systems including energy management. Ceding autonomy and independence in the home for increased technological control are found as the main perceived risks. An additional survey with (n=42) participating in a smart home field trial identifies the key role of early adopters in lowering perceived smart security systems risks for the mass market. Content analysis of smart security systems marketing material (n=62) shows that the smart security systems industry is insufficiently emphasizing measures to build consumer confidence in Data security and privacy.

In China, (Hsu et al., 2017) developed a multisensory data fusion technology-based smart home system by integrating wearable intelligent technology, artificial intelligence, and sensor fusion technology. An experimental testbed for validating the effectiveness and feasibility of the smart home system was built and verified experimentally. The results showed that the 3D gesture recognition algorithm could achieve recognition rates for automated household appliance control of 92.0%, 94.8%, 95.3%, and 87.7% by the 2-fold cross-validation, 5-fold cross-validation, 10-fold cross-validation, and leave-one-subject-out cross-validation strategies. For indoor positioning and smart energy management, the distance accuracy and positioning accuracies were around 0.22% and 3.36% of the total traveled distance in the indoor environment. For home safety and fire detection, the classification rate achieved 98.81% accuracy for determining the conditions of the indoor living environment.

In Nigeria, (Olarewaju et al., 2017) designed and constructed an automatic home security system based on GSM technology and an embedded microcontroller unit. The system consisted of an infrared motion detector and a magnetic sensor as transducers for detecting intruders motion or break in through a door. The signals are then processed by an embedded microcontroller unit which then activates the GSM module and sends SMS message to the householder's mobile phone device, an at the same time activating an attached alarm system. Initial testing of this system shows that it worked as expected. The developed GSM based security system gives a good response to the sensor and sends SMS when it detects intrusion at the windows or indoor. The test result shows that both the braking switches attached to the door hinges and the motion sensors perform adequately as expected.

Being an active area of research, the concept of smart security in public buildings is still attracting a lot of interest from the research community, and a common point of convergence among different works is that a smart security system must

be able to provide a reliable sense of insulation from would-be intruders. Table 1 shows some recent works in this regard.

**Table 1: Related works in awareness and acceptance of smart security systems for buildings**

S/N	Author(s)	Title of Work	Year	Key findings
1	(Froufe et al., 2020)	Smart Buildings: Systems and Drivers	2020	Identified and correlated the main drivers and systems of smart buildings. The main drivers include: technology, integration, flexibility, longevity, health, comfort, satisfaction, security, ecology, energy, and efficiency. The systems include: heating-ventilation-air conditioning, light system, energy system, security system, telecomm system, fire prevention system, vertical transport system, and hydraulic system. The authors proposed a framework for smart home services by focusing on the practicability of each variable from the perspective of supporting user experience.
2	(Kim et al., 2020)	Developing Design Solutions for Smart Homes Through User-Centered Scenarios	2020	Based on developed scenarios, the authors were able to identify residents' behaviors and intentions regarding smart home and its use.
3	(Cannizzaro et al., 2020)	Trust in the smart home: Findings from a nationally representative survey in the UK	2020	The authors discovered that the meaning and value proposition of smart home and smart security have not achieved closure for consumer. Anxiety about the likelihood of a security incident emerges as a prominent factor impacting the adoption of smart home technology.
4	(Oyewole et al., 2019)	Residents' Awareness and Aspiration for Smart Building Features: The Case of Okota, Lagos, Nigeria	2019	Internet facility received the highest ranking as the medium of awareness for residents who were aware of smart building features. Security and safety were the highest aspired feature for a smart building as indicated by the respondents.

One major point that can be inferred from Table 1 is that there is a heightened level of awareness on the application of smart security systems in public buildings, and the general expectation is that buildings which adopt this technology are expected to be better managed and more environment-friendly.

## METHODOLOGY

### Study area

According to the 1991 population census, the population of the FCT was 378,671, Year 2000 projections were put at well over half a million as noted by (Momoh & Benachir, 2018). The 2006 population and Housing census puts the population of Abuja at 1,406,239 with a growth rate of 9.3 per year, 2014 population is projected to be 3,028,80, and phase II of Abuja's development is yet to be completed (Gumel et al., 2020). Figure 1 shows that the federal capital city is within the Abuja municipal area council, and the development of the city is in phases I-IV with each phase further subdivided into districts, as seen in Figure 2.

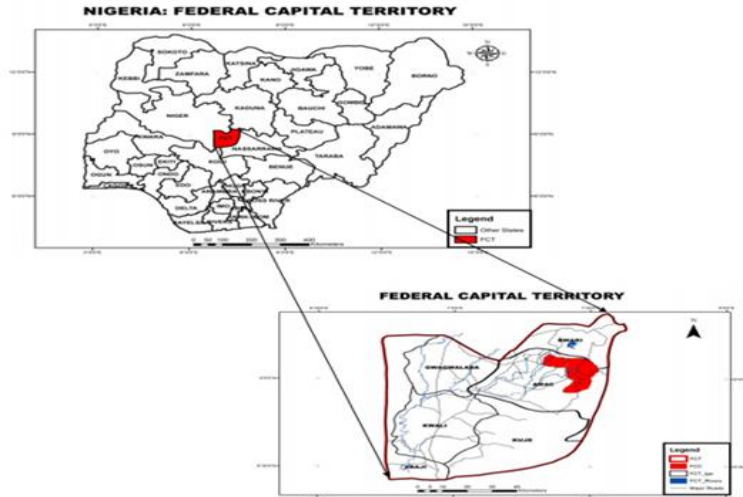

Figure 1: Map of Nigeria showing location of FCT-Abuja (FCDA, 2013)

The Federal Capital Territory as it is popularly known is in the heart of Nigeria. Being equidistant from all parts of the country, it can be accessed quite easily

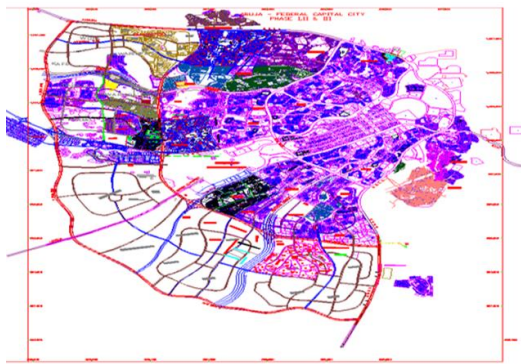

Figure 2: FCT-Abuja Map showing district lay out in phases I- III (FCDA, 2013)

The central area as shown in figure 3, is the hub of the city as well as that of the Nation. This is true not only in the symbolic sense but in the physical sense as well. It covers an area of 1,635.3 hectares (Abuja Master Plan). The design objective of the central area is to create a functioning and organically whole central area early in the life of the capital city by concentrating facilities along the axis to convey a sense of completeness and urbanity (Gumel et al., 2020).



Figure 3: Satellite Image showing Central Business District (CBD) highlighting the Central Business District (Commercial Core) of FCT-Abuja, Nigeria. (FCDA 2013)

The central area is where the important public buildings are sited, in the Abuja master plan, it was proposed to house the National Assembly, legislative and executive offices, official residences, national conference centre, central hospital, embassies, main shopping streets, national square, transit ways, presidential residence, Central Business District (CBD) and national museum. The CBD as one of the districts in the phase 1 of the federal capital city has seven identifiable precincts.

This study adopted a cross-sectional survey research design with a quantitative approach to data collection. The justification for the use of cross-sectional survey include- it is cheap and consumes less time, it makes it possible to collect data from a large pool of subject areas and make necessary comparisons, it captures a specific moment in time, and it provides a snapshot of the frequency of the phenomenon under observation.

For this study, the relationship used in determining the sample size is (Yamane, 1964):

$$n = \frac{N}{1 + N(e)^2}$$

(1)

where n is the sample size, N is the population size, e is the level of precision. With a population  $N = 253$  and  $e = 0.05$

, the sample size n is worked out as follows:

$$n = \frac{253}{1 + 253(0.05)^2} = 154.9770 \approx 155$$

(2)

From the study's population is 253 occupants of selected public buildings within the CBD; 155 occupants were randomly selected based on the value determined in (2). The validated Smart Security System Questionnaire (SSSQ) was used as a data collection instrument. Out of 155 copies of validated SSSQ randomly distributed, the response rate to the study's instrument is 132. Data+ collected, sorted and normally tested were described and reported using frequency, percentage, mean, standard deviation in tabulation format. These statistics were scientifically computed using Statistical Packages for Social Sciences (SPSS). It should be noted that 0.05 was used as a level of significance (p-value) throughout the statistical computations therein.

## RESULTS AND DISCUSSIONS

This section provides results, interpretation, and discussions of data collected for the purpose of achieving research objectives as well as testing the study's null hypotheses. Figure 4 shows that 72 (54.5%) respondents are male while the

remaining 60 (45.5%) are their female counterparts. Similarly, most of these occupants 67 (50.8%), has been working with their respective organizations for at least 6 to 10 years.

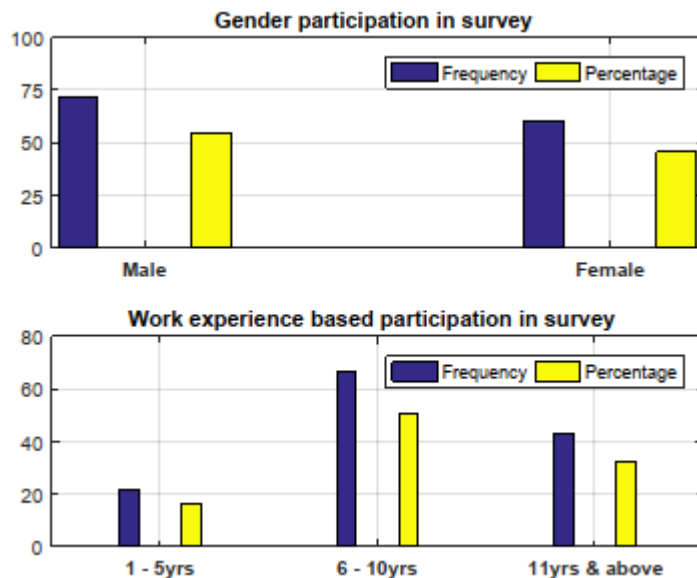

Figure 1: Information of respondents in survey (Source: Field survey, 2019)

It can be seen from figure 1 that there are more male than female occupants in public buildings within CBD -Abuja and these occupants has been working in their environment for at least 6 to 10 years. Hence it can be inferred that the participants adequate knowledge and experience to understand the nature of the security system maintained in the buildings. The buildings in question here are offices, most of which are government offices.

Table 2 shows the level of awareness among respondents on smart security as it applies to public buildings. The data were collected by a cross-sectional survey research design with a quantitative approach to data collection using the study's population of 253 occupants of selected public buildings within the CBD. It can be observed that 79 occupants of public buildings representing 59.8% are moderate aware i.e. they showed an appreciable knowledge about smart security system as building security system; and 36 (27.3%) are highly aware of it. This shows that occupants of selected public buildings in the Central Business District (CBD) FCT-Abuja, Nigeria are significantly aware of the Smart Security System as a security mechanism for public buildings. This finding contradicts that of Chitnis, Deshpande, and Shaligram (2016), who found that out of total 78 only 2.56% are aware of advanced security mechanism.

**Table 2: Level of awareness about Smart Security System among occupants of selected public buildings in CBD Abuja, Nigeria**

Awareness level	Frequency	Percentage
Highly Aware	36	27.3
Moderately Aware	79	59.8
Fairly Aware	8	6.1
Not Aware	9	6.8
Total	132	100.0

Source: Field Survey, 2019

Table 3 shows the level of readiness among the respondents, where it can be seen that more than two-third number of occupants of selected public buildings in Central Business District (CBD) FCT-Abuja agreed with 7 out of 8 items listed in the table. This agreement, indicate that it is likely a good time within the Nigerian community and occupants of public buildings to participate in designing and installing a smart security system in their buildings for safety, confront and privacy.

**Table 3: Readiness level towards the use of Smart Security System among occupants of selected public buildings in Central Business District (CBD) FCT-Abuja, Nigeria**

S/N	Readiness Assessment Checklist (RAC)	Yes		No		Mean	SD	Remark
		N	%	N	%			
1	Have you clearly defined the need that is driving your organization to consider implementing Smart Security System?	91	68.9	41	31.1	1.69	0.465	Yes
2	Is designing a strong evidence-based smart security system an appropriate strategy to address your organization's security challenges?	114	86.4	18	13.6	1.86	0.344	Yes
3	The smart security system is a distraction rather than a solution to security challenges in our building	40	30.3	92	69.7	1.30	0.461	No
4	It is essential that leaders within your organization actively support and champion Smart security system transitions and deliverables.	113	85.6	19	14.4	1.86	0.352	Yes
5	Will your organization provide sufficient staff with the necessary time and resources to support full implementation of smart security system?	90	68.2	42	31.8	1.68	0.468	Yes
6	Will your organization allow time to prepare and continue work on system deliverables?	97	73.5	35	26.5	1.73	0.443	Yes
7	Will your organization be willing to measure and assess progress and continuously improve processes?	107	81.1	25	18.9	1.81	0.393	Yes
8	Will your organization be able to reinforce and reward positive teamwork behaviors and improvements in security processes?	107	81.1	25	18.9	1.81	0.393	Yes

Source: Field Survey, 2019

According to results presented in Table 4, it can be observed that significant number of selected public building occupants that responded to the study agreed that using the system would enable them to accomplish security tasks more quickly; using the system in their job would increase their level of productivity; using the system would make it easier to do their job while in the building; they find the system very useful in their job; using the system would improve their job



performance of security system; and using the system would enhance their effectiveness on the job. These results show that occupants of selected public buildings in Central Business District (CBD) FCT-Abuja have positively perceived usefulness on the use of smart security system as a creative and innovative security system in public buildings.

**Table 4: Perceived usefulness of using smart security system by occupants of selected public buildings in Central Business District (CBD) FCT-Abuja, Nigeria**

S/N	Perceived Usefulness of using Smart Security System in Public Buildings	SA (%)	A (%)	NS (%)	D (%)	SD (%)
1	Using the system would enable me to accomplish security tasks more quickly	56.1	26.5	11.4	3.0	3.0
2	Using the system would improve my job performance of the security system	41.7	41.7	6.8	6.8	3.0
3	Using the system in my job would increase my level of productivity	46.2	34.1	9.8	6.8	3.0
4	Using the system would enhance my effectiveness on the job	38.6	37.9	15.2	5.3	3.0
5	Using the system would make it easier to do my job while in the building	46.2	38.6	9.1	3.0	3.0
6	I would find the system very useful in my job	43.9	44.7	3.0	2.3	6.1

SA = Strongly Agree, A = Agree, NS = Not Sure, D = Disagree, SD = Strongly Disagree

Source: Field Survey, 2019

The one-way ANOVA analysis is shown in figure 2 and figure 3. With a p-value << 0.05 in figure 2, it confirms that there are statistically significant differences between the group means. This is succinctly reflected in the parameters of the columns in figure 3, where the median values, maximum values, and minimum values for the different columns are shown in Table 5.

**Table 5: One-way ANOVA performance metrics for Table 4**

	SA(%)	A(%)	NS(%)	D(%)	SD(%)
Median	45.05	38.25	9.45	4.15	3.00
Maximum value	56.10	44.70	15.20	6.80	6.10
Minimum value	38.60	26.50	3.00	2.30	3.00

The values in Table 5 were deduced from figure 3 where the SA(%) showed the greatest strength and the SD(%) showed the least strength.

ANOVA Table					
Source	SS	df	MS	F	Prob>F
Columns	9434.78	4	2358.69	119.14	6.76095e-16
Error	494.94	25	19.8		
Total	9929.72	29			

Figure 2: One-way ANOVA computation for the columns of Table 4

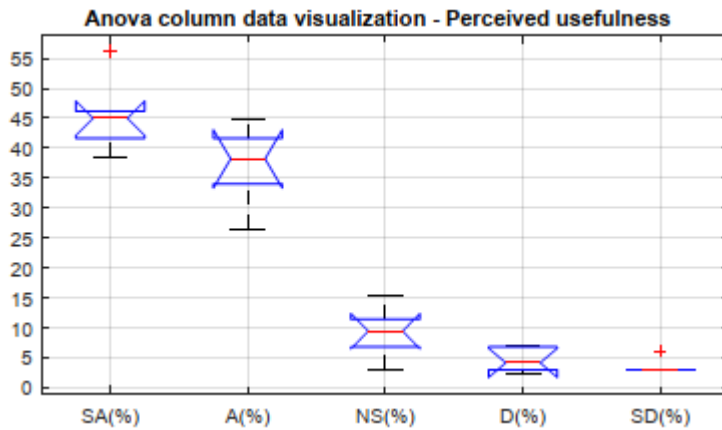

Figure 3: ANOVA visualization of data columns for perceived usefulness

## CONCLUSION

The smart security system should be a top concern for concerned stakeholders who own or occupy public buildings. Moreover, safe and secure building space is the necessity of every member of the organization is working. The smart security system is thus applicable and desirable for occupants safety and convenience. This will be achieved by turning the building into a smart building by intelligent remote monitoring. The smart building comes into picture for controlling and monitoring routine activities of the occupant and external forces. It will give occupants peace of mind, as management can have a close watch and stay connected anytime, anywhere. This study mainly concentrated on the awareness, and acceptance of smart security system among occupants of selected public buildings in the Central Business District (CBD) FCT-Abuja, Nigeria.

The management and occupants of selected public buildings in the Central Business District (CBD) FCT-Abuja are highly aware of the Smart Security System as a security mechanism for public buildings. The management and occupant of the public building in Nigeria shows a high level of readiness, to accept, deploy and implement smart security system in their building Architecture. It was also found that occupants of public buildings in FCT-Abuja have perceived smart security system easy to use as results of the system capable of easily securing their buildings; encouraging skillfulness; flexible to interact with. However, occupants of selected public buildings in Central Business District (CBD) FCT-Abuja, Nigeria perceived smart security system highly useful as it will enable them to accomplish security tasks more quickly; increase their level of productivity; make it easier to do their job, and enhance their effectiveness on the job. Finally, occupants of selected public buildings in FCT-Abuja have a positive attitude towards using smart security system in their building.

Since the level of awareness about smart security system is reasonably high among occupants of public building in Central Business District (CBD) FCT-Abuja. However, awareness is directly related with favorably perceived usefulness of smart security system in Nigeria. These finding brought to our notice that many people are aware of the advanced security system. Thus, it should be appreciated that criminals and intruders always look for easy targets, and by taking appropriate precaution, management and occupants of public buildings can drastically decrease the chances of having their buildings victimized. Also, accurate data awareness in the smart security system can help Architectural service providers to allocate network resources adaptively.

## **RECOMMENDATIONS**

Building security designers and Architectural experts, smart security market promoters, as well as professional bodies, should use of creative and innovative ways of creating and promoting a level of awareness about the privacy, costs and technical implications smart security system design to the public. This bold action will ultimately lead to positive perception and attitude towards the use of a smart security system in the Nigerian environment.

All stakeholders should reach a consensus on minimum security requirements for public building in Nigeria. Industry actors should support security-driven business models, contribute to raising smart security awareness, and develop security assessment methods or frameworks for smart security designers and architectural experts. The management of MDA, NGOs, embassies and, consulates should redesign and re-strategies their building security system to prevent modern security challenges. This can be achieved by contracting recognized professional for training and retraining of their staff about the technical whereabouts of the system.

Finally, Federal Ministry of Finance (FMF), Federal Ministry of Communication Technology (FMOCT), Ministry of Interior, Ministry of Foreign Affairs, Nigerian Communications Commission (NCC), Federal Secretariat and National Information Technology Development Agency (NITDA) should collaborate to provides financial and technical support towards establishing Public Smart Security System (PSSS) for public building; and letter may be commercialized for the benefit of the people of our country.

## **REFERENCES**

- Al-Humairi, S. N. S., & Kamal, A. A. A. (2021). Opportunities and challenges for the building monitoring systems in the age-pandemic of COVID-19: Review and prospects. *Innovative Infrastructure Solutions*, 6(79), 1–10. <https://doi.org/10.1007/s41062-020-00454-0>
- Cannizzaro, S., Procter, R., Ma, S., & Maple, C. (2020). Trust in the smart home: Findings from a nationally representative survey in the UK. *PLoS ONE*, 15(5), 1–30. <https://doi.org/10.1371/journal.pone.0231615>
- Ciholas, P., Lennie, A., Sadigova, P., & Such, J. (2019). The Security of Smart Buildings: a Systematic Literature Review. *ArXiv Preprint*, 1–50.

- Froufe, M. M., Chinelli, C. K., Guedes, A. L. A., Haddad, A. N., Hammad, A. W. A., & Soares, C. A. P. (2020). Smart Buildings: Systems and Drivers. *MDPI - Buildings*, 10(153), 1–20. <https://doi.org/10.3390/buildings10090153>
- Gumel, I. A., Aplin, P., Marston, C. G., & Morley, J. (2020). Time-series satellite imagery demonstrates the progressive failure of a city master plan to control urbanization in Abuja, Nigeria. *Remote Sensing*, 12(7), 1112.
- Hsu, Y. L., Chou, P. H., Chang, C. H., Lin, S. L., Yang, S. C., Su, H. S., ... Kuo, Y. C. (2017). Design and Implementation of a Smart Home System Using Multisensor Data Fusion Technology. *Sensors*, 17, 1631. <https://doi.org/10.3390/s17071631>
- Kim, M. J., Cho, M. E., & Jun, H. J. (2020). Developing Design Solutions for Smart Homes Through User-Centered Scenarios. *Frontiers in Psychology*, 11, 335. <https://doi.org/10.3389/fpsyg.2020.00335>
- Kupchik, A. (2010). *Homeroom security: School discipline in an age of fear*. NYU Press.
- Momoh, J., & Benachir, M. (2018). Urban Development and Housing Demolition in Abuja city: the Benefits of Adopting the Principles of Sustainability. *Journal of Good Governance and Sustainable Development in Africa*, 4(2).
- Olarewaju, I. K., Ayodele, O. E., Michael, F. O., Alaba, E. S., & Abiodun, R. O. (2017). Design and Construction of an Automatic Home Security System Based on GSM Technology and Embedded Microcontroller Unit. *Electrical and Computer Engineering*, 1(1). <https://doi.org/10.11648/j.ece.20170101.14>
- Oyewole, M. O., Araloyin, F. M., & Oyewole, P. T. (2019). Residents 'Awareness and Aspiration for Smart Building Features: The Case of Okota, Lagos, Nigeria. *Nigerian Journal of Environmental Sciences and Technology*, 3(1), 30–40.
- SARHAN, Q. I. (2020). Systematic Survey on Smart Home Safety and Security Systems Using the Arduino Platform. *IEEE Access*, 8, 128362–128384. <https://doi.org/10.1109/ACCESS.2020.3008610>
- To, W., Lee, P. K. C., & Lam, K. (2018). Building professionals 'intention to use smart and sustainable building technologies – An empirical study. *PLoS ONE*, 13(8), 1–17. <https://doi.org/10.1371/journal.pone.0201625>
- Wilson, C., Hargreaves, T., & Hauxwell-Baldwin, R. (2017). Benefits and risks of smart home technologies. *Energy Policy*, 103, 72–83.
- Yamane, T. (1964). *Statistics: An Introductory Analysis*. <https://doi.org/10.2307/139661>



# AWARENESS AND PERCEPTIONS OF CONSTRUCTION PROFESSIONALS ON ENVIRONMENTAL RISKS IN CONSTRUCTION PROJECT DELIVERY IN LAGOS AND ONDO STATES, NIGERIA

Deborah Abosede Ogungbemi<sup>1</sup> and Ayokunle Olubunmi Olanipekun<sup>2</sup>

<sup>1</sup>*Department of Quantity Surveying, Federal University of Technology, Akure, Nigeria*

<sup>2</sup>*School of Built Environment, Massey University, Auckland, New Zealand*

Conventional construction project delivery is very destructive and leads to high environmental risks. Meanwhile, a risk management approach can be employed to manage the environmental risks and prevent destructive project delivery. However, this requires proper identification and evaluation of the environmental risks, but it is yet to be investigated in the research. Therefore, this study assessed the awareness and perceptions of construction professionals on environmental risks in construction project delivery in Lagos and Ondo States, Nigeria. More also, evaluation of the likelihood of occurrence and severity from the perspectives of 100 construction professionals working in environmentally vulnerable areas in Lagos and Ondo States, Nigeria. The survey was presented online using Google forms for the administration of questionnaires to the sampled construction professionals. It comprises two sections. The first section comprises a qualification question about respondents' involvement in a construction project delivery in environmentally vulnerable areas such as the Lagos Island in Lagos State or the Ondo State South Senatorial District in Ondo State. A 'YES' response will enable them to complete the survey, whereas a 'NO' response will automatically terminate their participation in the survey. The second section comprises questions that cast as multiple-choice variables and rated by respondents on a five-point Likert scale about environmental risks and their likelihood of occurrence and severity. Data obtained from the questionnaire survey was analyzed using percentage frequency distribution and mean score. Of the five common environmental risks identified in the literature, the findings reveal that the risk of air pollution is the commonest, most likely to occur and when it does occur it is the most severe. The other environmental risks such as the risks of land degradation and noise and vibration, have high scores which suggest that they are more common, more likely to occur and more severe when they occur. Furthermore, the risk to flora and fauna has the least score in terms of commonness, likelihood to occur and severity. This study concludes that identifying and evaluating environmental risks in terms of commonness, likelihood to occur and severity can be employed for environmental risk management in construction project delivery. The risk of air pollution and the risk to flora and fauna should be accord the highest and least priorities in environmentally vulnerable areas in Lagos and Ondo States in Nigeria. This suggestion is applicable to other environmentally vulnerable areas in Nigeria and other countries where construction professionals have strong environmental vulnerability perceptions.

Keywords: construction project delivery, environmental risks

<sup>1</sup> Deborahabosede001da@gmail.com

<sup>2</sup> A.Olanipekun@massey.ac.nz

## INTRODUCTION

Construction activities lead to high environmental impacts in the construction industry. According to Anigbogu and Keftin (2007), construction project delivery negatively impacts vegetation, produces energy and material wastes, and noise pollution in the environment. The construction process is considered one of the primary sources of environmental pollution (Rasika and Vikram, 2017). Additionally, Ijigah, et al, (2013) stated that, the environmental impact of construction projects includes the menace of environmental pollution, resource depletion, and habitat destruction. Consequently, this destroys the ecosystem, increases desertification and soil erosion. In project parlance, the environmentally destructive nature of construction project delivery poses serious environmental risks.

Risk management is a generic but structured process that involves many sub-processes that can be applied to ensure effective risk management. According to Skorupka (2003), the risk management of projects uses a set of methods and actions to lessen the disturbances that may occur during the lifecycle of a project and hinder the achievements of the project objectives. According to Shankar Neeraj, Balasubramanian (2015), risk management basics are identifying the relevant and potential risks associated with the construction project. It is of considerable importance since the process of risk analysis and management may only be performed on identified potential risks. Rigorous risk management comprises identification, assessment, action and monitoring (Cooper, 2005). The objective of rigorous risk management is to derive a structured framework for managing various risks effectively and efficiently in project delivery phases (Shankar et al, 2015). In practice, the risk management of projects encompasses identifying the influencing factors that could negatively impact project time, cost schedule or quality baselines, and quantifying their associated impact of the identified risk and implementing mitigating measures (Jayasudha and Vidivelli, 2016).

From the understanding of risk management (above), it could be seen that a structured risk management process framework can assist contractors in risk impacts in construction project delivery (Dione and Ruwanpura, 2005). However, concerning environmental risks in construction project delivery, the specific ones are yet to be scientifically identified, and their impacts yet to be quantified. Therefore, contractors cannot effectively manage environmental risks in construction project delivery. To address the problem and contribute to risk management body of knowledge in construction, this study empirically assessed the various environmental risks in construction project delivery. These objectives were investigated in the empirical assessment. The first objective was to assess the environmental risks associated with construction project delivery. The second objective was to evaluate the likelihood of occurrence of the environmental risks in construction project delivery. The third objective was to evaluate the severity of the environmental risks in construction project delivery. It is expected that the empirical assessment will provide an understanding to contractors to manage environmental risks in construction project delivery effectively.

## RISK MANAGEMENT

According to Rehacek (2017), risk management in the construction industry is highly importance because construction projects are not risk-free. Jibrán, et al, (2019) considered risk management a critical management process to realize the project objectives in terms of time, cost, safety, quality, and sustainable environment. Nthatsi Khatleli (2019) described risk management as the deliberate processes of identifying, categorizing, prioritizing and planning risk occurrences before they disrupt project delivery. The authors concluded that risk management is essential to construction activities in minimizing losses and enhancing profitability. Gulam Mohi (2018) admitted that risk management remains a challenging task for construction professionals as its absence makes projects vulnerable to various risks such as technical, sociopolitical and business risks. Pawel Szymanski (2017) mentioned that thoughtful and strategic risk management primarily maximizes positive events and minimizes the negative effects, thus increasing project success.

### ENVIRONMENTAL RISKS IN CONSTRUCTION PROJECT DELIVERY

#### Concept

Environmental risks are defined as risks or potential risks to the environment and its inhabitants. (Nik, Rahman and Esa, 2014) Construction processes are a major contributor to environmental disruption and pollution. Therefore, environmental risks in construction project delivery impact the environment (Ankit, 2013). Environmental risks are those risks that are associated directly (e.g. water discharges) and indirectly (e.g. loss of vegetation) with the construction activities (Pöder, 2006). Environmental risks could also be described as the factors that negatively impact on the time, cost, quality and overall objectives of a project (Aibinu and Jagboro, 2002).

#### Types

Nik, et al, (2014) explored environmental risks associated with construction project delivery, and they are identified and described as follows;

#### *Risk of Land Degradation*

The risk of land degradation is an extensive land disturbance that involves removing vegetation and reshaping topography. Such activities make the soil vulnerable to erosion, which may become airborne and create dust problem or be carried by water into natural water ways, thereby polluting them. Also, soil erosion of the exposed and loose earth lead to a deterioration of water quality in the surrounding water bodies due to siltation. This can result in mud floods and flash floods in immediate or downstream areas during heavy downpours. Furthermore, landslides and slope failure can occur on unstable slopes or when the soil is saturated with water during heavy rainfalls.

#### *Risk to Flora and Fauna*

The risk to flora and fauna is the loss of the biological environment (which is various species of animal and plant life and their habitats) to physical development.

### ***Risk of Water Pollution***

The risk of water pollution is the changes to water quality, and by extension, the reduction in the aesthetic value of water that prevents water usage. During construction, there is a high potential for soil erosion to occur. Risk to water quality is greatest when removing vegetation for initial clearing and grading activities exposes the soil and make it susceptible to erosion. The impacts and risks are greatest during the rainy season, where unavoidable extensive land clearing can increase sediment load into the rivers from erosion of the exposed soil.

### ***Risk of Air Pollution***

The risk of air pollution is the reduction in air quality due to construction activities such as the burning of waste, the emission of fumes and smoke, and the release of chemical impurities such as heavy metals, acid and other toxic bases into the atmosphere. Also, the reduction in air quality due to increased dust particulates in the atmosphere are caused by grading, filling, removals, and demolition activities. Furthermore, air quality may be impacted by emissions from construction equipment and vehicles.

### ***Risk of Noise and Vibration***

The risk of noise and vibration refers to an advanced level of noise to hear, leading to topographical and structural vibration resulting from construction equipment. However, noise and vibration levels due to construction activities in the project area vary depending on the types of equipment used, the location of the equipment, and the operating mode. In practice, adverse impacts resulting from construction noise and vibration are generally limited to areas adjacent to the project site and are temporary in nature.

### **Management of environmental risks in construction projects**

The construction industry must minimize and manage the generation of risks that may affect elements of the environment. To ensure that all reasonable and practicable measures have been taken, attention must be given to the nature of the risks or potential risks that may occur during construction as well as the sensitivity of the receiving environment. The complexity and extent of control measures required will depend largely on the magnitude and duration of the construction activity (Olander and Landin, 2005). Moreover there is a high level of awareness and commitment with regards to protecting the environment among contractors and others involved in the construction industry. Some have already taken measures to comply with all regulations regarding water pollution, noise pollution, dust emission, waste generations etc. In some cases, additional initiatives have also been put in place such as energy conservations, and recycling of materials (Rodriguez et al, 2007).

## **METHODOLOGY**

This study used a quantitative research methodology. This type of methodology was used to enable identified factors to be surveyed and rated on a numeric basis to know the highest occurring factors. The study population was all construction professionals comprising Architects, Engineers, Builders, Quantity Surveyors and Project Managers in Lagos and Ondo States, Nigeria. As shown in Table 1, the total



number of these professionals in both states are 6,543 and 1086 respectively, as obtained from relevant professional organizations in Nigeria.

**Table 1**

S/N	Professionals	Lagos State	Ondo State
1	Quantity surveyor	1297	133
2	Architect	1045	155
3	Builder	765	153
4	Project manager	980	95
5	Engineers, (civil, mechanical or electrical)	2456	550
	Total	6543	1086

Source: NIQS 2019, NIA 2019, NIOB 2019, PMI 2019, NSE 2019

The convenience sampling of construction professionals in the population study was carried out. Convenience sampling can be defined as a nonprobability sampling technique where members of the target population that meet certain practical criteria such as easy accessibility, geographical proximity, willingness to participate are included in the study (Ilker Etikan, et al, 2016). The survey questionnaire was used. Survey research can be defined as collecting information from a sample of individuals through their responses to questions (Check J, Schutt R, 2012). The survey was presented online using Google forms for the administration of questionnaires to the sampled construction professionals. It comprises two sections. The first section comprises a qualification question about respondents 'involvement in a construction project delivery in environmentally vulnerable areas such as the Lagos Island in Lagos State or the Ondo State South Senatorial District in Ondo State. A 'YES 'response will enable them to complete the survey, whereas a 'NO 'response will automatically terminate their participation in the survey. The second section comprises questions that cast as multiple-choice variables and rated by respondents on a five- point Likert scale about environmental risks and their likelihood of occurrence and severity.

The data obtained on objectives one, two and three were analyzed using the mean item score and standard deviation. The mean item score was used for making ranking decision whereby the factor with the highest Mean Item Score (MIS) is ranked as the 1st and the others follow in subsequent descending order, Standard deviation was used in the case where two or more factors have a tie in the mean score. The one with the lesser standard deviation is ranked above the one with a higher standard deviation (Okoko, 2001).

Since a Likert scale of 5 - point was employed for the collection of the data, the formula for Mean Item Score can be written as;

$$MIS = \frac{5f_5+4f_4+3f_3+2f_2+f_1}{f_1+f_2+f_3+f_4+f_5}$$

Where, F is the frequency of each ranking. The basis of ranking the success or the significance of factors using Mean Item Score is based on this premise:

1. Very low "significance" (associated, likelihood of occurrence, severity)
2. Low "significance" (associated, likelihood of occurrence, severity)

3. Moderate "significance (associated, likelihood of occurrence, severity)
4. High "significance" (associated, likelihood of occurrence, severity)
5. Very high "significance" (associated, likelihood of occurrence, severity)

Also the formula for standard deviation is presented below;

$$SD = \sqrt{\frac{\sum(x-\mu)^2}{N}}$$

Where SD = Standard Deviation

$\Sigma$  = Sum of variables

$\mu$  = mean of population

N = number of sample

## RESULTS

### Respondents' background

A total of 100 online survey questionnaires were administered. Results showed that 40% of the respondents were quantity surveyors, 22% of the respondents were architects, 17% were builders, 8% were project managers, and 13% were engineers (civil, mechanical, and electrical). They all belonged to their professional bodies in Nigeria. The results also showed that 55% of the respondents have under-gone environmental training in the past. This shows awareness of the impact of construction activities on the environment.

### *Objective 1: Assessment of environmental risks*

The respondents were asked to respond about their views of the environmental risks associated with construction project delivery. As shown in Table 1, the respondents view air pollution as the most associated environmental risk in construction project delivery with a group mean score of (3.20). The individual mean scores of the sub-risks of air pollution are as follows; Dust from breakages and use of construction materials (3.28), emissions from construction equipment and vehicles (3.26), burning of wastes leading to the emission of fumes and smoke (3.26), and release of chemical impurities such as heavy metals, acid and other toxic bases into the atmosphere (3.02). Therefore, respondents view dust from breakages and construction materials to be the highest sub-risk of air pollution in construction project delivery.

Also, the respondents view the risk of noise and vibration to be the second-most associated environmental risk in construction project delivery, with a group mean score of (3.15). The risk of land degradation follows this as the third most environmental risk associated with construction project delivery with a group mean score of (3.06). Lastly, the respondents view the risk of water pollution, and risk to flora and fauna as the least associated environmental risks in construction project delivery with group mean scores of 2.93 and 2.73, respectively.

**Table 1. Environmental risks in construction project delivery**

Environmental Risk Factors	Mean	Std. Deviation	Group mean	Ranking	Category rank
<b>Risk of air pollution</b>					
Dusts resulting from breakages and use of construction materials	3.28	1.01	3.20	1	1
Emissions from construction equipment and vehicles	3.26	1.13		2	
Burning of wastes leading to the emission of fumes and smoke	3.26	1.21		3	
Increased dust particulates in the atmosphere caused by grading, filling, removals, and other construction activities	3.20	1.09		4	
Release of chemical impurities such as heavy metals, acid and other toxic bases	3.02	1.08		5	
<b>Risk of noise and vibration</b>					
Excessive noise disturbance from the use of construction equipment	3.22	1.04	3.15	1	2
Nuisance claims from neighbors in the areas surrounding the project	3.16	1.03		2	
Earth movement due to excessive vibration during the use of construction equipment	3.08	1.03		3	
<b>Risk of land degradation</b>					
Mud floods and flash floods in immediate or downstream areas during heavy downpours due to eroded topography	3.09	0.93	3.06	1	3
Vulnerability of the soil to erosion due to removal of vegetation and reshaping topography	3.06	0.99		2	
Extensive land disturbance due to the removal of vegetation and reshaping of topography	3.05	0.96		3	
Landslides and slope failure resulting from disturbed topography	3.04	0.95			
<b>Risk of water pollution</b>					
Increased sedimentation load into the rivers due to exposed soil	2.97	1.03	2.93	1	4
Potential for soil erosion due to clearing and grading activities	2.92	1.09		2	
Risk to surrounding water quality due to the removal of vegetation	2.90	1.11		3	
<b>Risk to flora and fauna</b>					
Contamination of plant life and loss of vegetation	2.83	1.02	2.73	1	5
Contamination of natural habitat and disturbance of the ecosystem	2.70	0.95		2	
Contamination of human life and disruption of human activities	2.65	0.99		3	

**Objective 2: Likelihood of occurrence of environmental risks**

The respondents were asked to respond to the likelihood of occurrence of environmental risks in construction project delivery. As shown in Table 2, the respondents view the risk of air pollution to most likely occur in construction project delivery with a group mean score of 3.25. Also, the respondents view the

risk of land degradation and risk of noise and vibration to be second-most likely to occur in construction project delivery, with both having a group mean score of 3.18. This is followed by the risk of water pollution with a group mean score of 3.04. Lastly, the respondents view the risk to flora and fauna as the least likely environmental risk to occur in construction project delivery, with a group mean score of 2.72.

**Table 2. Likelihood of Occurrence of Environmental Risks in Construction Project Delivery**

Likelihood of Occurrence	Mean	Std. Deviation	Group mean	Ranking	Category rank
<b>Risk of air pollution</b>					
Increased dust particulates in the atmosphere caused by grading, filling, removals, and other construction activities	3.35	1.04	3.25	1	1
Dusts resulting from breakages and use of construction materials	3.29	1.00		2	
Emissions from construction equipment and vehicles	3.23	0.95		3	
Burning of wastes leading to the emission of fumes and smoke	3.20	0.93		4	
Release of chemical impurities such as heavy metals, acid and other toxic bases	3.18	0.98		5	
<b>Risk of land degradation</b>					
Extensive land disturbance due to the removal of vegetation and reshaping of topography	3.34	0.84	3.18	1	2
Vulnerability of the soil to erosion due to removal of vegetation and reshaping topography	3.19	0.95		2	
Landslides and slope failure resulting from disturbed topography	3.14	0.84		3	
Mud floods and flash floods in immediate or downstream areas during heavy downpours due to eroded topography	3.06	0.89		4	
<b>Risk from noise and vibration</b>					
Excessive noise disturbance from the use of construction equipment	3.30	0.90	3.18	1	3
Earth movement due to excessive vibration during the use of construction equipment	3.14	0.88		2	
Nuisance claims from neighbors in the areas surrounding the project	3.09	0.89		3	
<b>Risk of water pollution</b>					
Risk to surrounding water quality due to the removal of vegetation	3.07	0.99	3.04	1	4
Increased sedimentation load into the rivers due to exposed soil	3.04	0.91		2	
Potential for soil erosion due to clearing and grading activities	3.00	1.02		3	
<b>Risk to flora and fauna</b>					
Contamination of plant life and loss of vegetation	2.90	0.99	2.72	1	5
Contamination of natural habitat and disturbance of the ecosystem	2.70	1.07		2	
Contamination of human life and disruption of human activities	2.57	1.08		3	

**Objective 3: Severity of environmental risks**

The respondents were asked to respond to the severity of environmental risks in construction project delivery. As shown in Table 3, the respondents view the risk of air pollution as the most severe in construction project delivery with a group mean score of 3.55. The respondents also view the risk of noise and vibration as the second-most severe environmental risks in construction project delivery with a group mean score of 3.09. This is followed by the risk of land degradation and water pollution with group mean scores of 3.06 and 3.01, respectively. Lastly, the respondents view the risk to flora and fauna as the least severe environmental risks in construction project delivery with a group mean score of 2.83.

**Table 3. Severity of Environmental Risks on Construction Project Delivery**

Severity	Mean	Std. Deviation	Group mean	Ranking	Category rank
<b>Risk of air pollution</b>					
Dusts resulting from breakages and use of construction materials	3.24	0.91	3.15	1	1
Emissions from construction equipment and vehicles	3.17	1.07		2	
Increased dust particulates in the atmosphere caused by grading, filling, removals, and other construction activities	3.16	0.97		3	
Burning of wastes leading to the emission of fumes and smoke	3.13	0.84		4	
Release of chemical impurities such as heavy metals, acid and other toxic bases	3.05	0.99		5	
<b>Risk from noise and vibration</b>					
Nuisance claims from neighbors in the areas surrounding the project	3.14	0.89	3.09	1	2
Excessive noise disturbance from the use of construction equipment	3.09	0.95		2	
Earth movement due to excessive vibration during the use of construction equipment	3.05	0.98		3	
<b>Risk of water pollution</b>					
Potential for soil erosion due to clearing and grading activities	3.09	0.95	3.01	1	4
Increased sedimentation load into the rivers due to exposed soil	2.97	0.97		2	
Risk to surrounding water quality due to the removal of vegetation	2.96	0.84		3	
<b>Risk of land degradation</b>					
Mud floods and flash floods in immediate or downstream areas during heavy downpours due to eroded topography	3.09	0.93	3.06	1	3
Extensive land disturbance due to the removal of vegetation and reshaping of topography	3.08	0.94		2	
Landslides and slope failure resulting from disturbed topography	3.04	0.90		3	
Vulnerability of the soil to erosion due to removal of vegetation and reshaping topography	3.04	0.99		4	
<b>Risk to flora and fauna</b>					
Contamination of natural habitat and disturbance of the ecosystem	2.93	1.07	2.83	1	5
Contamination of plant life and loss of vegetation	2.87	0.95		2	
Contamination of human life and disruption of human activities	2.70	1.06		3	

## **DISCUSSION OF FINDINGS**

This research focused on the awareness and perceptions of construction professionals on the various environmental risks associated with construction project delivery in Lagos and Ondo States, Nigeria. It also identified the likelihood of occurrence as well as the severity of environmental risks on construction project delivery. The analyses revealed that the risk of air pollution is the most common environmental risk during project delivery with a group mean score of 3.20. Respondents view the risk of air pollution and all the sub- categories as the most common risk to occur in construction project delivery. Furthermore, the analyses show that the most likely to occur and also most severe when it occurs is the risk of air pollution. The reason why the environmental risk of air pollution is the most associated with construction project delivery is the negative impact it imposes on construction project delivery. The risk of air pollution occurs as a result of dusts from breakages and use of construction materials, emissions from construction equipment and vehicles, burning of wastes leading to the emission of fumes and smoke (Nik et al, 2014). Therefore, environmental risks in construction is any occurrence or action that poses a negative effect on the delivery of project objectives (Ankit, 2013). The result of the analysis of the likelihood of occurrence and severity of environmental risks during construction project delivery show that the most likely risk to occur during construction project delivery is risk of air pollution from increased dust particulates in the atmosphere caused by grading, filling, removals, and other construction activities. More also, the most severe environmental risk is the risk of air pollution from dust resulting from breakages and the use of construction materials.

According to Rasika and Vikram (2017), in their study on environmental risks in construction projects, they identified the risk of land degradation as the most likely and severe risk to occur. Furthermore, the risk of air pollution includes, dust resulting from breakages and the use of construction materials, emissions from construction equipment and vehicles, release of chemical impurities such as heavy metals, acid and other toxic bases (Nik and Esa 2014). Additionally, the risk of noise pollution such as excessive noise disturbance from the use of construction equipment, earth movement due to excessive vibration during the use of construction equipment also poses a great environmental risk on construction project delivery (Mentiki, 2015). Furthermore, the risk of water pollution such as flooding and washing away the top surface of the earth is the most likely risk that affects project delivery (Hall and Meadowcroft, 2002).

## **CONCLUSION**

This research focused on the awareness and perceptions of construction professionals on the environmental risks in construction project delivery in Lagos and Ondo States, Nigeria, and their likelihood of occurrence and severity to provide an empirical understanding of the subject. It is expected that the understanding will help contractors to manage environmental risks in construction project delivery effectively. The conclusion is that the risk of air pollution is the most common environmental risk in construction project delivery. It is also the risk that is most likely to occur and most severe when it occurs in construction project delivery. Also, the risk of noise and vibration and the risk of water pollution are the second-most

common, likely to occur and severe environmental risks in construction project delivery. The risk to flora and fauna is the least most common, likely to occur and severe environmental risk in construction project delivery. Risk avoidance involves a conscious decision on the part of an organisation to avoid a particular risk related to project delivery completely by discontinuing the operation producing the risk. Since air pollution has been identified as the most common, likely to occur and severe risk to project delivery when it occurs, contractors should replace hazardous chemicals with non-harmful ones. The burning of wastes should be done in an enclosed vicinity; these recommendations will help stop the risk potential of air pollution to project delivery.

## LIMITATION OF STUDY

This research focused on the awareness and perceptions of construction professionals on the environmental risks in construction project delivery in Lagos and Ondo States, Nigeria, and their likelihood of occurrence and severity to provide an empirical understanding of the subject. The limitation is that the study obtained responses from construction professionals in an urban setting and the findings may not reflect the opinion of professionals in a rural setting. Further research on this topic can obtain the opinions of professionals in rural settings and compare the results with this study's.

## REFERENCES

- Ahmed, O. J., & Almishari, S. (2003) risk assessment in construction J. Constr. Eng. Manage., Vol129, Issue No.5.
- Anigbogu, A., & Keftin, N. A. (2007). Environmental Impact of Construction Projects in Nigeria an Assessment of the order of Significance. *Journal of Environmental Sciences*, 11 (1), 78-84.
- Aibinu, A. A., & Odeyinka, H. A. (2006). Construction delays and their causative factors in Nigeria. *Journal of Construction Engineering and Management ASCE/ July*.
- Ameyaw, E., & Chan, A. (2015). Evaluation and ranking of risk factors in Public-Private Partnership Water Supply Projects in Developing Countries using Fuzzy Synthetic Evaluation Approach. *Expert Systems with Applications*.
- Aibinu, A. A., & Jagboro, G. O. (2002). The Effects of Construction delays on project delivery in Nigeria Construction Industry. *International journal of project management* 20(8), 593-599.
- Alfrdel Cano, & M. Pilar de la Cruz, (2002) Integrated Methodology for Project Risk Management, *Journal of Construction Engineering and Management, ASCE*.
- Adnan E., & Jaser A. M. (2008). Risk Management in Building Projects: Owners Perspective. *The Islamic University Journal*. ISSN1726-6807.
- Chan, A. P. C., & Tam, C. M. (2000) Factors affecting the quality of building projects in Hong Kong. *International Journal of Quality & Reliability Management*, Vol. 17.
- Cheng S. G., & Hamzah A. R. (2013). The Identification and Management of Major Risks in the Malaysian Construction Industry. *Journal of Construction in Developing Countries*.
- Check J., Schutt R. K. Survey research. Editors. *Research methods in education*. Thousand Oaks, CA: Sage Publications; (2012). Pp. 159- 185.

- Dimabo O. O., & Oduoza C. F. (2013). Risk Assessment Framework for Building Construction Projects 'in Developing Countries. *International Journal of Construction Engineering and Management*. P-ISSN: 2326-1080 ISSN: 2326-1102.
- Edoka A. Ijigah, Richard A. Jimoh, Bamidele O., & A. Ade. (2013). An Assessment of Environmental Impacts of Building Construction Projects.
- Ilker Etikan, Sulaiman Abubakar, & Rukayya Sunusi, (2016). Comparison of convenience sampling and purposive sampling. *American journal of theoretical*
- Jibran, K., Rehman, A., Muhammad, A., & Qazi, S. (2019). Risk Management in Construction Projects: Perspective of Contractors and Owners
- Jim Hall, I. C & Meadowcroft. (2002). Towards risk- based flood hazard management in the UK DOI: 10.1680/cien.150.5.36.38631
- Pawel Szymanski (2017), Risk Management in Construction Projects. DOI: 10.1016/j.proeng.2017.11.036.
- Patel Ankit Mahendra, Jayeshkumar R Pitroda, & J. J. Bhavsar. (2013). A study of risk management techniques for construction projects in developing countries. *International journal of innovative technology and Exploring Engineering* 3 (5), 139-142.
- Rasika S. Patil, & Vikram K.Vichare. (2017). Environmental Risk Assessment for Construction Project through CEMP. *IRE Journals* |Volume 1 Issue 3| ISSN 2456-8880.
- Shankar Neeraj Balasubramanian. (2015). Assessment of Risk in Construction Industry. *International Research journal of Engineering and Technology (IRJET)*.





# AWARENESS OF GREEN INFRASTRUCTURE AND ITS SOCIO-DEMOGRAPHIC PREDICTORS AMONG RESIDENTS OF LAGOS METROPOLIS, NIGERIA

Adedotun Ayodele Dipeolu<sup>1</sup>, Eziyi Offia Ibem<sup>2</sup>, Joseph Akinlabi Fadamiro<sup>3</sup>, Gabriel Fadairo<sup>4</sup>, Joseph Adeniran Adedeji<sup>5</sup> and Akintunde Olaniyi Onamade<sup>6</sup>

<sup>1</sup>*Department of Architecture, College of Engineering and Environmental Studies, Olabisi Onabanjo University, Ogun State, Nigeria*

<sup>2</sup>*Department of Architecture, Faculty of Environmental Studies, University of Nigeria, Enugu Campus, Enugu State, Nigeria*

<sup>3,4,5</sup>*Department of Architecture, School of Environmental Technology, Federal University of Technology Akure Ondo State, Nigeria*

<sup>6</sup>*Department of Architecture, Caleb University, Imota-Lagos State, Nigeria*

Green Infrastructure (GI) is being promoted as a strategy to mitigate the adverse effects of environmental sustainability challenges. However, the extent to which residents are aware of the different types of GI in order to show stewardship and also enjoy the benefits provided by these facilities remains unclear, especially in the global South. This study examined residents' level of awareness of GI and its socio-demographic predictors in selected neighbourhoods in Lagos Metropolis, Nigeria. Totally, 1560 residents completed a semi-structured questionnaire using multi-stage sampling technique. Descriptive and multiple regression analysis were performed. Results show that 22 types of GI existed in the study area but a high proportion of the respondents were only aware of green gardens, parks, grasses, street trees, and sport fields. Marital status, education, income among others, emerged as significant predictors of GI awareness among respondents. City managers and policy makers should focus more on these identified factors in their attempts to improve the quantity and quality of GI and in creating more awareness among residents in Lagos Metropolis and other cities in sub-Saharan Africa.

Keywords: awareness, conservation, environmental sustainability, green infrastructure (GI), urban centre

## INTRODUCTION

Contemporary cities and their residents are contending with a myriad of sustainability challenges such as continuous green spaces depletion, climate

<sup>1</sup> dipeolu.adedotun@oouagoiwoye.edu.ng

<sup>2</sup> eziyi.ibem@unn.edu.ng

<sup>3</sup> joechrisdamiro@yahoo.com

<sup>4</sup> gabblegroup2000@yahoo.com

<sup>5</sup> niranadedeji@yahoo.com

<sup>6</sup> onamadeasso@yahoo.com

change, uncontrolled population increase, pandemics and several others that seek to undermine their growth, development, and well-being. One aspect of sustainability that has continued to call for research attention is environmental sustainability (Lafortezza, Davies, Sanesi & Konijnendijk, 2013; Wolch, Byrne & Newell, 2014; Dipeolu & Ibem, 2020). Current realities indicate that among other things, human population explosion and high rate of urbanization have led to loss of contact with nature in most urban communities around the world (UN-Habitat, 2014; WHO, 2016). Moreover, human activities which have come with challenges of massive loss of biodiversity and natural habitat fragmentation, air pollution and urban flooding (Wolch et al. 2014; Moskel & Allred, 2013) demand strategic actions that would help restore quality of the rapidly degraded physical environment.

One of the strategies considered as having potential benefit of mitigating some of the key environmental sustainability challenges is the integration of urban Green Infrastructure (GI) in residential neighbourhoods. Generally, GI has been defined as a collection of green spaces and natural ecosystem that serves multiple functions to human beings (Benedict & McMahon, 2002). They include but not limited to parks and gardens, sport fields, stream, rivers, community gardens and forests, street trees, and nature conservation areas, green walls and school yards (Roy, Byrne & Pickering, 2012; Wolch et al, 2014).

Urban GI play significant roles in mitigating environmental sustainability challenges. It helps to reduce rapid increase in urban temperature and controls fragmentation of natural environment (Gómez-Muñoz, Porta-Gándarab & Fernándezc, 2010) among several other benefits. Furthermore, empirical studies have shown that having contact and viewing natural settings can contribute to reducing emotional stress and mental fatigue (Kaplan & Kaplan, 1989; Hartig et al, 2003), and that the presence of GI in urban residential areas can prevent or reduce the incidences of psychological distress and aggression among residents (Kuo, 2001), and promote social interactions and cohesion among people (Seeland & Nicolè, 2006).

In spite of the various benefits associated with GI, a lack of awareness of GI and willingness to take responsibility for stewardship has been identified as reasons why residents may show wrong attitude to the conservation and maintenance of these facilities (Moskel & Allred, 2013). For example, Zhang, Hussain, Deng, and Letson (2007) reported that in Alabama, the USA, lack of awareness of natural resource management programmes was linked to strong beliefs about government responsibility in urban forest management and residents' unwillingness to take responsibility for stewardship. Previous studies (Benedict & McMahon, 2002; Moskel & Allred, 2013) have also shown that although, urban residents are frequently encouraged to show environmentally-friendly attitudes towards the environment by engaging in environment greening practices, preservation, conservation of the environment and visiting GI sites; lack of awareness of the different types of GI in the neighbourhoods had contributed to most residents' inability to take advantage of the benefits associated with GI.

In recognition of the role of GI in environmental sustainability and the associated health benefits, governments across nations are taking steps to improve the quantity and quality of GI within their cities (Dipeolu, 2017; Adegun, 2018). The

Lagos State Government in southwest Nigeria is not left out in this. The government had in 2011 established the Lagos State Parks and Gardens Agency (LASPARK) to oversee the environmental greening project of Lagos megacity. LASPARK had since then continued to develop and maintain different types of GI in this city. However, up till now there has been very little documented evidence of the different types of GI provided and residents' level of awareness of these in their neighbourhoods. This has contributed to obscuring our understanding of the residents' level of consciousness and sense of value of the GI provided by the LASPARK. It is against this background that this research sought to assess the level of awareness of the different types of GI among residents and socio-demographic variables that influence this in Lagos Metropolis, Nigeria. The specific objectives are to:

- i. identify the different types of green infrastructure available in selected neighbourhoods in Lagos Metropolis, Nigeria
- ii. examine the levels of awareness of the existence of the different types of green infrastructure in the study areas; and
- iii. investigate the socio-demographic factors that mostly influence residents' levels of awareness of green infrastructure in selected residential neighbourhoods in Lagos Metropolis, Nigeria.

This study makes contribution to knowledge by revealing the extent to which residents of Lagos Metropolis are aware of the different types of GI in their neighbourhoods which in turn will determine their readiness for stewardship and the extent to which residents can enjoy the benefits provided by these facilities. It also uncovers the specific socio-demographic factors that determine residents' level of awareness of GI within the urban environment. In view of these, it is expected that findings of this study will inform policies and practice related to GI provision, protection, and maintenance in a rapidly growing megacity like Lagos and other cities in the world that share similar experience with Lagos.

## **CONTEXT OF STUDY**

Located in Southwest Nigeria, Lagos state is one of the 36 states that make of the Federal Republic of Nigeria (see figure 1). It lies approximately between longitude 20 42"E and 30 42"E and latitude 60 22"N and 60 52"N and compared to states in Nigeria, it has the smallest landmass.

Metropolitan Lagos is bounded by Ojo and Ijanikin settlements bordered to the west and east by Lekki and to the northern by Ikorodu and Alagbado in Ifako-Ijaiye and Alimosho Local Government areas that share common boundary with Sango-Ota in Ogun State (Oduwaye, 2009). for administrative convenience, Lagos State is divided into 20 Local Government Areas and 16 of them constitute the Lagos Metropolitan Area (see figure 2) while the remaining four Local Government Areas, namely Ikorodu, Epe, Badagry and Ibeju/Lekki are in the sub-urban areas of Lagos State.

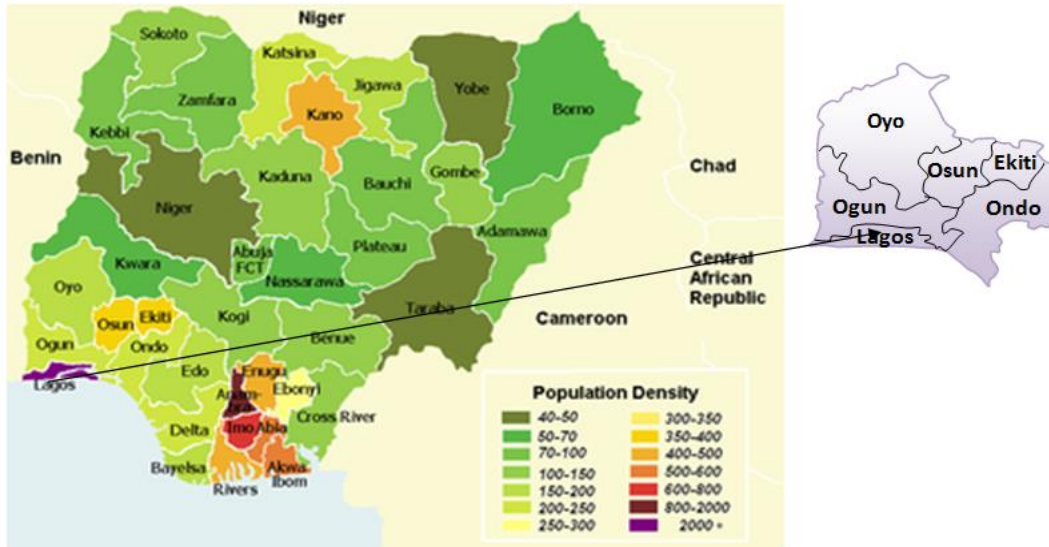

Figure 1: Map of The Federal Republic of Nigeria Showing the Location of Lagos State

Source: Federal Ministry of Environment, Abuja-Nigeria



Figure 2: Map of Lagos Metropolis showing the four randomly sampled LGAs

Source: Lagos State Ministry of Physical Planning

Lagos is an established center for regional, national, and international trade activities and can be accessed through road, rail, water, and air transport facilities (Oduwaye, 2009). Apart from being the hub of business and economic activities in Nigeria, Lagos is located along the coastal region of Africa with massive residential, industrial, and commercial developments that come with significant threat to sustainability of its environment (Adelekan, 2010).

## LITERATURE REVIEW

### Concept of green infrastructure

Historical facts show that the idea of Green Infrastructure (GI) originated in the United States in the mid-1990s in recognition of the significance of the natural environment and its "life support" functions in decisions about land use planning (Sandstrom, 2002). Since then, the literature has been inundated with various definitions and conceptions of GI. For instance, Sandstrom (2002) described GI as consisting of all natural, semi-natural and artificial multifunctional ecological systems within, around, and between urban areas in different spatial scales. Benedict and McMahon (2002) also posited that GI is collection of waterways, wetlands, woodlands, wildlife habitats, and other natural areas such as greenways, parks, and other conservation lands; working farms, ranches and forests and wilderness and other open spaces that support native species, maintain natural ecological processes, sustain air and water resources and contribute to the health and quality of life for people.

From these definitions, it can be inferred that GI include networks natural, semi-natural and artificial elements with green, tree, aquatic features and landscapes that bring nature closer to man, conserve the environment and promote biodiversity. These definitions are very instructive in noting that GI is a vital component of the ecological systems that links the different ecological features with the goal of ensuring ecological balance. In sum, it can be argued that green infrastructure has its origin in two important concepts: linking parks and other green spaces for the benefit of people, and preserving and linking natural areas to benefit biodiversity and counter habitat fragmentation. As explained by Pakzada and Osmonda (2016) these two aspects are vital to the multifunctional attributes of GI.

### Green infrastructure and their importance in environmental sustainability

From the review of literature, it was found that green infrastructure (GI) is of different types and occurs in different spatial scales. They can be categorized into four different groups; namely a green feature GI, tree feature GI, water feature GI and other spaces GI (Wolch et al., 2014; Mullaney, Lucke & Trueman, 2015; Dipeolu, 2017; Adegun, 2018). The components of each of these groups are indicated in Table 1.

**Table 1: Categories of green infrastructure**

Group 1	Group 2	Group 3	Group 4
Green Spaces	Tree features	Water features	Others
Green roofs City farms (urban agriculture) Grasses Sport fields Green parks Green garden Green walls	Forests Street trees Horticulture Woodlands Urban/Community forest	Floodplains Streams Rivers Lakes Ponds Fountains	Other open spaces Non green Parks Permeable pavement School yards Wild life habitat Cemetery

Green Spaces: are GI that are basically of green features and mostly of plant materials

Tree Features: are GI that are mostly of trees features and their assemblage

Water Features: are GI of water/aquatic ecosystems

Other Features: are of GI facilities that cannot be categorised into any of the first three groups

Source: Authors compilation (2020)

The quest for development and modernisation has brought with it the loss of natural landscape and biodiversity and massive environmental degradation, and fragmentation with their attendant consequences on man and the ecological environment (Naumann et al, 2011). Added to these is the replacement of the hitherto traditional land-use practices by more intensive, mechanised, and industrial-scale production activities, especially in the agricultural sector, which among other things have depleted the natural resource base and weakened the ecological systems, their functions, and threatened the survival of the biodiversity they support (Naumann et al., 2011; Dipeolu & Ibem, 2020; Dipeolu, Ibem & Fadamiro, 2021). Consequent upon these, the natural environment has gradually lost its capacity to provide some basic services and amenities needed for sustainable growth and development; and thus, the earth is under serious threat of environmental degradation, diseases and climate change.

In the midst of these challenges, GI has been reported as having the capacity to slow down the rate of environmental degradation and help the environment regain its capacity to support biodiversity by providing various environment-related benefits such as carbon sequestration, improved air and water quality, control of air pollution and urban heat island effect (Gómez-Munoz et al, 2010; Pakzada & Osmonda, 2016). It is also known that the provision of GI contributes to energy conservation initiatives by insulating buildings, shading building envelopes, and ameliorating the urban heat island effect (Adegun, 2018). Further, the integration of GI into the planning and design phase of physical development projects can result to cost effective and climate change resilience-built environment (Zuniga-Teran et al, 2020). It is for these benefits that Adegun (2018) noted that GI has come to be recognised as an indispensable aspect of urban environmental sustainability initiative in contemporary times.

### **Environmental awareness and its socio-demographic predictors**

The concept of awareness has been studied in the different academic and professional disciplines, especially in education and environmental psychology (Darling-Hammonda et al, 2020; Roeser & Peck, 2009; Steg & Vlek, 2009). In its simplest form, awareness has been defined as the ability of someone to notice things, that is a state of being conscious of the existence of anything, place, idea, skill or knowledge (Biesta & Osberg, 2007). In the context of education, awareness is all about being fully conscious of what is being taught (Schank, 2004), and thus Hadzigeorgiou (2012) insist that awareness is a prerequisite for significant learning and it offers to learners the opportunity of developing a better understanding of the world around them (Jardine, Clifford & Friesen, 2003; Schank, 2004).

In the built environment, awareness or consciousness deals with the process of equipping people with knowledge and skills that can help them develop the right attitudes towards their surrounding environment (Üstün & Celep, 2007). It also

involves developing a better understanding of how man interacts with the environment and how his activities affect it (Steg & Vlek, 2009). Environmental awareness can be viewed from two perspectives: perception and behavioural. Whereas the former deals with people's objective knowledge of environmental issues and realities, the later concerns their attitudes towards the environment either to protect or abuse it (Hadzigeorgiou, 2012). Wals (2011) has associated environmental awareness with critical thinking, which has direct linked with environmental knowledge, attitudes, and actions (Dimopoulos, Paraskevopoulos & Pantis, 2009; Hadzigeorgiou, 2012) leading to a change in attitude, which in turn, is a prerequisite for a change in behaviour and actions. Therefore, the Swedish International Development Cooperation Agency (1999: 32) explained that "environmental awareness can lead to having in a community of people who are well-informed and have adequate knowledge and interest of what is happening to their environment and are willing to take necessary steps in solving environmental problems". This implies that a high level of environmental awareness in a community entails having a critical mass of people who are deeply interested in the environmental matters and have a positive attitude toward addressing them. Hence, environmental awareness is a key to addressing environmental sustainability challenges.

Regarding the predictors of environmental awareness, the study by Üstün and Celep (2007) reveals that several studies have shown that the level of environmental consciousness is determined by several personal factors. Top among the personal factors often linked to environmental awareness are age, gender, education and income (Ma & Bateson, 1999; Silvennoinen et al, 2002; Üstün & Celep, 2007). Specifically, previous studies (Wall, 1995; Dietz, Stern & Guagnano, 1998; Ewert & Baker, 2001) have shown that environmental consciousness is positively associated with the level of one's education and that higher educational attainment enhances one's ability to understand his/her environment better resulting in a higher level of awareness of environmental issues. Similarly, environmental awareness has also been positively linked with one's income. In fact, the study by Üstün and Celep (2007) reveals that compared to low-income people, high income earners are likely to show more interest in environmental issues because the former are more likely to be concerned with issues of how to meet the basic needs of life than understanding the components of their physical environment.

Age is also one of those socio-demographic factors with strong negative influence on environmental awareness. Several authors (Gökşen, Adaman & Zenginobuz, 2002; Üstün & Celep, 2007) have reported that whereas older people are not usually open to learning new things and ideas, the young people are ready to and very enthusiastic to explore their environment and identify new developments about it. Therefore, environmental awareness seems to decline with age. There is also the gender factor, which according to Gökşen et al. (2002), studies are not certain about who between the male and female folks has stronger environmental consciousness. However, Dietz, Stern and Guagnano (1998) were of the view that on the one hand since men have been more active in education and social life over the years than women, it expected that men are more aware of the environmental issues than the women. On the other hand, since women have more social responsibilities than their male counterparts, they are believed to show more

concerned with the environmental issues, and thus seem to develop a better consciousness of their environment. In addition to the aforementioned socio-demographic factors, the current study also investigated the association between awareness of GI and marital status, household size, religious affiliation and employment status, which before now have received very little research attention, especially, from the perspective of a developing country.

## RESEARCH METHODS

This paper draws on data generated from a bigger research project that investigated green infrastructure in Lagos State, Nigeria. Totally, 1560 residents participated in this study. The data came from a survey of residents in four (Ikeja, Kosofe, Lagos Island and Surulere) of 16 randomly selected Local Government Areas in Lagos State as shown in Figure 2. The sample frame consisted of the 16 Local Government Areas (LGAs) in Lagos Metropolis, and the selected LGAs were sub-divided into neighbourhoods as defined by Enumeration Areas (EAs). Since not all the residents in the selected neighbourhood were included in the survey, the following formula presented in equation 1 was used to calculate the sample size.

$$n = \frac{(Z_{\alpha})^2 r(1-r)fk}{phe^2} \text{-----equation (1) (Turner 2003)}$$

Where:  $n$  represented the sample size,  $z_{\alpha} = 1.96$  is the critical value of the Normal Distribution obtained from the Table of Standard Normal Distribution at 95% confidence level,  $r = 50\%$  representing estimated proportion of the respondents in the survey  $f = 4$  is the design effect, while  $k = 20\%$  and represents non-response rate,  $p = 0.03 \times 18 = 0.54$  and it is the proportion of the total population of the target population and upon which the parameter,  $r$ , is based,  $h = 6$  is the average number of persons per household, which according to Turner (2003) is often around 6 in most developing countries  $e = 0.05r$  is the margin of error or level of precision set at 5% of  $r$ .

Applying this formula, the same size was calculated thus:

$$n = \frac{(1.96^2 \times 0.5 \times 0.5 \times 4 \times 0.2)}{[0.54 \times 6 \times (0.05 \times 0.5)^2]} = 379.4 \approx 380 \text{-----}$$

equation (2)

The minimum number of participants as calculated was 380 participants per Local Government Area, giving a total of 1,520 participants.

The study used a semi-structured questionnaire to collect data from the participants. The questionnaire was designed by the authors based on findings from the review of relevant literature. It was structured into sections and was used to gather data on the residents' socio-demographic characteristics such as gender, age, family size, marital status, household size, religion, ethnic group, occupation, and rank in occupation/income level. Another section was used to collect data on



the residents' level of awareness of GI within their neighbourhood. In doing this, the different types GI identified from the literature (Roy et al, 2012; Wolch et al, 2014; Mullaney, Lucke & Trueman, 2015) were grouped into four namely: Green spaces GI, Tree features GI, Water features GI and other spaces green infrastructure. Respondents were asked to firstly indicate their awareness using two options: "I am Aware" and "I am Not Aware" and secondly, to identify from the list of GI the ones present in their neighbourhoods. To ensure the validity of findings of this study, the questionnaire instrument used was pre-tested in an unselected Local Government area of Lagos Metropolis and feedback incorporated into the final version of the questionnaire administered to the residents.

The data collection process was preceded with visits by the first author to the National Population Commission (NPC) office in Lagos State to request and obtain the lists and maps of Enumeration Areas (EAs) in Lagos Metropolis. Consequently, the participants were selected from these identified EAs. The survey took place between March and July 2017 in the study area. The number of sampling intervals (k) was determined by dividing the number of houses in an EA by the sample size for each EA. In each EA, households were systematically sampled from the list of numbered houses until the required number allocated to the EAs was achieved. The sampling technique involved selecting the first (1st) house at the nodal point within each EA, while others households were systematically selected based on the predetermined sampling interval (k). A copy of the questionnaire was given by hand to every consenting household head or adult representative found in each house visited. A total of 1600 copies of the questionnaire were administered to the residents by the researchers and trained research assistants. However, 1560 representing around 97.5% of the total number of questionnaires administered were retrieved and found to have been correctly filled by the respondents.

The data were analysed using descriptive and inferential statistics. First, frequency tables and cross tabulations were used to explore the distribution of the data and to enhance data cleaning/editing. The total raw scores were calculated for each group of the GI type as the sum of GI facilities available in the area as indicated by the respondent. Percentage scores were then calculated and compared for each GI type across the four LGAs. The percentage score of respondents' levels of awareness of each GI were then compared across the four Local Governments in the study area. The Categorical Regression Analysis with optimal scaling technique otherwise known as CATREG was used to examine the variance explained by R<sup>2</sup>, identify, and compare the relative contributions of the predictors of awareness of GI types amongst the respondents. The CATREG was used because the data were mixture of nominal and ordinal variables and according to previous authors (Shrestha 2009; Ibem & Aduwo, 2013), CATREG is suited for datasets of this nature.

## **RESULTS**

### **Socio-demographic profile of the participants**

Table 2 shows result of the socio-demographic profiles of participants in the survey. From the result, it is obvious that around 49.3% of the participants were between 30 years and 49 years old, while only 12.4% of the participants were 50 years and above. The result also shows that 58.6% of the participants were male and 46.6% of the respondents have household size of 2 to 4 persons and around

58.6% of them were in marriage relationship. In addition, most (64.0%) of the respondents had tertiary education, while only few (5.1%) have no formal education, and about 26.3% of them were low-income earners.

**Table 2: Socio-demographics characteristics of respondents**

Variables	Frequency N=1560	Percentage (%)
Gender		
Male	914	58.6
Female	646	41.4
Age		
<30	587	37.6
30-49	752	48.2
>=50	189	12.1
Not Reported	32	2.1
Marital Status		
Never Married Before	592	37.9
Married	896	57.4
No longer Married	62	4.0
No Response	10	0.6
Household Size in Persons		
1	166	10.6
2-4	731	46.9
4+	654	41.9
No Response	9	0.6
Religious Affiliations		
Christianity	1004	64.4
Islam	471	30.2
Others	80	5.1
No Response	5	0.3
Ethnic group		
Yoruba	1102	70.6
Others	457	29.3
No Response	1	0.1
Highest Educational Attainment		
No Formal Education	84	5.4
Primary School	108	6.9
Secondary / Technical School	395	25.3
Higher Institution of Learning	968	62.1
No Response	5	0.3
Employment Status		
Unemployed	173	11.1
Self employed	704	45.1
Employee of private/public sector organisation	439	28.1
Students and Others	244	15.6
Income level		
Low-income	410	26.3
Middle-income	223	14.3
High-income	483	31.0
No Response	444	28.5

### Types of GI in the neighbourhoods investigated

Table 3 shows the different types of GI identified in the neighbourhoods investigated. A careful examination of the result in Table 3 will reveal that the most common GI in the study area are those with green features followed by those with water features, those with tree features and others, respectively. It is also evident that Lagos Island has the most concentration of GI than the other neighbourhoods investigated in the study area.

**Table 3: Types of GI available in the neighbourhoods sampled**

Types of GI		Local Govt. Area of Neighbourhoods Sampled			
		Ikeja	Kosofe	Lagos Island	Surulere
S/N					
<i>A</i>	<i>GI with green features</i>				
1	Green roofs	√	√	√	×
2	City crop farms (urban agriculture)	×	√	√	√
3	Grasses	√	√	√	√
4	Sport Fields	√	√	√	√
5	Green parks	√	√	√	√
6	Green gardens	√	√	√	√
<i>B</i>	<i>GI with tree features</i>				
7	Forest	×	×	×	×
8	Street Trees	√	√	√	√
9	Horticulture	√	√	√	√
10	Woodland	√	×	√	×
11	Community Forest	×	×	×	×
<i>C</i>	<i>GI with water features</i>				
12	Flood Plains/wetland	√	√	√	√
13	Streams	√	√	√	√
14	Rivers	×	√	√	×
15	Lakes	×	×	√	×
16	Ponds	×	√	√	√
17	Fountains	√	×	√	√
<i>D</i>	<i>Other categories of GI</i>				
18	Open Spaces	√	√	√	√
19	Non-green parks	√	×	√	√
20	School yard	√	√	√	√
21	Wildlife Habitat	×	×	×	×
22	Cemetery	√	√	√	√

√ = Available; × = Not Available

### Residents' awareness of the different types of GI in the neighbourhoods

Of the six GI with green spaces identified, the highest proportion of the respondents were found to be mostly awareness of garden, parks, grasses, and sport fields in four Local Government Areas sampled. The result displayed in Table 4 shows that around 58.8%, 54.5%, 52.8% and 44.6% of the residents reported awareness of green parks, green gardens, grasses, and sport fields respectively in Ikeja Local Government Area. In Kosofe, the proportion of residents reporting GI awareness was 55.3%, 52.4%, 46.2% and 32.4% for green parks, green gardens, grasses, and sport fields, respectively, while in Lagos Island 58.6%; 54.4%, 51.0% and 37.8% were aware of green parks, green gardens, grasses and sport fields, respectively. The result in Table 4 also reveals that around 59.9%, 55.4%, 51.0% and 36.5% of the respondents in Surulere were reported to be aware of the existence of green parks, green gardens, grasses, and sport field, respectively, in their neighbourhoods.

**Table 4: Residents' awareness of green space GI**

GI Facilities	Awareness	Local Government Area				Total n(%)
		Ikeja n(%)	Kosofe n(%)	Lagos Island n(%)	Surulere n(%)	
Green roofs	NA	362(93.8)	361(94.3)	366(95.3)	363(94.5)	1452(94.5)
	A	24(6.2)	22(5.7)	18(4.7)	21(5.5)	85(5.5)
City Farms (Urban Agriculture)	NA	333(82.3)	314(82.0)	313(81.5)	312(81.2)	1272(82.8)
	A	53(13.7)	69(18.0)	71(18.5)	72(18.8)	265(17.2)
Grasses	NA	182(47.2)	206(53.8)	188(49.0)	188(49.0)	764(49.7)
	A	204(52.8)	177(46.2)	196(51.0)	196(51.0)	773(50.3)
Sport Fields	NA	214(55.4)	259(67.6)	239(62.2)	244(63.5)	956(62.2)
	A	172(44.6)	124(32.4)	145(37.8)	140(36.5)	581(37.8)
Green parks	NA	159(41.2)	171(44.7)	159(41.4)	154(40.1)	643(41.8)
	A	227(58.8)	212(55.3)	225(58.6)	230(59.9)	894(58.2)
Green gardens	NA	178(45.5)	185(47.6)	178(45.6)	174(44.6)	715(45.8)
	A	213(54.5)	204(52.4)	212(54.4)	216(55.4)	845(54.2)

A-Aware, NA-Not Aware

The result generally shows the residents sampled were more aware of green parks in Lagos Metropolis and this was most common in Surulere LGA. However, awareness of green roof was less common at both Surulere and Lagos Island.

Table 5 is a display of the respondents' level of awareness of tree features within their respective neighbourhoods. From result in Table 5, the respondents seem to be more aware of street trees compared to other tree features. This is confirmed by the result showing that around 57% of the respondents were aware of street trees in Ikeja LGA compared to Surulere where 53.6% were reported to be aware of street trees. In Lagos Island and Kosofe LGAs, 40.9% and 39.7% were found to be more aware of street trees, respectively. There were also very low percentages of the respondents who were aware of the presence tree features because the result reveals that Ikeja LGA for example only around 7.0%, 7.5%, and 7.3% of the

respondents claimed that they were aware of horticulture, woodland, and community forest, respectively. However, the same proportion (3.6%) of the respondents reported being aware of the existence of forests in Ikeja LGA compared to 23.0%, 19.8% and 13.0% reported in Kosofe, Lagos Island, and Surulere LGAs.

**Table 5: Residents' awareness of tree features GI**

GI Facilities	Awareness	Local Government Areas				Total N(%)
		Ikeja n(%)	Kosofe n(%)	Lagos Island n(%)	Surulere n(%)	
Forests	NA	372(96.4)	295(77.0)	308(80.2)	334(87.0)	1309(85.2)
	A	14(3.6)	88(23.0)	76(19.8)	50(13.0)	228(14.8)
Street trees	NA	166(43.0)	231(60.3)	227(59.1)	178(46.4)	802(52.2)
	A	220(57.0)	152(39.7)	157(40.9)	206(53.6)	735(47.8)
Horticulture	NA	359(93.0)	338(88.3)	338(88.0)	342(89.1)	1377(89.6)
	A	27(7.0)	45(11.7)	46(12.0)	42(10.9)	160(10.4)
Woodlands	NA	357(92.5)	325(84.9)	325(84.6)	352(91.7)	1359(88.4)
	A	29(7.5)	58(15.1)	59(15.4)	32(8.3)	178(11.6)
Community Forest	NA	358(92.7)	349(91.1)	347(90.4)	346(90.1)	1400(91.1)
	A	28(7.3)	34(8.9)	37(9.6)	38(9.9)	137(8.9)

A-Aware, NA-Not Aware

Table 6 shows the results on the respondents' level of awareness of water feature within their respective neighbourhoods. It is evident from the result (Table 6) that almost the same proportion of the respondents in the survey was aware of water features in the four LGAs investigated. However, the percentage of respondents who were aware of water feature was relatively very low across the four LGAs compared to other GI investigated in this study. For example, only 18.1% of residents were aware of fountains in Ikeja LGA, while 14.3% reported being aware of river in Kosofe LGAs.

**Table 6: Residents' awareness of water feature GI**

GI facilities	Awareness	Local Government Area				Total N(%)
		Ikeja n(%)	Kosofe n(%)	Lagos Island n(%)	Surulere n(%)	
Flood Plains	NA	372(96.4)	337(88.0)	342(89.1)	336(87.5)	1387(90.2)
	A	14(3.6)	46(12.0)	42(10.9)	48(12.5)	150(9.8)
Streams	NA	348(90.2)	326(85.1)	339(88.3)	331(86.2)	1344(87.4)
	A	38(9.8)	57(14.9)	45(11.7)	53(13.8)	193(12.6)
Rivers	NA	374(96.9)	328(85.7)	344(89.6)	347(90.4)	1393(90.6)
	A	12(3.1)	55(14.3)	40(10.4)	37(9.6)	144(9.4)
Lakes	NA	379(98.2)	351(91.6)	354(92.2)	368(95.8)	1452(94.5)
	A	7(1.8)	32(8.4)	30(7.8)	16(4.2)	85(5.5)
Ponds	NA	364(94.3)	365(95.3)	365(95.1)	362(94.3)	1456(94.7)
	A	22(5.7)	18(4.7)	19(4.9)	22(5.7)	81(5.3)
Fountains	NA	316(81.9)	356(93.0)	343(89.3)	339(88.3)	1354(88.1)
	A	70(18.1)	27(7.0)	41(10.7)	45(11.7)	183(11.9)

A-Aware, NA-Not Aware

The result on the distribution of the respondents according to their levels of awareness of the existence of other types of GI in the study area is shown in Table 7. For this category of GI, around 32.4% of the respondents indicated that they were aware of open spaces in Ikeja compared to Lagos Island, Surulere and Kosofe where 21.6%, 19.8% and 14.9% of them, respectively reported that they were aware of open spaces in their neighbourhoods.

**Table 7: Residents' awareness of other spaces GI**

GI facilities	Awareness	Local Government Area				Total N(%)
		Ikeja n(%)	Kosofe n(%)	Lagos Island n(%)	Surulere n(%)	
Other Open Spaces	NA	261(67.6)	326(85.1)	301(78.4)	308(80.2)	1196(77.8)
	A	125(32.4)	57(14.9)	83(21.6)	76(19.8)	341(22.2)
Non green Parks	NA	355(92.0)	351(91.6)	339(88.3)	350(91.1)	1395(90.8)
	A	31(8.0)	32(8.4)	45(11.7)	34(8.9)	142(9.2)
School Yards	NA	287(74.4)	283(73.9)	270(70.3)	284(74.0)	1124(73.3)
	A	99(25.6)	100(26.1)	114(29.7)	100(26.0)	413(26.7)
Wild Life habitat	NA	382(99.0)	377(98.4)	377(98.2)	378(98.4)	1514(98.5)
	A	4(1.0)	6(1.6)	7(1.8)	6(1.6)	23(1.5)
Cemetery	NA	370(95.9)	369(96.6)	369(96.3)	372(96.9)	1480(96.4)
	A	16(4.1)	13(3.4)	14(3.7)	12(3.1)	55(3.6)

A-Aware, NA-Not Aware

In the same vein, around 25.6%, 26.0%, 26.1%, and 27.9% of the respondents reported awareness of school yards in Ikeja, Surulere, Kosofe, and Lagos Island, respectively. However, a very low proportion (1.0%, 1.6%, 1.6% and 1.8%) of the respondents in Ikeja, Kosofe, Surulere and Lagos Island, respectively, were aware of wild life habitat. In summary, of the 22 GI facilities identified in the study area, a larger proportion of the participants in the survey were found to have more awareness of five GI: green garden, green parks, grasses, street trees, and sport fields than GI the study area.

### Socio-demographic predictors of awareness of GI in the neighbourhoods

The result in Table 8 shows the different residents' socio-demographic variables that predicted their level of awareness of GI in the study area. The regression model with  $F(30.982, 1529.018) = 1.838$ ,  $P < 0.000$  and  $R^2$  value (0.141), reveals that around 14.1% of the variance in the respondents' awareness of GI is accounted for in the current research.

**Table 8: Regression analysis of Socio-demographic predictors of awareness of GI**

Independent Variables/Predictors	Standardized Coefficients		DF	F	p
	Beta	Estimate of Standard Error			
Gender	0.007	0.016	1	0.184	0.668
Age	0.007	0.033	2	0.048	0.826
Marital Status	0.083	0.029	2	8.329	0.000*
Household Size	0.037	0.021	2	3.041	0.048*
Religious affiliation	0.021	0.019	2	1.212	0.298
Ethnic group	0.015	0.018	1	0.731	0.393
Highest education qualification	0.071	0.024	3	8.648	0.000*
Employment status	0.087	0.028	3	9.617	0.000*
Income level	0.040	0.023	2	3.059	0.047*

\*significant predictors

From the p-values in Table 8, it is evident that five of the nine socio-demographic variables investigated emerged as the significant predictors of awareness of GI in the survey. These variables are: marital status ( $p=0.000$ ), household size (0.048), education ( $p=0.000$ ), profession ( $p=0.000$ ) and income level (0.047). Examination of the  $\beta$  coefficients also reveals that respondents' employment status has the highest  $\beta$  coefficient of 0.087, and thus makes the most significant contribution in explaining the awareness level amongst the participants in the survey. This is followed by marital status (0.083), education (0.071), income level (0.040) and household size with a  $\beta$  coefficient of 0.037, respectively. However, respondents' gender, age, religion and ethnic origin appear not to be significant predictors of awareness of GI.

## DISCUSSION

Findings of this study reveal that all the four categories of GI identified in the literature were present in the study area. Specifically, 22 different types of GI were identified and a larger proportion of the participants in the survey were more aware of five of them: green garden, green parks, grasses, street trees and sport fields than all other types of GI identified in the study area. Notably, a higher proportion of the respondents in Ikeja were found to be aware of the different types of GI than their counterparts in the other three LGAs studied. Arguably, the fact that Ikeja is the administrative capital of Lagos State may have accounted for this result, and thus, this specific finding can be considered to be consistent with that by Conedera et al. (2015) who reported high prevalence of GI in urban Central Business Districts of the city of Bellinzona, the capital of Canton of Ticino, Southern Switzerland. Again, in support of previous studies (Byrne, Wolch & Zhang, 2009; Wolch et al, 2014) indicating that within cities, green spaces are not always equitably distributed and that access to GI is often highly stratified based on income, ethno-racial characteristics, age, gender and affordability, the current study reveals that in the four LGAs sampled, GI facilities are more prevalent in neighbourhoods in Ikeja and Lagos Island than in Kosofe and Surulere.

Result of the field observations by the researchers and presented in Table 3 show that GI associated with green features such as green parks and green gardens are more common in the study area. This finding did not come as a surprise because previous authors (Wolch et al, 2014; Laforteza et al, 2013) have noted that current

international efforts to preserve the natural environment have focused on the preservation of woodlands, bio-diversity, and planting of trees and gardens, which help to increase the vegetal species in urban areas. Although tree features were identified as the least common GI in the study area, many of the respondents were aware of these features but least aware of water features. This is probably because of the presence of street trees and practice of horticulture in the neighbourhoods. The relatively few respondents who were aware of water features may not be unconnected with the fact that the neighbourhoods investigated are not in close proximity to the several lagoons and waterfronts in Lagos State. In spite of the different types of GI identified, the relatively low number of respondents who claimed not to be aware of these facilities might be an indication that the existing stock of GI in the study area is not adequate and thus not noticeable by many of the participants in the survey.

Further analysis indicates that respondents' employment and marital status, education, income and household size emerged as socio-demographical factors that significantly influenced the participants' level of awareness of GI in the study area. This finding seems to provide support to previous studies (Cottrell, 2003; Shen & Saijo, 2008; Adegun, 2019; Venter et al, 2020) suggesting that certain aspects of individual personality had significant correlation with awareness of various types of features within their neighbourhoods. In fact, the emergence of socio-demographic variables such as education as predictors of awareness of GI in the study area is not a surprise because previous authors (Wall, 1995; Ewert & Baker, 2001) have shown that education is one of the most consistent predictors of environmental consciousness and that individuals with high levels of education tend to understand and care more about the environment than those of lesser educational attainment (Ewert & Baker, 2001; Silvennoinen et al, 2002; Üstün & Celep, 2007). This is probably because the differences in perception of any phenomena in the environment are influenced by the level of information an individual has about such (Wall, 1995). The study also provides support to the findings of previous studies (Üstün & Celep, 2007; Shen & Saijo, 2008) showing that income has a strong link to individual environmental awareness and concern.

The literature search for this research did not produce any study especially in Nigeria that examined the link between marital status, household size, and employment status on environmental awareness. However, the current study has shown that individual's marital status, household size and employment status are associated with awareness of GI. This means that awareness of GI is largely a function of one's level of educational and income, employment and marital status and household size. Contrary to findings of previous studies suggesting that there are strong associations between gender (Üstün & Celep, 2007; Shen & Saijo, 2008); age (Dietz, Stern & Guagnano, 1998; Cottrell, 2003) and environmental consciousness, the current study has shown that gender and age as well as religious and ethnic affiliations are not significant predictors of awareness of GI. It can therefore be inferred that there is no association between an individual's age, gender, religion, and ethnic origin/race on his/her level of awareness of the existence of green infrastructure among residents of Lagos Metropolis, Nigeria.



## CONCLUSIONS AND RECOMMENDATIONS

In this study residents' awareness of the different types of GI and its socio-demographic predictors in Lagos Metropolis, Nigeria were investigated. Based on the findings, the following conclusions are made. The first conclusion is that GI with green, tree, water features and other types of GI that cannot be classified under the aforementioned categories are available in the study area, but the predominant GI is that with green features. The second one is that in spite of the presence of GI, a low percentage of the respondents reported being aware of these in their neighbourhoods. The last conclusion is that the main socio-demographic factors that influenced the residents' level of awareness of GI in the study area were their employment, marital status, education, income levels and household size.

Findings of this research have implications that deserve mentioning. The first implication is that the proportion of residents who are genuinely aware of the existence of GI in their neighbourhoods is relatively low. This presents some levels of threats in the use, preservation and conservation of GI in the study area. To address this situation, there is a need for massive awareness campaigns among residents in the study area to improve their knowledge of GI, its benefits to the residents and the multifunctional role of GI in urban environmental sustainability agenda. Secondly, the study implies that since peoples' employment, marital status, education, income and household size have influence on their awareness of GI, general public awareness programmes may not produce the desired results, rather such programmes should be designed to meet the need of critical sections of the society with great potentials of yielding positive results. Thirdly, the study also implies that the stock of GI with tree features is relatively low in the study area. Therefore, it is recommended that the LASPARK should give more attention to the conservation/preservation of existing woodlands and planting of more trees in the study area. Summarily, the originality of this study is embedded in its unveiling the understanding about residents' awareness of Green Infrastructure types in a local setting like Lagos Metropolis Nigeria, compared to the popularity of GI studies and awareness in developed nations. It has contributed to knowledge by assisting to identify the specific socio-demographic factors that mostly influence the level of GI awareness among residents of Lagos Metropolis, Nigeria. This in turn will enable city managers and policy makers to critically consider and focus more on these identified factors in their attempts to increase the provision of GI facilities in Lagos, Nigeria and play less with other socio-demographic factors that do not influence the residence awareness of GI in the study area.

Added to the foregoing are the limitations of the current study. Findings of this study is limited to just four LGAs sampled in Lagos Metropolis. Hence, it is recommended that future study is required, and such study should consider adopting different research design and extending the geographic coverage to other neighbourhoods, LGAs in Lagos and other cities in Nigeria for more robust result. Secondly, based on the result of the regression model, only 14.1% of the socio-demographic predictors are counted for in this study, suggesting that more study is needed to include more respondents and variables.

## ACKNOWLEDGEMENTS

Authors deeply appreciate Lagos State Ministry of Environment for granting the ethical approval (MOE/OES/7250/52) for this study. All participants in the survey are also appreciated for their kind contribution to this research.

## REFERENCES

- Adegun, O. B. (2018) Residents' Relationship with Green Infrastructure in Cosmo City, Johannesburg. *Journal of Urbanism*, 11 (3), 329-346.
- Adegun, O. B. (2019) Green Infrastructure in Informal Unplanned Settlements: The case of Kya Sands, Johannesburg. *International Journal of Urban Sustainable Development*. <https://doi.org/10.1080/19463138.2019.1565412>.
- Adelekan, I. O. (2010) Vulnerability of poor urban coastal communities to flooding in Lagos, Nigeria. *Journal of Environment and Urbanization*, 22 (2), 433-450.
- Benedict, M. A. & McMahon, E. T. (2002) Green infrastructure: smart conservation for the 21st century. *Renewable Resources Journal*, 20 (3), 12-17.
- Biesta, G. & Osberg, D. (2007) Beyond representation: A case for updating the epistemology of schooling. *Interchange*, 38, 15-29.
- Byrne, J., Wolch, J. & Zhang, J. (2009) Planning for environmental justice in an urban national park? *Journal of Environmental Planning and Management*, 52 (3), 365-392.
- Conedera, M., Del Biaggio, A Seeland, K., Morettia, M. & Home, R. (2015) Residents' preferences and use of urban and peri-urban green spaces in a Swiss mountainous region of the Southern Alps. *Urban Forestry & Urban Greening*, 14, 139-147.
- Cottrell, S. P. (2003) Influence of Socio-demographics and environmental attitudes on general responsible environmental behavior among recreational boaters. *Environment and Behaviour*, 35, 347-375.
- Darling-Hammonda, L., Flook, L., Cook-Harveya, C., Barron, B. & Osher, D. (2020) Implications for educational practice of the science of learning and development. *Applied Developmental Science*, 24(2), 97-140, DOI: 10.1080/10888691.2018.1537791.
- Dietz, T. Stern, P. C. & Guagnano, A. (1998) Social structural and social psychological bases of environmental concern. *Environment and Behaviour*, 30 (4), 450-472.
- Dimopoulos, D., Paraskevolpoulos, S. & Pantis, J. (2009) Planning educational activities and teaching strategies on constructing a conservation educational module. *International Journal of Environmental and Science Education*, 4, 351-364.
- Dipeolu, A. A., Ibem, E. O., & Fadamiro, J. A. (2021) Determinants of residents' preferences for Urban Green infrastructure in Nigeria: Evidence from Lagos Metropolis. *Urban Forestry & Urban Greening*, 57. <https://doi.org/10.1016/j.ufug.2020.126931>.
- Dipeolu A. A. & Ibem E. O. (2020) Green Infrastructure Quality and Environmental Sustainability in Residential Neighbourhoods in Lagos, Nigeria. *International Journal of Urban Sustainable Development*, 12 (3), DOI: 10.1080/19463138.2020.1719500. Taylor & Francis.

- Dipeolu, A. A. (2017) Impact of Green Infrastructure on Environmental Sustainability in Selected Neighbourhoods of Lagos Metropolis, Nigeria. PhD Thesis, Department of Architecture, Federal University of Technology, Akure, Nigeria.
- Ewert, A. & Baker, D. (2001) Standing for where you sit: an exploratory analysis of the relationship between academic major and environment beliefs. *Environment and Behaviour* 33 (5), 687–707.
- Gökşen, F., Adaman, F. & Zenginobuz, E. Ü. (2002) On environmental concern, willingness to pay, and postmaterialist values: evidence from Istanbul. *Environment and Behavior*, 34 (5), 616–633.
- Gómez-Munoz, V. M., Porta-Gándarab, M. A. & Fernándezc, J. L. (2010) Effect of tree shades in urban planning in hot-arid climatic regions. *Landscape and Urban Planning* 94, 149–157.
- Hadzigeorgiou, Y. (2012) Fostering a sense of wonder in the science classroom. *Research in Science Education*, 42, 985–1005.
- Hartig, T., Evans, G.W., Jamner, L. D., Davis, D. S. & Gärling, T. (2003) Tracking restoration in natural and urban field settings. *Environmental Psychology*, 23, 109–123.
- Ibem, E. O. & Aduwo, E. B. (2013) Assessment of residential satisfaction in public housing in Ogun State, Nigeria. *Habitat International*, 40, 163–175. doi: 10.1016/j.habitatint.2013.04.001.
- Jardine, D., Clifford, P. & Friesen, S. (2003) *Back to the basics of teaching and learning*. Mahwah, NJ: Lawrence Erlbaum.
- Kaplan, S. & Kaplan, R. (1989) *The Experience of Nature: A Psychological Perspective*. Cambridge University Press, New York.
- Kuo, F. E. (2001) Coping with poverty: Impacts of environment and attention in the inner city. *Environment and Behaviour*, 33 (1), 5–34.
- Laforteza, R., Davies C., Sanesi G. & Konijnendijk, C. C. (2013) Green Infrastructure as a tool to support spatial planning in European urban regions. *International Journal of Forestry*, 6, 102–108.
- Ma, X. & Bateson, D. J. (1999) A multiple analysis of the relationship between attitude toward science and attitude toward the environment. *Environmental Education*, 31, 27–32.
- Moskell, C. & Allred, S. B. (2013) Residents' beliefs about responsibility for the stewardship of park trees and street trees in New York City. *Landscape and Urban Planning*, 120, 85– 95.
- Mullaney, J., Lucke, T. & Trueman, S. J. (2015) A review of benefits and challenges in growing street trees in paved urban environments. *Landscape and Urban Planning*, 134, 157–166.
- Naumann, S., McKenna D., Kaphengst, T. Anzaldúa, G. & Berry, P. (2011) *Design, implementation and cost elements of Green Infrastructure projects*. Final report. Brussels: European Commission.
- Oduwaye, L. (2009) Challenges of Sustainable Physical Planning and Development in Metropolitan Lagos. *Journal of Sustainable Development*, 2(1), 11–19. [www.ccsenet.org/journal.html](http://www.ccsenet.org/journal.html).
- Pakzada, P. & Osmonda, P. (2016) Developing a sustainability indicator set for measuring green infrastructure performance. *Procedia - Social and Behavioural Sciences*, 216, 68 – 79.

- Roeser, R. W. & Peck, S. C. (2009) An Education in Awareness: Self, Motivation, and Self-Regulated Learning in Contemplative Perspective. *Educ. Psychol.* 44(2), 119–136. doi: 10.1080/00461520902832376.
- Roy, S., Byrne, J. & Pickering, C. (2012) A systematic quantitative review of urban tree benefits, costs, and assessment methods across cities in different climatic zones. *Urban Forestry and Urban Greening*, 4 (11), 351–363.
- Sandstrom, U. F. (2002). Green Infrastructure planning in urban Sweden. *Journal Planning Practice Research*, 17 (4), 373–385.
- Schank, R. (2004) Making minds less well educated than our own. Mahwah, NJ: Lawrence Erlbaum.
- Seeland, K. & Nicolè, S. (2006) Public green space and disabled users. *Urban Forestry and Urban Greening*, 5, 29–34.
- Shrestha, S. L. (2009) Categorical regression models with optimal scaling for predicting indoor air pollution concentrations inside kitchens in Nepalese Households. *Nepal Journal of Science and Technology*, 10, 205–211.
- Shen, J. & Saijo, T. (2008) Re-examining the relations between socio-demographic characteristics and individual environmental concern: Evidence from Shanghai data. *Environmental Psychology*, 28, 42–50.
- Silvennoinen, H., Pukkala, T. & Tahvanainen, L. (2002) Effect of cuttings on the scenic beauty of a tree stand. *Scandinavian Journal of Forest Research*, 17, 263– 273
- Steg, L. & Vlek, C. (2009) Encouraging pro-environmental behaviour: An integrative review and research agenda. *Environmental Psychology*, 29, 309-317.
- Swedish International Development Cooperation Agency (Sida) (1999) Environmental Education Handbook. Unpublished.
- UN-HABITAT, (2014) The State of African Cities 2014: Re-Imagining Sustainable Urban Transitions. Nairobi: UN-Habitat.
- Üstün, B. & Celep, B. (2007) The connection between environmental awareness and socio-economic and cultural structure. *WIT Transactions on Ecology and the Environment*, 102, 623-631.
- Turner, A. G. (2003) Sampling strategies- Expert Group Meeting to review the draft handbook on designing of household sample surveys. Secretariat, Statistics Division. ESA/STAT/AC.93/2.
- Venter, Z. S., Krog, N. H., & Barton, D. N. (2020) Wall, G. (1995) General versus specific environmental concern: A Western Canadian case. *Environment and Behaviour*, 27, 294–316.
- Wals, A. (2011) Learning our way to sustainability. *Journal of Education for Sustainable Development*, 5, 177-186.
- World Health Organisation, (2016) Urban green spaces and health - a review of evidence. Retrieved from [http://www.euro.who.int/\\_data/assets/pdf\\_file/0005/321971/Urban-green-spaces-and-health-review-evidence.pdf](http://www.euro.who.int/_data/assets/pdf_file/0005/321971/Urban-green-spaces-and-health-review-evidence.pdf). on March 4, 2020.
- Wolch, J. R., Byrne, J. & Newell, J. P. (2014) Urban green space, public health, and environmental justice: The challenge of making cities 'just green enough' *Landscape and Urban Planning*, 125, 234–244.
- Zhang, Y., Hussain, A., Deng, J. & Letson, N. (2007) Public attitudes toward urban trees and supporting urban tree programs. *Environment and Behaviour*, 39 (6), 797–814.

Zuniga-Teran, A. A. Staddon, C., de Vito, L., Gerlak, A. K., Ward, S., Schoeman, Y., Hart, A. & Booth, G. (2020) Challenges of Mainstreaming Green Infrastructure in Built Environment Professions. *Journal of Environmental Planning and Management* 63 (4), 710-732.

## APPENDIX



Figure 3: Pictorial view of a green infrastructure site at Ojota, Kosofe, LGA, Lagos.



Figure 4: Pictorial view of a green garden at Ojota, Kosofe LGA, Lagos.



Figure 5: Pictorial view of street trees along Ikoyi road, Victoria Island, Lagos.



## BIM EDUCATION ONTOLOGY: TOWARDS A RESEARCH AGENDA FOR NON-INDUSTRIALISED ECONOMIES

Abdulazeez Abdulmumin<sup>1</sup>, B. A. Kolo<sup>2</sup>, Y. G. Musa-Haddary<sup>3</sup> and P. G. Chindo<sup>4</sup>

<sup>1</sup>*Department of Quantity Surveying, Federal University Birnin Kebbi, Kebbi State -Nigeria*

<sup>2,3,4</sup>*Department of Quantity Surveying, Ahamdu Bello University, Zaria – Nigeria*

BIM education is the cornerstone in addressing the shortage of BIM knowledgeable practitioners, currently experienced by the construction industry. To address this shortage, most industrialised economies are at the least, fine-tuning the incorporation of BIM education into higher education. BIM education ontology, though similar in nature, applies differently across the industrialised and non-industrialised economies, thus demanding differing approaches toward managing research gaps. While several studies on BIM education have been carried out in the non-industrialised economies, there is a lack of common frame of reference for managing research gaps in BIM education within these economies. By undertaking critical literature review, this paper explores the main themes within BIM education field of research. Relying on the theoretical research gap framework proposed by Miles (2018) to espouse the main considerations (in terms of concepts and properties) in BIM education research and their interdependencies, a conceptual model for BIM Education ontology is proposed. Based on the conceptual model, global considerations in BIM education centres around three main themes: curriculum, integration and implementation. Research gaps within curriculum are largely focused on insufficient curriculum, lack of unified method of assessment/evaluation, and lack of specific teaching methods; those within integration are inadequate collaboration between academia and industry; while those within implementation concentrates on lack of strategies on BIM implementation and competency deficits. Drawing upon the differentials between the industrialised and non-industrialised economies, the paper concludes by providing insights to newer research directions particularly targeted at addressing the challenges of incorporating BIM education into Higher Education in non-industrialised economies.

Keywords: BIM education, conceptual model, higher education, non-industrialised economy, ontology

### INTRODUCTION

Building information modeling plays important role in successful project delivery in construction industry. The BIM concepts provide bases for all construction

<sup>1</sup> abdulazeez.abdul@fubk.edu.ng; Tel. +2348062615822

<sup>2</sup> babaadamakolo@gmail.com

<sup>3</sup> gmusahaddary@gmail.com

<sup>4</sup> pcgangas@yahoo.com

stakeholders to shared one integrated model that contain both parametric and non-parametric information within a given project cycle (Ibrahim et. al., 2020; Kamari et.al., 2021). BIM allows early assessment of constructability, buildability, cost management, energy/structural analysis, and life cycle information of the physical asset (Matti et.al., 2015; Mohamed, A. 2019). Evidently, BIM ensure perfect modeling, construction, facility management and operations which thus increases the effectiveness and efficiency of construction industry as against the traditional methods of project delivery system (Alizadeh & Yitmen, 2018; Rosayuru et. el., 2019). However, continuously improvement and development of this concept and its practice among the industry stakeholders can accelerate its acceptance and adoption by the tertiary institutions in non-industrialised economies. In developed economies, statistics have shown that over 56% of tertiary institutions have integrate BIM education into their undergraduate programs in the built environmental courses (Sunil Suwal & Vishal Singh 2018; Jung et. al., 2019). Developing BIM education in the non-industrialised economies has also become imperative to the construction industry and educational institutions, particular in the mix of wide gap of both building and infrastructural deficits in most of the countries, this signifies need for innovation and personnel development who will fill the existing gaps of practice in the industry.

However, industrialised economies are independent state that have effective rate of industrialisation and individual income, while the developing economies are further subdivided into two the emerging and least developed economy countries (UNIDO, 2018; UNCTAD, 2019). The emerging economies are those countries that rapidly expanding, meaning that they are developing industry and wealth to compete on a global level. The least developed economies are weak countries which have a lot of obstacles in development, with low industrialization and low levels of human assets. These economies can be further subdivided base on the following characteristics namely; strong political well, strong economical resources, sound legal structure and natural resource or on other hand PESTEL can be used to describe them by the of the following political, economic, social, technology, environmental and legal framework . For the industrialised economies they both manage all most all the attribute mentioned above, while the non-industrialised economies might have only a few of these attribute.

BIM education importance cannot be overemphasis with huge benefits and impacts it has on construction industry. According to Swallow & Zulu (2019), BIM education provides a better market opportunity and a competitive advantage for student's and professional's equipped with BIM proficiency. Furthermore, the education sector is at the forefront of developing potential construction professional with BIM skills and knowledge to meet the industry's demand (Khosrowshahi & Ariyaci, 2012). The education has developed other success of vocational education training programmes to facilitate training other members of the construction industry to increase the workforce in the industry.

Globally, the researcher has concentrated on different areas in BIM education towards delivering the needed sought skills and knowledge in the industry. Some of these areas include curriculum, integration and implementation. Curriculum fields have subcategories which include content, development, learning and development. The curriculum consists of an outline of concepts to be taught to

students (Chong et al., 2017), contents are further requirements to be added in knowledge, skills, attitude and value transfer (Chong et al., 2017), Development requires steps-by-steps used to create positive improvements in courses offered by tertiary institutions (Oluwole, 2018), learning is that methods used in delivering required knowledge using different techniques to transfer knowledge (Justin & Alex, 2020). Integration of BIM has several approaches, researchers concentrate more on the synergy between the industry and academia as the most important tool required for collaboration between the two to achieve the needed knowledge transfer between the industry and academic environment (Amarnath et. al., 2016). However, implementation was classified into four by other researches to includes individual BIM (stand-alone), collaborative BIM (cross-discipline), Complementary BIM (integrating into existing courses) and capstone (project-based).

However, research work in BIM education, have attracted major interventions in research with attempted solutions to some of the identified problems in BIM education. This paper reported six (6) areas where the BIM education gave more attention as panacea to the problems. These includes lack of strategies in BIM implementation, deficits of competency, insufficient curriculum, inadequate collaboration and integration, non-effective teaching methods and improper methods of assessment. Despite, the extant work there is still low patronage of BIM education implementation among the non-industrialised economies. The paper concludes by providing insights to newer research directions particularly targeting at addressing the challenges of BIM education implementation into higher education in non-industrialised economies, using the existence evidence or strategies from the industrialised economies to propose solutions that could be achievable within the tenants of non-industrialised economies, looking at the peculiarities of the two economies. The following research questions are addressed;

- i. What is BIM education and its existence in educational practice?
- ii. What distinguish between industrialised and non-industrialised economies in relation to BIM education implementation in tertiary institutions?
- iii. What were the steps used by developed economies in integrating BIM education?
- iv. What are the strategies developed for BIM education implementation in tertiary institutions?

This is a step in addressing the broader research problem on how BIM education implementation can be improved to leveraged the current gaps in built environment programmes in tertiary institutions. The work is important in the sense that it opens up another chapter for evaluating existing studies on the methods and approaches used by the early adopters of BIM education to facilitates its replication in the non-industrialised economies based on their own characteristics. BIM education ontology is about the existence of this technology in the built environment and its epistemological understanding and practice in the tertiary institutions.



## LITERATURE REVIEW

### **Building information modelling education and its existence (ontology)**

According to Succar (2012) define BIM education as the process of learning the total concepts and practical knowledge of BIM technologies, protocol and workflows processes. BIM education are built on data management (technical), team collaboration (procedural) and risk management (regulatory topics). Xin & Aziz (2020) argued that BIM education starts with the diffusion of BIM awareness, followed by understanding the intellectual, concepts and mastering the BIM tools for application (Underwood, 2015). Succar further stressed that BIM education learning should considered as a triangle that comprises of the learner, the learning provider and learning spectrum.

Early research works have confirmed the existence of BIM education practice in tertiary institutions (Barison & Santos, 2010; Sacks & Pikas 2013; WU & Issa, 2014; Succar, 2013 and Onosen et al, 2020) studies thus includes BIM education framework, curriculum development and contents and collaboration. This indicate that the early adopters of BIM innovation into construction industry extended the knowledge to institutions that will produce BIM proficient graduate for the industry.

### **Distinction between industrialised and non-industrialised economies in relation to BIM education implementation in tertiary institutions**

Industrialised economy (or industrialized country, high-income country, more economically developed country (MEDC)) is a sovereign state that has a high quality of life, developed economy and advanced technological infrastructure relative to other less industrialized nations. Most commonly, the criteria for evaluating the degree of economic development are gross domestic product (GDP), gross national product (GNP), the per capita income, level of industrialization, amount of widespread infrastructure and general standard of living (UNIDO, 2018; UNCTAD, 2019). These are yardsticks used in measuring a countries development strength among nations. The lower the strength of the attribute mentioned above the more qualified the economies is to non-industrialised economy (UNIDO, 2018; UNCTAD, 2019).

BIM education acceptance and adoption by industrialised economies was as result of massive advancement in research and development, resource, manpower, experts, tertiary institutions and government support. However, developing economies like Nigeria and South Africa are two developing economies with difference in terms of aforementioned attributes that either act as a driver or deficiency to the development of the BIM education. Some of the attribute could difference per income, innovation integrations experts in the BIM field.

### **Steps used by developed economies in integrating BIM education**

There are several methods used by early adopters of BIM education to extend the BIM knowledge. Table one (1) have reported several studies on steps used in integrating BIM knowledge among the professionals and undergraduate students. (Sack & Pikas, 2013; Abdrid et al, 2016; Onosen & Adeyemo, 2020).

### **Strategies developed for bim education implementation in tertiary institutions**

Researchers have reported enough strategies to implement and teachers BIM education through share responsibility among construction industry stakeholders and the academia (). Other researcher like Huang (2018) argued that effective approach to BIM implementation in tertiary institutions may be achieved via BIM domestication in curriculum teaching the course as standalone, cross-discipline course and project courses/capstone project. However, all these effort made by industrialised economies to improve their industry and education by teaching BIM education, little is known on methods/approaches used by non-industrialised economies to implement BIM education

### **BIM education integration**

A literature review of the academic peered review articles was carried out to identify journal and conference papers that have attempted to address BIM education in higher education institutions (HEIs). All related cases on BIM education in built environment programmes in tertiary institutions were collected and analysed. The criteria for literature search and analysis process were described in section 1. Section two (2) presents the inferences from reviewed literature and the following outcomes were discussed and interpreted. section three (3) codification of BIM education classification and a conceptual framework for BIM education implementation was developed before conclusions and implications for further studies.

## **RESEARCH METHODOLOGY**

Literature review article provide a complete overview of literature linked to a theme/method and synthesis prior studies to support the foundation of knowledge (Justin & Alex, 2020). Systematic reviews are "rigorously designed and conducted literature reviews the aim to exhaustively search for, identify, and appraise the quality of article and syntheses all the high-quality research evidence in order to answer a specific question" (Philips, 2018; Theophilus, Emlyn & Irene, 2020).

This method enables the broad review of extant literature within the space of the research in a replicable and rigorous manner and, additionally, the results of systematic literature reviews have been contended to be as valued as those of any other evidence-based methodologies in educational interventions (Evans & Benefield, 2001; Phillips et al., 2018; Theophilus, Emlyn & Irene, 2020).

The methodology adopted for this research followed the recommendations of (Gough, 2007; Bearman et al., 2012 & Paul et al., 2020) for conducting systematic literature reviews. The initial step in this process is to explain the rationale of the review. The principal goal is to identify the implementation level of BIM in the education sector. The next step involved in the search for evidence from database. In turn, this stage was divided into several sub-stages: literature collection, literature filtration and literature synthetization. In order to do the literature collection, a document search was made from google scholar. The search was restricted to the last 7 years (2013–2020) in line with other recently published articles with emphases from initial publication from BIM (Soust-Verdaguer et al., 2017; Anand et al., 2017; Luque & Sanchez-Martin, 2019) on the other hand, the search was restricted to works published in English. All the documents analyzed

were peer reviewed to ensure the quality of the review (Chong et al., 2017; Luque & Sanchez-Martin, 2019).

The subsequent stage comprises of screening and filtering the articles obtained from the database, some references only touched in a very peripheral way the analyzed topic, others were uneconomical/falsefully reported (articles that were not about Building Information Modelling). Subsequently, the documents were read via the abstract, information was synthesized and tabulation, with main aspects dealt with the work, was realized.

Establishing the review question: The review question was developed to guide the direction of this study: what is the existing research work on BIM education in built environmental programmes. Defining the inclusion and exclusion criteria: All academic publications relating to BIM education in built environment from any country were included, but only those published in English language were considered. Academic publication refers to blind reviewed journal articles and conferences proceedings that report on research on any aspect of BIM education in tertiary institutions. Non-academic articles, and other trade publication sources and books were excluded on the ground that the quality of their contents could not be granted. Search strategy on articles was conducted on google scholar database to identify the suitable search terms. The Boolean operators were used as follows: ("Building information modeling" OR "BIM") AND ("Education" OR "learning" OR "Training") AND ("Built environment" OR "AEC" OR "Architecture, Electrical & Construction"). The articles returned from the search of database were 3500 references, the results were further downgraded based on the inclusion and exclusion to 150 articles. Finally, based on eligibility only 53 articles were used for the reviewed process as shown in Figure 1.

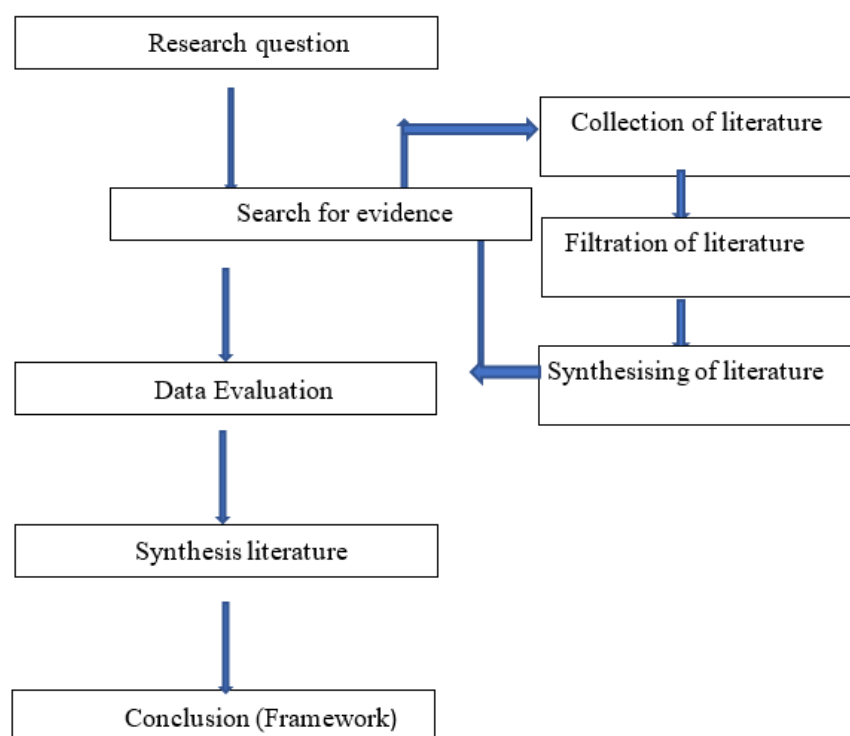

Fig. 1 Demonstration of review process based on Pawson et al., and Chong et al.,

Regarding the author's corresponding affiliation, table 1 shows that United State institutions had the high level of research works on BIM education. This clearly point out how time, knowledge and resources were expanded to realized the objective of BIM practice in the industry.

Based on the scrutiny of extant literature above, the following section analysed BIM education as catalyst to BIM implementation in the built environment programs of tertiary institutions.

## **ANALYSIS AND RESULTS**

From the relevant literature reviewed, BIM education articles centered on three main areas. These are the curriculum aspect, integration and implementation in the industrialised and non-industrialised countries.

Curriculum: the term curriculum refers to the lessons and academic content taught in a school or in a specific course or program (Brown, 2006). Therefore, BIM education curriculum should contain those relevant academic contents of all programs in specific and general domain within the built environment programs to enable smooth delivery of BIM lessons. In the industrialised economies several attempts were made to have more of specific curriculum than collaborative contents in the institutions (KOUIDER et. al., 2018). Curriculum literatures were reported with other sub-categories mainly development, contents, learning and delivery.

Curriculum in BIM education, for the early adopters of this innovation, they have made efforts to develop curriculum that will suits different discipline in built environment programs in the industrialised economies (KOUIDER et. al., 2018). The curriculum development and design are contextualized in nature in most of the countries, institutions and programs who had incorporate BIM in teaching and training. The curriculum in its nature is heterogenous because of its context base right from planning to delivery.

Some of the early researchers on BIM curriculum in AEC programs, (Barison and santos, 2010) classify BIM curriculum into introductory, intermediate and Advance stage to enable seamless delivery of BIM knowledge across the stages for optimum practice. Abdirad et.al., (2016) study BIM curriculum design in Architecture, engineering and construction programs in United State of America. These are universities or tertiary institutions with state of arts facilitates that motivate delivery of BIM with ease as a result of technology advancement and they also have experts to train the personnel on BIM operations.

BIM delivery methods are subject of discussion in both the industry and academia, though delivery used in teaching the curriculum contents been developed are classified based on requirement at the different levels (Oluwole, 2018). for instance, some delivery requires both practical and theoretical methodology. Previous studies have reported, face to face method, problem-based-learning, project-based-learning, collaborative learning using electronic facilitates. The delivery method adopt depends on the target audience in BIM processes.

BIM contents these are provided by extant research work and demand of the industry, which are develop over the time as the process of BIM evolves. Some of these contents are both specific and domain related (Oluwole, 2018).

BIM curriculum learning makes learning easier from progressively from simple to harder concepts/problems. This process is well documented as part of the requirement to achieve BIM education system in the industrialised economies (Barison and santos, 2010).

Integration of BIM into built environment programs, were specifically based on synergy between the academia and construction industry. This synergy is structured to enable the industry determine identify contents the academia needs to include in their curricula to enable delivery of BIM training in the tertiary institutions (MacDonald, 2012)

Implementation process varies from institutions to institutions, there are some basic requirements that determine the implementation process, the available programs in the built environment, collaborative institutions, availability of experts/professionals, facilitates, students and staff of the programs (KOUIDER et. al., 2018). Implementations among programs varies some have the following capstone/final project, cross discipline, collaborative and standalone courses.

**Table 1. Major descriptive faces of incorporated studies (n=53)**

S/N	Title	Problem solved	Reference	Year	Findings	Article Type	Location	Method
1	Teaching strategies in integrating BIM education for the QS courses in Malaysia higher education institution (2020)	Lack of strategies embedding BIM	Yap, Pei Xin and Aziz, Nur Mardhiyah	2020	lecture, workshop, collaboration, open learning platform and project-based learning	Journal	Malaysia	Case study
2	BIM educational framework for the QS students: Sri Lanka perspective	Missing skillsets/knowledge required for BIM usage	Anushka Rathnayake	2017	Framework developed for QS programs	Conference	Sri lanka	survey
3	Barriers to the incorporation of BIM into quantity surveying Undergraduate curriculum in Nigeria universities 2019	Missing factors for BIM incorporation	Solomon Olusola Babatunde, Damilola Ekundayo	2019	Culture, resistance, environment, staff security and high cost of implementation	Journal	Nigeria	survey
4	Developing a three-level framework for BIM education in construction management. 2018	Non-comprehensive BIM framework for BIM incorporation	Huang, Yilei	2018	IMAC was used	Journal	USA	Case study
5	A comparative diagnosis of student's proficiency in BIM construction related graduate programs in Brazil and USA 2018	Unclear extent of BIM adoption and its effectiveness	Silvio Burrattino Melhado, Aline Valverde Arrotoéia, Daniel Paes and Javier Irizarry	2018	Literature	Conference	Brazil	Case study
6	BIM curricula design in AEC education: A systematic review 2016	Lack of Comprehensive reviewed on BIM curriculum	Hamid Abdirad, Carrie S. Dossick	2016	Literature-based BIM curriculum	journal	USA	review
7	Knowledge, skills and functionality requirement for QS in BIM environment: An international Delphi study 2019	Deficit's skill/knowledge affect BIM practice	Abdullahi Babatunde Saka & Daniel W.M. Chan	2020	QS BIM skill requirement	Journal	Nigeria	Delphi survey
8	Assessment of strategies for BIM skills problem-based	Lack of prior assessment	Rahman, Rahimi A. and Ayer, Steven K	2017	using a single strategy might not be	Conference	USA	Review

	learning pedagogies 2017	strategies for skills in PBL			adequate for assessing BIM skills			
9	Integrated experiential learning-based framework to facilitates project planning in civil engineer and construction mgt courses 2019	insufficient research on upskilling students' competency	Jingxiao Zhang, Haiyan Xie, Klaus Schmidt, BoXia, Hui Li and Martin Skitmore	2019	Framework design to improve BIM delivery	journal	china	Case study
10	BIM practice: training and education of Nigeria QS's in preparation for BIM adoption 2020	Non-in-depth analysis of curriculum affects application	Onososen A.O. and Adeyemo	2020	Nonexistence of BIM in tertiary institution with single teaching introductory BIM education cross-disciplinary module or approach in QS education framework	Journal	Nigeria	Content analysis
11	Evaluation of BIM for QS: A review of teaching approaches 2019	Uncertainty of framework providing industry demand	Suhaida S.K, Nurul Aini Osman, Nadeera Abdul Razak, and M A Shazwan	2019		Conference	Malaysia	review
12	Probing BIM education in construction engineering and mgt programs using industry perception 2013	Deficient BIM courses in CM undergraduate program	Namhun Lee and Donna A. Hollar	2013	Perceptions on education	Conference		survey
13	Gearing up academics for collaborative BIM education 2015	Scarcity of BIM training support to academics	Carol K.H. Hon, Ezezi Utiome, Robin Drogemuller, Robert Bob Owen, Madhav Nepal, Jason Gray, Vaughan Coffey	2015	Teaching and learning initiated will break the barrier for non-compliance to BIM collaboration	Conference	Australia	Pilot study
14	Sustainable BIM based construction engineering education curriculum for practice-oriented training 2019	inadequate AEC curricula affects BIM skills	Lee S, Lee J, Ahn Y	2019	A suitable curriculum was developed to suit the korean BIM requirement	Journal	Korea	
15	Curriculum to prepare AEC students for BIM enabled globally distributed projects 2019	Challenges of curriculum on multidisciplinary global project	Anne Anderson, Carrie Sturts Dossick & Laura Osburn	2019	Findings on how different students collaborate on BIM project	Journal	USA	PILOT STUDY
16	AEC student's perceptive in the learning process of CAD & BIM (2016) BIMAS	Challenges of techniques to teach CAD & BIM	Gulbin Ozcan-Deniz	2016	Findings reveals important of learning BIM tools at both undergraduate and graduate	BIM symposium	USA	survey
17	Advancing BIM knowledge through engaging stakeholders at local and regionals 2016	challenges of KSA to deliver BIM	Gonzalez Michael Angel	2016	Emphasis on collaboration to achieve breakthrough in BIM education	BIM symposium	USA	concept
18	Integrating BIM across an undergraduate const. mgt curriculum experiential learning through a Tiny house project 2016	Deficient pedagogical delivery affects students learning	Wei Wu and Brad Hyatt	2016	Establish the important of pedadogical teaching and experiential learning by students	BIM symposium	USA	Case study
19	Development of a peer review-based activity to impose students BIM process mapping understanding 2016	Challenge students encounter in mapping BEP	Michael Beauregard, Suleiman Alsafouri and Steven K. Ayer	2016	Establish pedadogical approach to team work among students in collaborative studies	BIM symposium	USA	Case study
20	BIM skills for career success 2016 BIMAS	Difficult synergy of educator and industry affects manpower	Rahimi A. Rahman, Suleiman Alsafouri and Steven K. Ayer	2016	Chances of BIM experts becoming project manager in BIM project	BIM symposium	USA	survey
21	Developing an international framework for BIM education in the high education sector 2016	Unsettled dilemma on mode of BIM incorporation	Shelbourn, M.A.,Macdonald, J., and Mills, J.	2016	IMAC framework was tested and result shows that more is needed to implement BIM in Universities in Australia	BIM symposium	Australia	Mixed method

22	Knowledge transfer into a BIM course through technology driven solutions for real world construction projects	Difficulties in learning using traditional education	Marcel Maghiar	2016	Establish the importance of collaboration with industry to drive real practical solution to BIM implementation	BIM symposium	USA	Case study
23	Collaboration with BIM an experiential learning case 2016	Major programs lack strategy to embed BIM	Julide Bozoglu et. al.	2016	Establish importance of industry collaboration in BIM delivery	BIM symposium	USA	Case study
24	Enhancing BIM education experiences with integrated keystroke capture software	Difficult students face assimilating BIM training	Nathan Blinn and Raja R. A. Issa	2016	Establish the importance of screencast technology in lectures by students (Autodesk)	BIM symposium	USA	Survey 29 students
25	Incorporating BIM into the preconstruction services course at BYU 2016	Inadequate space hours affect BIM incorporation	Kevin R. Miller	2016	Effective system of BIM integration into existing QS courses	BIM symposium	USA	CASE study
26	Integration of BIM (3D CAD) throughout the industrial construction education track 2016	Shortfall of 3D industry-level knowledge affect BIM	Carol J. Friedland et. al.,	2016	Develop a framework to incorporate 3D modeling in industrial education	BIM symposium	USA	framework
27	BIM curriculum development	lacks of well-developed AEC BIM curriculum	Richard Faust	2016	Researcher gave an insight to development of BIM curriculum	BIM symposium	USA	Concept
28	BIM implementation at Building systems course @ United Arab Emirates university	Deficiency in harmonizing traditional-BIM courses	Jose Ferrandiz	2016	Incorporating 3D modeling into architecture programs using PBL	BIM symposium	UAE	
29	The development of a BIM enabled curriculum: planning freshman year	Inadequate strategies to incorporate traditional-BIM courses	Scott P. Vlasek	2016	Proposed models, management and graphics courses for beginners	BIM symposium	USA	
30	Benefits of inter-institutional collaboration in the delivery of BIM education in Ireland. Reflections of an Irish master's program	Challenges of inter-institutional collaboration in BIM master program	Alan V. Hore et. al.,	2016	There benefits if well supported by all stakeholders at both industries, professional and the academia. Overall is govt enforcement	BIM symposium	Ireland	Survey
31	Preliminary review of BIM tertiary education in the province of Ontario	Lack competency to train graduate level	Christopher J. Willis	2016	Findings is that non-existent of BIM education in Ontario university	Conference	Ontario, Canada	Case study
32	Education Needs to Support Architecture, Engineering, and Construction Collaboration Using Building Information Modeling 2019	Bottleneck in accepting BIM by AEC	Rostam, D. M.	2019	Collaborative culture needed by players via undergraduate programs to achieve effective BIM practice	Journal	UK	Survey
33	Building Information Management (BIM) education in the Dominican Republic: An empirical study, 2017	Difficult task with provision of BIM education	Ana Karina Silverio Rodriguez et. al.,	2017	They lack of experts and BIM education, but currently depend on BIM software training	conference	Dominica n Republic	Interview (9 professional s)
34	Building Information Modelling Uptake: Tool Training in Nigerian University	Slow uptake of BIM in universities	Hamma-Adama M. et. al.,	2018	This reveals a clear setback in the tools training to carter for the BIM uptake in the country	Journal	Nigeria	Survey
35	BIM for Quantity Surveying: An Investigation into its Adoption and Education in Hong Kong 2019 unpublished	Insufficient BIM level and its deficiency	Calvin KEUNG	2019	BIM models in practice not sufficient for QS task and BIM education found only in basic course but lacking at advanced and	Unpublishe d thesis	Hong Kong	Mixed method

36	Toward deep impacts of BIM on education 2019	no common/finite set of symbols in BIM	Ziga Turk and Andreja I. S.	2019	interdisciplinary level. T-shaped method of integration was suggested for BIM engineering programs	Journal	Slovenian	Concept
37	Building Information Modelling (BIM) Educational Framework for Quantity Surveying Students: The Malaysian Perspective	Insignificance Skills/knowledge required for BIM usage	Kherun N. Ali et. al.,	2016	Framework was developed based IMAC for BIM education in QS program	journal	Malaysia	Focus group discussion
38	BIM education - Case New Zealand	Lack of BIM educational in NZ	Taija Puolitaival et. al.,	2017	knowledge and skill gaps among faculty, crowded curricula, and limited time for development work Teaching BIM in two stage at secondary and tertiary institution, to reduce the spatial load in the university	Conference	New Zealand	Case study
39	FRAMEWORK FOR INTEGRATING BIM EDUCATION IN THE CURRICULUM OF AEC PROGRAMS 2019	Complex challenges affect quality of BIM	Oluseye Olugboyege and Abimbola Windapo	2019	Identify some implementation strategies	conference	South Africa	Concept paper
40	A framework for Building Information Modeling implementation in engineering education	lack of guide to BIM implementation	Conrad Boton, Daniel Forgues, and Gilles Halin	2018	IMAC framework was developed to assess the BIM education	journal	Canada	Case study
41	A Framework for Collaborative BIM Education across the AEC Disciplines BIM (Building Information Modeling) Education Program in KSA: A Case Study of BIM program at Prince Sultan University	Shortage of BIM professionals affect the training	Jennifer A. Macdonald	2011	BIM implementation strategy was developed for PSU	Conference	Australia	Framework
42	Conceptual Framework for the Use of Building Information Modeling in Engineering Education 2019	Scarcity of teaches to deliver BIM training	TaeYeua Yi1 and SukHee Yun	2018	Framework for teaching BIM	Conference	KSA	Case study (PSU)
43	Implementing a Vertically Integrated BIM Curriculum in an Undergraduate Construction Management Program 2014	Inadequacy of teaching methods in BIM education	FRANCISCO ZAMORA-POLO et. al.,	2019	It improves the student pruriency in information management in BIM	Journal	Brazil	Review
44	BIM Education and Recruiting: Survey-Based Comparative Analysis of Issues, Perceptions, and Collaboration Opportunities 2014	Challenges of mainstream BIM curriculum in CM	Arundhati Ghosh et.al.,	2014	There is improvement in BIM implementation & adaptation, but gap exists in growth and incentive	Journal	USA	Survey
45	Overview of BIM education in the field of construction management at the Faculty of Civil Engineering in Košice and the Faculty of Civil Engineering in Zagreb, 2017	Deficits of Gap between students and workforce	Wei Wu and Raja R A. Issa	2013	Findings reported that only stand-alone program is been run in the faculty	Journal	USA	Survey
47	Building Information Modelling in Tertiary Construction Project Management Education: A Programme-wide Implementation Strategy, 2013	Insufficiency of BIM courses in CE	Sonja Kolarić et. al.,	2017	Developed a process that binds the people and process of BIM practice with the technology as supportive	Conference	Croatia and Slovakia	Case study
48	Incorporating BIM in the Final Semester Undergraduate Project of Construction 7	Low uptake of BIM in HEI's	Perry Forsythe, Julie Jupp & Anil Sawhney	2013	Perception of the study groups were positive based on the activities	Journal	Sydney	Case study
49		Missing of BIM final year project	Wang L., Yan X., Fan B., Jin R., Yang T., and Kapogiannis G.	2020		Journal	China	Case study



	Management-A Case Study in Fuzhou University, 2020				involved in BIM practice at the final semester projects			
50	Fundamental of implementing BIM in architecture education at the graduate school level, 2020	Lack of guideline to establish BIM @ graduate level	Kausar, M., Mahanta, N. R., & Samuel, A.	2020	Evaluates the teaching methods before considering BIM integration	Conference	UAE	Case study
51	Use of BIM at higher learning institutions: Evaluating the level of implementation and development of BIM at built environment schools in South Africa. 2018	Uncertainty on level of BIM spectrum implementation	Pillay, N., Musonda, I. & Makabate, C	2018	Findings reported are 2D and 3D CAD design were taught in some universities	Conference	South Africa	Questionnaire survey
52	Project Based Learning with Implementation Planning for Student Engagement in BIM Classes, 2018	Insufficient research on BIM capstone-real projects	Jingxiao Zhang, Haiyan Xie and Hui Li	2018	It provides a sound foundation for the instruction of BIM education in university teaching	Journal	China	Case study
53	University-industry collaboration for BIM education: Lessons learned from a case study, 2020	Missing collaboration between industries and Universities	Ke Chen, Weisheng Lu and Jing Wang	2020	Students learn more in collaboration with industry in both practical and theory	Journal	Hong Kong	Case study

Table 1 present the major descriptive of major findings incorporated in the study. The BIM education ontology, as reported due exists. The epistemological understanding of the knowledge of BIM is what matters to improve the level of BIM implementation in the non-industrialised economies. From the table above studies have shown the real existence of BIM in the developed economies, with strategic approaches to its implementation. The setback to the developing and emerging economies will be from state of art facilities in technology, culture, structure of construction industry, personnel and experts.

Table 2, reveals the problem solved; these problems can be further categories into six (6) headings.

**Table 2: Problems solved in extant research**

Problems	Authors
Lack of strategies	1,4,23, 38,39, 40, 48,34,50
Insufficient curriculum	5,6,10,12,14,15,27,35,44,46,47,51
Serious gap in collaboration	20,21,30,45,
Lack of unified method of evaluation/assessment	8,49,54
Inadequate teaching methods	16,18,22,24
Competency Deficits	2, 7,9,13,17,19,26,31,33,37,41,42

### A conceptual framework for BIM education

BIM education implementation framework was proposed from the studies above as an insight for built environment programs in developing countries.

### Conceptual framework of BIM education for High Education in Non-industrialised Economy

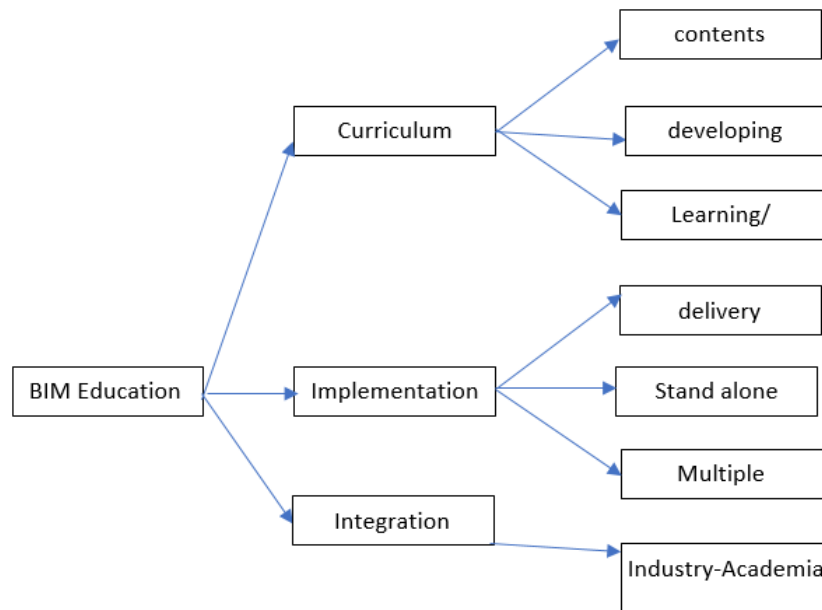

Curriculum development, content, learning and delivery these variables are very important when it comes to BIM education as elaborated by previous researcher in industrialised economies, the global approach might be challenging to the non-industrialised economies due to some difference in development level, infrastructure, organization nature etc. The method to adapt might be from understand the current system of non-industrialise economies compare with advance countries then identify those gaps and abilities which can serve as a stepping stone in initiating BIM education into the existing programs. The development takes into account developing the content, objective of contents, method of delivery, (Knowledge, skills and abilities = competency) and assessment/evaluation. These variables are most important to BIM education implementation.

Integration, the developed nation achieved the milestone by full collaboration with the industry stakeholders, who demand for the BIM service and the academia supply the needed manpower to deliver BIM in the construction industry. Several case studies have been reported with exchange of knowledge between the industry experts and high education institutions via transfer of knowledge and practical to the students who will later take over the industry after graduation.

Implementation is very important variable to consider at high education institutions; even though lack of strategies and competencies are among major challenges hindering most of the higher institutions in leveraging on BIM implementation into their respective programs.

The study will further investigate the major difference of industrialise economies and non-industrialised economies in attributes to empower the emerging economies from domesticating in educational sector.

## DISCUSSION AND CONCLUSION

The literature is almost unanimous on the importance of understanding the early adopter of BIM education as a catalyst for emerging economies to flow suits to attain the level of industry growth by the developed countries. This confirmed the submission by Barison and Santos (2010) that BIM education can be achieved by proper diffusing the knowledge into various programmes in tertiary institutions.

The multi-dimensional approach to BIM education globally requires careful evaluation, to determine a realistic approach to BIM in non-industrialised economies. The approaches are not homogenous in nature, they are heterogenous because all developed countries have their different methods used in BIM education development processes.

The study has highlighted a conceptual framework based on available theory on BIM education to serve as starting point into mapping process for BIM education implementation in Nigerian tertiary institutions.

However, for a developing country like Nigeria, a suitable study approach is required to plan strategic methodology for incorporating BIM education into higher education of tertiary institutions, who are the bridge to the construction industry. This preliminary study to initiate doctoral research has review literature identified with BIM education for built environment.

## REFERENCES

- Babatunde, S. O., & Ekundayo, D. (2019), "Barriers to the incorporation of BIM into quantity surveying undergraduate curriculum in the Nigerian universities", *Journal of Engineering, Design and Technology*, Vol. 17 No. 3, pp. 629-648. <https://doi.org/10.1108/JEDT-10-2018-0181>
- Yap, Pei Xin & Aziz, Nur Mardhiyah (2020) Teaching strategies in integrating BIM education for the quantity surveying courses in Malaysian higher education institution. *Malaysian Construction Research Journal*, 9 (1). pp. 126-132. ISSN 1985-3807
- Huang, Yilei (2018), "Developing a Three-Level Framework for Building Information Modeling Education in Construction Management "Universal Journal of Educational Research, v6 n9 p1991-2000 2018 ISSN: ISSN-2332-3205
- Silvio Burrattino Melhado, Aline Valverde Arrotéia, Daniel Paes and Javier Irizarry (2018), " A comparative diagnosis of students 'proficiency in BIM in construction-related graduate programs in Brazil and in the United States "DOI: 10.1109/ACCESS.2020.3042662
- Hamid Abdirad, Carrie S. Dossick (2016). BIM curriculum design in architecture, engineering, and construction education: a systematic review. *Journal of Information Technology in Construction (ITcon)*, Vol. 21, pg. 250-271, <http://www.itcon.org/2016/17>
- Rahman, Rahimi A. and Ayer, Steven K (2017), "Assessment Strategies for Building Information Modeling Skills in Problem-Based Learning Pedagogics" 6th conference proceedings CSCE/CRC International Construction Specialty ConferenceAt: Vancouver, Canada

- Jingxiao Zhang, Haiyan Xie, Klaus Schmidt, BoXia, Hui Li and Martin Skitmore (2019). "Building information modeling: Systematic course development for undergraduate construction students" *Journal Professional Issues Engineering Education Practice* 145(4) DOI: 10.1061/(ASCE)EI.1943-5541.0000421
- Onososen A. O., & Adeyemo, M. O. (2020). BIM Practice: Training and Education of Nigerian Quantity Surveyors in Preparation for BIM Adoption; *PM World Journal*, Vol. IX, Issue II, February.
- Suhaida S. K., Nurul Aini Osman, Nadeera Abdul Razak., & M. A. Shazwan, (2019), "Evaluation of BIM Education for Quantity Surveying: A Review of Teaching Approaches" in *Social Sciences on Sustainable Development for World Challenge: The First Economics, Law, Education and Humanities International Conference*, *KnE Social Sciences*, pages 546–557. DOI 10.18502/kss.v3i14.4336
- Lee, Sanghyo; Lee, Joosung; Ahn, Yonghan (2019). "Sustainable BIM-Based Construction Engineering Education Curriculum for Practice-Oriented Training" *Sustainability* 11, no. 21: 6120. <https://doi.org/10.3390/su11216120>
- Anne Anderson, Carrie Sturts Dossick & Laura Osburn (2019): Curriculum to Prepare AEC Students for BIM-Enabled Globally Distributed Projects, *International Journal of Construction Education and Research*, DOI: 10.1080/15578771.2019.1654569
- Christopher J. Willis (2017). "A Preliminary Review of Building Information Modeling (BIM) Tertiary Education in the Province of Ontario" 53rd ASC Annual International Conference Proceedings associated Schools of Construction, Seattle, Washington, USA.
- Rostam, D. M. (2019) "Education Needs to Support Architecture, Engineering, and Construction Collaboration Using Building Information Modeling", *ARO-THE SCIENTIFIC JOURNAL OF KOYA UNIVERSITY*, 7(2), pp. 53-62. doi: 10.14500/aro.10604.
- Ana Karina Silverio Rodriguez, Subashini Suresh, Suresh Renukappa, and David Heesom (2017). Building Information Management (BIM) education in the Dominican Republic: An empirical study. *Proceeding of International Conference on Sustainable Futures (ICSF) 26 – 27 November 2017, Bahrain.*
- Hamma-Adama M., Kouider T., & Salman H. (2018). Building Information Modeling Uptake: Tool Training in Nigeria. *Open Science Journal* 3(3). DOI: 10.23954/osj. v3i3.1728.
- Calvin Keung (2019). BIM for Quantity Surveying: An Investigation into its Adoption and Education in Hong Kong. Unpublished research report. The Hong Kong Institute of Surveyors Quantity Surveying Division. Retrieved from [https://www.hkis.org.hk › RC1718036\\_report](https://www.hkis.org.hk › RC1718036_report)
- Kherun N. Ali, Nur E. Mustaffa, Quek J. Keat, Wallace I. Enegbuma (2016). Building information modelling (BIM) educational framework for quantity surveying students: The Malaysian perspective. *Journal of Information Technology in Construction (ITcon)*, Special issue: 9th AiC BIM Academic Symposium & Job Task Analysis Review Conference, Vol. 21, pg. 140-151, <http://www.itcon.org/2016/9>
- Taija Puolitaival, Tina Booth, Ali Ghaffarian Hoseini and Kenneth Sungho Park (2017). BIM education - Case New Zealand. *Proceeding AUBEA 2017: Australasian Universities Building Education Association Conference 2017, Volume 1, 2017, Pages 210–218, New Zealand.*

- Oluseye Olugboyega and Abimbola Windapo (2019). Framework for Integrating BIM Education in The Curriculum of AEC Programs. Proceeding of 10th SACQSP International Research Conference 2018, Rosebank, South Africa, 30 September – 10 October.
- Jennifer A. Macdonald (2011). A Framework for Collaborative BIM Education across the AEC Disciplines. Proceeding 37th Annual Conference of the Australasian Universities Building Educators Association (AUBEA) The University of New South Wales, Australia.
- TaeYeua Yi1 & SukHee Yun (2018). BIM (Building Information Modeling) Education Program in KSA: A Case Study of BIM program at Prince Sultan University. Proceedings International conference of Computer and Electrical Engineering (ICCEE) E3S Web of Conferences 65, 04004 (2018) <https://doi.org/10.1051/e3sconf/20186504004>.
- Arundhati Ghosh, Kristen Parrish Ph.D. & Allan D. Chasey Ph.D., PE (2015) Implementing a Vertically Integrated BIM Curriculum in an Undergraduate Construction Management Program, International Journal of Construction Education and Research, 11:2, 121-139, DOI: 10.1080/15578771.2014.965396.
- Wu, Wei & Issa, Raja. (2013). BIM Education and Recruiting: Survey-Based Comparative Analysis of Issues, Perceptions, and Collaboration Opportunities. Journal of Professional Issues in Engineering Education and Practice. 140. 10.1061/(ASCE)EI.1943-5541.0000186.
- Perry Forsythe, Julie Jupp & Anil Sawhney (2013) Building Information Modelling in Tertiary Construction Project Management Education: A Programme-wide Implementation Strategy, Journal for Education in the Built Environment, 8:1, 16-34, DOI: 10.11120/jebe.2013.00003.
- Sonja Kolarić, Tomáš Mandičák, Mladen Vukomanović and Peter Mesároš (2017). Overview of BIM Education in The Field of Construction Management at The Faculty of Civil Engineering in Košice and The Faculty of Civil Engineering in Zagreb. Proceedings of scientific papers 1-8.
- Wang L., Yan X., Fan B., Jin R., Yang T., and Kapogiannis G. (2020). "Incorporating BIM in the Final Semester Undergraduate Project of Construction Management-A Case Study in Fuzhou University." KSCE Journal of Civil Engineering, In Press, Accepted for publication on 6 Apr 2020.
- Kausar, M., Mahanta, N. R., & Samuel, A. (2020). Fundamentals of implementing Building Information Modeling (BIM) in architectural education at the graduate school level. 2020 Advances in Science and Engineering Technology International Conferences (ASET). doi:10.1109/aset48392.2020.9118360.
- Pillay, N., Musonda, I. & Makabate, C. (2018). Use of BIM at higher learning institutions: Evaluating the level of implementation and development of BIM at built environment schools in South Africa. Conference proceedings Aubea 2018- Educating building professionals for future: innovation, technology, sustainability. At: Singapore Volume: 2.
- Taija Puolitaival & Linda Kestle (2018). Teaching and learning in AEC education – the building information modelling factor. Journal of Information Technology in Construction (ITcon), Vol. 23, pg. 195-214, <http://www.itcon.org/2018/10>.
- Jingxiao Zhang, Haiyan Xie and Hui Li (2018). Project Based Learning with Implementation Planning for Student Engagement in BIM Classes. International Journal of Engineering Education Vol. 35, No. 1(B), pp. 1–13, Great Britain.

- Ke C., Weisheng L., & Jing W. (2020). University–industry collaboration for BIM education: Lessons learned from a case study. *Industry and Higher Education* 1–9, sagepub.com/journals-permissions, DOI: 10.1177/0950422220908799.
- Ibrahim Y. W., Geoffrey Q. S., Robert O. & Stephen A. (2020). Modelling the critical risk factors for modular integrated construction projects, *International Journal of Construction Management*, DOI: 10.1080/15623599.2020.1763049.
- Kamari, A., Paari, A., & Torvund, H. O. (2021). "BIM-Enabled Virtual Reality (VR) for Sustainability Life Cycle and Cost Assessment" *Sustainability* 13, no. 1: 249. <https://doi.org/10.3390/su13010249>.
- Matti K. Tauriainen, Jari A. Puttonen, Arto J. Saari (2015). The assessment of constructability: BIM cases. *Journal of Information Technology in Construction (ITcon)*, Special Issue: ECPPM 2014, Vol. 20, pg. 51-67, <http://www.itcon.org/2015/4>.
- Mohamed, A. (2019). The implementation of building information modeling (BIM) towards sustainable construction industry in Egypt "The pre-construction phase" [Master's thesis, the American University in Cairo]. AUC Knowledge Fountain. <https://fount.aucegypt.edu/etds/508>.
- Alizadeh S., & Yitmen, İ. (2018). Modeling and analysis of the impact of BIM-based field data capturing technologies on automated construction progress monitoring. *International Journal Civil Engineering* 16, 1669–1685. <https://doi.org/10.1007/s40999-018-0320-1>.
- Rosayuru, H. D. R. R., Waidyasekara, K. G. A. S., & Wijewickrama, M. K. C. S. (2019). Sustainable BIM based integrated project delivery system for construction industry in Sri Lanka, *International Journal of Construction Management*, DOI: 10.1080/15623599.2019.1645263.
- Sunil S., & Vishal S. (2018) Assessing students 'sentiments towards the use of a Building Information Modelling (BIM) learning platform in a construction project management course, *European Journal of Engineering Education*, 43:4, 492–506, DOI: 10.1080/03043797.2017.1287667.
- Jung, Y., Park, K., & Ahn, J. (2019). "Sustainability in Higher Education: Perceptions of Social Responsibility among University Students" *Soc. Sci.* 8, no. 3: 90. <https://doi.org/10.3390/socsci8030090>.
- Swallow, M. & Zulu, S. (2019). "Students 'awareness and perception of the value of BIM and 4D for site health and safety management", *Journal of Engineering, Design and Technology*, Vol. 18 No. 2, pp. 414-430. <https://doi.org/10.1108/JEDT-07-2019-0174>.
- Chegu Badrinath, A., Chang, Y. & Hsieh, S. (2016) A review of tertiary BIM education for advanced engineering communication with visualization. *Visualization in Engineering* volume 4, 9. <https://doi.org/10.1186/s40327-016-0038-6>
- Theophilus O., Emlyn W., & Irene L. (2020). Conceptualising Building Information Modelling for Construction Education. *Journal of Civil Engineering and Management*, ISSN 1392 3730/eISSN 1822-3605, 2020 Volume 26 Issue 6: 551–563. <https://doi.org/10.3846/jcem.2020.12918>.
- Brown, D. F. (2006). It's the curriculum, stupid: There's something wrong with it. *Phi Delta Kappan*, 87(10), 777–783.

Kouider, T., Salman, H. & Paterson, G. 2018. Developing and embedding a BIM curriculum in build environment courses: the RGU experience. In Kouider, T. and Alexander, G. (eds.) Proceedings of the 7th International congress on architectural technology (ICAT 2018): architectural technology at the interfaces, 14-17 June 2018, Belfast, UK. Aberdeen: Robert Gordon University, pages 155-172.

Oluwole, A. O. (2018). Promoting student commitment to BIM in construction education. *Engineering, Construction and Architectural Management* Vol. 26 No. 7, 2019pp. 1240-1260© Emerald Publishing Limited0969-9988. DOI 10.1108/ECAM-04-2018-017.

MacDonald, J.A. (2012). A Framework for Collaborative BIM Education across the AEC Disciplines, 37th Annual Conference of the AUBEA, University of NSW, Australia. Retrieved May 11, 2013, from [http://codebim.com/wp-content/uploads/2013/06/2012\\_Macdonald\\_AUBEA.pdf](http://codebim.com/wp-content/uploads/2013/06/2012_Macdonald_AUBEA.pdf)



## BIM UTILIZATION IN FACILITIES MANAGEMENT PRACTICE: A STATUS STUDY IN SOUTH AFRICA

Faith Dowelani<sup>1</sup> and Aghaegbuna O. U. Ozumba<sup>2</sup>

<sup>1</sup>*School of Construction Economics, University of Pretoria, South Africa,*

<sup>2</sup>*School of Construction Economics and Management, University of the Witwatersrand, South Africa*

Facilities Management is the most extended phase in the life cycle of a facility. To effectively manage facilities' electronic information is needed. An integrated information management system such as Building Information Modelling (BIM) can be utilised to support data at any given phase of a building life cycle. Literature review shows that there are benefits to using BIM in Facilities Management. However, there is insufficient research regarding the use of BIM in Facilities Management in South Africa. The purpose of this research was to investigate the extent to which BIM is utilised in the South African Facilities Management sector. The findings reveal that majority of Facilities Management practitioners are not utilising BIM, due to factors relating to cost and weak support organisations. Those who use BIM believe that the model does not have enough information to carry out all Facilities Management activities.

Keywords: BIM, buildings, facilities, ICT, management

### INTRODUCTION

Facilities Management (FM) encompasses multiple roles for the purpose of ensuring the functionality of the built environment through the integration of people, places, processes and technology (International Facility Management Association, (IFMA), 2015). FM's primary focus and function are to manage changes that occur in the relationship between organisations, their employees, and their facilities (Chotipanich, 2004). According to Nutt (2004), the relationship involves an extensive range of activities including but not limited to the;

1. Physical use of built space, use of technology, provision of services, ensuring maintenance as well as modification and adaptation where necessary;
2. Human and business component of facility purpose, its use and function, provision of security, ensuring safety, comfort, and environmental health; and

---

<sup>1</sup> fdowelani@gmail.com

<sup>2</sup> Obinna.ozumba@wits.ac.za



3. Financial issues of property investment, asset value, and the costs and benefits of occupancy.

One significant challenge that can be experienced in FM is information collection, storage and sharing (Eastman, Teicholz, Sacks and Liston, 2011). The main reason that hampers information management is that most of the FM information is documented in paper formats, which are not easy to locate and maintain (Mendez, 2006).

The use of information in FM is no longer limited to the maintenance records for routine, reactive or compliance purposes, but rather it involves operational and strategic elements where data and information are captured, processed, shared, applied and reported (Achoru, 2015). With technological advancements in the digital age, FM teams are encouraged to transfer and store building information in digital formats that are readily available (Teicholz, 2013). Therefore, effective FM requires an integrated information management system that provides practitioners with adequate information to control maintenance functions to support day-to-day operations and decision making (Graddy, 2010; Chen and Wang, 2009).

Information management systems such as Computerised Maintenance Management System (CMMS), Computer-Aided Facility Management (CAFM), Integrated Workplace Management Systems (IWMS), Enterprise Asset Management (EAM) and Building Information Modelling (BIM) can be used for storing and sharing FM information. BIM is a model for defining a facility's physical and functional characteristics in a digital form (Gardezi, Shafiq, Nurudin, Farhan and Umar, 2014).

BIM emerged as a technological information management process and product that tackles interoperability and information integration issues in early 2000 (Motamedi, 2013). BIM involves spatial relationships, light analysis, geographic information, and building components' quantities and properties (Eastman et al., 2011). Current BIM software is therefore used by individuals, businesses and government agencies in infrastructure planning, design, construction and FM (Azhar, 2011). The use of BIM in FM can have numerous benefits, including but not limited to faster and more effective information sharing and cost control (Arayici, Onyenobi and Egbu, 2012). With the advancement of BIM, there has been evidence of BIM adoption and its use in developed countries such as the United Kingdom (UK) and the United States of America (USA). The use of BIM in the UK (Succar, Sher and Williams, 2012; Sabol, 2008; Arayici et al., 2012). Unfortunately, the use of BIM is mainly focused on design, preconstruction and construction phases (Hilal, Maqsood, and Abdekhodae, 2019). Hence, the use of BIM in FM has been noted as generally lagging behind relative to other AEC sub-sectors (Sabol, 2008). Despite the potential and significant benefits, BIM in FM is still relatively in its infancy (Korpela and Miettinen 2013; Lui and Issa, 2013); the situation has also been highlighted in the context of South Africa (Kotze, 2013).

## **BACKGROUND TO THE STUDY**

FM, as a growing profession in the built environment, has evolved over time. FM is the process needed to support and enhance an organisation's core business by

ensuring that its buildings, systems and services provide a quality, cost-effective environment for people and processes (Chotipanich, 2004). FM coordinates all efforts related to planning, designing and managing buildings and their systems, equipment and furniture (Becker, 1990).

It is an integrated approach to operating, maintaining, improving, and adapting the buildings and infrastructure of an organisation to create an environment that strongly supports that organisation's primary objectives (Rondeau et al., 2012). In addition, FM can be seen as the application of the total quality techniques used for improving quality, adding value and reducing the risk associated with building occupation and support services delivery (Alexandra, 2001), with the primary function of the process being resource management at strategic and operational levels of support (Liu and Su, 2013). The South African Facilities Management Association (SAFMA) ascertains that FM enables sustainable enterprise performance through the whole life management of productive workplaces and effective business support services (Atkin and Brooks, 2015).

FM's scope is broad; FM is no longer limited to the maintenance records for routine, reactive or compliance purposes. Instead, it involves operational and strategic elements where data and information are captured, processed, shared, applied and reported (Achoru, 2015). Effective information management is the cornerstone of successful FM, which enables forward planning to support the core business (Atkin and Brooks, 2015). In its electronic form, information can be easily stored, collected, analysed, and shared (Teicholz, 2013).

BIM offers an integrated digital platform to store, manage and share information obtained from the planning to FM stage (BIFM, 2012). BIM has functions and tools that can be used to support FM functions for both new and existing buildings (Volk et al., 2014). FM enabled BIM model contains FM data which can be used to support FM tasks involving space analysis, retrofitting and preventative maintenance (Pishdad-Bozorgi, Gao, Eastman and Self, 2018). Arguably the importance of information management cannot be overemphasised.

The Sydney Opera House case study (Sabol, 2008) successfully demonstrated the potential benefits of BIM in FM. Other case studies include a renovation project at the University of Chicago, where BIM was linked to existing CMMS and CAFM systems during the administration building's renovation (Teicholz, 2013). According to Temmink and Ritter (2020), BIM is the first half of a Digital Twin that considers people and their potential actions within the building. The study of, Becerik-Gerber et al. (2012) interviewed FM practitioners on the role of BIM and found that using BIM decreases the chances of errors and increases efficiency. Korpela and Miettinen (2013) also found that in FM, BIM can be used for space management, planning and scheduling maintenance tasks, operations data such as energy use, allocating and managing assets, and facilitating maintenance.

Furthermore, BIM can be used as a tool to track the types and quantities of materials, equipment and spaces of a facility. When integrated with the CAFM system, BIM provides notable benefits such as utility cost reductions, comfort management, space optimisation, improved inventory management and energy simulation and conservation (Love et al., 2014.) Furthermore, when BIM is utilised in FM, there is an improvement in the quality of life (QOL) in the workplace that

encompasses multiple disciplines to ensure higher functionality of the built environment (Aziz, Nawawi and Ariff, 2016). Research on the utilisation of BIM in FM focuses mainly on its implementation in refurbishment and maintenance, energy efficiency, knowledge management and existing building (Matarneh et al., 2019).

Even though the AECO industry has recognised the potential benefits of BIM for FM (Lui et al., 2015), there is an increase in BIM uptake in the UK due to the Government mandated BIM Level 2 for public-funded projects (Carbonari, Stravoravdis and Gausden, 2018). There is a perception that the industry has been slow to participate in the developments of BIM and that facility managers are not precisely sure about how BIM can be utilised effectively. Several researchers have cited the critical factor of successful BIM implementation as seamless information management exchange between various BIM-FM systems and data exchange standards and regulations (Chan, 2014; Mehran, 2016; Matarneh et al., 2019;), Government support and pressure ( Willis and Regmi, 2016; McPartland, 2017; Succar et al., 2013) and BIM awareness and education ( Azhar, 2011; Almutiri, 2016). In South Africa, there is evidence that BIM usage is growing amongst architects relative to contractors and other construction professionals (Froise and Shakantu, 2014). Most architects implement 3D BIM compliant software such as ArchiCAD and Revit (Booyen et al., 2013), while a small percentage work exclusively in a BIM environment (Froise and Shakantu, 2014). Architects use BIM for drawing, visualisation, conceptual design functions scheduling, programming, costing and collaboration with other consultants (Froise and Shakantu, 2014). Even though some architecture companies are using BIM tools, Kipprotich (2014) asserts that most of them do not realise the extent to which BIM should be used and what BIM can do.

In construction, BIM compliant software has been implemented increasingly for cost management, construction management and project management (Kekana et al., 2015). While, in quantity surveying, a BIM compliant system, Dimension X, is commonly used for cost estimating and quantity take-off (Booyens et al., 2013). BIM has been used in South Africa on projects such as Kusile Power Station, Medupi Power Station and the 2010 FIFA World Cup stadiums (Booyens, Bouwman and Burger, 2013; Kipprotich, 2014).

Although there is awareness of BIM in South Africa, the rate of BIM adoption in the country is very low (Kekana et al., 2015). According to Froise and Shakantu (2014), less than 10% of South African contractors are familiar with BIM. Some of the factors identified in the literature that contributes to the slow uptake of BIM in South Africa are:

- Lack of communication between various stakeholders, whereby architects are not designing with quantity surveyors, contractors and facility managers in mind (Booyens et al., 2013). This non-systemic approach results in further fragmentation of the sector as it causes hindrances in design collaboration and design data losses, leading to wasteful iterative design processes (Wortmann, Root and Venkatachalam, 2016).

- Lack of mandated or best practice BIM standards, specifications or protocols in South Africa (Wortmann et al., 2016). The lack of BIM regulation affects the rate of BIM adoption in South Africa (Froise and Shakantu, 2014).

There is, therefore, a scarcity of literature exploring the actual use of BIM in Facilities Management within South Africa. This research aims to determine the levels and extent of BIM utilisation in FM practice, focusing on FM practitioners in South Africa. The pertinent question was derived as; what is the nature of BIM utilisation in FM practice among FM practitioners in South Africa? A fieldwork approach was adopted to address the research question through a research design detailed in the following section.

## **RESEARCH DESIGN**

To answer the research question, two data-collection tools were developed for data collection. The first was a qualitative interview guide, and the second, a mixed open- and close-ended self-administered questionnaire. Using both methods in the same study is a viable option to obtain complementary findings and strengthen the findings (Thurmond, 2001). The two methods are different in approach; Interviews are more exploratory, while a questionnaire is more confirmatory (Harris and Brown, 2010)

Identification of items for the research and preparation of the interview guide as well as the questionnaire was a crucial step for the success of the research. A significant amount of work has already been done on items of BIM functions and the use of BIM. In addition, there is a well-documented and peer-reviewed set of those available items in the literature review. Using the latter, the two data-collection tools were developed for the study.

### **Data collection**

A semi-structured interview method was used. The interview guide had two sections—the first section aimed at collecting demographic and background information. The second section constituted of five questions gathering information about operations at facility management companies. The interview took 30 minutes. Interviews were crucial in collecting information used to develop the questionnaire.

The questionnaire was administered to the respondents through an online platform, Qualtrics©, which is used for data collection and management. Thereafter a link was generated through Qualtrics© and sent to 123 participants via email. However, the link was only sent to members of SAFMA, whose core business is FM.

### **Data analysis**

The data were analysed using grounded theory and descriptive statics. The data was collected in 2016. The research population included facilities management professionals registered with the SAFMA. The population from which a sample was drawn for this research comprised 950 FM practitioners registered with SAFMA, amongst which 360 are based in Gauteng Province, which is the study's geographical scope. However, only 30 surveys were found useful for analysis.

## Sampling

This research used purposive sampling. The chosen method allowed the researcher to select a sample of people who would give the most accurate information. A small number of practitioners who provided in-depth information about the topic were selected from a sample of FM practitioners registered with SAFMA to participate in the interview and questionnaire survey

## RESULTS

### Interview Data

#### *Industry Experts Interview*

Four industry experts from FM organisations were identified and interviewed in Gauteng Province. Three were male and one female. The age range was between 35 and 55 years of age. In terms of education, two had bachelor's degrees whilst the other two had Masters degrees. See Table 1.

**Table 1: Position, age, gender and qualification of the interviewee**

Interviewee	Position	Age	Gender	Qualification
A	FM consultant	Over 55	Male	Degree
B	FM manager	35-46	Female	Masters
C	FM director	Over 55	Male	Degree
D	FM director	35-46	Male	Masters

#### *FM functions*

Both respondents C and D work within organisations that focus on all areas of FM. These organisations manage over 100 facilities. Respondent B is only involved in facility planning and real estate, while Respondent A, functions in building operation and management, strategic planning, outsourcing and insourcing.

**Table 2: FM functions which the respondents are involved**

Organisational functions	Interviewee
Facilities planning	C, D
Building operations and maintenance	A, C, D
Real estate and building construction	B, C, D
General office services	C, D
Outsourcing and insourcing	A, C, D
Green building	A, C
Strategic planning	A, C, D
Other. Specify	

#### *Information management in FM*

Sections of the questions asked concerning this theme are presented below in Table 3. The results indicate that the respondents are digital-ready, as all four of them receive, store and manage information digitally.

**Table 3: Information management**

Interviewee	Receive	Store	Manage	Share
A	Digital and paper	Digital	Digital	Digital
B	Digital	Digital	Digital	Digital
C	Paper and Digital	Digital	Digital	Digital
D	Paper and Digital	Paper and Digital	Paper and Digital	Paper and Digital

**BIM utilisation**

The interviews revealed that only respondent, A had used BIM previously as an employee, but he was not using BIM currently. Respondents B, C and D have never used BIM even though they are aware of it. They all suggested that the directive to use BIM must come from the designers and contractors, and they will follow suit.

In addition, Respondent A believed that BIM would only be fully considered in FM if the Government imposes specific rules, such as in the UK, where a level 2 of BIM is required for public projects. Respondent C further suggested that their organisation is willing to explore BIM for FM. Furthermore, Respondent C proposed a public sector driven BIM adoption for FM in South Africa.

**Survey data**

***FM information management***

For the question, in which format do you usually require FM information? Respondents could choose any format, and the question also allowed for multiple selections. Some of the respondents chose more than one response. Therefore, the total number of responses were more than those of the participants. Table 4. shows that 36% of FM information is received in paper formats, 44% in a digital copy on CD/DVD, 17% in BIM, 22% through BIM integrated into CMMS, and 19% through other means. Those who specified other means mentioned emails with a PDF attachment.

**Table 4: FM information formats**

Information format	Percentage of responses
Physical paper copy	36.11%
Digital copy on CD/ DVD	44.44%
BIM	16.67%
BIM integrated into CMMS	22.22%
Other. Specify PDF, MS Excel, Cherwell	19.44%

***FM information formats***

The respondents were asked how they store, share and manage FM information. The respondents indicated that most information is stored and managed digitally on a server via MS Excel, PDF and Cherwell. However, significant amounts of paper are involved, such as service records, invoices, and equipment manuals stored physically on-site and off-site. In addition, FM information is shared via emails, SharePoint and Dropbox.

***BIM utilisation***

To ascertain the level of BIM utilisation in FM, the respondents were asked if they use BIM or have used BIM for FM. The data from questionnaires shows that a small amount (20%) of FM practitioners use or have used BIM for FM, while 80% responded no, as shown in Table 5.

**Table 5: Use of BIM model for Facility Management**

	Answer	Percentage
1	Yes	20.0%
2	No	80.0%
	Total	100%

Further analysis of the respondents that use BIM for FM indicated that of the 20% who have used BIM or are currently using BIM, 50% consider themselves as intermediate users, 25% as beginners and 25% are experts. These results suggest that most BIM users are at ease with utilising BIM to support their FM functions. See figure 1 below

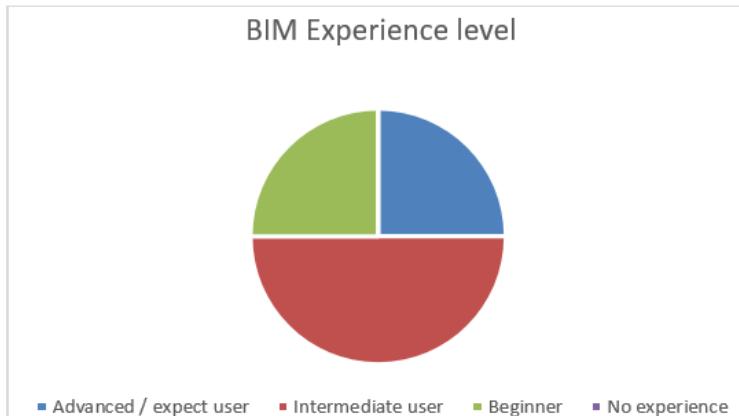

Figure1: BIM experience level

Figure 2 illustrate that 37.5% of BIM users use BIM in facility planning and building operations and maintenance, while 25% use BIM general office services. Findings also indicate that 75% of BIM users believe the system carries part of the information they require for FM and that manual inputs are still required.

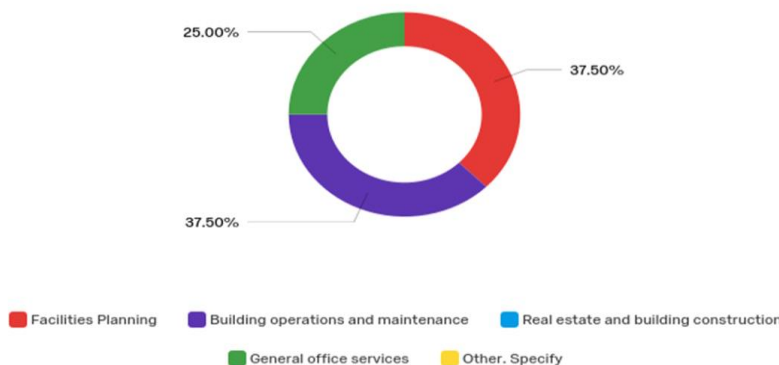

Figure 2: Area of FM where BIM is utilised

## FINDING AND DISCUSSIONS

The data collected contains very diverse opinions and information from experienced FM practitioners. In analysing the data, the answers to all questions were linked to three thematic areas, namely FM functions, Information Management, Utilisation of BIM in South Africa.

According to the literature, FM functions include facility planning, Real Estate, building operations and maintenance management and general premises management. Figure 1 illustrates that approximately 38% of FM organisations within South Africa focus on building operation and maintenance management. These findings are similar to Kiprotich (2004), who suggested that FM

organisations' primary focus is building operations and maintenance. FM information is better stored and received in a digital format (Teicholz, 2013), but most buildings store their documentation in paper formats (Sabol, 2008). To further ascertain the level of digitalisation, the survey confirms that 44% of the respondents receive FM information in digital formats, while 36% receive information in paper format Table 4. These results suggest that the South African FM industry is transforming and is moving towards total digitalisation.

Moreno, Olbina, and Issa (2019) found that regardless of the participants' discipline, they indicated less frequent use of BIM in FM. Similarly, the data from this study show that a small amount (20%) of FM practitioners use or have used BIM for FM, as shown in Table 5. This finding corroborates with Becerik-Gerber et al. (2012)'s statement, which states that globally, some organisations push for BIM use in AEC while industry-wide adoption of BIM in FM has not been embraced. And the findings of, Kekana et al. (2015) indicate that only 38% of AEC practitioners are currently using BIM in South Africa, which means that the use of BIM in FM in South Africa is lagging behind its use AEC. This reveals that there is a gap in the use of BIM in FM. And Further analysis shows that organisations are not propelling adoption and awareness of BIM to support their FM functions.

Lastly, the findings show that BIM users use BIM to store, share and manage information and that some of the required information is still received and stored in paper format. This finding is supported by Bjork (2010) and Becerik-Geber et al. (2012); they believe that FM information is still received, stored and shared in paper format. This hinders the use of BIM in FM as Practitioners are of the option that information received in paper format takes too much effort and time to input FM information into BIM. This can be justified by considering that in developed countries, BIM is mandated, whereas BIM is not mandated, and there are no regulatory initiatives towards BIM implementation in developing countries.

## **CONCLUSION**

This research aimed to determine the levels and extent of BIM utilisation in FM practice among FM practitioners in South Africa. As such, it is essential to note that FM practitioners in South Africa are still receiving, sharing and storing FM information in paper format. Those who use BIM find that BIM for FM does not have enough information for FM. Some of the information they require for FM must be captured manually into the system. It is costly and time-consuming to capture/input all the necessary data into a BIM model. These findings suggest that there is a low level of BIM utilisation in FM.

Whereas complexity and skill requirements heavily as challenges to BIM adoption by FM practitioners, findings from this current study also highlight a lack of appreciation of the extent to which BIM could improve their work. For FM practitioners to start using BIM, there is a need for the industry to educate the practitioners on the benefits of BIM in FM, for the Government to develop BIM adoption strategies and mandatory initiatives and for FM organisations to invest in BIM and collaborate with other stakeholders continuously. It is evident there is a scarcity of information regarding the utilisation of BIM-FM in practice in South Africa. The lack of evidence creates a knowledge gap in terms of best practice and



case study examples to prove the level and extent of BIM utilisation in FM in the context of South Africa. As such, the level of BIM utilisation in FM is not known.

## REFERENCES

- Alexander, K. (2001). *Facilities Management Theory and Practice*. New York: Taylor and Francis Group.
- Almutiri, Y. R. (2016). Empirical investigation into development of a curricular framework to embed building information modelling with undergraduate architectural programmes within Saudi Arabia (Doctoral dissertation, University of Salford).
- Achoru, A. M. (2015) Effective Facilities Management through Management Information System: A Case Study of Industrial Training Fund ITF Building Abuja. *Research Journal of Technology Management*. vol. 21
- Arayici, Y., Onyenobi, T., & Egbu, C. (2012). "Building Information Modeling BIM for Facilities Management FM: The Mediacity Case Study Approach". *International Journal Of 3-D Information Modeling*, vol.1 (1), pp.55–73.
- Atkin, B., & Brooks, A. (2015). *Total Facility Management*. 4th Ed. United Kingdom: John Wiley and Sons.
- Azhar, S. (2011). "Building Information Modeling BIM: Trends, Benefits, Risks, and Challenges for the AEC Industry," *Journal of Leadership and Management in Engineering*, vol. 11, pp. 241–252.
- Aziz, N., Nawawi, A., & Ariff, N. (2016), Building information modelling (BIM) in facilities management: opportunities to be considered by facility managers, *Procedia – Social and Behavioral Sciences*, vol. 234, pp. 353-362.
- Becerik-Gerber, B., Asce, A.M., Jazizadeh, F., Li, N., & Gulben, C. (2012). 'Application Areas and Data Requirements for BIM Enabled Facilities Management'. *Journal of Construction Engineering and Management*, vol. 138 (3), pp. 431–442.
- Becker, F. (1990). *The Total Workplace*, Van Nostrand Reinhold, New York, NY.
- BIFM (2012). BIM and FM: Bridging the gap for success, [Online], Available:<http://www.bifm.org.uk/bifm/filegrab/3bim-fm-report-bridgingthegapforsuccess.pdf>. Accessed: 03/09/ 2016.
- Booyens, D., Bouwman, H., & Burger, M. (2013). 'The Status of Building Image Modelling in the South African Construction 'Industry'. *The 2nd Year of Advanced Research in Scientific Areas*.
- Carbonari, G., Stravoravdis, S. & Gausden, C. (2018), "Improving FM task efficiency through BIM: a proposal for BIM implementation", *Journal of Corporate Real Estate*, vol. 20, no. 1, pp. 4-15.
- Chan, C. T. W. (2014). Barriers of implementing BIM in construction industry from the designers' perspective: A Hong Kong experience. *Journal of System and Management Sciences*, 4(2), 24-40.
- Chen, H. M., & Wang, Y. H. (2009). A 3-Dimensional Visualized Approach for Maintenance and Management of Facilities. *Proceedings of ISARC09*, pp 468–475.
- Chotipanich, S. (2004): Positioning facility management. *Facilities* 22(13), 364-372.
- Eastman, C., Teicholz, P., Sacks, R., & Liston, K. (2011): *The BIM Handbook: A Guide to Building Information Modeling For Owners, Managers, Designers, Engineers and Contractors* 2nd Ed. New Jersey: John Wiley and Sons.

- Froise, T., Shakantu, W. (2014). Diffusion of innovations: an assessment of building information modelling uptake trends in SOUTH AFRICA, *Journal of Construction Project Management and Innovation*.
- Graddy, M. (2010). Using Decision Analysis to Select Facility Maintenance Management Information Systems. Retrieved From <http://www.dtic.mil/dtic/tr/fulltext/u2/A521271.pdf>.
- Gardezi, S. S. S., Shafiq, N., Nurudinn, M. F., Farhan, S. A., & Umar, U. A. (2014). Challenges for implementation of building information modeling (BIM) in Malaysian construction industry. In *Applied Mechanics and Materials*, vol. 567, pp. 559–564. Trans Tech Publications Ltd.
- Harris, L. R., & Brown, G. T. L. (2010). "Mixing Interview and Questionnaires Method: Practical Problems in Aligning 'Data'", *Journal of Practical Assessment, Research and Evaluation*, vol. 15 (1).
- Hilal, M., Maqsood, T., & Abdekhodae, A. (2019), "A scientometric analysis of BIM studies in facilities management", *International Journal of Building Pathology and Adaptation*, vol. 37(2), pp. 122-139.
- International Facility Management Association IFMA. Online: <http://www.ifma.org>. Accessed 03/03/2016.
- Kekana, T. G., Aigbavboa, CO & Thwala, W. D. (2014). Building Information Modelling BIM: Barriers in Adoption and Implementation Strategies in the South Africa Construction Industry. *International Conference of Emerging Trends in Computer Image Processing*.
- Kiprotich, C. J. K. (2014). An Investigation on Building Information Modelling In Project Management: Challenges, Strategies and Prospects in the Gauteng Construction Industry, South Africa. Retrieved from [http://mobile.wiredspace.wits.ac.za/bitstream/handle/10539/15492/Charles%20Kiprotich\\_FINAL%20REPORT\\_February%202014.pdf?sequence=2](http://mobile.wiredspace.wits.ac.za/bitstream/handle/10539/15492/Charles%20Kiprotich_FINAL%20REPORT_February%202014.pdf?sequence=2)
- Korpela, J., & Miettinen, R. (2013). BIM in Facility Management and Maintenance: The Case Study of Kaisa Library of Helsinki University. Paper Presented In 29th Annual ARCOM Conference, pp 47–56.
- Kotze, C. (2013). BIM Technology Uptake in SA. *Engineering News*.
- Lin, Y. C. & Su, Y. C. (2013). 'Developing Mobile and BIM Based Integrated Visual Facility Maintenance Management System'. *The Scientific World Journal*.
- Liu, L.Y., Stumpf, A. L., & Kim, S. S. (2014). Capturing As-Built Project for Facility Management', pp 614–621.
- Liu, R., & Issa, R. (2015). Survey: " Common "Knowledge in BIM for Facility Maintenance", " *the Journal of Performance of Constructed Facilities*, vol. 303.
- Liu, R., & Issa, R. R. A. (2013). 'BIM for Facility Management: Design for Maintainability with BIM Tools'. *Proceedings of the 30th ISARC, Montréal, Canada*.
- Love, P. E. D., Matthews, J., Simpson, I., Hill, A., & Olatunji, O. A. (2014), "A benefits realization management building information modeling framework for asset owners", *Automation in Construction*, Vol. 37 No. 1, pp. 1-10.
- Matarneh, S. T., Danso-Amoako, M., Al-Bizri, S., Gaterell, M., & Matarneh, R. (2019), "Building information modeling for facilities management: A literature review and future research directions", *Journal of Building Engineering*, vol 24, <https://doi.org/10.1016/j.jobbe.2019.100755>.

- McPartland, R., (2017). 10 rules for a successful BIM implementation. [Online] Available at: <https://www.thenbs.com/knowledge/10-rules-for-a-successful-bim-implementation>
- Mehran, D., (2016). Exploring the Adoption of BIM in the UAE Construction Industry for AEC Firms. Dubai, UAE, *Procedia Engineering*, vol145, pp.1110-1118.
- Mendez, R. O. (2006). The Building Information Model in Facilities Management. Retrieved from <https://www.wpi.edu/pubs/ETD/Available/Etd-050406-153423/Unrestricted/Rmendezetd.Pdf>
- Moreno, C., Olbina, S., & Issa, R. R. (2019). "BIM use by architecture, engineering, and construction (AEC) industry in educational facility projects," *Advances in Civil Engineering*, vol. 2019, pp 19
- Motamedi, A. (2013). Improving Facilities Lifecycle Management Using Rfid Localization and Bim-Based Visual Analytics. Retrieved from [http://spectrum.library.concordia.ca/977834/1/Motamedi\\_PhD\\_S2014.Pdf](http://spectrum.library.concordia.ca/977834/1/Motamedi_PhD_S2014.Pdf).
- Nutt, B. (2004), infrastructure and facilities: forgoing alignments between supply and demand. Conference proceeding of future in property and facility management, University College, London
- Pishdad-Bozorgi, P., Gao, X., Eastman, C., & Self, A. P. (2018). Planning and developing facility management-enabled building information model (FM-enabled BIM). *Automation in Construction*. vol 87, pp. 22-38
- Rondeau, E. P., Brown, R. K., & Lapides, P. D. (2012). *Facility Management*. 2nd Ed. United Kingdom: John Wiley and Sons.
- Sabol, L. (2008). Building Information Modeling and Facility Management. Design and Construction strategies, LLC, Washington, DC. Retrieved From [http://www.dcstrategies.net/files/2\\_Sabol\\_Cost\\_Estimating.Pdf](http://www.dcstrategies.net/files/2_Sabol_Cost_Estimating.Pdf).
- Succar, B., Sher, W., & Williams, A. (2012). Measuring BIM performance: Five metrics. *Architectural Engineering and Design Management*, vol.8(2), pp.120-142.
- Succar, B., Sher, W., & Williams, A., (2013). An integrated approach to BIM competency assessment, acquisition and application. *Automation in construction*, 35, pp.174-189.
- Teicholz, P. (2013). *BIM for Facility Management*. Canada: John Wiley and Sons.
- Temmink, C., & Ritter, T. (2020). How Can Corporate Facilities Management Support an Organization's Digital Transformation? Retrieved from <https://it.ifma.org/wp-content/uploads/2020/08/Digital-Transformation-Article.pdf>
- Thurmond, V. A. (2001). Triangulation, *Journal of Nursing Scholarship*, vol. 333, pp 253-258.
- Willis, C. J., & Regmi, T. (2016). Exploring the Future Use of BIM in Construction Project. Toronto, Ontario, Associated Schools of Construction.
- Wortmann, A. E., Root, D. S., & Venkatachalam, S. (2016). Building Information Modelling BIM Standards and specifications around the world and its applicability to the South African AEC sector: A critical review. Proceedings of the 1st International BIM Academic Forum BAF Conference, Glasgow. 13-15 September 2015. Glasgow Caledonian University, Scotland



---

## CHALLENGES TO SUSTAINABLE AFFORDABLE HOUSING USING FRUGAL INNOVATION

David Mbabel Dok-Yen<sup>1</sup>, Duah Daniel Yaw Addai<sup>2</sup> and Michael Nii Addy<sup>3</sup>

<sup>1,3</sup> *Department of Construction Technology and Management, Kwame Nkrumah University of Science and Technology, Kumasi, Ghana*

<sup>2</sup> *Department of Architecture, Kwame Nkrumah University of Science and Technology, Kumasi, Ghana*

Across the globe, and especially in the developed world, housing remains one of the crucial challenges of growth due to the immense difference between housing supply and demand. Broadly speaking, the housing crisis is primarily a matter of demand for housing, outstripping supply and/or the price of housing above the average worker's income. The global COVID 19 pandemic has shown how important it is to reduce the global housing crisis by ensuring sustainable, affordable, and healthy housing for all. However, in terms, of financial and limited natural resources, one idea currently gaining traction is frugal innovation. The aim of this research is to establish the challenges to sustainable affordable housing using frugal innovation. Frugal innovation is simple, a low-cost innovation (LCI) developed to serve customers at the bottom of the pyramid (BOP) of the unserved mass market. A comprehensive literature review was conducted using a deductive approach. The structured survey questionnaire was used as an instrument for collecting data, using a non-probability purposive sampling technique, and the data was analysed using descriptive statistics. The seven (7) most significant challenges to sustainable affordable housing using frugal innovation in Ghana are; difficulty in significantly lowering costs while retaining functions, perceived low benefit or profit return on investment, lack of research and design, lack of demand, ineffective local partners, difficulty establishing key functional elements, and low confidentiality. This research will build an immense contribution to improving the access for all adequate, safe and affordable housing and basic services and upgrade the slums of the sustainable development goal target of the 2030. Future research should focus on how to use frugal innovation to effectively establish the core functional elements of a sustainable, affordable housing system, and how to apply frugal innovation to other construction sectors, especially in developing countries.

Keywords: affordable housing, frugal innovation, sustainability

## INTRODUCTION

Frugal innovation (FI) simply refers to efforts to produce products or services that offer customers significant cost savings over existing alternatives in order to meet

---

<sup>1</sup> dydavid@tatu.edu.gh

<sup>2</sup> duahdani@gmail.com

<sup>3</sup> mnaddy.cabe@knust.edu.gh

the needs of resource-constrained consumers (Zeschky et al., 2011). FI focuses on re-designing products, services, and business models by lowering complexity throughout the product's complete lifecycle costs, while maintaining high value and affordable solutions for the unserved market of BOP customers in developing nations (Agarwal and Brem, 2012; Bhatti, 2012; Rao, 2013; Zeschky et al., 2011).

Frugal innovation (FI) is rapidly becoming a benchmark for assessing alternative, sustainability (Basu and Sweeny, 2013). The 17 Sustainable Development Goals (SDGs) outline unsolved global issues including poverty alleviation and social exclusion (Arnold, 2018). To solve global sustainability, frugal innovation can be considered a key competency (Basu and Sweeny, 2013). The phenomenon of financial and natural resource limitations calls for imaginative ways to counteract these conditions in times of limited resources. In this regard, one idea currently gaining traction as a relatively new innovation is frugal innovation (Imhof and Mahrr, 2017). The aim of this study is to establish the challenges to sustainable affordable housing (SAH) in Ghana using frugal innovation (FI).

The global COVID 19 pandemic has shown how important it is to reduce the global housing crisis by ensuring sustainable, affordable, and healthy housing for all, according to the Sustainable Development Goals (UN-Habitat, 2020). Sustainable affordable housing (SAH) through frugal innovation will be the way forward from the new COVID-19 protocols of social distance and isolation. Housing shortages in Ghana have crossed 2 million units, this does not however, account for the projected housing needs for isolation and social distancing for CODVID-19 houses, implying that the government will have to build more than 200,000 houses every year for the next decade to close the gap (Minister for Works and Housing, 2019).

The world is gradually becoming more urbanised. More than 50% population in the world lived in cities since 2007, and this number is projected to rise to 60% by 2030 (United Nations, 2019). Cities and metropolitan areas are the driving forces of economic growth, accounting for more than 60% of global GDP. On the other hand, they account for more than 70% of global greenhouse gas emissions and about 60% of resource consumption (United Nations, 2019). Rapid urbanization causes air pollution and unplanned urban sprawl in many slum dwellers, as well as inadequate and overwhelmed infrastructure and services (including waste disposal, water and sanitation systems, roads and transport). COVID-19 will have the most negative effects in poor and densely populated urban areas, especially for the one billion people living in informal settlements and slums around the world, where overcrowding already makes it difficult to take recommended measures, including social distancing and self-isolation measures (UN-Habitat, 2020 ).

However, most developed countries have failed in the past to pursue a cost-effective innovation strategy, and due to conventional approaches to product and service innovation, the world is experiencing resource shortages, environmental damage, and a number of other negative consequences (Sammut-Bonnici et al., 2015). Several well-known scholars, including Chan et al., (2018), Agyekum et al., (2019), Oke et al., (2019), Ayakwa et al.,(2017), and so on. Despite research into various challenges to sustainable building development, no study has attempted to apply the concept of frugal innovation to the development of sustainable affordable housing, resulting in a significant gap in the literature on the application

of frugal innovation concept to sustainable affordable housing and construction in general. Therefore, to close this gap, it will be imperative to establish the challenges to sustainable affordable housing using frugal innovation, hence the need for this research.

## **FRUGAL INNOVATION**

Frugal innovation is clearly defined as Low-cost innovation (LCIs) produced or manufactured to serve consumers at the bottom of the pyramid (BOP) of the unserved mass market is specifically characterised as frugal innovation. The term "unserved" refers to a category of people that cannot afford a particular product, service, or housing for the cost of the product or service, which may be due to its complexity or sophistication, technical requirements, structural elements, or complex design nature, making it costly (Kahle et al., 2013; Lim and Fujimoto, 2019). Furthermore, frugal innovation aims to optimise use of materials and financial resources across the entire value chain (development, production, delivery, use, and disposal) by using minimal raw materials, reusing existing parts, lightweight structures, and cutting-edge technologies to achieve low costs and a low cost of ownership while simultaneously satisfying customer demands. The production of low-cost mass-market products that are affordable to all social strata, including the less affluent segments, is the economic significance of frugal innovation (Sammut-Bonnici et al., 2015). It's characterised by a scarcity of resources to build low-cost, climate-friendly technologies. Comparatively to conventional product development methods, these resource-constrained product development techniques can result in products that are more sustainable, resulting in lower energy consumption and greater supply chain efficiencies (Sharma and Iyer, 2012; Khan, 2016). Frugal innovation is also consistent with (ecological and social) sustainability because it is more affordable and accessible than conventional technology because it uses fewer resources (raw materials, manufacturing resources, energy, heat, water, waste, financial resources) than traditional technology (Albert, 2019). Frugal innovation is critical to achieving social sustainability; it promotes the SDGs and contributes to the larger goal of sustainable growth (Khan, 2016).

Although they are other concepts similar and sometimes interchangeable with frugal innovation, including grassroots, disruptive, jugaad, Gandhian innovation and reverse innovations, resource-constrained innovation, good-enough innovation etc. (Brem and Wolfram, 2014; Zeschky et al., 2014a; Soni and Krishnan, 2014; Prabhu and Jain, 2015; Hossain et al., 2016). FI is perceived as a better concept that encompasses various different types of innovation under one umbrella (Adari and Ganesh, 2015).

### **Challenges to SAH using Frugal Innovation (FI)**

Frugal innovation is often not concerned with environmental sustainability (Sharma and Iyer, 2012), and it appears that environmental sustainability is more of a byproduct than a primary reason for frugal initiatives (Wohlfart et al., 2016). Weyrauch and Herstatt (2016) point out that frugal innovation need not mean sustainability, and that sustainability is not frugal innovation's primary objective. In their debate, Levanen et al. (2015) point out that conceptually equating frugality and sustainability is problematic. Usage of inefficient raw material processing

practises to address resource-constrained problems poses a danger to the ecological and social climate. Furthermore, in the pursuit of extreme affordability, there is unsustainable low-cost manufacturing and processing, which can result in substantial waste generation. The emphasis on limited resources and affordability can divert attention away from long-term consequences, including technology mingling with non-sustainable components. The rebound effect may influence how frugal innovation is used or consumed. If frugal innovation is produced more affordable, more customers will buy it and use it, resulting in increased demand and probably more environmental damage (increasing material use, energy use, and waste generation). When it comes to end-of-life concerns, cost-cutting innovation will cause environmental problems due to improper disposal. Another danger is that a less expensive, lower-cost innovation could cannibalise a company's existing high-end service, resulting in a drop in sales. Furthermore, if a low-cost innovation falls short of the previous company's performance, the company's image can be damaged (Albert, 2019).

Lack of public awareness, expense, and insufficient knowledge are some major barriers to sustainable affordable housing using frugal innovation (Oke et al., 2019). In addition, one of the major challenges to the effective adoption of sustainable construction methods was identified as insufficient financial incentives, including high taxes and low profit margins. This contrasts with the results of Djakoto et al. (2014), who found that a lack of demand was the most significant obstacle to achieving long-term affordable housing through frugal innovation. (Ayakwa et al., 2017). Previous research has shown that both emerging and developed countries face difficulties achieving Sustainable affordable housing through frugal innovation. The five critical barriers to sustainable housing in the United States, according to Ahn et al. (2013), are high cost efficiency, long payback times, a proclivity to continue existing practises, restricted subcontractors' expertise and skills, and higher prices of sustainable goods and materials. In a similar report, the most critical barriers to sustainable affordable housing using frugal innovation in the US were identified as resistance to reform, higher costs of sustainability, insufficient information and understanding, insufficient expertise, and insufficient government incentives (Chan et al., 2016). High costs of equipment and materials, insufficient interest and communication firms, insufficient research, insufficient interest among clients and market demand, a lengthy pre-construction phase, and uncertainty with sustainable materials and equipment were also major challenges in Singapore (Hwang et al., 2012; Hwang et al., 2013). Moreover, higher prices, insufficient government incentives, insufficient funding schemes including bank loans, the unavailability of suppliers, and insufficient local institutes and facilities for R&D were identified as the five major challenges to sustainable affordable housing in technology and innovation in Ghana (Chan et al., 2018). Likewise, the eight main barriers to the implementation of green certification of buildings in Ghana are lack of information on existing sustainable housing, lack of incentives, conservatism of Ghanaians, lack of active government participation, insufficient human resources, lack of awareness of gains, costs and financing, and lack of legal support (Agyekum et al., 2019).

In addition, Love et al.,(2011) described one of the key impediments to sustainable development as a lack of government incentives (green building). According to Obeng-Odoom and Amedzro (2011), the high inflation rate in building materials

and other development factors is a major obstacle to the economic sustainability of affordable housing. High interest rates and "tight credit conditions" are also obstacles (Boamah, 2010). According to Trudeau (2018) and Nguyen et al.,(2013), one of the main obstacles to its implementation is "group resistance to affordable housing programs." Similarly, Sturzaker (2011) said that there is strong opposition in the United Kingdom to social housing. As well, income inequality between households is an obstacle to social cohesion. For example, a "poor culture of mortgages" (Sidawi and Meeran, 2011) and "high mortgage defaults" (Boamah, 2010) do not encourage financial institutions to participate in housing supply. Furthermore, Ruparathna and Hewage's,(2015) report, obstacles include the lack of consideration of sustainability standards in the evaluation of bids, the lack of traditional procurement processes, the lack of awareness of local conditions and the lack of clear legislative provisions covering sustainable procurement in Canada. According to Shafii et al.,(2006), barriers to sustainable buildings in Malaysia include a lack of awareness of sustainable buildings, a lack of training and training, higher costs of sustainable building options, procurement problems, regulatory barriers, a lack of professional skills / designers, incentives for local material production and a lack of case studies / examples. The biggest obstacle to the delivery of sustainable buildings is a lack of awareness, information and understanding (Jusoh, 2015). According to a study conducted in Malaysia, one of the biggest obstacles to the construction of green buildings in the country is the lack of public knowledge. People's knowledge of the definition of green housing should be improved first, then business knowledge, and finally industry knowledge (Lop et al., 2012; Lim et al., 2018). Although the most significant barriers to GBT adoption in developing countries, including Ghana, differ from those in developed countries such as the United States, Canada, and Australia, higher GBT costs remain a major challenge among all, according to a comparative study (Chan et al., 2018).

## **METHODOLOGY**

For this research, a comprehensive literature review was conducted using a deductive approach to develop current literature on the challenges of sustainable affordable housing using frugal innovation as a reference (Syed-Jamaludin et al.,2018). The structured survey questionnaire was used as an instrument for collecting one-time cross-sectional quantitative primary data for the analysis. The data was collected using a non-probability purposive sampling technique (Owusu-Manu et al.,2018;Oke et al., 2019;Debrah et al., 2020). The questionnaires were designed with Google Survey Form and distributed to only stakeholders within the housing and construction industry with the knowledge, experience, accessible and willing to provide the needed information for the study. They were contacted for the data collection using online (via email and Whatsapp) to allow for easy and quick responses. However, measures were put in place to prevent multiple responses via email verification by ensuring that each response was verified once with only one email of respondents. Although this approach had its limitation, especially when a respondent with multiple emails decides to use it to respond multiple times it was very uncommon. 103 questionnaires were returned answered out of 200 distributed to stakeholders in Ghana's building and housing market, primarily architects, quantity surveyors, consultants, engineers, academicians, both public and private sectors, contractors, and others. The data from the Google form



survey was extracted to Excel and then exported to SPSS to obtain the data compliant with any type of research format provided by SPSS. The data was analysed using descriptive statistics to extract percentages and frequencies; mean and standard deviation were used to analyse the difficulties. This was based, on previous research, of a similar nature (Otalı and Ujene,2020).

## **DATA ANALYSIS**

### **Data analysis on background of stakeholders**

Respondents' background information was provided in frequencies and percentages. First, the data on gender, age and professional background are grouped in Table 1.0, as they all fall into a single set of responses from which the respondents were asked to choose, while the professional background as well as the type of company / organisation / institution is represented in Figure 1.0 and Figure 2.0. All but 103 of the 200 questionnaires distributed were returned with answers. Most of the respondents (94.2%) were males, with only 5.8% being females. The most common age group for respondents was 20-29 years, which accounted for 50.5% of all responses, followed by 30-39 years, which accounted for 35.9%, and 40-49 years, which accounted for 12.6 percent of all responses. The results indicate 34 respondents out of 103 total respondents have the highest educational qualification, accounting for 33% of the total responses. Post-graduates, master's, and doctoral degrees were the highest credentials, with 19 respondents accounting for 18.4 percent of all responses. Bachelor's degrees are the lowest qualification (BSc.). However, the highest qualification was Higher National Diploma (HND), with 48 respondents representing 46.6 percent, while Technician (CTC I/II/III/Advance) and other qualifications each had one respondent. The findings also showed respondents' years of working experience were mainly 1-5 years, with 54 responses representing 52.4% of the total, 6-10 years, with 25 respondents representing 24.3 percent, and 11-15 years, with 23.3 percent of the total responses.

Respondents' professional backgrounds, as shown in Figure 1.0, were primarily stakeholders in the housing and construction sector, including architects, quantity surveyors, engineers (all categories), lecturers, teachers, and others in the housing industry. Most of the respondents were Building Technology, construction management, and housing related students, both those who had completed tertiary education and those who were in their final year at the universities in Ghana, accounting for 44.6 percent of the total responses. Quantity surveyors came in second with 24 respondents accounting for 23.8 percent of the total responses, and engineers (all ages) came in third. The types of business, organisation, or institution, of respondents were conversely considered significantly for the study in figure 2.0. The results from the study revealed that most of the respondents were from academic/research institutions, with 36 respondents accounting 35.6 percent of the general responses, followed by contracting firms 24 respondents, accounting for 23.8 percent of the general responses, and other forms of construction and housing related sectors with 18, accounting for 17.8 percent of the total respondents. Also, consulting firms with 16 respondents representing 15.8 percent and so on as can be seen in figure 2.0.

**Table 1: Background of respondents**

Gender	Frequency	Percent
Male	97	94.2
Female	6	5.8
Total	103	100.0
<b>Age</b>		
20-29 years	52	50.5
30-39 years	37	35.9
40-49 years	13	12.6
50-59 years	1	1.0
Total	103	100.0
<b>Highest Educational Qualification</b>		
Post-Graduate/Master/PhD	34	33.0
Bachelor degree (Bsc)	19	18.4
Higher National Diploma (HND)	48	46.6
Technician (CTC I/II/III)/Advance	1	1.0
Others	1	1.0
Total	103	100.0
<b>Years of working experience</b>		
1-5	54	52.4
6-10	25	24.3
11-15 and above	24	23.3
Total	103	100.0

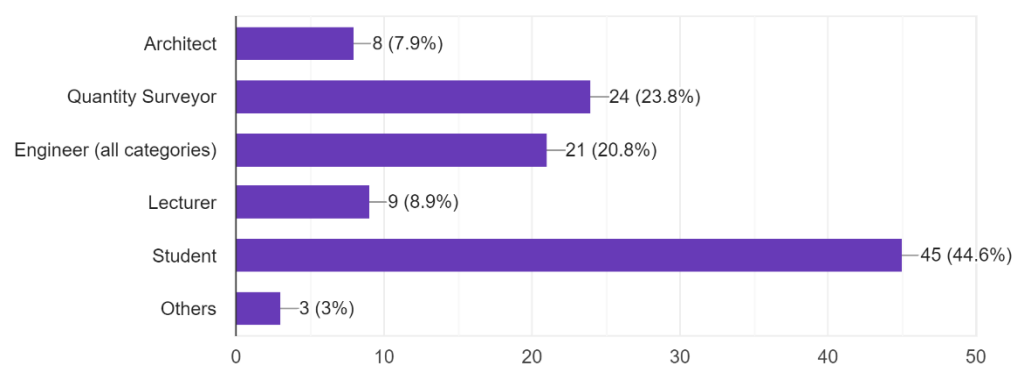

**Figure 1.0 Professional Background**

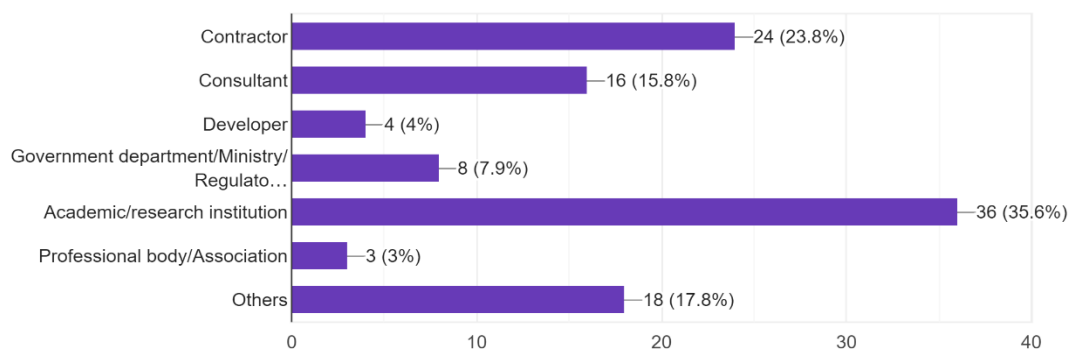

**Figure 2.0 Type of company/organisation/Institution**

### Data analysis on challenges to SAH using FI

The data on the challenges to sustainable affordable housing using frugal innovation concept was extracted into mean and standard deviation score values for all the variables. In table 2.0, respondents were asked to rank on whether, variables were; 1=Very Significant, 2=Significant, 3=Not sure, 4=Insignificant, and 5=Very insignificant, in accordance with previous research.

**Table 2.0 Challenges to SAH using FI**

Descriptive Statistics						
	N	Minimum	Maximum	Mean	Std. Deviation	Rank
Difficulty reducing cost substantially while maintaining functions	103	1.00	5.00	2.3398	1.03425	1 <sup>st</sup>
Perceived slow/low profit return on investment	103	1.00	5.00	2.2913	.93548	2 <sup>nd</sup>
Lack of research and design	103	1.00	5.00	2.2913	1.00617	3 <sup>rd</sup>
Lack of demand	103	1.00	5.00	2.2718	1.04969	4 <sup>th</sup>
Unreliable local partners	103	1.00	5.00	2.2621	.94932	5 <sup>th</sup>
Difficulty in establishing core functional elements	103	1.00	5.00	2.2621	1.03811	6 <sup>th</sup>
Low confidentiality	103	1.00	5.00	2.2427	.98485	7 <sup>th</sup>
Perceived higher cost	102	1.00	5.00	2.2255	1.00402	8 <sup>th</sup>
Lack of standard measurements/scaling	103	1.00	5.00	2.2233	.99933	9 <sup>th</sup>
High tax system	103	1.00	5.00	2.2136	.90370	10 <sup>th</sup>
Risk associated with Investing/implementation of new practices	103	1.00	5.00	2.1845	.82542	11 <sup>th</sup>
Concern on brand image/high quality	103	1.00	5.00	2.1650	.88669	12 <sup>th</sup>
Lack of clear benefits of concept	103	1.00	5.00	2.1650	.97112	13 <sup>th</sup>
Lack of funding_	103	1.00	5.00	2.1359	.99063	14 <sup>th</sup>
Lack of reliable information on cost savings associated with frugal	103	1.00	5.00	2.1165	1.03186	15 <sup>th</sup>
Lack of existing houses or examples for people to appreciate concept	103	1.00	5.00	2.1068	1.03765	16 <sup>th</sup>
Lack of skill/expertise/professional know-how	103	1.00	5.00	2.1068	1.14543	17 <sup>th</sup>
Lack of government commitment	103	1.00	5.00	2.0971	.96522	18 <sup>th</sup>
Lack of methods to support the adoption	103	1.00	5.00	2.0971	.97533	19 <sup>th</sup>
Resistance to changes in the current practices	103	1.00	5.00	2.0971	.97533	20 <sup>th</sup>
Lack of training opportunities systems	103	1.00	5.00	2.0971	1.04332	21 <sup>st</sup>
Lack of legislation enforcement and monitoring	103	1.00	5.00	2.0971	1.04332	22 <sup>nd</sup>
Lack of measurement tool to showcase benefits	103	1.00	5.00	2.0971	1.02436	23 <sup>rd</sup>
Compliance to conventional standards building codes/regulations	103	1.00	5.00	2.0874	1.07655	24 <sup>th</sup>
Lack of cooperation among stakeholders	103	1.00	5.00	2.0777	.91490	25 <sup>th</sup>
Perceived increase in cost and time	103	1.00	5.00	2.0583	.97845	26 <sup>th</sup>
Resistance/unwillingness to change from current practices	103	1.00	5.00	2.0583	.87251	27 <sup>th</sup>
Lack of publicity strategy approach to promote concept	103	1.00	5.00	2.0583	.96837	28 <sup>th</sup>
Lack of creativity to simplify and find alternatives approach	103	1.00	5.00	2.0291	.94409	29 <sup>th</sup>
Lack of public awareness of the benefits	103	1.00	5.00	2.0291	.90159	30 <sup>th</sup>
Risk associated with investing in new concepts	103	1.00	5.00	2.0291	.84548	31 <sup>st</sup>
Lack of adaptation to local innovation	103	1.00	5.00	2.0000	1.07558	32 <sup>nd</sup>
Insufficient resource availability scarcity of inputs	103	1.00	5.00	1.9806	.94952	33 <sup>rd</sup>
Lack of national policy direction	103	1.00	5.00	1.9806	.99981	34 <sup>th</sup>
Lack of local documentation/standards	103	1.00	5.00	1.9612	.89577	35 <sup>th</sup>
Institutional weakness	103	1.00	4.00	1.9515	.98398	36 <sup>th</sup>
Lack of awareness education	103	1.00	5.00	1.9515	.96384	37 <sup>th</sup>
Lack of government incentives and support_	103	1.00	5.00	1.9515	.87871	38 <sup>th</sup>
Price sensitive clients	103	1.00	4.00	1.9223	.73684	39 <sup>th</sup>
Contract conditions/specification	103	1.00	4.00	1.8252	.79739	40 <sup>th</sup>
Lack of government commitments/support incentives for innovation	103	1.00	5.00	1.8058	1.03903	41 <sup>st</sup>

When comparing variables using mean score, the variable with the highest mean score value is ranked higher than the variable with the lowest mean score value (Chan et al., 2018). Where two or more variables have the same mean value, however, the one with the lowest standard deviation (SD) rank is ranked higher (Owusu-Manu et al.,2019; Kissi et al.2020 and Debrah et al., 2020).

Table 2.0 shows that the biggest challenge to sustainable, affordable housing with frugal innovation was seen as the difficulty of substantially reducing costs while maintaining functions, with the highest mean score of 2.34 among all variables. Second to it was perceived slow/low profit return on investment, which has the same mean score of 2.29 with lack of research and design since it had a lower SD= .94. Lack of research and design was rated as the third most significant challenge to sustainable affordable housing using frugal innovation, whereas lack of demand was ranked as the fourth most significant challenge with a mean of 2.27. Unreliable local partners were ranked as the fifth most important challenge for sustainable affordable housing using frugal innovations, with an average of 2.262 and SD of 1.049; difficulty in identifying core functional elements was ranked sixth, with an average of 2.262 and SD of 1.038; and low confidentiality was ranked seventh, with an average of 2.2427, followed by perceived higher cost, lack of standard measurements/scaling, and high tax respectively as challenges.

**One-sample T-test**

Once again, this is a one-sample situation. The data was subjected to a test analysis to determine whether the mean score data produced on the challenges of sustainable housing in terms of affordable housing through frugal innovation was statistically relevant. The one-sample T-test is a statistical method for determining the relative significance of variables by examining the mean difference between the sample and the known value of the population mean (Ross and Willson, 2017; Owusu-Manu et al., 2018; Kassi et al., 2020; Debrah et al., 2020). If variables had a p-value (significance of the test) of P 0.05 at 95% confidence interval of the difference, they were considered important, while variables with a p-value >0.05 were considered insignificant. If the null hypothesis is valid, the p-value is simply the probability that random variables will take on values farther from the mean (Debrah et al., 2020). Table 3.0 shows that all 42 variables have a sig. 000 value less than the p-value (p0.05). Thus, the study found that all the challenges of sustainable affordable housing using frugal innovation presented for the study were statistically significant.

**Table 3.0**

One-Sample Test						
	Test Value = 0				95% Confidence Interval of the Difference	
	t	df	-value	p	Mean Difference	Upper
Lack of awareness/education	20.548	102	.000	1.95146	1.7631	2.1398
Risk associated with Investing/implementation of new practices	26.859	102	.000	2.18447	2.0231	2.3458
High tax system	24.859	102	.000	2.21359	2.0370	2.3902
Lack of national policy direction_	20.105	102	.000	1.98058	1.7852	2.1760
Lack of local documentation/standards	22.220	102	.000	1.96117	1.7861	2.1362
Institutional/weakness	20.128	102	.000	1.95146	1.7591	2.1438
Insufficient resource availability scarcity of inputs	21.169	102	.000	1.98058	1.7950	2.1662
Price sensitive clients_	26.477	102	.000	1.92233	1.7783	2.0663

Concern on brand image high quality	24.781	102	.000	2.16505	1.9918	2.3383
Lack of adaptation to local innovation	18.872	102	.000	2.00000	1.7898	2.2102
Perceived slow low profit return on investment	24.858	102	.000	2.29126	2.1084	2.4741
Unreliable local partners_	24.184	102	.000	2.26214	2.0766	2.4477
Low confidentiality	23.111	102	.000	2.24272	2.0502	2.4352
Lack of clear benefits of concept_	22.626	102	.000	2.16505	1.9753	2.3548
Lack of existing houses or examples for people to appreciate concept	20.606	102	.000	2.10680	1.9040	2.3096
Lack of government commitments/support incentives for innovation	17.639	102	.000	1.80583	1.6028	2.0089
Lack of skill expertise/professional know-how	18.667	102	.000	2.10680	1.8829	2.3307
Lack of publicity strategy/approach to promote concept	21.571	102	.000	2.05825	1.8690	2.2475
Lack of demand_	21.965	102	.000	2.27184	2.0667	2.4770
Lack of legislation enforcement and monitoring	20.399	102	.000	2.09709	1.8932	2.3010
Lack of government incentives and support	22.539	102	.000	1.95146	1.7797	2.1232
Lack of public awareness of the benefits_	22.841	102	.000	2.02913	1.8529	2.2053
Resistance/unwillingness to change from current practices	23.941	102	.000	2.05825	1.8877	2.2288
Lack of training opportunities systems	20.399	102	.000	2.09709	1.8932	2.3010
Perceived increase in cost and time	21.349	102	.000	2.05825	1.8670	2.2495
Lack of measurement tool to showcase benefits_	20.777	102	.000	2.09709	1.8969	2.2973
Lack of cooperation among stakeholders_	23.047	102	.000	2.07767	1.8989	2.2565
Risk associated with investing in new concepts_	24.357	102	.000	2.02913	1.8639	2.1944
Lack of local documentation/standards	22.220	102	.000	1.96117	1.7861	2.1362
Perceived higher cost_	22.386	101	.000	2.22549	2.0283	2.4227
Lack of research and design_	23.111	102	.000	2.29126	2.0946	2.4879
Resistance to changes in the current practices_	21.821	102	.000	2.09709	1.9065	2.2877
Lack of reliable information on cost savings associated with frugal innovation	20.817	102	.000	2.11650	1.9148	2.3182
Lack of methods to support the adoption	21.821	102	.000	2.09709	1.9065	2.2877
Lack of government commitment_	22.050	102	.000	2.09709	1.9084	2.2857
Lack of funding_	21.882	102	.000	2.13592	1.9423	2.3295
Difficulty reducing cost substantially while maintaining function	22.960	102	.000	2.33981	2.1377	2.5419
Difficulty in establishing core functional elements	22.115	102	.000	2.26214	2.0592	2.4650
Lack of standard measurements scaling	22.579	102	.000	2.22330	2.0280	2.4186
Lack of creativity to simplify and find alternatives approach	21.813	102	.000	2.02913	1.8446	2.2136
Compliance to conventional standards building regulations	19.678	102	.000	2.08738	1.8770	2.2978
Contract conditions/pacification	23.231	102	.000	1.82524	1.6694	1.9811

### Reliability test

Furthermore, using Cronbach's Alpha coefficient ( $\alpha$ ), a reliability test was performed on the data to determine the accuracy of the study's findings when repeated independently on the same test sample at a different period. It determines the reliability of the questionnaire by measuring the internal accuracy of a list of items in the questionnaire (Chan et al., 2018). If the Cronbach Alpha Test yields a co-efficient of 0.700 or higher, the scale is considered accurate (Muijs, 2010; Hair et al. 2010). The table 4.0 below shows that the study has a Cronbach's alpha of 0.960, indicating it is accurate for further research.

**Table 4.0: Reliability statistics**

Cronbach's Alpha	Cronbach's Alpha Based on Standardized Items	N of Items
.960	.960	42

## DISCUSSION

### Background of stakeholders

The study's findings showed almost all stakeholders in the housing sector are male-dominated, as shown by the fact that 94.2% of the respondents were males. Most of the respondents were young people aged 20 to 29 years (50.5%) and 30-39 years (35.9%), implying that about 86.4 percent of the stakeholders in the housing sector for this study were young people. Higher National Diploma (HND) was the most common educational qualification among respondents, accounting for 46.6 percent, followed by post-graduates, masters and Ph.D. at 33 percent, and Bachelor degree (BSc.) at 18.4 percent. Quantity surveyors, building and construction related engineers within government departments, academicians, and architects in Ghana were the main housing stakeholders in this research.

### Challenges to SAH using FI

For this research, the major challenges to sustainable affordable housing using frugal innovation were identified as follows: difficulty in reducing costs significantly while maintaining functions (mean=2.34), Slow/low benefit return on investment (Mean=2.29, SD=0.94), lack of research and design (mean = 2.29, SD = 1.006), lack of demand (mean = 2.27), unreliable local partners (mean=2.262,SD=.949), difficulty defining the key functional elements (mean=2.262,SD=1.038), and low confidentiality (mean= 2.2427).

The complexity or ability to implement something new or innovating differently while simultaneously minimising cost or resources is the real challenge for frugal innovation, according to Pisoni's,(2018) report. Weyrauch and Herstatt,(2016), whereas, offer a major solution to this problem by focusing on only the main functional elements of the product, which results in a lower price or slightly lower prices of product or service as opposed to traditional goods and services. For this report, the lack of research and design was revealed as the third most significant obstacle to sustainable affordable housing using frugal innovation. This is in line with Chan et al., (2018), Hwang and Tan, (2012), and Hwang and Ng, (2013) studies, which identified a shortage of local institutes and facilities for R&D as one of the major challenges to affordable housing sustainability. Low profit returns on investment are a major obstacle, owing to the fact that most housing developers are profit-driven. This proof backs up due to the high initial cost associated with sustainable housing growth, Syed-Jamaludin et al., (2018) believe developers are more interested in profit and careless about sustainability issues. Again, one of the major challenges to sustainable affordable housing using frugal innovation is a lack of client demand. This is significant because demand is often perceived to be the driver of production, from the basic economics principle that the lower the price, the higher the demand, so profit can be maximised by increasing production to meet demand, thereby making lack of demand, a significant challenge. This is consistent with previous research, like Djakoto et al.,(2014) report, which found that

lack of demand is one of the most significant barriers to sustainable housing. It also supports Hwang and Tan's (2012), Hwang and Ng's (2013) findings that lack of consumer demand, and interest among clients is a major barrier to sustainable affordable housing using frugal innovation. However, the most significant obstacle to sustainable building development, according to the literature reviewed for this report, is high costs and a lack of knowledge (Hwang and Tan, 2012; Hwang and Ng, 2013; Ahn et al., 2013; Chan et al., 2016; Chan et al., 2018, Agyekum et al., 2019). Although this study contradicts this, it nevertheless describes them as barriers to sustainability of affordable housing through frugal innovation, but not as the biggest challenges to sustainable affordable housing using frugal innovation.

## **CONCLUSION**

The aim of this study was to establish the challenges to sustainable affordable housing through frugal innovation. Quantitative data was obtained from stakeholders in Ghana's building and housing sectors using survey questionnaires. The seven (7) most significant challenges to sustainable affordable housing using frugal innovation in Ghana are: the difficulty in significantly reducing costs while retaining functions, perceived low benefit or profit return on investment, lack of research and design, lack of demand, ineffective local partners, difficulty in establishing key functional elements, and low confidentiality. This research finding presents a significant contribution to the theoretical and practical knowledge on the application of frugal innovation concept to the development and construction of affordable housing in general; as well as help stakeholders especially the government, academic institutions and housing solutions practitioners to improve their policy direction in housing development in Ghana. This study offers guidelines to UN-SDGs and UN-Habitat policymakers on how to use frugal innovation in the drive to make cities inclusive, secure, resilient, and prosperous by 2030, as part of their sustainable cities agenda. The research will make a significant contribution to the theoretical knowledge gap in sustainable affordable housing, which is currently lacking in literature, and would lead to knowledge in applying the frugal innovation concept to sustainable affordable housing development, commonly used in the manufacturing and service sectors. Housing professionals and developers in their housing developments can learn from this finding to plan to how to overcome the challenges to sustainable affordable housing using frugal innovation concept. This study will also serve as a blueprint for potential studies in the field of affordable housing that is both sustainable and frugal. Future research should focus on how to use frugal innovation to effectively establish the core functional elements of a sustainable, affordable housing system, and how to apply frugal innovation to other construction sectors, especially in developing countries. Finally, future research should focus on developing a framework for sustainable affordable housing using frugal innovation.

## **REFERENCES**

Adari, P., & Ganesh, L. (2015), 'Frugal Innovation in Smaller Firms in the West'. Master's Thesis. Halmstad, Sweden: Halmstad University.

- Agyekum, K., Adinyira, E., Baiden, B., & Ampratwum, G. (2019), 'Barriers to the adoption of green certification of buildings: A thematic analysis of verbatim comments from built environment professionals', *Journal of Engineering, Design and Technology*, 17(5), pp. 1035–1055.
- Agarwal, N., & Brem, A. (2012), 'Frugal and reverse innovation-Literature overview and case study insights from a German MNC in India and China'. In *Engineering, Technology and Innovation (ICE), 2012 18th International ICE Conference* (pp. 1-11). IEEE.
- Ahn, Y. H., Pearce, A. R., Wang, Y., & Wang, G. (2013), 'Drivers and barriers of sustainable design and construction: the perception of green building experience'. *Int. J. Sustain. Build. Technol. Urban Dev.* 4 (1)
- Albert, M. (2019). 'Sustainable frugal innovation - The connection between frugal innovation and sustainability'. *J. Clean. Prod.* 237, 117747.
- Ametepey, O., Aigbavboa, C. & Ansah, K. (2015) 'Barriers to Successful Implementation of Sustainable Construction in the Ghanaian Construction Industry', *Procedia Manufacturing*, 3, pp. 1682–1689.
- Arnold, M.G. (2018). Sustainability value creation in frugal contexts to foster Sustainable Development Goals. *Bus. Strategy Dev.* 1, 265
- Ayarkwa, J., Acheampong, A., Wiafe, F. & Boateng, B. E. (2017), 'Factors affecting the implementation of sustainable construction in Ghana: the architect's perspective', *ICIDA 2017-6th International Conference on Infrastructure Development in Africa*, pp. 12-14, [Online], available at: [https://www.researchgate.net/publication/317277282\\_Factors\\_Affecting\\_the\\_Implementation\\_of\\_Sustainable\\_Construction\\_in\\_Ghana\\_the\\_Architect's\\_Perspective](https://www.researchgate.net/publication/317277282_Factors_Affecting_the_Implementation_of_Sustainable_Construction_in_Ghana_the_Architect's_Perspective) (accessed 24th January, 2021).
- Brem, A., & Wolfram, P. (2014), 'Research and development from the bottom up-introduction of terminologies for new product development in emerging markets'. *Journal of Innovation and Entrepreneurship*, 3 (1), 1-22.
- Bhatti, Y. A. (2012), 'What is frugal, what is innovation? Towards a theory of frugal innovation'.
- Basu, R. R., Banerjee, P. M., & Sweeny, E. G. (2013), 'Frugal innovation: core competencies to address global sustainability. *J. Manag. Global Sustain.* 2.
- Boamah, N. A., (2010). Housing affordability in Ghana: a focus on Kumasi and Tamale'. *Ethiop. J. Environ. Stud. Manag.* 3 (3).
- Chan, A. P. C., Darko, A., Olanipekun, A. O., & Ameyaw, E. E., (2018) 'Critical barriers to green building technologies adoption in developing countries: The case of Ghana', *Journal of Cleaner Production*, 172, pp. 1067–1079. doi: 10.1016/j.jclepro.2017.10.235.
- Darko, A. & Chan, A. P. C. (2016), "Critical analysis of green building research trend in construction journals", *Habitat International*, Vol. 57, pp. 53-63.
- Debrah, C., Owusu-Manu, D., & Kissi, E., (2020) 'Barriers to green cities development in developing countries: evidence from Ghana', *Smart and Sustainable Built Environment*, ahead-of-print(ahead-of-print).
- Djokoto, S. D., Dadzie, J., & Ohemeng-Ababio, E. (2014). Barriers to sustainable construction in the Ghanaian construction industry: consultants 'perspectives'. *Journal of Sustainable Development*, 7 (1), 134.
- Hossain, M., Simula, H., & Halme, M. (2016), 'Can frugal go global? Diffusion patterns of frugal innovations'. *Technology in Society* 46, 132–139.



- Hwang, B. G., & Ng, W. J. (2013), Project management knowledge and skills for green construction: overcoming challenges. *Int. J. Proj. Manag.* 31 (2)
- Hwang, B. G., & Tan, J. S. (2012) Green building project management: obstacles and solutions for sustainable development. *Sustain. Dev.* 20 (5).
- Imhof, M. & Mahr, J. (2017) 'Applying Frugal Innovation to Serve the Bottom of the Pyramid in Germany', *OpenAIRE*. Available at: [https://explore.openaire.eu/search/publication?articleId=od\\_264::e924c9bef80a6d982b9a9f7121913b68](https://explore.openaire.eu/search/publication?articleId=od_264::e924c9bef80a6d982b9a9f7121913b68). Accessed 4<sup>th</sup> January, 2021.
- Jusoh, Z. M. (2015). Preferences on Green Home Attributes among Malaysian Households. *Journal of Research in Business, Economics and Management*, 4(2), 323-333.
- Khan, R. (2016) 'How Frugal Innovation Promotes Social Sustainability', *Sustainability*, 8, p. 1034.
- Kissi, E., Samuel, A. S., Agyemang, D. Y., Daniel, O. & Caleb, D. (2020), "Identification of factors influencing the pricing of sustainable construction materials in developing countries: views of Ghanaian quantity surveyors", *International Journal of Construction Management*, pp. 1-10.
- Lev€anen, J., Hossain, M., Lyytinen, T., Hyv€arinen, A., Numminen, S., & Halme, M., (2015), Implications of frugal innovations on sustainable development: evaluating water and energy innovations. *Sustainability* 8 (4),
- Lim, C. K., Tan, K. L., & Hambira, N. (2018), 'An investigation on level of public awareness of green homes in Malaysia through web-based illustrations', in. *Proceedings of the 3<sup>rd</sup> International Conference on Applied Science and Technology (Icast'18), Penang, Malaysia*.
- Lim, C., & Fujimoto, T. (2019), 'Frugal innovation and design changes expanding the cost-performance frontier : A Schumpeterian approach'. *Res. Policy* 48, 1016–1029.
- Love, P. E., Niedzweicki, M., Bullen, P. A., & Edwards, D. J. ( 2011), 'Achieving the green building council of Australia's world leadership rating in an office building in Perth'. *J. Constr. Eng. Manag.* 138 (5).
- Lop, N. S., Abidin, Z. Z., Md Zain, N., Mohd Kamar, I., Mat Salleh, N., & Mohamad Hamdan, N. (2012), 'Awareness Improvement Amongst End Users Towards The Economic Sustainability In Green Homes: A Research Proposal'. *1st International Conference on Innovation and Technology for Sustainable Built Environment 2012*, 561-565.
- Muijs, D. (2010), *Doing Quantitative Research in Education with SPSS*, Sage Publications, Thousand Oaks, CA, ISBN 144624234X978144624234.
- Minister for Works and Housing (2019), 'Ghana is addressing the housing deficit by supporting the construction of affordable homes and easing access to mortgages'. <https://oxfordbusinessgroup.com/analysis/narrow-gap-addressing-housing-deficit-increasing-stock-affordable-homes-and-easing-access-mortgages>. Accessed 9<sup>th</sup> April, 2021.
- Nguyen, M. T., Basolo, V., & Tiwari, A. (2013), 'Opposition to affordable housing in the USA: debate framing and the responses of local actors'. *Hous. Theory Soc.* 3(2).
- Obeng-Odoom, F., & Amedzro, L. (2011), 'Inadequate housing in Ghana'. *Urbani Izziv* 22 (1).
- Oke, A., Aghimien, D., Aigbavboa, C. & Musenga, C. (2019), 'Drivers of sustainable construction practices in the Zambian construction industry'. In: *Energy Procedia, 10th International Conference on Applied Energy (ICAE2018)*, 22-25 August 2018, Hong Kong, China.

- Otali, M. & Ujene, A. (2020), 'Assessment of the level of awareness of sustainability practices among construction firms in Niger delta, Nigeria', 11(1), p. 22.
- Owusu-Manu, D. G., Debrah, C., Antwi-Afari, P., & Edwards, D. J. (2019), 'Barriers of project bond initiatives in infrastructure financing in Ghana', *Construction Industry Development Board Postgraduate Research Conference*, Springer, Cham, Vols 12-21
- Owusu-Manu, D. G., Edwards, D. J., Kukah, A. S., Parn, E. A., El-Gohary, H. & Hosseini, M. R. (2018), 'An empirical examination of moral hazards and adverse selection on PPP projects', *Journal of Engineering, Design and Technology*, Vol. 16 No. 6, pp.
- Pisoni, A., Michelini, L., & Martignoni, G. (2018), 'Frugal approach to innovation : State of the art and future perspectives', *Journal of Cleaner Production*. Elsevier Ltd, 171, pp. 107–126.
- Prabhu, J., & Jain, S. (2015), 'Innovation and entrepreneurship in India: Understanding jugaad'. *Asia Pacific Journal of Management*, v. 32, n. 4, p. 843-868.
- Ruparathna, R., & Hewage, K., (2015), 'Sustainable procurement in the Canadian construction industry: Current practices, drivers and opportunities'. *J. Clean. Prod.* 109, 305–314.
- Sammut-bonnici, T., Mcgee, J. & Management, S. (2015), 'Frugal Innovation', [:https://www.researchgate.net/publication/257303451](https://www.researchgate.net/publication/257303451). Accessed April, 2021.
- Sharma, A., & Iyer, G. R. (2012), 'Resource-constrained product development: implications for green marketing and green supply chains'. *Ind. Mark. Manag.* 41.
- Shafii, F., Ali, Z. A., & Othman, M. Z. (2006), 'Achieving sustainable construction in the developing countries of Southeast Asia'. *In Proceedings of the 6th Asia-Pacific Structural Engineering and Construction Conference*, Kuala Lumpur, Malaysia, 5–6 September 2006.
- Sidawi, B., & Meeran, S. (2011), 'A framework for providing lifelong finance to the owners of affordable dwellings in the Kingdom of Saudi Arabia'. *Cities*. 28 (2).
- Soni, P., & Krishnan, T. R. (2014), 'Frugal innovation: aligning theory, practice, and public policy'. *Journal of Indian Business Research*, 6(1), 29-47.
- Sturzaker, J. (2011), 'Can community empowerment reduce opposition to housing?' *Evidence from rural England. Plan. Pract. Res.* 26 (5).
- Trudeau, D. (2018), 'Integrating social equity in sustainable development practice: institutional commitments and patient capital'. *Sustain. Cities Soc.* 41.
- UN-Habitat (2020), UN-Habitat COVID-19 Response Plan, pp. 1–16.
- United Nations (2019) 'The sustainable development goals report 2019', *United Nations publication issued by the Department of Economic and Social Affairs*, p. 64. Available at: <https://undocs.org/E/2019/68>. Accessed 20th April, 2021.
- Syed Jamaludin, S. Z. H., Mahayuddin, S. A. & Hamid, S. H. A. (2018), 'Challenges of Integrating Affordable and Sustainable Housing in Malaysia', *IOP Conference Series: Earth and Environmental Science*, 140, p. 012001.
- Rao, B. C. (2013), 'How disruptive is frugal?' *Technol. Soc.*, 35, 65–73.
- Ross, A., & Willson, V. L. (2017), 'One-sample t-test', *Basic and Advanced Statistical Tests*, Brill Sense, pp. 9-12, available at: <https://brill.com/view/book/edcoll/9789463510868/BP000003>

- Ruparathna, R., & Hewage, K. (2015), 'Sustainable procurement in the Canadian construction industry: Current practices, drivers and opportunities'. *J. Clean. Prod.* 109, 305–314.
- Weyrauch, T., & Herstatt, C. (2016), 'What is frugal innovation? Three defining criteria'. *J. Frugal Innov.* 2 (1)
- Wohlfart, L., Bünger, M., Lang-Koetz, C., & Wagner, F. (2016), 'Corporate and grassroots frugal innovation: a comparison of top-down and bottom-up strategies'. *Technol. Innov. Manag. Rev.* 6 (4).
- Zeschky, M. B., Widenmayer B., & Gassmann, O. (2011), 'Frugal Innovations in Emerging Markets'. *Research Technology Management* 54(4): 38-45.
- Zeschky, M. B., Winterhalter, S., & Gassmann, O. (2014), 'From Cost to Frugal and Reverse Innovation: Mapping the Field and Implications for Global Competitiveness'. *Research Technology Management* 57(4): 20-27.



## COMPARATIVE ANALYSIS OF SOUNDNESS AND SETTING TIME OF PORTLAND CEMENT OF THREE COMPANIES IN NIGERIA

Angulu Haruna<sup>1</sup>, Abba Musa<sup>2</sup>, Samaila Hamza<sup>3</sup>, Galadima Muhammad<sup>4</sup> and Odesanmi Atinuke<sup>5</sup>

<sup>1,2,3,4,5</sup>*Department of Vocational and Technology Education, Faculty of Technology Education, Abubakar Tafawa Balewa University, Bauchi, Nigeria*

This study was designed to compare and analyze the soundness and setting time of Ashaka, BUA and Dangote portland cements in Nigeria. For quite some times in Nigeria, the news of collapsed building has been forming the headlines of Nigerian newspapers, some of the reasons for the collapsed buildings were attributed to the quality of materials used, the workmanship, as well as the integrity of professionals that handled the projects. To carry out this study, Explanatory Sequential Mixed Method Research Design was employed for this study. In the first instance, laboratory experiments were carried out using Le chatelier apparatus to carry out the soundness test, while Vicat apparatus was used to analyze the setting time of the cement samples from the three companies. The samples from the three companies were used and the results were presented in tables and charts format. The results of the study revealed that: Dangote is sounder with its expansion of 0.1mm, followed by Ashaka Portland cement with the expansion of 0.2mm and lastly BUA Portland cement with the expansion of 0.3mm. In terms of setting time, Dangote cement took longer time to finally set than Ashaka and BUA Portland cements. All the cement samples tested adhere to the required standard as specified by the British standard Institute (BS, 4550, 1978) which states that the individual cement expansion should not exceed 10mm. Based on the results of the study, it was recommended that: the three cement companies 'products are good for construction of any building in Nigeria and the world over, hence, the quality of production by the three companies meet the required standard as spelt out in the BS.

Keywords: Portland cement, setting time test, soundness test

### INTRODUCTION

Cement is the widest known building material in the construction industry. It is a grounded powder used to bind solid fragments or masses of solid matter together

<sup>1</sup> hangulu@atbu.edu.ng; Phone No: +2347066996272

<sup>2</sup> honestabba6@gmail.com

<sup>3</sup> ismailhamzafaskari@yahoo.com

<sup>4</sup> auwal992@yahoo.com

<sup>5</sup> odesanmiatinuke@gmail.com

to form a whole substance for the purpose of building. For example, it is used in making building blocks and concretes. Cement is produced in different forms namely: ordinary portland cement (OPC), portland pozzolana cement, rapid hardening portland cement, extra rapid hardening cement, low heat cement, sulphate resisting cement, quick setting cement, blast furnace slag cement, high alumina cement and white cement (Hanson Heidelberg Cement Group, 2020). Among the different forms of cement, Portland cement is the most widely used in Nigeria. Portland cement was developed in 1882 by Joseph Aspin, it derived its name from Portland limestone in Dorset because of its resemblance to this rock after hydration has taken place in it. Portland cement is defined as a finely grounded powder which when mixed with water develop a chemical reaction which produces a hard and strong binding medium for the aggregate in concrete (Lea, 2009). Similarly, portland cement is also defined as the product obtained by pulverizing clinker, consisting of hydraulic calcium silicates to which some calcium sulfate has usually been provided as an inter-ground addition (American Concrete Institute, ACI, n.d.).

The chemical reaction by the cement is in the form of hydration which is in its early stage while the cement is still plastic to gives the concrete its cohesive properties. The finer the cement, the more area of contact the particle has. This will therefore, result to more reaction between the cement and the water when in contact, it will illicit more hydration to be achieved (Lea, 2009). This development will lead to the release of high heat of hydration and the generation of high strength by the cement paste. The fine cement particles are also more cohesive and combine better with concrete aggregates. The hydration process of cement results in the stiffening of the cement pastes which is the setting of cement paste as the cement becomes rigid (Neville & Brook, 2012). Setting time of cement is the time required for stiffening of cement paste to defined consistency (The Constructor, n.d.). There are two stages of setting time of cement paste, the first stage is the initial setting time which is the beginning of the stiffening of the cement paste, this occurs between 30-45 minutes for Ordinary Portland Cement (OPC) (Kohli, 2017). While the second stage is the final setting time which is the time when the paste completely loses its plasticity. According to IS 403: 1988, it should not be greater than 375–600 mins for OPC (Kohli, 2017). The time between the mixing of cement with water and the occurrence of initial and final setting time is key to take note of. The cement supposed to maintain its size, especially its volume. Initial setting time test is important to facilitates the transportation, placing and compaction of cement concrete (Kohli, 2017). The author further affirmed that final setting time period facilitates safe removal of form or scaffolding. When a set cement paste increases in size especially by excessive expansion the cement is said to be unsound cement (Neil & Dhir, 2006). Soundness refers to the ability of cement to shrink upon hardening (Civil Engineering, n.d.). Sound cement which its paste has set should not expand so much as to be physically vary in appearance before setting (Nigeria Industrial Standards 444-1, 2003). Good quality cement retains its volume after setting without delayed expansion, which is caused by excessive free lime and magnesia (Civil Engineering, n.d.). However, the use of unsound cement in concrete production could lead to cracking and disintegration of aggregates (Nigeria Industrial Standards 444-1, 2003). In a related development, Civil Engineering (n.d.)

affirmed that unsoundness of cement may appear after several years, therefore, tests for ensuring soundness of cement must be able to determine that potential.

Cement being one of the main constituents of concrete, its chemical properties affect the properties of the concrete produce from it. The characteristics of cement determine to a large extent the quality of concrete produced with it (Hewlett, 2008). For a qualitative concrete to be produced, the cement to be used should be of good quality. Therefore, there is need to study the characteristics and quality of the cement used in concreting. In this study, Portland cements produced by three cement companies in Nigeria were subjected to two different tests, namely: soundness and setting time tests. the essence was to determine their extent of compliance to the code requirements (British Standard Institutes, BS 4550, 1978) The suitability of the cements will be measured based on the provisions and method of test given in the British standard for Portland cement. It is worthy to note that, the three cement companies under study were having issues of quality of their products. This is because the end users are switching from one company to the other which indicated their inconsistency in using these cement products. this prompted the researchers to conduct this study with a view to comparing their soundness and setting time of the three portland cements.

### **Statement of the problem**

For quite some times in Nigeria, the news of collapsed building has been forming the headlines of Nigerian newspapers, some of the reasons for the collapsed buildings were attributed to the quality of materials used, the workmanship, as well as the integrity of professionals that handled the projects. According to Chindo and Obi (2015) buildings collapse occurred due to human errors such as faulty design, faulty construction, and use of substandard building materials, negligence, omissions, ignorance, quackery, corruption and sabotage. Portland cement is one of the key materials used in the construction of building in Nigeria. Soundness and setting time are some of the important properties needed in cement, the absence of these properties may lead to defects in building construction. This study therefore, was carried out to test the soundness and setting time of portland cement produced by three cement companies in Nigeria.

### **Purpose of the study**

The main purpose of this study was to investigate the soundness and setting time of Portland cement produced by three companies in Nigeria. Thus: Ashaka, Dangote and BUA cements companies. Specifically, this study sought to:

- i. Examine the soundness of Portland cement produced by Ashaka, Dangote and BUA Nigeria Plc.
- ii. Examine the setting time of Portland cement produced by Ashaka, Dangote and BUA Nigeria Plc.
- iii. Explore views of the users of Ashaka, Dangote and BUA Portland cement on soundness and setting time of the cements.

### **Research Question**

The following research questions guided the study;

- i. What is the soundness of Portland cement produced by Ashaka, Dangote and BUA Nigerian Plc?
- ii. What is the setting time of Portland cement produced by Ashaka, Dangote and BUA Nigerian Plc?

## LITERATURE REVIEW

Soundness Test of cement is very important, it measured the expansion of cement after it starts setting (Mahajan, 2019). The author further affirmed that certain cement has been found to undergo a large expansion after setting causing disruption of the set and hardened mass. This expansion of cement can cause serious problems for the durability of structures when such cement is used.

Soundness Le Chatelier 10mm. Apparatus, Autoclave 0.8% 0.8% 0.8%. Setting time Vicat apparatus, Initial (min) 30. Final (max) 600. Knowing the initial setting time is important in estimating free time for transporting, placing, compaction and shaping of cement paste (Mansur, n.d.). Ige (2013) remarked that all the cement brands studied meet the requirement of BS 12, (1996) section 12, which recommends an expansion of not more than 10mm for Ordinary Portland Cement. The use of Le Chatelier apparatus, expansion should not be more than 10mm (IS 4031, Part 3 as cited in Patel & Mohanty, 2016). Soundness Test of cement is very important because it measures the expansion of cement after it starts setting (Mahajam, 2019). The author further affirmed that certain cement has been found to undergo a large expansion after setting causing disruption of the set and hardened mass. This expansion of cement can cause serious problems for the durability of structures when such cement is used.

The setting times of cement are categorized into two, namely: Initial and final setting time. Initial setting time is that time period between the time water is added to cement and time at which 1 mm square section needle fails to penetrate the cement paste, placed in the Vicat's mould 5 mm to 7 mm from the bottom of the mould (Patel & Mohanty, 2016). According to the authors, they described final setting time as that time period between the time water is added to cement and the time at which 1 mm needle makes an impression on the paste in the mould but 5 mm attachment does not make any impression. It is essential that cement set neither too rapidly nor too slowly. In the first case there might be insufficient time to transport and place the concrete before it becomes too rigid. In the second case too long a setting period tends to slow up the work unduly, also it might postpone the actual use of the structure because of inadequate strength at the desired age.

## METHODOLOGY

The study adopted explanatory sequential mixed method research design for this study. This design involves the use of both quantitative and qualitative approach. The quantitative approach includes the use of laboratory experiment to gather the quantitative data. While the qualitative aspect of the study involves the use of semi structured interview to sample the opinion of seven bricklayers that frequently used the three cement companies 'products. The study therefore, set out to investigate the soundness and setting time of Portland cement of three companies

in Nigeria. Thus: Ashaka, Dangote and BUA cement companies. The samples of the Portland cement from the three companies were sourced from the dealers for laboratory analysis. These were done in accordance with the requirement of BS 4550 which is 500g (using a weight balance) of cement mixed with distill water to give a paste of standard consistency, the specimen was moulded into one or two layers, each layer being compacted with the thumb or forefinger by pressing the paste in the corners, around the reference inserts, and along the surfaces of the moulds until a homogeneous specimen was obtained. During the operations of mixing and moulding of the cement paste, the hands were protected by wearing hand gloves.

This research also used a qualitative research approach in which the data were collected by means of semi-structured interviews using seven bricklayers randomly selected that uses the companies 'products. This type of interview was adopted for the study to give these users the opportunity to express their views on these three different kinds of cement. According to Hamza, Musta'amal and Kamin (2017) semi-structured interviews could be used across disciplines as participants are given the opportunity to speak out their standpoints on the current research issues.

The interviews were guided by the research objective 3 and has two sections: A and B. Section A seeks information on the users 'demographic peculiarities and section B is the protocol of the interview of their views on the soundness and setting time of the three types of cements. Finally, the outcomes of the contextual data gathered from the interviews were transcribed and analysed inductively (Maykut & Morehouse, 1994) using a content analysis technique (Merriam, 2009) manually. This technique was used for the study because it is one of the best qualitative approaches used to analyse contextual data (Creswell, 2014).

#### **Laboratory apparatus for soundness**

The laboratory apparatus for soundness test includes: Le-Chatelier apparatus conform to IS:5514-1969, weight balances whose permissible variation at a load of 1000g is +1 or -1, water bath, two glass sheets, center ruler and gauging trowel conforming to IS: 10086-1982.

#### **Laboratory apparatus for setting time**

The apparatus for setting time test includes: Vicat apparatus conforming to IS: 5513-1976, weight balances whose permissible variation at a load of 1000g is +1 or -1, gauging trowel conforming to IS: 10086-1982.

#### **Method of data collection**

The study adopted explanatory sequential mixed method research design for this study. In this design, quantitative data was collected and analyzed followed by qualitative data collection.

#### **Determination of soundness test**

Cement paste of standard consistency was used to fill a Le Chatelier mould, which has two indicator needles. After filling the mould with the cement paste, the distance ( $d_0$ ) in millimeters, between the needles was measured and recorded. The filled Le Chatelier mould was heated in boiling water for 30 min., and after allowing to stay in a humidity cabinet for 24 hours, the soundness was later determined by



measuring the new distance (df) between the two needles. The soundness was obtained by the difference,  $df - d_0$ .

### Determination of Setting Time

The initial and final setting times were determined using the Vicat needle (NIS 447:2003). The needle which is attached to the Vicat apparatus was calibrated by lowering it to rest on the base plate of the instrument and then adjust the pointer to read zero on an attached scale. The needle was later raised to stand in position.

The cement pastes which have gone through standard consistency test was transferred into an open mould on the base plate of the Vicat instrument. The needle was released to penetrate vertically into the paste. When penetration ceased, the scale on the Vicat instrument was read and the time recorded as the initial setting time,  $T_0$ . The mould was later inverted, and the needle was attached with a ring, and allowed to rest on the reverse face of the paste. The final setting time  $T_f$  was recorded as the time, the reading started from the onset of experiment when the ring failed to make a mark on the reverse surface of the sample.

## RESULT AND DISCUSSION

### Research question 1

What is the soundness of Portland cement produced by Ashaka, Dangote and BUA Nigerian Plc?

Result of soundness test

Total weight of cement used = 500g at water cement ratio of 5.0

Ashaka cement; first expansion = 2.0mm, second expansion after 30 minutes heating = 2.2mm

Therefore:  $2.2\text{mm} - 2.0\text{mm} = 0.2\text{mm}$

Dangote cement; first expansion = 2.0mm, second expansion after 30minutes heating = 2.1mm

Therefore:  $2.1\text{mm} - 2.0\text{mm} = 0.1\text{mm}$

BUA Cement; first expansion = 2.1mm, second expansion after 30minutes heating = 2.4mm

Therefore:  $2.4\text{mm} - 2.1\text{mm} = 0.3\text{mm}$

**Table 1: Result of soundness test conducted on the three cement companies**

Brand of Cement	Expansion of Cement	Code Requirement
Ashaka cement	0.2mm	Expansion not to exceed 10mm
Dangote cement	0.1mm	
BUA cement	0.3mm	

Table 1 shows the results of the soundness test carried out on the samples of the three cement companies. Ashaka Portland Cement recorded 0.2mm, Dangote

Portland Cement recorded 0.1mm and BUA Portland Cement 0.3mm. These were the outcome of the laboratory test to ascertain the expansion of the cement samples of the three companies after heating for 30 minutes. This implied that the Portland Cement from the three companies fell within the code requirement of portland cement not exceeding 10mm expansion limit of standard portland cement. This result agreed with Nigeria Industrial Standards 444-1 (2003) and Civil Engineering (n.d.) in their separate studies stated that sound cement which its paste has set should not expand so much as to physically vary in appearance before setting, as the effect of unsound cement manifest itself after several years which is usually not good for any construction work. This result also agreed with Mahajan (2019) who stated that soundness Test of cement is very important, it measured the expansion of cement after it starts setting. In the author's line of argument, he affirmed that certain cement has been found to undergo a large expansion after setting causing disruption of the set and hardened mass. This expansion of cement can cause serious problems for the durability of structures when such cement is used. From the results of this study, it implies that all the cement samples tested (i.e. Ashaka, Dangote & BUA cements) adhere to the required standard as specified in British Standard Institutes, BS 12: part 1 (1996) which stated that the individual expansion of any cement should not be more than 10mm in terms of soundness.



Figure 1: Pie Chart displaying the Percentage of Cement Expansion by the three Cement Companies

Figure 1 shows the pie chart results of the three cement companies in percentages. BUA Cement recorded 50%, followed by Ashaka Cement with 33% and Dangote Cement with 17% respectively. Dangote Portland Cement has the least expansion, while BUA Portland Cement has the highest expansion of the three cement companies. The variation in the expansion of the three cement samples are based on the constituent materials that facilitate the slow or high rate of their expansion. However, despite the variations in their expansion rate, they all fell within the code requirement of not exceeding 10mm expansion. This result is in agreement with the result of Ige (2013), Patel and Mohanty (2016) in their separate studies stated that in using Le Chatelier apparatus, expansion of cement should not exceed 10mm (IS 4031, Part 3).

### Research Question 2

What is the setting time of Portland cement produced by Ashaka, Dangote and BUA Nigerian Plc?

Result of setting time test

Setting time of Ashaka cement

The total weight of sample = 500g of cement water cement ratio of 5.0

**Table 2: Result of setting time test conducted on Ashaka Cement Nig. Plc**

Time	Initial Setting	Final Setting
First 15 minutes	0.01mm	First 14.1mm
Second 15 minutes	14.0mm	Final drop 15.0mm

30minutes = 14.01mm

3hours = 29.1mm

Therefore: The initial setting is 30minutes

The final setting is 3hours.

Setting time of Dangote cement

The total weight of sample is 500g of cement water cement ratio 5.0

**Table 3: Result of setting time test conducted on Dangote Cement Nig. Plc**

Time	Initial setting	Final setting
First 15 minutes	0.00mm	First drop 14.0mm
Second 15 minutes	11.02mm	Final drop 14.2mm
Third 15 minutes	11.04mm	

45minutes 22.42mm

3:30minutes 28.2mm

Therefore: The initial setting time is 45 minutes

Final setting time is 3:30 minutes

Setting time of BUA cement

The total weight of sample = 500g of cement water cement ratio 5.0

**Table 4: Result of setting time test conducted on BUA Cement Nig. Plc**

Time	Initial setting	Final setting
First 15minutes	0.02mm	First drop 14.1mm
Second 15minutes	14.2mm	Final drop 15.2mm

30minutes = 14.22mm

3hours = 29.3mm

Therefore, the initial setting time is 30 minutes

The final setting time is 3 hours

**Table 5: Summary of result of setting time test for the three Nigeria cement companies**

Brand of cement	Initial setting	Final setting	Code requirement
Ashaka cement	30 minutes	180 minutes	IS standard
Dangote cement	45 minutes	225 minutes	"
BUA cement	30 minutes	180 minutes	"

Table 5 shows the summary results for both initial and final setting times of the three cement companies. Ashaka and BUA Portland cement takes 30 minutes for their initial setting time and 180 minutes for their final setting time to be established. While Dangote Portland cement takes 45 minutes for its initial setting time to be established and 225 minutes for the final setting time to be established. The findings are in conformity with IS standard code requirement. The timing of 30 and 45 minutes for initial setting time is sufficient enough for the utilization of cement mortar and concrete to be transported, placement and/or compaction before it finally set. These results agreed with the positions of The Constructor (n.d.) and Kohli (2017) in their separate studies affirmed the important of initial setting time as it facilitates the transportation, placing and compaction of green cement mortar/concrete. While final setting time period facilitates safe removal of form or scaffolding.

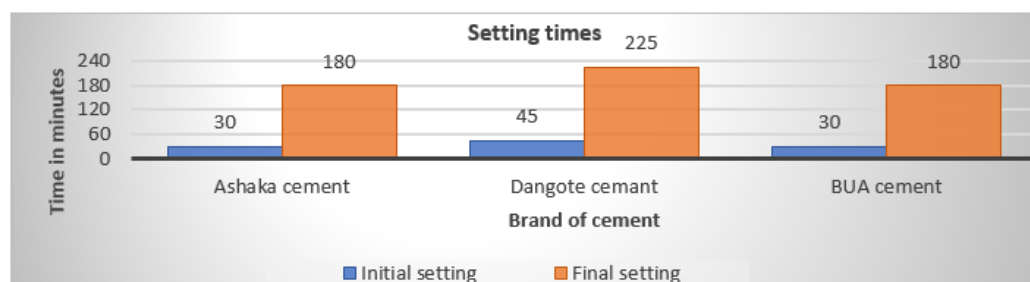

Figure 2: Graphic Results of the Initial/Final Setting Times for the three Cement Companies

### Research question 3

#### *Classic responses by the users*

The documentation of typical responses was built on the analysis of two key issues which include soundness and setting time of three different cement companies under study. The users' views were recorded during the interview sessions. Generally, the users have similar characteristic of using all the three companies' cement (Ashaka, Dangote & BUA) but their responses appeared to be different. To this end, the major findings of this research were summarised in the following order: All the 7 users acknowledged that the soundness and setting time of Ashaka cement indicated stability in the volume of change in the process of setting out and hardening. This supersedes that of BUA which five users indicated its soundness and setting time as stable and lastly the Dangote cement which 3 users reported its soundness and setting time as stable.

## CONCLUSIONS

Based on the findings of this study, it was concluded that Portland cement being the main binding constituents of concrete, its quality affects the properties of the concrete produce from it. For a qualitative concrete to be produced, the cement to be used should be of good quality. Therefore, there is need to study the

characteristics and quality of the cement used in the production of concrete. Soundness and setting times are some of the important qualities needed in the cement, the lack of these qualities may lead to defects in building construction. This study, was carried out to analyze the soundness and setting times of Portland cement of three cement companies in Nigeria, thus: Ashaka cement, Dangote cement and BUA cement. The outcome of the laboratory analysis revealed that the three cement companies 'products complied with the code requirement for standard cement for construction work in Nigeria and the world over. Conclusively, it is imperative to note that this study is not sponsored. The analysis revealed that the three cement companies 'products complied with the code requirement for standard cement for construction work in Nigeria and the world over.

## REFERENCES

- American Concrete Institute (ACI, 2021). Definition of portland cement. Retrieved from: <https://www.concrete.org/tool/frequentlyaskquestions.aspx?faqid=671>
- British Standard Institutes, BS 4550 (1978). Methods of testing cement. London: Her Majesty's stationery office, United Kingdom
- British Standard Institutes, BS 12: Part 1 (1996). Methods of testing cement sampling. London: British Standard Institution.
- Chindo, I. G. & Obi, N. I. (2015). Building collapse in Nigeria: the causes, effects, consequences and remedies. *International Journal of Civil Engineering, Construction and Estate Management* 3(4), pp.41-49. Retrieved from: <http://www.eajournals.org>
- Civil Engineering (2019). Properties of cement physical and chemical. Retrieved from: <https://civiltoday.com>
- Creswell, J. W. (2014). *Research design: Qualitative, quantitative, and mixed methods approaches*. (Fourth ed.) Thousand Oaks, California: Sage publications, Inc.
- Hewlett, P. C. (2008). *Cement admixtures: Uses and applications*, 2nd edition. London: Longman Group. Retrieved from: <http://www.uomisan.edu.iq>
- Hanson Heidelberg Cement Group (2020). Types of cement used in the construction industry. Retrieved from: <https://www.hanson.my/en/types-cement-construction.industry>
- Ige, O. A. (2013). Comparative analysis of portland cements in Nigeria. *International Journal of Engineering Research and Technology (IJERT)* 2(3). Retrieved from: <https://www.ijert.org>
- Kohli, S. (2017). What is the significance of setting time of cement? Retrieved from: <https://www.quora.com>
- Lea, F. M. (2009). *The chemistry of cement and concrete*. London: Edward Arnold
- Mahajan, B. (2019). Soundness test of cement procedure and results. Retrieved from: <https://civiconcepts.com/blog/soundness-test-of-cement-procedure-and-results>
- Neville, A. M. & Brook, J. J. (2012). *Concrete Technology*. Essex: Longman Ltd. United Kingdom
- Neil, J. & Dhir, R. K. (2006). *Concrete, civil engineering materials*. London: Macmillan
- Nigeria Industrial Standards 444-1 (2003). *Cement composition, specifications and conformity criteria for common cements*

- Patel, H. & Mohanty, B. (2016). Comparative analysis of chemical and physical properties of mini cement plant and major cement plant. *Journal for Research*, 2(10), pp 21 – 23. Retrieved from: [https://www.academia.edu/30730811/Comparative\\_Analysis\\_of\\_Chemical\\_and\\_Physical\\_Properties\\_of\\_Mini\\_Cement\\_Plant\\_and\\_Major\\_Cement\\_Plant](https://www.academia.edu/30730811/Comparative_Analysis_of_Chemical_and_Physical_Properties_of_Mini_Cement_Plant_and_Major_Cement_Plant)
- Swamy, R. N. (2001). *Blended cements in construction*. Proceedings of the international conference on blended cement in construction. UK: Sheffield



---

# CONCEPTUAL FRAMEWORK FOR WHOLE-LIFE COST DATA TRANSFORMATION AND MODEL SELECTION IN THE BUILDING SECTOR

Ibrahim, A. M.<sup>1</sup>, Bala, K.<sup>2</sup>, Ibrahim, A. D.<sup>3</sup> and Zubairu, I. K.<sup>4</sup>

<sup>1,2,4</sup>*Department of Building, Faculty of Environmental Design, Ahmadu Bello University, Zaria, Nigeria.*

<sup>3</sup>*Department of Quantity Surveying, Faculty of Environmental Design, Ahmadu Bello University, Zaria, Nigeria*

Data for Whole Life Costing (WLC) is obtained from multiple sources in different formats. This inhibits data sharing between built-environment costs professionals thereby adding to data related problems often associated with WLC. This paper presents a proposed framework for mapping WLC data to models, as well as transforming data into a variety of formats. Framework components, variables and processes were identified from literature and synthesized into a conceptual framework. Also, a matrix of transformation logic was produced to compliment the model selection process. Seven data related scenarios and possible decisions/courses of actions were derived from the framework. Additionally, seven useful data types and fourteen data formats were identified. Of the fourteen formats random statistical data, probability density functions and fuzzy membership functions were found to be the most important in terms of transformability ranking. The framework provides strategic decision guide for cost professionals during the preparation of WLC data and the selection of a suitable model, while the transformation processes provides a procedural guide for converting data into different formats. The findings set the stage for the development of transformation and integration algorithms to support computer coding, and the design and implementation of a database that would facilitate the storage and retrieval of data in multiple formats.

Keywords: data integration, data sharing, data transformation, whole life cost data, whole life cost models

## INTRODUCTION

Sustainable development agenda requires building projects to be economically efficient so that, they are free of under or over investment over their life cycle. An indispensable tool that helps in the evaluation of economic sustainability of a building is the Whole Life Costing (WLC) technique (Boussabaine & Kirkham 2004; Ellingham & Fawcett 2006). As a technique, WLC is used for the assessment of the

---

<sup>1</sup> alibramak@gmail.com

<sup>2</sup> balakabir@yahoo.com

<sup>3</sup> adibrahim2@yahoo.com

<sup>4</sup> ibrahkazu@gmail.com

cradle-to-grave cost of a building or its part, component or system. It represents the present value of the sum of the initial, operating, maintenance, and terminal costs of a built asset. It is essentially used as a decision-making tool to facilitate the selection of the best option (design, component, building, system etc) from a host of competing alternatives; for design optimisation; and for budgetary purposes (Flanagan & Jewell 2005; Hoar 2007). A typical WLC requires cost, physical, economic, and performance data. These data come from diverse sources in different forms and varying characteristics like tangibility, certainty and availability (Kishk et al. 2003). The application of the technique in especially the developing countries, despite its usefulness, is retarded by a number of challenges. Higham, Fortune, and James (2015), and Opawole et al. (2020), identified these challenges to include; data, client, process, politics, government, practice, and tools related.

The data related problem centres on data scarcity, difficulty in data sharing, and inconsistent databases. Firstly, the dearth of reliable historical data makes WLC expensive to conduct due to cost of data collection which reduces confidence in the reliability of the results (Al-Hajj et al. 2001). Secondly, data for WLC is elicited from different sources and in different structure, which necessitates data adjustment in order to bring it to a common basis in terms of type, structure, time, and location. Such adjustment is imperative to data sharing between different models, if model-data mismatch is to be avoided (Saridaki, Psarra, & Haugbølle 2019). Data adjustment or transformation is a complex process and unless it is simplified, data elicitation and processing will remain tedious thereby aggravating the data scarcity problem. Thirdly, existing databases are inconsistent and inaccurate. Al-Hajj et al. (2001) described them as 'constructed' rather than 'historical-based' with data background information often not recorded making them unreliable.

Kishk et al. (2003) underscore the importance of data transformation during the selection of a modelling technique. They proposed an integrated framework for WLC that facilitates the selection of an appropriate modelling technique on the basis of data tangibility, availability and certainty. The framework however considers only the two extremes of data availability (available data, and no data), eliminating possibilities of having incomplete data as suggested by Ilg et al. (2017).

The aim of this paper is to develop a WLC framework that facilitates data transformation, as well as the identification and selection of an appropriate WLC model and data format. It is strongly believed that built-environment cost professionals will find the framework a useful guide for data/model matching, data transformation, and sharing as well as providing the basis for the development of a robust WLC database.

## **LITERATURE REVIEW**

### **Purpose of WLC**

Whole Life Costing (WLC) can be described as a technique that facilitates the systematic computation of the total cost of an asset or its part, from concept to its end-of-life (Hoar 2007; Norman 2007). It is essentially used to aid decision-making when choosing between competing alternatives (building investment options,



design alternatives, systems, or components); optimisation of designs, performance, system, or components; and forecast of costs for budgetary purpose (Kishk et al. 2003; Hoar 2007).

### **Data requirement for WLC**

Data for WLC can be both quantitative and qualitative. Quantitative data is numerical in nature and represents cost data (like initial, operating, maintenance repair, and terminal cost), physical data associated with dimension of a building (e.g. gross floor area, floor to ceiling height, external perimeter etc), economic data (like interest rate, inflation rate, discount rate etc), and performance data (like maintenance cycles, life expectancy, occupancy time, electricity consumption, water consumption, gas consumption etc). These data are useful in WLC using quantitative techniques like Net Present Value (NPV) (Kishk et al. 2003; Flanagan & Jewell 2005). Qualitative data on the other hand is subjective and often derived from expert judgement/opinion (e.g. condition, quality, aesthetics, comfort and maintenance ratings, intangible costs and benefits). These kinds of data are used in qualitative WLC using weighted evaluation techniques (Norman 2007). Dell'Isola and Kirk (2003) proposed a pair-wise weighted evaluation technique suitable for analysing qualitative WLC data. Kishk (2002) and Kishk, Al-Hajj, and Pollock (2002) modified the technique using Fuzzy Set Theory (FST). Norman (2007) noted that, it is imperative to have a blend of both quantitative and qualitative approach so that computed WLC results can be moderated with professional judgement and experience.

### **Data related challenges**

The dearth of historical data has been reported by many authors (Flanagan & Jewell 2005; Higham, Fortune, & James 2015) and remains the most important challenge to WLC. In an attempt to mitigate the scarcity problem, Kishk and Al-Hajj (2000) developed an innovative FST based approach that utilizes expert opinion and judgement. Another data related problem is the lack of uniformity in the source, type and structure of WLC data. This means that before data can be used in a different setting, substantial adjustments (often complex and costly) must be made to normalise and express it on a common scale. In order to simplify the adjustment process, there is the need to automate the process so that data can easily be converted and shared for use in different environment.

Another data related problem resides with the limitations of existing databases. These databases which are supposedly designed to provide a system that simplifies WLC data storage and retrieval are rather inconsistent. Al-Hajj et al. (2001) argued that the databases are based on "expert opinion", trades publication data, and manufacturers 'data, and that, background information and measures of uncertainty are often lost during data storage as the context information on the data is often not recorded. This is particularly a problem as data relating to a proposed project is often generated from multiple sources.

### **Quantitative WLC data formats**

Quantitative data used in WLC comes in different formats depending on availability and nature of uncertainty. Crisp, single or point data is a discrete and precise value, free of variability and thus used in deterministic WLC (Boussabaine & Kirkham 2004; Ashworth & Parera 2016). Where the nature of variability in the data is not

clear, interval data can be used to represent the uncertainty. Range of values are used to mark the lower and upper bounds of the data. A variable represented by interval data can take any value within the bound (Bruns, Paredis, & Ferson 2006). WLC can then be done deterministically using interval arithmetic. Another format is the three-point data that marks the lower and upper bounds, as well as the best estimate of the data (Boussabaine & Kirkham 2004). Sensitivity analysis can be performed within the data bound to identify the most sensitive variables (Flanagan et al. 1987). A variant of the three-point data introduced by Dell'Isola and Kirk (2003) for use in Confidence Index (CI) approach to WLC, is conditional, and require the data to meet dual criteria. First the high and low 90% must be obtained from same source as the best estimate and should represent knowledgeable estimate rather than guess work. Second, the difference between the present values of the best estimates and the present value of the lower and upper 90% bounds must be within 25% of each other. The approach is designed around probability theory and assumes uncertainty in WLC data to be normally distributed, and the lower and upper 90% bounds to correspond to the true 90% mark on a normal probability distribution.

Where sufficient sample of historical data is available, objective frequency distributions can be generated and a suitable representative probability distribution identified (Kishk & Al-Hajj 2001). Boussabaine and Kirkham (2004) identified some popular PDF as normal, lognormal, beta, Weibull, Pareto, exponential, and gamma. The PDF can then be used in simulation models. Alternatively, such data can form the basis for developing regression models (Ashworth & Parera 2016). Statistical data may however turn out to be non-random which makes it unsuitable for stochastic modelling. In such a situation, other modelling techniques like Artificial Neural Network (ANN), Genetic Algorithms (GA) and Fuzzy Set Theory (FST) or their combination may be deployed. Ross (2004) demonstrated how fuzzy sets can be generated through intuition, inference, rank ordering, ANN, GA, and inductive reasoning.

Sample size in statistics is an important determinant of the kind of analysis to apply. Spiegel and Stephens (1999) noted that, small sampling theory requires a sample size of less than thirty for its application. In fact, Stephen and Berenson (2005) showed that, the central limit theorem holds where the sample size is at least thirty for a population that is not normally distributed.

Where historical data is not sufficient to form a definitive distribution, as a result of say missing data, heuristics may be used to augment the data (Goh et al. 2010) based on expert judgement. Data augmentation techniques like Convolution Neural Networks (CNN) (Zheng et al. 2020), Bayesian data augmentation approach (Tran et al. 2017), and Markov-chain Monte Carlo (van Dyk & Meng 2001) have been successfully used in the fields of medicine, imagery, music amongst others. There usability for WLC needs to be explored.

Subjective probabilities are used where WLC data is not available. These probabilities are systematically collected from experts and a subjective PDF formulated. The PDF can take the form of uniform, triangular, and trapezoidal density functions (Seeley 1998). A procedure for the development of subjective probabilities has been recommended by Galway (2007). Wang, Chang and El-

Sheikh (2012) have demonstrated the development and use of subjective probabilities during simulation of WLC.

Another form of data used in WLC is linguistic variables. These are expert statements that are either ambiguous, vague or imprecise. Such statements are best expressed using fuzzy numbers (Zimmermann 2001; Ross 2004). Fuzzy numbers can take different shapes like rectangular, triangular, trapezoidal and Gaussian. Kisk and Al-Hajj (2000) have demonstrated the application of Fuzzy Set Theory in WLC of building projects.

### **WLC Models**

A model is a prototype of a real object or its characteristics, procedure, or system (Anderson, Sweeney & Williams 2004; Fellows & Liu 2007). The goal is for the prototype to closely represent the real object. Models come in different forms depending on how they mimic reality. A model that is a replica of a real object is called iconic model (Kirkham 2015). Analog models are physical in form but are not exact replica of the object they represent. Symbolic or mathematical models represent a scenario with a system of symbols, logical or mathematical expressions (Kirkham 2015). Another classification is based on the transparency of model's internal structure. In this class models can be either black-box or white-box. The internal structure of a black-box model is opaque, that is not completely known to the modeller. Such models use some form of heuristics to generate output based on some given input data. Examples are Artificial Neural Networks (ANN), and Genetic Algorithms (GA). The internal structure of a white-box model is transparent in the sense that, it is completely known to the modeler. Symbolic models are transparent as their structure is known to the modeller (Fellows & Liu 2007).

Two broad classes of cost models have been identified by Skitmore and Marston (1999). These are cost-product and cost-process models also referred to as 'Designers' cost models' and 'Constructors' or 'production cost models' respectively by Ashworth and Parera (2016). The cost-product model relies on information from completed projects to model cost of proposed developments. Cost-process models on the other hand mimic construction process based on operations or activities often at a detailed level, to model cost of proposed projects (Kirkham 2015). Another important classification of cost model is based on the way uncertainty is treated. Deterministic models assume perfect information. They take precise cost data as input and produce output that is interpreted as certain (Ashworth & Parera 2016). The second group is stochastic model which recognise reality to be full of uncertainty and thus model cost as a random parameter based on probability theory (Bowen, Wolvart & Tailor 1987; Ashworth & Parera 2016). The third group expresses uncertainty as non-random and model cost in terms of fuzzy sets or heuristics (Boussabaine and Kirkham 2004).

The purpose of WLC models is to ease process complexity and improve efficiency in achieving the core objectives of WLC. Boussabaine and Kirkham (2004) identified three WLC modelling techniques. They include deterministic, stochastic and FST based techniques. Kim, An, and Kang (2004) also described how regression analysis can be used to model the relationship between variables in WLC.

### **Uncertainty and risk in WLC data**

The desire to predict decisions, performances and costs that will occur many years into the future, coupled with the dearth of reliable historical data makes WLC prone to uncertainty (El-Haram et al. 2007). Zimmerman (2001) described uncertainty as the lack of quantitative and qualitative information needed to adequately prescribe or predict both deterministically and numerically the characteristics of a system. He further identified the causes of uncertainty as lack of information, overabundance of information, conflicting evidence, ambiguity, measurement error, and belief. Huijbregts et al. (2003) identified three types of uncertainty in WLC: parameter (data related uncertainty), model (uncertainty in mathematical relationship) and scenario (uncertainty in normative choices).

Parametric uncertainty is data related, and occurs due to lack of information, overabundance of information, measurement error, ambiguity, and unrepresentative data (Huijbregts 1998; Zimmerman 2001). Goh et al. (2010), further classified parametric uncertainty into aleatory and epistemic. They described aleatory uncertainty as intrinsic variability in data that does not completely vanish with additional information. Epistemic parametric uncertainty occurs primarily due to lack of knowledge on the true value of a parameter and can be reduced with additional information. It is more difficult to assess and thus require new approach (Xu et al. 2012). Oberkampf and Helton (2001) had suggested the need for a modelling approach that will take into account epistemic and aleatory uncertainty in WLC separately, so as to avoid underestimating the overall impact of uncertainty. Scope et al. (2016) identified the sources and nature of parametric uncertainty. They grouped multiple sources of data, estimation error, inherent randomness, and data gaps under aleatory; linguistic vagueness, ambiguity, imprecision, lack of data, and unrepresentative data under epistemic; and data collection error under both aleatory and epistemic. Aughenbaugh and Paredis (2006) described how interval or probability bounds analysis can be used to separate aleatory and epistemic uncertainties.

## **RESEARCH METHOD**

Gregg, Kulkarni and Vinz' (2001) stated that, the development of an information system based on a concept that is rooted in literature, and which solves a problem in a new way at organisational or individual level constitute a research. They noted that, traditionally, research in information systems takes up either a positivist/post positivist or interpretive/constructivist approach. Recent development in information technology makes these paradigms unsuitable for Information systems-based research. This is because the explanations, justifications and methods associated with the paradigms are insufficient for software engineering researches (Deng & Ji, 2018).

Gregg, Kulkarni and Vinz' (2001) proposed a 3-stage framework for information system research, the philosophical paradigm of which they called 'socio-technologist/developmentalist paradigm'. They stressed that, while positivist/postpositivist paradigm focuses on the confirmation of prepositions, the interpretive/constructivist paradigm is concerned with the generation of new concepts and the socio-technologist/developmentalist paradigm is concerned with

the creation of new ideas. The stages of the proposed framework are conceptualisation, formalisation and development.

The conceptual stage is the first and most important stage. This stage involves defining the research problem by grounding it in literature to generate theoretical constructs and define the needs and specification for the research effort. This stage is very important that none of the two subsequent stages can stand as a research without it.

The formalisation phase involves a systematic description of the system concept using mathematical and/or logical technique which helps to avoid misconceptions and misunderstanding about the system. Tools that could be used include flowcharts, unified modelling language, heuristics etc.

The developmental stage involves the generation of prototypes as a proof of concept, proof by demonstration to test the validity of a proposed solution in a controlled environment. Prototyping is an iterative process with each subsequent stage seeking to improve on the success of a previous stage. It aims to assess the feasibility of the design and test the functionality of the proposed system. Typical activities at this stage includes: mathematical modelling and evaluation, math/logic proofs, analytical and numerical modelling, and computational analysis.

This research adopts the 3-stage information systems methodology framework proposed by Gregg, Kulkarni and Vinz´ (2001). Figure 1 is a summary of the research method adopted. The research begins with problem identification narrated in the introduction section. A literature review was then conducted to articulate types, purpose and classifications of cost models, data requirement, data format and transformation, and risk and uncertainty in WLC, which then provides the basis for identifying framework component, processes, constructs and variables that were then synthesized using basic flowchart symbols to design the conceptual framework. It should be noted that, the development stage of the research process is outside the scope of this paper as the intent is to propose a conceptual framework as a first step.

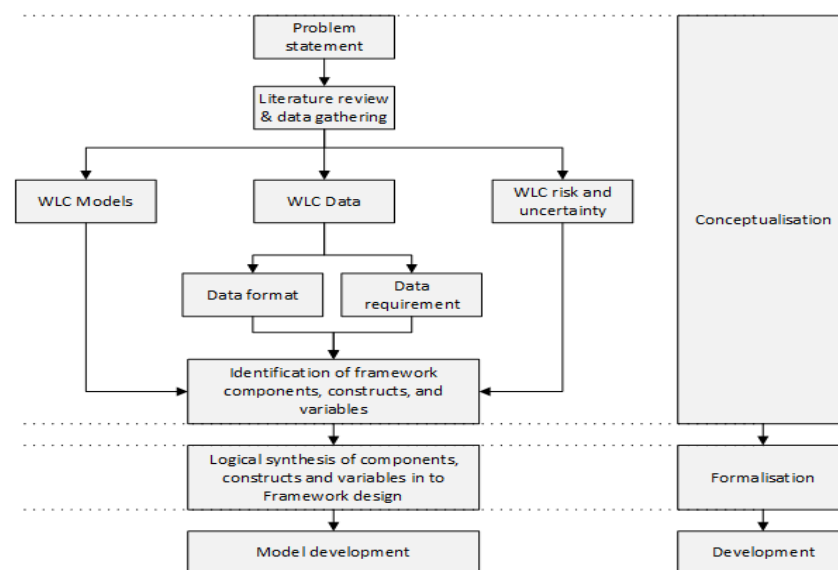

Figure 1: Research Process

## RESULTS AND DISCUSSION

### Model selection framework

Figure 2 shows a flowchart representation of the conceptual framework.

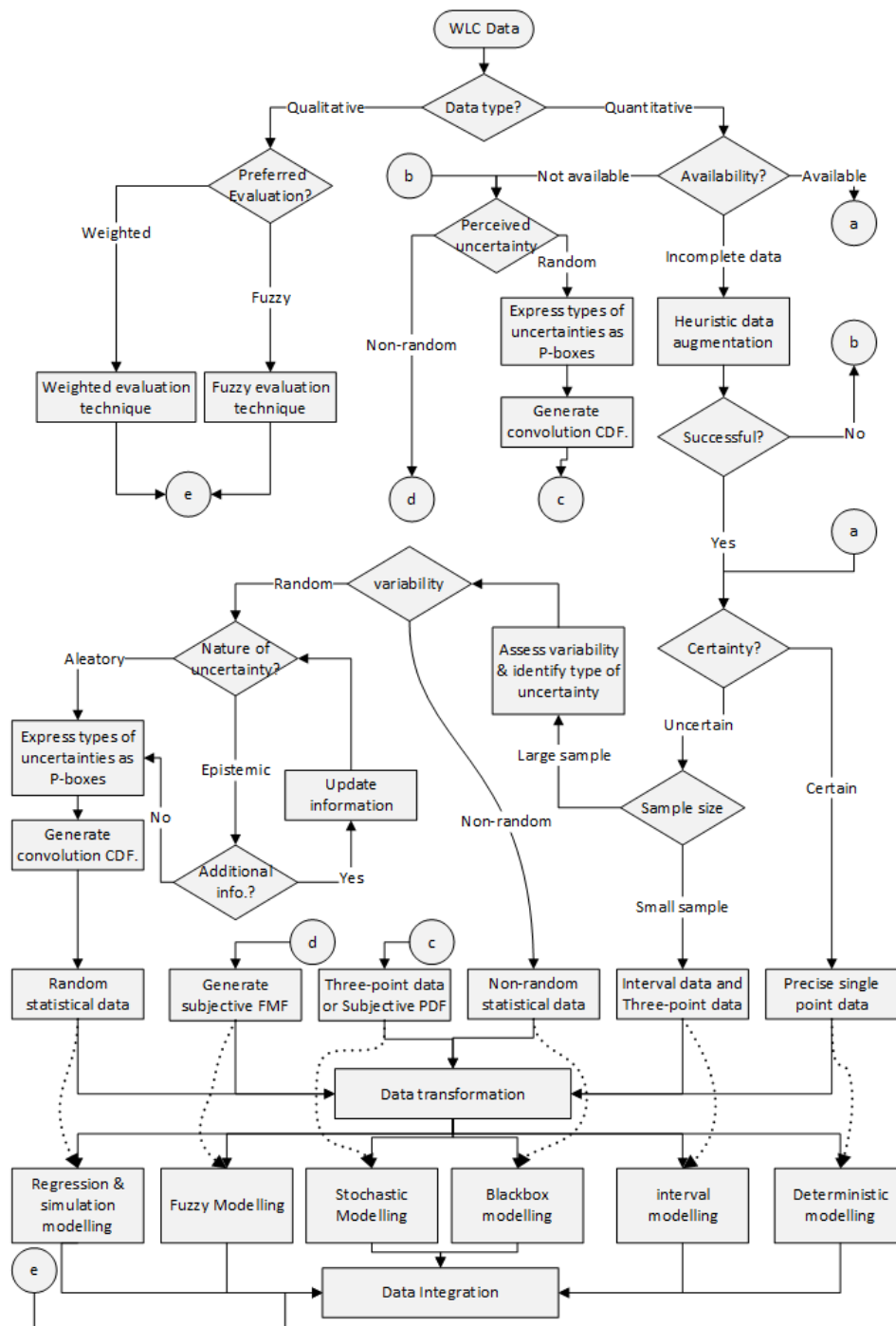

Figure 2: Conceptual framework for data transformation and model selection

In the figure, oval, rectangle, and diamond shapes represents beginning/end of the process, operations, and decisions respectively. Solid arrows show the direction of flow of activities, while dotted arrows show the direction of mapping of data type to modelling technique. The framework portrays seven different scenarios that relates seven quantitative data types to six modelling approaches.

The first scenario is when WLC data is qualitative, the use of standard pair-wise weighted evaluation technique by Dell'Isola and Kirk (2003) or the modified FST-based technique is recommended.

Where the data is quantitative, evaluation is on the basis of availability, certainty, sample size, variability, and nature of uncertainty. The second scenario is where data is available and certain. This scenario is rare in real life given the level of uncertainty associated with WLC data. In this situation however, precise single-point data and deterministic models should be the preferred data format and model respectively.

The third scenario is where quantitative data is available, uncertain, of large sample and random. A frequency distribution should be prepared based on a which a standard PDF can be fitted. If this is done successfully, then, the relevant parametric uncertainties should be identified and assessed as recommended by Goh et al (2010), otherwise the data is treated as non-random.

The fourth scenario is the case where data is available, uncertain, of large sample, and non-random. Non-stochastic analysis involving black-box models like ANN and GA is recommended for this kind of data. Alternatively, fuzzy sets can be generated by classifying and assigning membership values to the data set for use in fuzzy model.

The fifth scenario is where quantitative data is uncertain but of small sample. Small samples of data are not sufficient for constructing a frequency distribution, let alone determining the variability of the data set. This kind of data should be used for interval, three-point estimates, and sensitivity analysis using deterministic models.

The sixth scenario is where quantitative data is available but incomplete. In this situation, data augmentation should be attempted as a first step. Where the data is successfully augmented, then depending on the sample size, scenario four or five can be initiated, otherwise, the situation is treated as the case of unavailable data.

The seventh scenario is where quantitative data is not available. The only option in this situation is to elicit subjective data from professionals. Subjective probabilities or FMF should be obtained from expert opinion and used in stochastic and Fuzzy models respectively.

#### **Data transformation processes**

Table 1 is a summary of data types, data levels, data formats, and applicable transformation procedures.

From the table, seven data types, fourteen data formats, and six data levels can be identified. The data types are: Single-Point data (SPD), Range or interval data (RD), Three-Point Data (TPD), Stochastic Three-Point Data (STPD), Fuzzy Data (FD), Probability Density Function (PDF), and Statistical Data (SD).

**Table 1: Summary of data transformation**

Level	Data format	SPD	RD	TPD	STPD	FMF	PDF
1	SPD	-	-	-	-	-	-
2	RD	Compute the average	-	-	-	-	-
3	TPD	Use the likely value	Use the lower & upper values	-	-	-	-
4	STPD	Use the likely value	Use expanded bound	Use the expanded bounds & likely value	-	-	-
5	<b>FD</b>	-	-	-	-	-	-
5a1	RFMF	Use defuzzified value of FMF	Use the lowest & highest values of the FMF	Use the lowest, highest, & defuzzified value of FMF	Use the expanded bounds, defuzzified value, & confirm the 25% condition	-	Transform using prob. Pos. consistency principle
5b1	TFMF	As above	As above	As above	As above	-	As above
5c1	TrpFMF	As above	As above	As above	As above	-	As above
5d1	GFMF	As above	As above	As above	As above	-	As above
5	<b>PDF</b>	-	-	-	-	-	-
5a2	OPDF	Use the modal value of the PDF	Use the lowest & highest values of the PDF	Use the range & the modal value	Use the range, modal value, & confirm the 25% condition	Transform PDF into FMF using pro./pos. consistency principle	-
5b2	SPDF	-	-	-	-	-	-
5b21	UPDF	Use the average value of lower & upper bounds	Use adjusted bounds	-	-	Transform PDF into FMF using pro./pos. consistency principle	-
5b22	TPDF	Use the likely value	Use adjusted bounds	Use adjusted bounds & the likely value	Use lower and upper bounds, likely value, & confirm the 25% condition	Transform PDF into FMF using pro./pos. consistency principle	-
5b23	TrpPDF	Use the mean value	Use range of likely values	Use lower & upper bound and the average of range of likely values	Use lower and upper bounds, average of the likely values, & confirm the 25% condition.	Transform PDF into FMF using pro./pos. consistency principle	-
6	<b>SD</b>	-	-	-	-	-	-
6a	RSD	Compute the average.	Use the range.	Use the range and modal value	Use the expanded range, mean value & confirm the 25% condition	Transform PDF into FMF using pro./pos. consistency principle.	Convert data to frequency distribution & fit-in a PDF
6b	NRSd	Compute the average	Use the range	Use the range & modal value	-	Develop a FMF	-



FD has four variants or formats: Rectangular Fuzzy Membership Function (RFMF), Triangular FMF (TFMF), Trapezoidal FMF (TrpFMF), and Gaussian FMF (GFMF). PDF has two main variants, i.e. Objective PDF (OPDF) derived from historical data and Subjective PDF (SPDF). The SPDF has three sub-variants or formats which are: Uniform PDF (UPDF), Triangular PDF (TPDF), and Trapezoidal PDF (TrpPDF). Statistical Data (SD) has Random SD (RSD) and Non-random SD (NRSD) as its variants.

The direction of transformation is chosen such that no additional information is needed during the conversion process. On this basis, six levels of data were observed. The lowest level is the SPD as it cannot be transformed to any other level, followed by RD, TPD, STPD at the 2nd 3rd and 4th levels. Both FD and PDF are at the same 5th level as each data type can be transformed to the other. Statistical Data (SD) is at the 6th and highest level as it can be transformed to five lower levels.

Table 2 is a ranking of the data formats based on the number of transforms they can generate. From the table, RSD is ranked 1st as it generates six number transforms. In contrast, NRSD also a variant of SD ranked 9th as it can generate only four transforms. PDFs and FMFs have the same ranking (2nd) as they can each be transformed to five other formats. They are a special class of data as each data type can be transformed to the other. Unlike the other PDFs, UPDF can only provide three transforms and is ranked 10th alongside STPD.

**Table 2: Transformability ranking of data formats**

Data format	Abbreviation	Number of transforms	Ranking
Random statistical data	RSD	6	1
Objective probability density function	OPDF	5	2
Trapezoidal probability density function	TrpPDF	5	2
Triangular probability density function	TPDF	5	2
Rectangular fuzzy membership function	RFMF	5	2
Triangular fuzzy membership function	TFMF	5	2
Trapezoidal fuzzy membership function	TrpFMF	5	2
Gaussian fuzzy membership function	GFMF	5	2
Non-random statistical data	NRSD	4	9
Stochastic three-point data	STPD	3	10
Uniform probability density function	UPDF	3	10
Three-point data	TPD	2	12
Interval data	RD	1	13
Single Point data	SPD	0	14

The implication of the ranking is that, data formats with the highest ranking are more flexible, so should be preferred since they provide a wider option for transformation. Thus, SPD should be the least desired while RSD should be the most preferred.

## CONCLUSION

A conceptual framework for data characterisation and model selection was proposed. Based on the framework, seven scenarios engendered by different mixes of data attributes, generates a mapping of seven quantitative data types onto six modelling approaches. For each scenario, possible logical decisions in terms of the most befitting data type or format and model or modelling technique to deploy were suggested. Two of the seven scenarios identified are not common in WLC practices. The first involves incomplete data where data augmentation is suggested as a first option prior to describing data as unavailable. The second scenario involves the resolution of data variability into epistemic and aleatory uncertainty which reduces the likelihood of underestimate.

To compliment the model selection process, data transformation procedures were articulated, based upon which transformability ranking for fourteen varieties of data formats was determined. Based on the ranking, the most important data formats are random statistical data, probability density functions and fuzzy membership functions. Generally, the framework provides a guide to built-environment cost professionals for; selecting a suitable data format for WLC in different situations; converting WLC data into different types and subtypes which improves data usability and share ability. It also provides a mapping of the data format to an appropriate model which helps in minimizing model-data mismatch.

Finally, this paper has cleared the ground for the development of transformation algorithms and the design and implementation of a database that would facilitate WLC data storage and retrieval in a variety of formats.

## REFERENCES

- Al-Hajj, R., Pollock, M., Aoud, G., Sun, M., & Bakis, N., (2001). On the requirement for effective Whole Life Costing in an Integrated Environment. Proceedings of the Construction and Building Research Conference of the RICS Research Foundation (COBRA '2001), 3rd to 6th September, Glasgow Caledonian University.
- Anderson, D.R., Sweeney, D.J., & Williams, T.A., (2004). Quantitative methods for business. 9th ed. Ohio, USA: South-western.
- Ashworth, A., & Perera, S., (2016). Cost studies of buildings. 6th ed, London: Routledge.
- Aughenbaugh, J. M., & Paredis, C. J. M. (2006). The value of using imprecise probabilities in engineering design. *Journal of Mechanical Design*. 128(4), 969–979.
- Boussabaine, A., & Kirkham, R. (2004). *Whole Life Cycle Costing: Risk and Risk Responses*. 1st ed., Oxford: Blackwell Publishing Ltd.
- Bowen, P. A., Walvaardt, J. S., & Taylor, R. G. (1987). Cost modelling: A process modelling approach. In: P.S. Brandon, ed. *Building cost modelling and computers*. London: E & FN Spon.
- Bruns, M. Paredis, C. J. J., & Ferson, S., (2006). Computational methods for decision making based on imprecise information. Proceedings of the NFS Workshop on Reliable Engineering Computing: Modelling Errors and Uncertainty in Engineering Computations, Savannah, Georgia, pp. 1761–1769,

- Dell'Isola, A. J., & Kirk, S. J. (2003). *Life Cycle Costing for Facilities*, 1st Ed, Construction publishers and consultants, US
- Dell'Isola, A.J., & Kirk, S. J. (1981). *Life Cycle Costing for Design Professionals*, 1st ed., New York: McGraw – Hill Inc.
- Deng, Q., & Ji, S. (2018). A Review of Design Science Research in Information Systems: Concept, Process, Outcome, and Evaluation. *Pacific Asia Journal of the Association for Information Systems*. 10(1), 1-36.
- El-Haram, M. A., Malcolm, R., Horner, W., & Marenjak, S. (2007). Accuracy of estimating whole life cost: In W., Huges, ed. *Proceedings of the inaugural construction management and economics "Past Present and Future 'conference CMER5, 16th to 18th July, University of Reading, UK, pp 527-534.*
- Ellingham, I., & Fawcett, W. (2006). *New Generation Whole-Life Costing: Property and construction decision-making under uncertainty*, 1st ed., UK: Taylor and Francis.
- Fellows, R., & Liu, A, (2003). *Research Methods for Construction*. 2nd ed, UK: Blackwell Science Ltd.
- Flanagan, R., & Jewell, C. (2005). *Whole Life Appraisal for Construction*. 1st ed. Oxford: Blackwell Publishing Ltd.
- Flanagan, R., Kendell, A., Norman, G., & Robinson, G. D. (1987). Life cycle costing and risk management. *Construction Management and Economics*, 5(4), 53- 71.
- Galway, L. A. (2007). *Subjective Probability Distribution Elicitation in Cost Risk Analysis*. USA: RAND Corporation.
- Gregg, D. G., Kulkarni, U. R., & Vinzé, A. S., (2001). Understanding the Philosophical Underpinnings of Software Engineering Research in Information Systems. *Information Systems Frontiers*, 3(2), 169–183.
- Higham, A. P., Fortune, C. J., & James, H. (2015). Life-cycle costing: Evaluating its use in UK practice. *Structural Survey*. 33(1), 73-87
- Hoar, D. W., (2007). An Overview of life-cycle costing techniques. *Journal of Property Management, EmeraldBackfiles*, 6(2), 92-98.
- Huijbregts, M. A. (1998). Application of uncertainty and variability in LCA. *International Journal of Life Cycle Assessment*. 3, 273–280.
- Huijbregts, M. A. J., Gilijamse, W., Ragas, A. M. J., & Reijnders, L. (2003). Evaluating uncertainty in environmental life-cycle assessment. A case study comparing two insulation options for a Dutch one-family dwelling. *Environmental Science and Technology*. 37(11), 2600–2608.
- Ilg, P. Scope, C., Muench, S., & Guenther, E. (2017). Uncertainty in life cycle costing for long-range infrastructure. Part I: levelling the playing field to address uncertainties. *International Journal Life Cycle Assessment*. 22, 277-292.
- Kim, G., An, S., & Kang, K. (2004). Comparison of construction cost estimating models based on regression analysis, neural networks, and case-based reasoning. *Building and Environment*. 39, 1235 – 1242.
- Kirkham, R. (2015). *Ferry and Brandon's cost planning of buildings*. 9th ed, Chichester: John Wiley & Sons Ltd.
- Kishk, M., & Al-Hajj, A. (2000). A fuzzy model and algorithm to handle subjectivity in life cycle costing bases decision-making. *Journal of Financial Management of Construction and Property*. 5(1&2), 93-104.

- Kishk, M., (2002). Towards effective consideration of non-financial factors in the design and management of construction assets. *Journal of Financial Management of Property and Construction*. 7(3), 163-173.
- Kishk, M., Al-Hajj, A., & Pollock, R. (2002). An innovative integrated approach to whole life costing. *Journal of Financial Management of Property and Construction*. 7(1), 31-40.
- Kishk, M., Al-Hajj, A., Pollock, R., Aoud, G., Bakis, N., & Sun, M. (2003). *Whole Life Costing in Construction (A state of the Art Review)*. London: RICS foundation.
- Norman, G. (2007). Life Cycle Costing: Briefing. *Journal of Property Management, EmeraldBackfiles*. 8(4), 344-356.
- Oberkampf, W. L., & Helton, C.J. (2001). Mathematical Representation of Uncertainty, *Proceedings of the 19th American Institute of Aeronautics & Astronautics Applied Aerodynamics Conference, 6th -19th April, Seattle, WA*.
- Opawole, A., Babatunde, S. O., Kajimo-Shakantu, K., & Ateji, O. A. (2020). Analysis of barriers to the application of life cycle costing in building projects in developing countries: A case of Nigeria. *Smart and Sustainable Built Environment*. 9(4), 503-521.
- Ross, T. J. (2004). *Fuzzy Logic with Engineering Applications*, 2nd ed. England: John Wiley and Sons Ltd.
- Saridaki, M., Psarra, M., & Haugbølle, H. (2019). Implementing life-cycle costing: data integration between design models and cost calculations. *Journal of Information Technology in Construction (ITcon)*. 24, 14-32.
- Scope, C., Ilg, P., Muench, S., & Guenther, E. (2016). Uncertainty in life cycle costing for long-range infrastructure. Part II: guidance and suitability of applied methods to address uncertainty, *International Journal of Life Cycle Assessment*, 21, 1170-1184.
- Seeley, I. H. (1998). *Building Economics*. 4th ed, UK: Macmillan Press Ltd.
- Skitmore, M., & Marston, V. (1999). *Cost Modelling*. London: E & FN SPON.
- Spiegel, M.R., Stephens, L. R., (1999). *Statistics*. 4th ed. USA: McGraw-Hill Inc.
- Stephen, L. & Berenson, K. (2005). *Statistics for managers*, 4th Ed., UK: Pearsons Prenticehall.
- Tran, T., Pham, T., Carneiro, G., Palmer, L. & Reid, I., (2017). A Bayesian Data Augmentation Approach for Learning Deep Models. *Proceedings of the 31st Conference on Neural Information Processing Systems (NIPS 2017)*, 4th to 7th December, Long Beach, CA, USA.
- VanDyk D. A., & Meng, X., (2001). The Art of Data Augmentation. *Journal of computational and Graphical Statistics*. 10(1), 1-50.
- Wang, N., Chang, Y., & El-Sheikh, A. A. (2012). Monte Carlo simulation approach to life cycle cost management, *Structure and Infrastructure Engineering*. 8(8) 739-746.
- Xu, Y., Elgh, F., Erkoyuncu, J.A., Bankole, O. Goh, Y., Cheung, W. M., Baguley, P., et al. (2012). Cost Engineering for manufacturing: Current and future research. *International Journal of Computer Integrated Manufacturing*. 25(4-5), 300-314.
- Zheng, Q., Yang, M., Tian, X., Jiang, N., & Wang, D. (2020). A full stage data augmentation method in deep convolutional neural network for natural image classification. *Discrete Dynamics in Nature and Society*. 2020, 1-12.
- Zimmermann, H. J. (2001). *Fuzzy set theory and it's application*. 4th ed. Massachusetts, USA : Kluwer Academic Publishers.



---

# CONSTRUCTION IN DEVELOPING COUNTRIES: NEED FOR NEW CONCEPTS AND THEORISING OF CONTEXTUAL SPECIFICITIES TO THE GLOBAL CORPUS OF KNOWLEDGE

George Ofori<sup>1</sup>

*School of the Built Environment and Architecture, London South Bank University, UK*

Studies on construction industries in developing countries have resulted in a distinct field of knowledge. The aim of this study is to contribute to the debate on whether new perspectives and concepts of the body of knowledge of construction in developing countries must be found because of the requirements and contexts of developing countries. The study is based on a review of the literature on the body of knowledge of construction in developing countries. It is found that developing countries need high volumes of constructed items, but the capacity of the construction industries in these countries, and their performance require major improvement. Research should contribute to improving the industry's capability and performance. However, progress in the development of the body of construction in developing countries has stalled. Subjects on which further research is most needed are outlined. It is concluded that the construction industry in developing countries requires more sophisticated approaches and analyses than their industrialised countries counterparts. It is necessary to reconsider construction in developing countries to enable research on the subject to contribute to practice in improving the performance of the industries in those countries.

Keywords: body of knowledge, capacity and capability, construction in developing countries, research new perspectives

## INTRODUCTION

### Research objectives and method

At the ARCOM 2018 Conference, a panel discussed "Alternative Frames of Thinking on Construction in Developing Countries". Ofori (2019) followed up on this with a paper. This study considers the arguments further.

The objectives of this study are to:

- Consider why it is essential to improve the capacity, capability and performance of the construction industries of developing countries

---

<sup>1</sup> oforig3@lsbu.ac.uk

- Discuss the history and current state of the body of knowledge on construction in developing countries
- Consider ways in which the existing body of knowledge on construction in developing countries should be amended to reflect the context of developing countries.

The paper is based on a review of the literature on the body of knowledge on construction industries in developing countries.

## **IMPORTANCE OF IMPROVING CONSTRUCTION IN DEVELOPING COUNTRIES**

### **What is a developing country?**

The common definition of a “developing country” is based on gross national income (GNI) per capita. World Bank classifies countries with GNI per capita of US\$1025 and below in July 2019 as Low Income; Lower-middle Income countries fall between US\$1026 and US\$3995; Upper-middle Income countries are between US\$3996 and US\$12,375; and High Income countries have GNI per capita of US\$12,375 and above (World Bank Data Team, 2019). “Low income” and “Lower middle income” nations are “developing countries”. Many authors do not agree with this classification (see Meikle, 2019). It is worth noting that the classification is undertaken every year, and countries can be reclassified under the categories. Also, developing countries differ among themselves in many regards, including their prospects for development (Han and Ofori, 2001).

Where construction is concerned, Ofori (2012b) noted differences between developed and developing countries by considering: features of the construction industry, projects and products; performance of the industries; and driving forces of construction including: environmental issues and climate change; safety and health; poverty alleviation; globalization; technology development and innovation; information and communications technology (ICT); quality and productivity; and disaster prevention and reconstruction.

### **Improving construction: the need and the task**

The capacity and capability of the construction industries in developing countries should be enhanced to enable them to provide the economic and social infrastructure for the countries’ long-term development. UN (2019) notes that poverty, hunger and disease are concentrated in the poorest and most vulnerable countries. The Post-2015 Development Agenda for addressing this is based on attaining 17 Sustainable Development Goals (SDGs) by 2030. The Economist Intelligence Unit (2017) notes that infrastructure is at the heart of efforts to meet the SDGs. World Bank (2017c) estimates that in Sub-Saharan Africa, closing the infrastructure quantity and quality gap relative to the world’s best performers could raise GDP growth per capita by 2.6 percent per year. The latest SDG Report (UN, 2019) indicates that the rate of extreme poverty fell from 36 percent in 1990 to 16 percent in 2010 and to 10 percent in 2015 (over one billion people rose from poverty over 25 years). However, the pace of change is declining; on current trends, 6 percent of the global population will be living in extreme poverty in 2030. Some

736 million people lived on less than US\$1.90 a day in 2015 (413 million were in sub-Saharan Africa).

Since 2008, over half of the world's population has lived in urban areas; this is expected to be 60 percent by 2030 (UN, 2018). Cities can be made inclusive, sustainable and dynamic hubs of economic activity and innovation, but face problems in managing air pollution, unplanned land use, inadequate housing and infrastructure, growing slum population, lack of basic services, urban sprawl, and vulnerability to disasters. UN (2018) noted that between 2000 and 2014, the slum population rose from 807 million to 883 million. UN Task Team on Habitat III (2017) notes that, in the next 30 years, nearly 2.5 billion people will be added to the world urban population. New cities and planned extensions will have to be built.

Thus, the developing countries have huge volumes of construction needs. However, the construction industries in developing countries lack the capacity and capability to meet the infrastructure demands of these countries (Ofori, 2007). Their performance falls short of what clients and beneficiaries desire, and that of their industrialised country counterparts; they are unable to contribute towards improving standards of living, or creating a conducive environment for investment (Rwelamila and Ogunlana, 2015). Thus, research should help improve the performance of the industries.

### **Nature of construction industries in developing countries**

What is the current nature of the industries? Mir et al. (2007) found that challenges facing construction industries in developing countries include: insufficient education and training; absence of government commitment; lack of long-term vision and planning for the industry; fluctuations in workload; ineffective budgeting; defective contract documents; corrupt procedures; payment-related delays; problems of bonding and insurance; lack of adequate financial resources; foreign exchange constraints; non-availability of equipment and spare parts; and poor information.

Are new approaches in construction knowledge, techniques, practices and procedures needed to enable construction industries in developing countries address the infrastructure needs and challenges? The body of knowledge on the construction industry in developing countries should be understood in order to explore what new perspectives need to be considered to enable it to make an effective contribution towards improving the performance of the industries in those countries.

## **CONSTRUCTION IN DEVELOPING COUNTRIES**

### **History of studies on construction in developing countries**

Arguably the first significant work on the construction industries in developing countries is the report by the United Nations Expert Group on Housing (Department of Economic and Social Affairs, 1962). That group concluded that the level and quality of housing, sanitation and other infrastructure in the developing countries was poor. It argued that, among other actions, efforts should be made to improve the capacity and capability of the construction industries if these conditions were to be addressed. Abrams (1964) (a member of the expert group)

reached made similar recommendations. Turin (1969, 1973) investigated the role of construction in the economy and in national development; and made industry development proposals. Major reviews of the field by the early 1980s were presented by Kafandaris (1980) and Drewer (1980).

The first books on Construction in Developing Countries were: World Bank (1984) and Wells (1986). Ministry of Works (1977) was a major report on Tanzania's construction industry by a group of international experts in an extensive, three-month country study. Multi-lateral organisations such as the International Labour Office (ILO) (Edmonds and Miles, 1984), United Nations Centre for Human Settlements (1991) and United Nations Industrial Development Organisation (UNIDO) (1969) commissioned studies on construction in developing countries.

The main areas of the subject of construction in developing countries which have been studied can be outlined as (Ofori, 2015, 2019):

- Materials Development – research and development on local materials; development of manufacturing of materials; promotion of their adoption by addressing obstacles to the take-up; policy directions such as incentives and training of tradespersons (Syagga, 1993; UNIDO, 2008)
- Human Resource Development – skills gap analyses; education and training with focus on trades; development of courses deemed relevant to developing countries; continuing professional development (ILO, 2001; Loganathan et al., 2017)
- Technology Development – development of 'appropriate' and labour-based technologies; technology transfer; mechanization; government policies; manufacturing of equipment; ICT applications (UNCHS, 1992; CIDB, 2015)
- Corporate Development – contractor development; joint ventures; registration and accreditation; development of consultants (UNCHS, 1996)
- Institution Building – administrative framework; development of professional institutions and trade associations; formation of industry development agencies (CIDB, 2015; Ofori-Kuragu et al., 2016)
- Regulations, Procedures and Practices (Ofori, 1993; Windapo and Rotimi, 2012).

Giang and Low (2010) and Ofori (2015) present good recent reviews of the subject. It should be noted that there are also wrong characterisations, as some of the work is wrongly attributed. Ofori (1993, 1994) considered progress in research on construction in developing countries, and implementation of its results, and suggested that the field was at a crossroads. For example, the changes in the role of construction in the economy over time, found by Turin (1969) which Strassman (1970) termed the "middle-income country bulge", has been called "Bon Curves" by many authors (Ruddock and Lopes, 2006) (after Bon (1992)).

"Construction in Developing Countries" is a module in some universities such as University College London, UK and University of Reading, UK. The field has a global research group, CIB W107 on Construction in Developing Countries (which was established as Task Group 29 in 1998). The Journal of Construction in Developing



Countries (first published in 2006), is its main publishing outlet. The literature on the field provides the framework for industry development policies such as industry development strategies for Sri Lanka (National Advisory Council on Construction, 2014) and Ethiopia (Ministry of Urban Development and Construction, 2012). Recent important works include the Construction Industry Capacity Framework, a diagnostic tool for analysing any construction industry (Arup, 2018); and the study of the industry in India (Loganathan et al., 2017). Thus, construction in developing countries can be considered to be an established subject with a body of knowledge.

### **Current state of the field**

The body of knowledge on construction in developing countries has failed to grow in the last decade; there has been no significant breakthroughs. Ofori (2012a, 2012b) on new aspects of the subject, and on considering contemporary issues in construction from the perspective of developing countries respectively, addressed the lull. It is critical to grow and improve the body of knowledge because the countries' needs are huge and growing, as discussed above. Thus, it is necessary to provide the countries with guidance to prepare their industries for their future challenges.

It could be argued that the construction industry is the same everywhere, and the same principles should apply universally; thus, there is no need to focus on any particular segment. Others would suggest it is necessary to build new knowledge to suit the special circumstances of developing countries. Ofori (2012b) analyzes differences between industrialized and developing countries and their construction industries and introduces the expression, "developing country exceptionalism". He suggests that, given these differences, the body of knowledge on construction in developing countries should be modified to be most applicable in developing countries.

Various authors have suggested topics for further research on construction in developing countries. For example, CIB W107 suggests these topics in its research roadmap (Rwelamila and Ogunlana, 2015): Construction in a Model of Development; Sustainability in Housing; Human Resource Development; Modernising the Traditional; Gender Equity; Financing and Procurement; Governance and Management; Information Technology Applications on Projects; and Industry Development. Ofori (2016) suggested that researchers should consider the possibility of leapfrogging.

## **SOME PROPOSALS FOR DEVELOPING NEW CONCEPTS**

In this section, how the body of knowledge on construction in developing countries can be reconsidered to make it more relevant to those countries is discussed.

### **Project management in context of developing countries**

The areas of knowledge and project management processes and activities under them as in the Project Management Institute (PMI) Body of Knowledge (PMI, 2017) are: Project Integration Management; Project Scope Management; Project Schedule Management; Project Cost Management; Project Quality Management; Project Resource Management; Project Communications Management; Project Risk Management; Project Procurement Management; and Project Stakeholder

Management. In the developing countries, construction projects involve many more tasks than those in these ten areas. Thus, there is a need for a different conceptualisation of project management in the context of developing countries. Stuckenbruck and Zomorrodian (1987) note that in developing countries, project management should only be applied when certain technical, political, and environmental conditions are met, and when it is incorporated into an indigenous framework based on local values, beliefs and behavioural patterns.

A possible new project management area of knowledge is "Management of the Business Environment" which covers the context of the project and participating organisations. This includes the regulatory and administrative framework, procedures and practices in the industry, and the infrastructure. Rodinelli (1976) noted that political, economic, operational, social and physical difficulties either delay projects or cause them to fail. Similarly, Watermeyer (2018) describes the underlying context of projects which includes cultural, ethical, societal, political, economic and physical risks in the region where the built item is required. Another new area of knowledge is "Operating and Facilities Management". Effective operation of the built item is a determinant of project success. Strategic facilities management where inputs from operation of buildings help to improve the design of new buildings is useful in developing countries (Jensen et al., 2019). Preparation of as-built documentation or three-dimensional models to facilitate the management of the facility should be given attention (Chong et al., 2019); as should the building of capacity for maintaining the built item (World Bank, 1984; Morgan et al., 2017).

### **Parameters for assessing project performance**

Project performance parameters need to be framed to suit the context of developing countries. New parameters (to supplement the usual cost, time, quality, health and safety and environmental performance) include: affordability and life-cycle costing; and employment generation (see Ofori, 2012a, 2019). These are now discussed.

"Affordable housing" is topical in most countries (see, Senate Economics References Committee (2015) on Australia; and Mutero (2018) on African countries), but critical in developing nations where the housing shortage is greatest. UN (2017) considers adequate and affordable housing a component of the right to an adequate standard of living. Effective consideration of affordability over the long-term to cover the life-cycle ownership of built items would enable countries to invest in projects which are appropriate in their contexts.

In developing countries, it is pertinent to derive benefit from the employment generation potential of construction. This should be addressed in the technological choice, procurement approach and terms of contract (ILO, 2001; Mella and Savage, 2018). In rural areas, work opportunities on projects can be used to enhance income (Watermeyer, 2018). This requires a new definition of, and modelling for, construction productivity in developing countries which involves consideration of: job creation and decent jobs; and a balance with time, cost, quality and health and safety.

Other objectives of projects in developing countries include (Watermeyer, 2018): strengthening of indigenous building materials and methods; and job

opportunities for small and medium firms. Industry policies, project evaluation models, and project management systems should be formulated to enable the wider range of objectives and performance parameters to be attained.

### **Safeguarding in construction in developing countries**

In most countries, the social image of the construction industry is poor (ILO, 2001; PwC, 2014; Morrell, 2015) owing to the physical demands involved; a high rate of accidents and fatalities; low pay; a reputation for corruption; and lack of trust from the public. Many programmes have been introduced in different countries to change the picture. For example, in the UK, key performance indices track performance at industry level on aspects relating to 'people' including (Staff Turnover, Sickness Absence, Safety – Industry Working Hours, Qualifications and Skills, Training, Investors in People, and Staff Loss) (The KPI Team, 2018). The Considerate Constructors Scheme (undated) commits registered sites, companies and suppliers to care about appearance, respect the community, protect the environment, secure everyone's safety, and value their workforce. Similar schemes can be considered in developing countries.

In welfare and safeguarding, focus has been on the construction industry's workers. However, construction projects have impacts on people living in their environs. Moreover, the project's workers might settle temporarily in the community, with possible unintended social consequences. Thus, consideration of welfare could be broadened. The World Bank, (2017a) and other lending institutions have social safeguarding policies for projects they fund. For example, in 2015, the Bank suspended a highway project in Uganda due to contractual breaches related to workers' issues, social and environmental concerns, and allegations of sexual misconduct and abuse by contractors, and only lifted it in 2017 after working with the government to support the affected communities and address social problems (World Bank, 2017b). There is a case for establishing the concept of Social Safeguarding and Benefit in Construction. Researchers could build on the existing policies of the lending institutions (World Bank, 2017a) to devise the concept.

### **Culture as a key in project management in developing countries**

Many authors argue that the notion of the project is a Western one; and project management is culturally bound (Koster, 2010). Thus, it is necessary to make changes to the way project management is practised if it is to work in developing countries (Russell-Hodge and Hunnam, 1998; Rwelamila, 2012). Lizzarralde et al. (2013) found differences in how power and authority are exercised, and in the roles assumed by stakeholders on projects in developing countries. They noted that such differences are often considered to be problems to be 'fixed' but should be understood as project governance mechanisms of adaptation to different environmental conditions. Rodinelli (1976) noted that: "Cultural, political and social traditions, in many cases, inhibit the use of American or European project management procedures. Even the most efficient multinational corporations undertaking new ventures in Third World countries find unanticipated crises arise continuously to obstruct the smooth execution of major projects". Al-Sedairy and Rutland (1994) and Youker (2007) highlighted the unique nature of project management in developing countries. Rwelamila et al. (1999) suggested that poor performance on construction projects in Africa could be explained by a failure to apply the 'ubuntu' concept in the management approach.

Culture should be more fully applied in planning, design and project management in developing countries. Reviews of many projects and national development plans show that a major cause of poor project outcomes is failure to involve the community effectively (Choghuill, 1996). Participation of the community and the hierarchical traditional systems could be optimised with appropriate project strategies.

### **Materials, technologies and skills fitting the context of developing countries**

Developing countries should seek to apply the best appropriate technology and practice and in their contexts and resource circumstances (Ofori, 2016). In some cases, it will involve modifying an existing technology, practice or procedure to suit their contexts. In others, it will mean developing new approaches peculiar to the countries' needs and circumstances. Thus, technologies and practices considered to be only applicable in "more sophisticated" industries, including advanced digital applications, new materials, and off-site construction, should be considered. For example, off-site applications are not new in developing countries; Richard (2004) has long proposed their use to address housing problems. The potential of leapfrogging should be pursued in research and development on technology and its application.

Local materials, techniques and their production and application systems which have been disregarded or are not popular because they are considered to be unsuitable for the sophisticated should be revisited (UNIDO, 2008). Sojkowski (2015) noted that "western material and construction techniques are seen as correct, modern, permanent, and for the affluent, the vernacular is viewed as substandard, outdated, temporary, or for the poor". The modernised traditional technologies and materials which have been developed, such as, in Ghana, the modified Atakpame building (with mud walls reinforced with a wooden frame) and landcrete blocks (with a low cement content) are of merit, given the current focus on sustainability. Incentives for developing such items, and initiatives for their application through demonstration effects in their usage could be studied. The labour-intensive road construction programme of the ILO (Tembo and Blokhuis, 2004) which developed techniques, equipment, tools, skills and firms, merits further research and development to upgrade and upscale it.

There is potential to combine the traditional with the local. For example, in human resource development, construction trades training can be upscaled by combining traditional apprenticeship and formal courses as in the Ghana Skills Development Initiative (GFA Consulting 2019). To succeed, it will be necessary to introduce modularisation, recognition of prior experience, accreditation and progression of trained tradespersons to high qualification programmes.

### **New ideas for broad industry development**

Construction industry development should be sharpened in developing countries. In the UK, not much has been achieved from the many industry reviews (Bailey, 2018). Developing countries should undertake industry reviews and develop ways forward. Some principles include: strategic prioritisation of initiatives, starting with those with no prerequisites and with synergies; joined-up thinking; and sharing of good practice and cautionary information from elsewhere. The considerations

include: the role of construction in national development plans and policies; preventing and addressing fragmentation of the industry to avoid stratification and adversarialism; institution building and synergisation with recognition of local systems; and the role of government and merits of state leadership.

## CONCLUSION

It is important to consider the context of the developing countries including the legal structures, institutions, infrastructure and culture and their influence on practices and procedures in undertaking research on, as well as in applying, the body of knowledge on construction in those countries. This will enable further principles, tools and techniques for these countries to emerge. Considering the context and needs of the developing countries, it is evident that the construction industry requires a richer, more complex knowledge base than what pertains in the industrialised countries. It is also pertinent to note that this special field of construction in developing countries has the potential to contribute to the broader Construction Management and Economics body of knowledge. Finally, it should be noted that specific effort will have to be invested to attain the intentions outlined in this paper. The leadership of CIB W107, of leading researchers on the area and of journal editors and administrators of the leading industry development agencies who are persuaded of the need for this additional element will be useful in these regards.

## REFERENCES

- Abrams, C. (1964) *Housing in the Modern World*. Faber and Faber, London.
- Al-Sedairy, S.T. and Rutland, P. (1994) Project management as a way forward in a developing country. In D.I. Cleland and R. Gareis (eds) *Global Project Management Handbook*. McGraw Hill, New York, pp. 5-3 to 5-23.
- ARCOM (2019) Reflection by Professor George Ofori, London South Bank University. ARCOM Newsletter, Vol. 36, No. 1, p. 6.
- Arup (2018) *Construction Industry Capacity Framework*. Department for International Development, London.
- Bon, R. (1992) The future of international construction: secular patterns of growth and decline. *Habitat International*, 16(3), 119-128.
- Choguill, M.B.G. (1996) A ladder of community participation for underdeveloped countries. *Habitat International*, 20(3): 431-444.
- Chong, A., Mohammed, A., Abdullah, M. and Rahman, M. (2019) Maintenance prioritization – a review on factors and methods. *Journal of Facilities Management*, Vol. 17 No. 1, pp. 18-39. <https://doi.org/10.1108/JFM-11-2017-0058>
- Considerate Constructors Scheme (undated) Considerate Constructors Scheme Company Registration. Ware, Herts, [https://www.ccscheme.org.uk/wp-content/uploads/2018/12/CompanyRegistrationBrochure\\_v2.0.pdf](https://www.ccscheme.org.uk/wp-content/uploads/2018/12/CompanyRegistrationBrochure_v2.0.pdf)
- Construction Industry Development Board (CIDB) (2015) *Construction Industry Transformation Programme 2015–2020: Driving construction excellence together*. Kuala Lumpur.

- Debrah, Y.A. and Ofori, G. (2005) Human resource development of professionals in an emerging economy: The case of Tanzanian construction industry. *International Journal of Human Resource Management*, 17(3): 440–463.
- Department of Economic and Social Affairs (1962) Report of the Ad Hoc Group of Experts on Housing and Urban Development. New York: United Nations.
- Drewer, S. (1980) Construction and development: A new perspective. *Habitat International*, Vol. 5, Issues 3-4, pp. 395-428.
- Edmonds, G.A. and Miles, D.W.J. (1984) *Foundations for Change: Aspects of the construction industry in developing countries*. Intermediate Technology Publications Ltd., London. <https://doi.org/10.3362/9781780442242.000>
- Fateh, M.A.M. and Mohammad, M.F. (2017) Industrialized building system (IBS) provision in local and international standard form of contracts. *Journal of Construction in Developing Countries*, 22(2): 67–80. <https://doi.org/10.21315/jcdc2017.22.2.5>
- GFA Consulting Group (2019) Ghana Skills Development Initiative (GSDI III), [https://www.gfa-group.de/projects/Ghana\\_Skills\\_Development\\_Initiative\\_GSDI\\_III\\_3884439](https://www.gfa-group.de/projects/Ghana_Skills_Development_Initiative_GSDI_III_3884439)
- Giang, D.T.H. and Low, S.P. (2010) Role of construction in economic development: Review of key concepts in the past 40 years. *Habitat International*, Vol. 35, Issue 1, pp. 118-125, <https://doi.org/10.1016/j.habitatint.2010.06.003>
- Han, S.S. and Ofori, G. (2001) Construction industry in China's regional economy, 1990–1998. *Construction Management and Economics*, 19(2): 189-205.
- International Labour Organisation (2001) *The Construction Industry in the Twenty-first Century: Its image, Employment Prospects and Skill Requirements*. Geneva.
- Jensen, P., Rasmussen, H. and Chatzilazarou, S. (2019) Knowledge transfer between building operation and building projects. *Journal of Facilities Management*, Vol. 17 No. 2, pp. 208-219, <https://doi.org/10.1108/JFM-05-2018-0030>
- Kafandaris, S. (1980) The building industry in the context of development. *Habitat International*, Vol. 5, Issues 3-4, pp. 289-322.
- Koster, K. (2010) *International Project Management*. Sage, London.
- Lizzaralde, G., Tomiyoshi, S., Bourgault, M., Malo, J. and Cardosi, G. (2013) Understanding differences in construction project governance between developed and developing countries. *Construction Management and Economics*, Vol. 31, No. 7, 711-730.
- Loganathan, S., Srinath, P., Mohan Kumaraswamy, M., Kalidindi, S. and Varghese, K. (2017) Identifying and addressing critical issues in the Indian construction industry: perspectives of large building construction clients. *Journal of Construction in Developing Countries*, Vol., 22, pp. 121-144. <https://doi.org/10.21315/jcdc2017.22.suppl1.7>
- Lopes, J. (2012) Construction in the economy and its role in socio-economic development. In G. Ofori (ed.) *New Perspectives on Construction in Developing Countries*. Abingdon, pp. 40–71.
- Meikle, J. (2019) A response to George Ofori's special note. *Journal of Construction in Developing Countries*, 24 (2), 207-208, <https://doi.org/10.21315/jcdc2019.24.1.10>
- Mella, A. and Savage, M. (2018) *Construction Sector Employment in Low Income Countries*. Department for International Development, London.
- Ministry of Urban Development and Construction (2012) *Construction Industry Policy*. Addis Ababa.

- Ministry of Works (1977) National Construction Industry Study: Final report. Dar es Salaam.
- Mir, A. H., Tanvir, M. and Durrani, A.Z. (2007) Development of Construction Industry – A literature review, Pakistan Infrastructure Implementation Capacity Assessment, Report No. 43185. World Bank, Washington, D.C.
- Morgan G., Ceppi P., Crosskey S., and O'Regan, N. (2019) The Importance of Infrastructure for Landlocked Developing Countries. UNOPS, Copenhagen.
- Morrell, P. (2015) Collaboration for Change. The Edge, London.
- Mutero, J. (2018) Taxation and Affordable Housing in Africa. Centre for Affordable Housing in Africa, Johannesburg, [http://housingfinanceafrica.org/app/uploads/Taxation-and-Affordable-Housing-in-Africa\\_final-edits-ltso.pdf](http://housingfinanceafrica.org/app/uploads/Taxation-and-Affordable-Housing-in-Africa_final-edits-ltso.pdf)
- National Advisory Council on Construction (2014) National Policy on Construction. Ministry of Housing and Construction, Colombo.
- Ofori, G. (1993) Research on construction industry development at the crossroads. *Construction Management and Economics*, 11:3, 175-185, DOI: 10.1080/01446199300000017
- Ofori, G. (1994) Practice of construction industry development at the crossroads. *Habitat International*, Vol. 18, No. 2, pp. 41-56, [https://doi.org/10.1016/0197-3975\(94\)90049-3](https://doi.org/10.1016/0197-3975(94)90049-3).
- Ofori, G. (2007) Construction in developing countries. *Construction Management and Economics*, Vol. 25, Issue 1, pp. 1-6.
- Ofori, G. (2012a) *New Perspectives in Construction in Developing Countries*. Taylor and Francis, Abingdon.
- Ofori, G. (2012b) *Contemporary Issues in Construction in Developing Countries*. Taylor and Francis, Abingdon.
- Ofori, G. (2015) Nature of the construction industry, its needs and its development: a review of four decades of research. *Journal of Construction in Developing Countries*, 20(2), 115-135.
- Ofori, G. (2016) Construction in developing countries: current imperatives and potential. *Proceedings of the CIB World Building Congress 2016*, ed. Kähkönen, K. and Keinänen, M., Tampere University of Technology, Vol. 1, 39-52. Tampere, Finland, 30 May to 3 June.
- Ofori, G. (2019) Construction industries in developing countries: need for new concepts. *Journal of Construction in Developing Countries*, 23(2), 1-6.
- Ofori-Kuragu, J.K., Owusu-Manu, D-G., and Ayarkwa, J. (2016) The case for a construction industry council in Ghana. *Journal of Construction in Developing Countries*, 21(2): 131-149. <https://dx.doi.org/10.21315/jcdc2016.21.2.7>.
- Project Management Institute (2017) *A Guide to the Project Management Body of Knowledge (PMBOK Guide)*, Sixth Edition, Upper Darby, PA.
- PwC (2014) *Fighting Corruption and Bribery in the Construction Industry*. London.
- Rasmussen, H. and Jensen, P. (2020) A facilities manager's typology of performance gaps in new buildings. *Journal of Facilities Management*, Vol. 18 No. 1, pp. 71-87, <https://doi.org/10.1108/JFM-06-2019-0024>

- Rondinelli, D. A. (1976) Why development projects fail: problems of project management in developing countries. *Project Management Quarterly*, 7(1), 10-15, <https://www.pmi.org/learning/library/problems-project-management-developing-countries-1739>
- Ruddock, L. and Lopes, J. (2006) The construction sector and economic development: the 'Bon curve'. *Construction Management and Economics*, Vol. 24, Issue 7, pp. 717-723.
- Rwelamila, P.D. (2012) Construction project performance in developing countries, in Ofori, G. (ed.) *Contemporary Issues in Construction in Developing Countries*, Spon Press, New York, pp. 318-346.
- Rwelamila, P.D. and Ogunlana, S. (2015) W107 – Construction in Developing Countries Research Roadmap - Report for Consultation. International Council on Research and Innovation in Building and Construction (CIB), Rotterdam.
- Rwelamila, P., Talukhaba, A. and Ngowi, A. (1999) Tracing the African Project Failure Syndrome: the significance of 'ubuntu'. *Engineering, Construction and Architectural Management*, Vol. 6, No. 4, pp. 335-346, <https://doi.org/10.1108/eb021122>
- Strassman, W.P. (1970) The construction sector in economic development. *Scottish Journal of Political Economy*, Vol. 17, Issue 3, pp. 391-409.
- Stuckenbruck, C. and Zomorrodian, A. (2017) Project management: the promise for developing countries, *International Journal of Project Management*, Vol. 5, Issue 3, pp. 167-175, [https://doi.org/10.1016/0263-7863\(87\)90022-6](https://doi.org/10.1016/0263-7863(87)90022-6)
- Syagga, P.M. (1993) Promoting the use of appropriate building materials in shelter provision in Kenya. *Habitat International*, Volume 17, Issue 3, pp. 125-136.
- Tembo, S. and Blokhuis, B. (2004) *Manual for Supervision of Labour Based Road Rehabilitation Works*. ILO ASIST, Harare.
- The Economist Intelligence Unit (2017) *The Critical Role of Infrastructure for the Sustainable Development Goals*. London.
- The KPI Team (2019) *UK Industry Performance Report 2018*. Glenigan, Constructing Excellence, Department for Energy, Business, Energy and Industrial Strategy, London.
- The Senate Economics References Committee (2015) *Out of reach? The Australian housing affordability challenge*. Commonwealth of Australia, Canberra.
- Turin, D.A. (1969) *The Construction Industry: Its economic significance and its role in development*. Building Economics Research Unit, University College Environmental Research Group, London.
- Turin, D.A. (1973) *Construction and Development*. Building Economics Research Unit, University College Research Group, University College London.
- United Nations (2017) *New Urban Agenda*. New York.
- United Nations (2018) *Sustainable Development Goals Report 2018*. New York.
- United Nations (2019) *The Sustainable Development Goals Report 2019*. New York.
- United Nations Centre for Human Settlements (1992) *Technology in Human Settlements: The role of construction*. Nairobi.
- United Nations Centre for Human Settlements (1996) *Policies and Measures for Small Contractor Development in the Construction Industry*. Nairobi.



- United Nations Industrial Development Organisation (UNIDO) (1969) *Industrialization of Developing Countries: Problems and prospects – Construction Industry*, Monograph No. 2, UNIDO, New York.
- UNIDO and International Centre for Science and High Technology (2008) *Available Technologies for Local Building Materials*. International Centre for Science and High Technology, Trieste.
- United Nations Task Team on Habitat III (2017) *One United Nations for Habitat III*. United Nations, New York.
- University College London (UCL) (2018) *Construction Economics and Management MSc*, <https://www.ucl.ac.uk/prospective-students/graduate/taught-degrees/construction-economics-management-msc>
- Watermeyer, R. (2018) *Client Guide for improving Infrastructure Project Outcomes*. Engineers Against Poverty and University of the Witwatersrand, Johannesburg.
- Wells, J. (1986) *The Construction Industry in Developing Countries: Alternative strategies for development*. Croom Helm, London.
- Windapo, A.P. and Rotimi, J.O. (2012) Contemporary issues in building collapse and its implication for sustainable developments. *Buildings*, 2(3): 283-299. <https://doi.org/10.3390/buildings2030283>.
- World Bank (1984) *The Construction Industry: Issues and strategies in developing countries*. Washington, D.C.
- World Bank (2017a) *The World Bank Environmental and Social Framework*. Washington, DC.
- World Bank (2017b) *Uganda Transport Sector Development Project: Fact Sheet (Updated)*, <https://www.worldbank.org/en/country/uganda/brief/uganda-transport-sector-development-project-fact-sheet>
- World Bank (2017c) *Why We Need to Close the Infrastructure Gap in Sub-Saharan Africa*. April, <http://www.worldbank.org/en/region/afr/publication/why-we-need-to-close-theinfrastructure-gap-in-sub-saharan-africa>
- World Bank Data Team (2019) *New country classifications by income level: 2019-2020*, <https://blogs.worldbank.org/opendata/new-country-classifications-income-level-2019-2020>
- Youker, R. (2007) *Managing projects financed by international lending agencies*. In Cleland, D.I. and Ireland, L.R. (eds) *Project Manager's Handbook: Applying best practices across global industries*. McGraw Hill, New York.



---

## CONTRACTORS' SELECTION AND ITS EFFECTS ON WATER INFRASTRUCTURE DELIVERY

Mkasi P.<sup>1</sup>, Ogbeifun E.<sup>2</sup> and Pretorius J. H. C.<sup>3</sup>

<sup>1,2,3</sup>*Postgraduate School of Engineering Management, Faculty of Engineering and the Built Environment, University of Johannesburg, South Africa.*

Recognising the impact of the dearth of water infrastructure on the economy and social wellbeing of the citizens, the government of South Africa has continued to invest in the development of suitable water infrastructure. Unfortunately, the current pace of water infrastructure delivery is not complementary to the investment made, due to an ineffective procurement system that fails to produce quality performing contractors. The work quality of contractors influences the successful execution of infrastructure delivery. Therefore, it is imperative to evaluate the current procurement system. In this research, the single site case study method of qualitative research was adopted. Semi-structured questionnaires, complemented by interviews, were used as instruments for data collection. The participants were drawn from the supply chain management functions unit, the bid adjudication committee, technical team, consultants, and contractors. The findings revealed that the combined effects of the use of an ineffective procurement system and low capacity of professionals in the in-house team of the client have contributed to the delays in procuring the services of the specialist sub-contractors required for the execution of the rehabilitation scheme of the Clanwilliam Dam project. Therefore, this research recommends the adoption of contractors 'pre-qualification to facilitate the selection of quality contractors as well as to increase of the capacity of the in-house professionals.

Keywords: Clanwilliam dam, contractors 'pre-qualification, selection of quality contractor, procurement process, water infrastructure delivery

### INTRODUCTION

Water is a basic resource necessary for life, energy, farming and other economic growth. While water is needed for various uses, it is a scarce resource that is unequally distributed and, most of the time, used inefficiently. South Africa receives an annual average rainfall of 465 mm, which is about half of the world's average of 860 mm (DWS, 2019). The effective management of this resource is necessary to meet the current and future water demand. Water infrastructure is built by the government to regulate, monitor and provide clean water to all users. The infrastructure includes dams, pipelines, water treatment plants and canals. Water

---

<sup>1</sup> Mkasineli27@gmail.com

<sup>2</sup> Edogbe2002@yahoo.com

<sup>3</sup> jhcpretorius@uj.ac.za

infrastructure is capital intensive in terms of development, operation and maintenance. The critical phases of design, construction, operation and maintenance of water infrastructure require a team of highly skilled human capacity of diverse professionals. If these professional human capacities are not integral to the in-house team of the organisation (such as the National Department of Water and Sanitation – NDW&S), their services can be sourced through appropriate procurement systems. However, when the procurement process is not effectively managed, it could lead to engaging incompetent professionals, low skilled consultants, and poor-quality contractors. The net effect of this action results in the delays in water infrastructure delivery, loss of investments and revenue.

The background to this research is the execution of the rehabilitation project of the Clanwilliam Dam. The Clanwilliam Dam was built in 1935 on the Olifants River in the Western Cape, near the town of Clanwilliam. Safety inspections on the dam showed that remedial work is required to stabilise the dam wall distortions. In addition to strengthening the existing wall, it was decided to increase the storage capacity of the Dam. The proposal included raising the dam wall by 13 m, which would provide an additional storage capacity of 70 million m<sup>3</sup> per annum. This would improve the reliability of water supply, provide additional resources to farmers and enhance the tourism potential of the benefiting municipalities. A feasibility study confirmed that the rehabilitation was both technically feasible and economically viable. The design of the rehabilitation scheme was prepared by the in-house engineering department of the National Department of Water and Sanitation, Infrastructure Development Unit, with professional inputs from a specialist consulting civil engineering firm.

The contract for the rehabilitation project was awarded to the in-house construction management unit of NDW&S, as the main contractor for the project. Work on the project officially commenced in October 2018 and was scheduled to be completed in 48 months. However, before the commencement of work, the contractor requested the appointment of sub-contractors necessary to execute specialist work before and during the rehabilitation process. The three critical specialist service providers required were:

- Drilling and blasting,
- Drilling and grouting of the foundation, and
- Preparation of concrete surfaces.

Subsequently, the tender documents for each specialist's work were submitted to the procurement unit. Unfortunately, by June 2019, none of the sub-contractors had been appointed. These delays have had negative impacts on the project timeline and contract price.

Therefore, this paper explores the factors responsible for the delays in the execution of the Clanwilliam rehabilitation plan.

## LITERATURE REVIEW

The success of infrastructure delivery depends significantly on the quality of contractors. The three performance indicators of time, cost and quality, commonly referred to as the iron triangle, have been used as the factors for measuring project success in the last couple of decades (Atkinson, 1999). However, Toor and Ogunlana (2010), suggest that these performance measures can no longer be the sole determinant of project success, in view of current realities. In their opinion, other factors that should be considered in the discussion are safety, efficient use of resources, effectiveness, satisfaction of stakeholders and reduced conflicts. According to Tookey et al. (2001), the correct selection of the procurement method is fundamental to a successful selection of the project execution team (PET) members, especially the contractors (Mchopa, 2015). Therefore, a successful procurement exercise should commence at the selection of appropriate and suitable procurement route(s).

### Selecting procurement route

The process of selecting the appropriate procurement system depends on the client's objectives. According to Oyegoke et al. (2009), the construction procurement priorities of the client are shifting from lowest cost to best value procurement. In the opinions of Ruparathna and Hewage, (2015), procurement is an avenue that integrates value for money (VFM), sustainability and safety into a construction project. A project's VFM performance relies on the procurement method (open, restricted, etc.) and the procurement route selected, for example, the traditional design, bid and build (DBB) system (Escamilla and Ostadalimakhmalbaf, 2016), the design and build (DB) system (Idoro, 2012), or the relationship-based procurement system (Jefferies et al., 2014). Seeking the best VFM requires, among other things, diligent procurement planning and design. Marinelli and Antoniou (2019) noted that, although procurement options are well established in terms of procedure, organisation and governance, many of the procurement exercises (especially through the traditional procurement system) have failed to produce the best VFM, because of the practice of patronising the lowest bidder (Deep et al., 2017).

Procurement has the potential to impact on public project performance, because the process determines the quality of the PET, which includes the consultants and contractors. The construction project delivery system has changed over the past decades, transitioning from traditional procurement to the introduction of a range of alternatives which include design and build, design-build-maintain, private finance initiative, and partnering and project alliancing (Walker and Hampson, 2003). Clients are advised to choose the procurement route which best suits the needs of the project. To select a quality contractor for the effective execution of water infrastructure projects, the procurement process should begin with the pre-qualification of suitable contractors.

### The influence of pre-qualification of contractors in an effective procurement system

The selection of quality contractors holds the potential of engaging adequately resourced contractors, knowledgeable in the project at hand, reducing the

incidence of rework, capable of producing an overall quality project, which is delivered within schedule, reasonable cost and enabling the client to achieve VFM (Jafari, 2013; Ruparathna and Hewage, 2015). Therefore, it is necessary to introduce systems that will assist in filtering prospective contractors, with the aim of selecting the most suitable one(s) for the infrastructure type to be executed. This filtering process is commonly referred to as the 'pre-qualification' process. To achieve good results in the pre-qualification process, Jafari (2013), proposed a pre-qualification model which uses the Quality Function Method. This model considers both the client's requirement and the contractor's capabilities, focusing on the contractor's capacity to perform, evidence from previous projects executed and financial stability as tools to identify a suitable contractor. The information in the pre-qualification document should be comprehensive. The process should include a detailed examination of the documents submitted by each contractor, complemented by physical verifications. The category or categories of contractors to be invited for pre-qualification should be specified, so that the shortlisted contractors will be approximately equal in capacity and capability (Ogbeifun et al., 2018). At the end of the pre-qualification process, a shortlist of suitable contractors is produced. The shortlisted contractors are then invited to tender for the construction project. This approach holds the potential of selecting quality contractors, simplifying the process of tender evaluation, providing an opportunity to examine the technical competency, balanced pricing and a workable schedule or project timeline of the contesting contractors. This process should lead to objective decisions on the chosen contractor(s) (Jafari, 2013).

## **RESEARCH METHOD**

The aim of this research is to explore the impact of the selection of suitable contractors on the effective execution of water infrastructure projects. The case study method of qualitative research was considered as the most suitable to answer the research questions as the case study strategy is suitable for the in-depth study of the different perceptions and concerns of the research participants in a real-world situation (Yin, 2014). In addition, it focuses on responding to the how and why questions about contemporary occurrences or systems and improving systems or organisations (Yin, 2014). Procuring the services of suitable contractors to execute the rehabilitation project of the Clanwilliam Dam is a real problem in a real world.

### **Population, sample and sampling**

The population for this research was all the staff of the Department of Water and Sanitation responsible for infrastructure development. However, due to resource and time constraints, the purposive method of sampling (Day and Bobeva, 2005) was used to select participants (influenced by the role they play), from the supply chain management function, technical team, heads of departments, contractors and consultants directly involved with the rehabilitation project of the Clanwilliam Dam. The 15 officials, shown in Table 1, who responded to the invitation are highly knowledgeable about the subject of the research and actively participated in the research exercise.

**Table 1 Participants**

S/No	Cluster	Number selected	Designation
1	Selected Heads of Unit/Division		
1a	Mechanical and Electrical	1	Senior Management.
1b	Integrated Environmental Engineering	1	Senior Management
1c	Infrastructure Development	1	Engineer
1d	Strategic Asset Management	1	Senior Management
1e	Hydrological Services	1	Senior Management
1f	Supply Chain Management	2	Senior Management
2	Technical Team	3	Engineers
3	Contractor	3	Project Manager and Engineers
4	Consultant	2	Project Manager and Engineer
	Total	15	

In qualitative research, there are no strict rules on the sample size, the principle is to attain 'saturation 'of information from a truly representative population (Hennink et al., 2011). Nevertheless, when using homogeneous samples, the participant size of 6-8 is ideal. Nevertheless, a sample of 12 or more may be necessary when dealing with heterogeneous population (Zyzanski et al., 1992). The participants for this research are considered heterogeneous because they are from different professional backgrounds and perform different functions in the Clanwilliam Dam rehabilitation project. The goal is not to increase the quantity of the sample but to concentrate on the quantity and diversity of information to be collected, that effectively address the research questions (Hennink et al., 2011).

**Data collection and analysis**

The data was collected in two stages, first using a semi-structured questionnaire with open-ended questions to collect preliminary information from participants. Secondly, one-on-one interviews were conducted with one selected individual within these clusters:

- i. Engineering (Mechanical/Electrical)
- ii. Infrastructure (Asset management, Integrated environment
- iii. Hydrological services
- iv. Supply chain management
- v. Technical team

The semi-structured questionnaires were delivered to the respondents electronically, commonly referred to as 'the self-administered questionnaire (Yin, 2009). The questions were open-ended, which allowed an elaborate account from respondents. After the analysis of the preliminary data, face-to-face interviews of forty minutes each were held with five (5) participants from the specified clusters above. This second phase of data collection was done to enable these key participants to provide additional and succinct information necessary to answer the research questions. The principles of content analysis of qualitative data were used in the analysis of the information collected (Hsieh and Shannon, 2005).

To ensure the reliability and validity of the research, participants were drawn from the strategic and tactical levels of leadership as they are knowledgeable about the subject of the research (Hsieh and Shannon, 2005). The information provided by the respondents and the synthesis of the researcher were circulated to respondents for confirmation of accuracy in interpretation.

The details of the data collected, and the results of the analysis are shown in the findings and discussion section.

## FINDINGS AND DISCUSSIONS

This section provides the information gathered from the participants using the two instruments for data collection, their analysis and discussions of best practices gleaned from literature, starting with the background to the research.

### Findings and analysis

An excerpt of the data collected from the interview responses and the analysis is shown in Table 2. For the sake of brevity, this paper will focus on the Questions 1-6, which are relevant to the procurement process and the impact of contractor selection on infrastructure delivery. According to Wong, (2008), qualitative data analysis involves making sense of the vast amount of data by reducing the volume of raw information, followed by identifying important patterns, extracting meaning from the data, and creating a logical chain of evidence. The principle of content analysis of qualitative data was used for the purpose of summarising and tabulating data. The analysis of the data collected provides an explanation, understanding or interpretation of participants' experiences and situation (Sunday, 2019). The synthesis from the analysis of respondents' information led to the identification of suitable themes. The three themes identified and discussed in this paper are: Procurement management and improvement require end-user's involvement, Quality contractors enhance project delivery and Pre-qualification of contractors, as shown in Table 2.

### Discussion of findings

The research findings, summarised as suitable themes (Table 2), are procurement management and improvement require end-user's involvement; quality contractors enhance project delivery, and pre-qualification of contractors. These themes are discussed in the following sub-sections.

#### ***Procurement management and improvement require end-user's involvement.***

The above theme is the product of information gleaned from responses to survey Questions 1, 2, 3 and 4. The participants observed that there are inherent deficiencies in the current procurement process, noting that relevant internal units of end-users are not involved early in the project procurement process. They further opined that the deficiencies in the procurement process "have not been able to address the issue of selecting poor performing contractors". The desire to improve the infrastructure delivery processes in South Africa has led to the development of the Standard for Infrastructure Procurement and Delivery Management (SIPDM). It was meant to guide public institutions on procurement practices in the delivery of suitable infrastructure and provide contract management standards that will ensure value for money and on-time delivery

(National Treasury, 2016). Nevertheless, participants observed the following, as major, deficiencies in the current procurement system:

- No clear implementation processes.
- Lack of training in the use of SIPDM.
- Over centralisation of supply chain management (SCM).
- Low input from operators of procurement system when developing new ones.

This suggests that, if meaningful improvements in the procurement system are to be achieved, it requires timely and active participation of the end-users, where their experience and areas of concern in previous endeavours are highlighted. These observations should be carefully crafted into the development of new systems. The procurement documents and procedures should be user friendly, with reduced technical difficulties, incorporating adequate training for prospective users. Furthermore, the current practice (over-centralisation of operations), where the procurement process is managed by the SCM unit established by Treasury, is slowing down effective procurement performance.

**Table 2. Analysis of responses**

Interview Questions	Synthesis of Participants' Response	Suitable Theme
1. In your opinion, what do you think are the causes of the delays in the execution of water projects in this department, especially the rehabilitation of Clanwilliam Dam	Deficient procurement process: Internal procedures not involved early in project procurement. Poor planning and budget constraints; Low professional capacity.	Procurement management and improvement require end-user's involvement
2. In your opinion, has the selected method of procurement been able to effectively deliver technical services needed for the raising of Clanwilliam?	No; The procurement system has not addressed the issue of poor performing contractors; The consultants are lagging in enforcing quality assurance; Tenders cancelled due to errors in specifications.	
3. How involved is internal audit in the process of water infrastructure procurement?	Internal procedures are not involved early in project procurement; Difficulty in cost control; Incomplete bill of quantities, frequent variation orders.	
4. There have been several improvements on the infrastructure procurement system (SIPDM), have these improvements translated to effective delivery of water infrastructure and why?	Although SIPDM was supposed to be an improvement on previous procurement systems, no clear implementation process; Lack of training in the use of SIPDM; Low input from operators of the procurement system in the development of new ones; Decentralisation of supply chain management to the end-user; Due to faults in SIPDM, FIDPM was introduced in 2019.	
5. What are the impacts of the quality of selected contractors on effective water project delivery?	With quality contractors, projects are delivered on time, within cost, safety and with quality; Low operation and maintenance costs; Meet national objectives; Improve service delivery and satisfy water demand.	Quality contractors enhance project delivery
6. What additional processes do you suggest we can introduce into the procurement system that will assist in the selection of competent contractors?	Adapt CIDB construction procurement process; Conduct contractors' pre-qualification first before invitation to tender; Assess the competence and performance capabilities of contractors.	Pre-qualification of contractors



In the opinion of reference (Atkinson, 1999), a decentralised SCM system, in most cases, produces optimal results. This is in tandem with the suggestion of participants that “supply chain management (SCM) should be decentralised to the end-users”. This approach will allow for the adaptation of procedures peculiar to respective end-users and their projects, with the potential of the speedy execution of the procurement process. It is, however, crucial that SCM decentralisation obtains organisational support and the deployment of skilled SCM practitioners. This will facilitate the procurement of suitable service providers for the execution and effective delivery of the much-needed water infrastructure.

During the continuous search for the improvement of infrastructure delivery, the SIPDM was amended and in 2019 replaced by the Framework for Infrastructure Delivery and Procurement Management (FIDPM). According to the National Treasury, changes were made to the SIPDM system due to misalignment with other relevant government policy prescripts (National Treasury, 2019/2020). The objectives of FIDPM are to promote VFM in all the phases of infrastructure delivery, as well as the allocation of responsibilities for decision making to definite persons or portfolios. Like the deficiencies observed with the implementation of the SIDPM system, the new FIDPM may not achieve the desired objectives if the SCM processes are not decentralised and the end-users adequately empowered to use the new scheme. Nevertheless, to achieve success in infrastructure delivery, the participants believed “clients or project coordinators should be actively involved in the development or amendment of the procurement system and the decision on the selection of the most appropriate project procurement route”. The chosen procurement route should produce a quality contractor suitable for the execution of the project at hand.

### ***Quality contractors enhance project delivery***

The role of the contractor is central to the realisation of the construction project's objectives. It therefore suggests that stakeholders should be meticulous in the process of selecting suitably qualified contractor(s). The participants affirmed this position, noting that when a quality contractor is selected, a “project can be delivered timely, within cost allocated, quality specified, executed safely and environmental regulations compliant”. Research evidence abounds that the use of the concept of the price of the ‘lowest bidder’ as the determining factor to award a contract has fatal flaws, resulting in the execution of low-quality work with high life-cycle cost (Jafari, 2013). In South Africa and other developing countries, emphasis on the capability of the contractor should include the quality and quantity of relevant equipment, personnel and previous projects completed. In this regard, it is important to commence the process of contractor selection from the pre-qualification process.

### ***Pre-qualification of contractors***

The contractor is the most visible active force on the construction site among the PET members. Therefore, the selection of this group of actors requires careful consideration (Ogbeifun et al., 2018). Contractor selection involves a multi-faceted decision-making process with multiple selection criteria. In practice, the contractor selection process follows a two-stage process, known as the pre-qualification and post-qualification stages (Jafari, 2013). The pre-qualification process involves inviting many contractors to submit the information required by the procuring

client, so that an array of eligible contractors can be identified (Jafari, 2013). The client should provide comprehensive information in the pre-qualification document, followed by a detailed examination of the documents submitted by each contractor and physical verification, in terms of completed projects, the company's profile and financial capacity. The document should specify the boundaries for the prospective contractors to be invited for the pre-qualification exercise to ensure that the shortlisted contractors will be operatives of similar capacity and capability (Ogbeifun et al., 2018).

Furthermore, participants observed that one of the major setbacks in the process of selecting the specialist contractors required for the rehabilitation exercise of the Clanwilliam Dam was that "prospective contractors, invited to tender for the specialist services, did not meet the requirements stipulated by CIDB". These facts were only discovered at the bid evaluation stage. If the client had adopted the concept of pre-qualification of contractors before the invitation to tender, the problem of prospective contractors not meeting the required grading criteria of CIDB would have been avoided.

## **CONCLUSIONS AND RECOMMENDATIONS**

The research focused on exploring the factors responsible for the delays in the execution of the rehabilitation work on the Clanwilliam Dam project. A feasibility study was conducted, which confirmed that the proposed rehabilitation exercise was both technically feasible and economically viable. The decision to execute the rehabilitation exercise through in-house units was made to save money. However, the project awarded, scheduled to commence in October 2018 and be completed within 48 months, had hardly taken off as of December 2019. This is largely because of the late discovery of the need for sub or specialist contractors.

The factors responsible for the delays were explored and found to include the deficiencies in the current procurement system and lack of sifting of prospective contractors. It was discovered that the procurement system does not have a clear implementation process; it encourages over-centralisation of SCM, does not provide for continuous training nor does it incorporate the opinions of end-users. As a result of the lack of comprehensive tender document, it only became obvious at the bid evaluation stage that the majority of the contractors did not satisfy the criteria for the level of work they were bidding for. The conclusion is that the delay in appointing quality specialist contractors for the execution of the Clanwilliam Dam rehabilitation exercise is due to the combined effects of a defective procurement system and the low human capacity of cognate professionals in the in-house team of the client. Therefore, this research recommends the adoption of the concept of pre-qualification of contractors to ensure that only contractors with acceptable criteria, capacity and capabilities are invited for the tender process. Secondly, the client should improve on the human capacity of the in-house team in all areas of procurement management.

## REFERENCES

- Atkinson, R., (1999), Project management: cost, time and quality, two best guesses and a phenomenon, it's time to accept other success criteria *International Journal of Project Management* vol. 17, no. 6, pp 337–342.
- Day, J., & Bobeva, M. (2005), Generic toolkit for the successful management of Delphi studies *The Electronic Journal of Business Research Methodology* vol. 3, pp. 103–116.
- Deep, S., Bilal, M., & Ahmad, S. (2017), A study of various factors affecting contractor's performance in lowest bid award construction projects *International Journal of Civil Engineering and Technology* vol. 8, No. 2, pp 28–33.
- DWS, (2019), National Water and Sanitation Master Plan Available <http://www.dwa.gov.za/National%20Water%20and%20Sanitation%20Master%20Plan/Documents/NWSMP%20Call%20to%20Action%20v10.1.pdf>, Accessed 14 June 2019.
- Escamilla, E. F., & Ostadalimakhmalbaf, M. (2016), Capacity building for sustainable workforce in the construction industry *The American Institute of Constructors* vol. 41, no. 1, pp 51–70.
- Hennink, M., Hutter, I., & Bailey, A. (2011), *Qualitative Research Methods*, London, SAGE.
- Hsieh, H. F., & Shannon, S. E. (2005), Three approaches to qualitative content analysis *Qualitative Health Research*, vol. 15, no. 9, pp. 1277–1288.
- Idoro, G. (2012), Comparing levels of use of project plans and performance of traditional contract and design-build construction projects in Nigeria. *Journal of Engineering, Design and Technology* vol. 10, no. 1, pp 7–33.
- Jafari, A. (2013), A contractor pre-qualification model based on the quality function deployment method *Construction Management and Economics*, vol. 31, no. 7, pp. 746–760.
- Jefferies, M., Brewer, G. J., & Gajendran, T. (2014), Using a case study approach to identify critical success factors for alliance contracting *Engineering, Construction and Architectural Management* vol. 21, no. 5, pp 465–480.
- Marinelli, M., & Antoniou, F. (2019), Improving public works' value for money: a new procurement strategy *International Journal of managing projects in business* vol. 13, no. 1, pp. 85–102.
- Mchopa, A. (2015), Integrating contract management practices into achievement of value for money in Tanzania public procurement: evidence from selected procurement entities in Moshi Municipality *Journal of Public Procurement*, vol. 15, no. 2, pp 129–149.
- National Treasury, (2016, July 1). National Standard for Infrastructure Procurement and Delivery Management. Available online at: [www.treasury.gov.za: http://www.treasury.gov.za/legislation/pfma/TreasuryInstruction/Annexure%20A%20-%20Standard%20for%20Infrastructure%20Procurement%20and%20Delivery%20Management.pdf](http://www.treasury.gov.za: http://www.treasury.gov.za/legislation/pfma/TreasuryInstruction/Annexure%20A%20-%20Standard%20for%20Infrastructure%20Procurement%20and%20Delivery%20Management.pdf), Accessed 31 April 2019.
- Ogbeifun, E., Mbohwa, C., & Pretorius, J. H. C. (2018), The influence of stakeholders' relationship on project success *Proceedings of the International Conference on Industrial Engineering and Operations Management Pretoria South Africa*, October 29–1 November 2018, pp 185–194.

- Oyegoke, A. S., Dickinson, M., Khalfan, M. A., McDermott, P., & Rowlinson, S. (2009), Construction project procurement routes: an in-depth critique. *International Journal of Managing Projects in Business* vol. 2, no. 3, pp 338–354.
- Ruparathna, R., & Hewage, K. (2015), Review of contemporary construction procurement practices *Journal of Management in Engineering* vol. 31, no. 3, pp 1–11.
- Sunday, C. E. (2019), Qualitative data analysis Available [https://www.uwc.ac.za/Student/Postgraduate/Documents/Qualitative\\_data\\_analysis.pdf](https://www.uwc.ac.za/Student/Postgraduate/Documents/Qualitative_data_analysis.pdf), Accessed 24 June 2020.
- Toor, S., & Ogunlana, S. (2010), Beyond the iron triangle: stakeholder perception of key performance indicators (KPIs) for large-scale public sector development projects *International Journal of Project Management* vol. 48, pp 229–236.
- Tookey, J. E., Murray, M., Hardcastle, C., & Langford, D (2001), Construction procurement routes: re-defining the contours of construction procurement *Engineering, Construction, and architectural Management* vol. 8, no. 1, pp 20–30.
- Walker, D., & Hampson, K. (2003), *Procurement strategies: a relationship-based approach*, UK London, Blackwell Science.
- Wong, L. P. (2008), Data analysis in qualitative research: a brief guide to using NVivo, *Malaysian Family Physician: The Official Journal of the Academy of Family Physicians of Malaysia*, vol. 3, no. 1, pp 14–20.
- Yin, R. K. (2009), *Case Study Research: Design & Methods* 4th edition, California, SAGE.
- Yin, R. K. (2014), *Case study research – design and methods* 5th edition, Singapore, SAGE.
- Zyzanski, S. J., McWhinney, I. R., Blake, Jr. R., Crabtree, B. F., & Miller .W, (1992), *Qualitative Research: Perspective on the Future*, In Crabtree B F and Miller W L (ed), *Doing qualitative research*, London, SAGE.



## COVID-19 PANDEMIC AND CO-WORKING ENVIRONMENT: ANALYSIS OF SHARED OFFICE SPACE IN FEDERAL CAPITAL TERRITORY (FCT), ABUJA, NIGERIA

Tosin B. Fateye<sup>1</sup>, Abiodun K. Sodiya<sup>2</sup>, Victoria O. Odunfa<sup>3</sup>, Ayodele A. Ibuoye<sup>4</sup> and  
Adewale R. Adedokun<sup>5</sup>

<sup>1,4</sup>*Department of Estate Management, Kaduna State University, Nigeria*

<sup>2</sup>*Department of Estate Management and Valuation, Moshood Abiola Polytechnic, Nigeria*

<sup>3</sup>*Department of Estate Management, The Polytechnic Ibadan, Nigeria*

<sup>5</sup>*Department of Estate Management, Obafemi Awolowo University, Nigeria*

The study examined the impact on Covid-19 pandemic of shared office spaces business in FCT, Abuja. The host (managers) and the customers (users) of shared office spaces constitute the study population. A total of 16 shared office spaces selected participated in the survey exercise. The choice of selection was based on location i.e. those operating within Central Business District, Abuja and showed interest to participate. All the 16 managers (host) and 58 customers (users) that gave attention to participate were administered with questionnaire. The study employed descriptive statistical tools such as frequency distribution, percentage and weighted mean score (WMS) to analyse the data. The study found that majority of the managers i.e. 56.27% were female, 43.75% were of age bracket 31-40years and 81.75% were HND/B.Sc. school certificate holders. The users were more of male gender (63.79%) with dominance age group of 21-50years representing 89.64% and about 79.31% were holders of HND/B.Sc. certificate. Professions in the real estate industry accounted for 55.75% of the managers' professional background. The start-up/entrepreneurs and freelancer were the major users of the shared office facilities. The reasons for high rate of patronage by the users (WMS) were affordability (4.069), concentration (3.879) and flexibility of time/price plan (3.793). The managers ranked challenges (WMS) such as low patronage/demand (4.688), passive economic activities (4.063) and users' psychological effects (4.000) as the prominent ones faced during the pandemic period. Meanwhile, the COVID-19 safety measures that exhibited prominent impact on the business activities were stay-at-home order and social/physical distancing with respective WMS of 4.438 and 4.125. The study concluded that the negative effects on property market and by extension shared office spaces businesses suggests the need for sustainable policy framework that will protect the economy and by extension real estate sector from the future occurrences of any outbreak of global pandemic

Keywords: challenges, co-working, covid-19, health, shared office

<sup>1</sup> fateyetosin@gmail.com

<sup>2</sup> abiodun.sodiya@googlemail.com

<sup>3</sup> odunfavictoria@gmail.com

<sup>4</sup> ayodele.ibuoye@googlemail.com

<sup>5</sup> daconsulting11gmail.com

## INTRODUCTION

The outbreak of Covid-19 pandemic is rapidly changing the ways of doing business in all sectors of global economy. The increasing fatality rate associated with the novel coronavirus in both the developed and developing countries has necessitated the need for structural adjustment in social interaction especially at crowded places. Local and international health organizations have put in place safety and regulatory measures aimed at reducing the fatality and the widespread of the novel virus. The introduction and strict enforcement of the measures such as stay-at-home order, restrictions on social gathering and crowded places among others have direct or indirect effects on economic sustenance (NDCC, 2020; WHO, 2020).

Meanwhile Verschuur, Koks and Hall (2021) explained that the introduction of Covid-19 health safety protocol and guidelines to be strictly adhered to by the citizens were meant to ensure balance between survival of lives and livelihoods. However, the author further expressed that some measures including ban on movement of goods and services except the essential products, economic short-down, restriction on social gathering, discouragement of crowded places including physical/social distancing have made it difficult for some business such as aviation, transportation, hospitality, agro-allied and real estate businesses to thrive amidst the pandemic period.

For instance Maliszewska, Mattoo and Mensbrugge (2020) study reports 2.0 and 2.5% fall in the respective global and the developing countries below benchmark. Verschuur, Koks and Hall (2021) added that global maritime recorded loss in revenue estimated to be 7.5-9.% and amount to 255-412 US\$ billion. In Nigeria Andam, Edeh, Oboh, Pauw and Thurlow (2020) discovered that for 8-week of lockdown (March-June, 2020) the country GDP fell by 23% at the pandemic period, agro-food system alone fell by 11% and the lockdown scenario contributed 9% to rise in the nation poverty level

The resultant adverse effects of the Covid-19 safety measures were not limited to Nigerian real estate sector. For instance in Lagos State, Oyedeji (2020) reported that real estate market experienced static business transactions at the pandemic period. Similarly, a study by Olanrele and Thontteh (2020) on Covid 19 and new normal in Nigeria property market showed that, at the demand side, the property market experienced low demand of real estate products, while at the supply side; there is a drastic reduction in the investment confidence during the pandemic outbreak.

The attendant effects of the novel coronavirus tend to vary in magnitude and level of significance across the property sub-markets (Deloitte, 2020a). The effects may seem to be more felt on some property sub-market such as co-working shared office facilities. Co-working office space is a new growing concept in real estate industry. The ideal is to provide sharing office facilities for different individuals to work outside conventional office on time schedule and rental basis (Robelski, Keller, Harth and Mache, 2019). The concept was introduced to ensure flexibility of workspace, cost effective and social/business interaction among the co-workers in the community. However, the consequential effects of the deadly coronavirus may

not only defeat the primary objectives of the emerging innovative flexible workplace but can also mar the viability of the investment.

Asides that there is limited empirical studies on relationship between covid-19 and property market compare to a large body of empirical studies in other fields such as medical and science related professions. The few available local studies investigated the impacts on general property market. Therefore, a study to investigate the effects of Covid-19 pandemic on shared office space market especially in one of the Nigerian epicenters such as Federal Capital Territory (FCT), Abuja becomes pertinent; owing to the peculiarities of the co-working environment; and to reveal the emerging issues in the fragile property market.

## LITERATURE REVIEW

### **Impact of Covid-19 pandemic on economy: from global and local perspectives**

Amidst the global discussions on the outbreak and dynamics in the widespread of the novel coronavirus, studies have examined the impact of the global health crises on different economies the across globe. For instance, Ozli and Arun (2020) studied the spillover impact of Covid-19 pandemic on global economy. The authors attempted to know how social distancing policies affect pricing of stocks in capital market. The study discovered that monetary policy decisions, increasing number of lock-down days and travel restriction on international movement have prominent adverse effects on economic activities in the stock market.

In East Asian and Pacific region, Maliszewska, Mattoo and Mensbrugge (2020) modeled the interaction of potential impact of Covid-19 with gross domestic product (GDP) and trade. The study reported that the resultant effects of the global health challenges cause 2% fall in the global GDP below its benchmark. Also about 2.5 and 1.8% decreased in the GDP below minimum benchmark for developing countries and the industrial world respectively. On trade, the authors noted that the worst hit trade were outputs of domestic services and traded tourist services. Similar report was given by Verschuur, Koks and Hall (2021) study. The author revealed that, ports in China, Middle-East and Western Europe were collapsed. Loss of revenue in the global maritime trade was estimate to be 7.5-9.6% and amount to 255-412 US\$ billion

In Nigeria, Andam, Edeh, Oboh, Pauw and Thurlow (2020) studied the impact of Covid-19 on food system and poverty. The authors assessed the implications of lockdown polices on agro-food supply system in the country. The reviewed periods were 8-week lockdown (March-June) and economic recovery period till December, 2020. The study found that the country GDP fell by 23% at the pandemic period, while agro-food system alone fell by 11% and the lockdown scenario contributed 9% rise in the nation's poverty level. Ozili (2020) attempted to examine the interaction between Covid-19 pandemic and economic crisis with a focus on Nigeria experience. The author discovered that spillover effect of Covid-19 pandemic cause a decline in the demand for oil product and disturbed economic activities from taking place.

The negative effects of the pandemic were also empirically noted in the Nigerian real estate market. For instance, Oyedeji (2020) studied how real estate transactions

are being affected by the attendant consequences of COVID-19 health challenges in Lagos property market. The author sampled opinion of estate surveying and valuation firms practicing in Lagos and discovered that office property was the 3rd hardest hit by the pandemic after hospitality and retail property types. Also 77.632% of the respondents agreed to static condition of real estate transaction at the pandemic period. The findings corroborate the result of a study by Olanrele and Thontteh (2020). The study investigated the implications of COVID-19 and 'New Normal' policy for the Nigerian real estate sector. The authors observed a negative effect of the global health crises on property market, with a plunge at the short run, and a capital flight from real estate to digital services investment due to changing working style of people (new normal).

### **Co-working space: concept and characteristics**

Co-working space is a new concept in real estate; changing the working lifestyle of private individuals and corporate organizations in the vast knowledge based economy (Foertsch, 2014 and Spinuzzi, 2012). Co-working space is a shared workspace, office environment, joint use of spaces practically conceived as office renting facilities where different groups such as freelancers, remote workers, start-up entrepreneur and other independent professionals working together in various degrees of specialization (Seo, Lysiankova, Ock, and Chun, 2017 and Foertsch, 2017). The Co-working spaces in a simple form comprises of rented office facilities such as a desk with a wi-fi connection hire by an independent professional to carry out its official daily work.

In the work of Vanichvatana (2018), three major forms of setting up co-working spaces were identified. The first form is shared office which is referred to a situation where a business let/sublet a desk to outsider. The second form is co-working business where a business set-up an office spaces to be hired out by outsider and the third form is co-working incubators i.e. office spaces that are set-up in a form that will accommodate services such as advertising, promotion and training in the rented working space. The author stressed that traditional office space differ from co-workspace in the sense that the conventional workspaces encompass the workspace itself and other complementary offices such as meeting, circulating, waiting, filling and storage spaces which are virtually not part of co-workspace..

In literature, authors from academics and practitioners have shared similar viewed on the purpose of co-working business but divided thoughts on the origin of the concept. For the later, authors including Foertsch and Cagnol (2013) and Spinuzzi, (2012) have linked the origin of co-workspace to recent development in San Francisco in 2005, while Bunnell and Linden (2011) argued that the origin of the concept can be traced backed to DeKoven in 1999. Fost, (2008) and JLL (2016) explained that, co-working environment was first noticed in Berlin in 1995 as a physical location for hackers community, later in New York in 1999 with appreciable co-working environment at West Street, before the concept was officially launched in 2005 in San Francisco following the designated co-working community located in Brad Neuber. However, the concept of co-working spaces has witness appreciable increase in its adoption in most capital cities of the world including the United States, United Kingdom, Asia, Thailand etc. (JLL, 2016; Creffield, 2016; Ewart-James, 2016). The reviewed literature on the impact of COVID-19 pandemic on the global and local economies were summarized in Table 1



### Conventional office vs. Shared office workspace

The need to provide flexible work place that is cost effective to accommodate self-employed small/medium business owners that cannot afford bigger office deals fortified the widespread adoption of shared office workspace in many cities of the world. Vanichvatona (2017) opined that conventional office spaces are characterized with huge operational costs such as electricity, telephone and communication costs, management fee, service charges, and local property tax. However, the huge cost involved in renting and maintaining conventional offices especially in central business districts may overwhelm some categories of office users; denied them of having access to office facilities in some core urban centers to underdo their daily business activities.

The emergence of co-working office space has brought a paradigm shift to office property market. The shared office spaces offer the small/medium scale enterprises that cannot afford to rent an office but are in dire need of office facilities a temporal office accommodation to carry out their business activities at the city centers on time sharing basis. Spinuzzi, Bodrožić, Scaratti and Ivakli (2019), Gandini, (2015) and Spreitzer, Bacevice, and Garrett (2015) posited that some set of users prefer co-work office space to their conventional office settings for some reasons. They include conveniences, concentration, networking and collaboration in co-working community. Other users enjoy patronizing co-working spaces because of their strategic locations to place of interests e.g. independent professionals, freelancers, employee of corporate organizations/company, NGOs and government officers. Yank and Bisson (2019) added that the desired outcomes of either the users or the work engaged within the co-working spaces are geared towards innovations, creativity, collaboration and social well-being of the participants. The concept of co-working space is better explained by the flowchart model developed by Yank and Bisson (2019) shown in Figure 1.

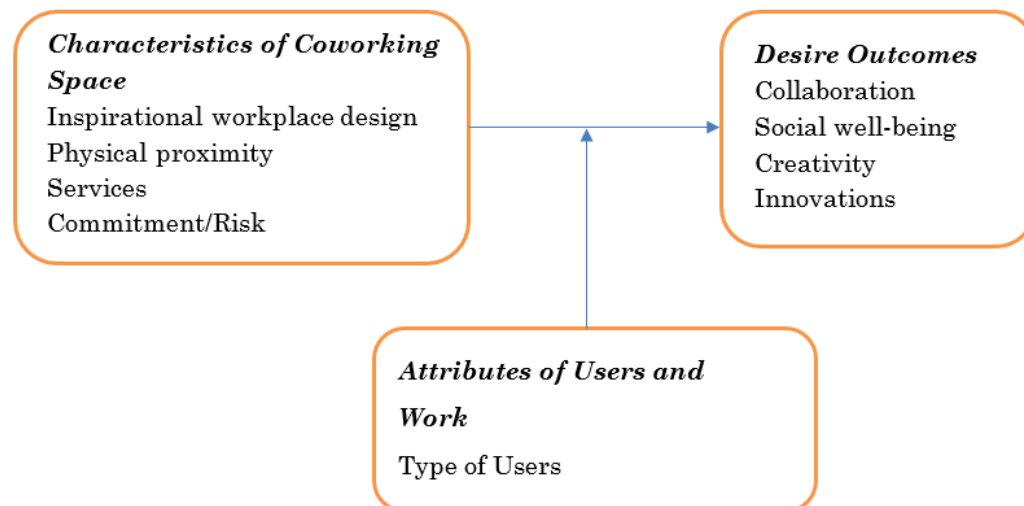

Fig. 1 Co-working space concept

Source: Yank and Bisson (2019)

Vanichvatona (2017) pointed out that, the flexible working environment has its own disadvantages. The author identified the disadvantages of working in co-workspace to include time wasting for unwanted socialization, constant change of

non-fixed chair, privacy, noise and sometimes high cost of renting and commuting to centers where most of the facilities were located especially for small scale business owners. Soe et. al. (2017) surveyed the opinions of both the managers and the users of co-working spaces in South Korea on the important influencing factors. The authors concluded that both the hosts and the users identified relationship facilitation, service diversity and flexible price plan as the prominent influencing factors of sustainable co-workspace operation. The unique characteristics of the co-workspace have strengthened the popularity and widespread adoption of the concept in both development countries and the emerging economies including Nigeria.

For instance, in Nigeria capital territory, Abuja, more than twenty-three (23) shared office spaces are available for patronage. Some of them include Regus City Centre, Ventures Park, Davelt Cospace, Smart Office, Rutyono Office, Work and Connect, Novare Shared Offices, Harmony Innovation Hub, Savvy Instant Offices, Pin Co-working/Co-living, Box Office Hup, Aivon, StoneBricks Hub, Savy Innovation offices, The Ruby centre, Redwoof Place, Civic Innovation Lab etc. all located in Abuja, Nigeria. The shared office spaces are rented on daily, weekly and monthly basis. The rent charge varies across the shared office and largely depends on available facility in the apartment. The range of rent charged par day is #2,000 - #5,000 and for month is #20,000 - #40,000. Figures 3&4 show the example of the settings of shared office space facilities in FCT, Abuja, Nigeria.

**Table 1 Summary of literature reviewed**

Authors	Research Focus	Major Findings	Gap
<i>COVID-19 and Global Economic Crises</i>			
Verschuur, Koks and Hall (2021)	Global economic impacts of COVID-19 lockdown measures stand out in high-frequency shipping data	The authors discovered that manufacturing companies are the hardest hit sector, total collapse of value-chain in the port industry, attributed the negative Covid-19 impact to closure of school and public transport.	The study concentrated on the impact of Covid-19 on shipping service industry
Ozili P. and Arun T. (2020)	Spillover of COVID-19: impact on the Global Economy	Increasing number of lockdown days, monetary policy decisions and international travel restrictions severely affected the level of economic activities and the closing, opening, lowest and highest stock price of major stock market indices	The study examined the global economic situation amidst Covid-19 pandemic.
Maliszewska, Mattoo and Mensbrugge (2020)	The potential impact of COVID-19 on GDP and trade	The study reported a decrease in the global domestic output below global GDP benchmark, with output of domestic services and traded tourist services having the biggest negative impact.	The authors did not examine real estate services in isolation.
<i>COVID-19 Implications on Local Economy: Nigeria Experience</i>			
Andam, Edeh, Oboh, Pauw and Thurlow (2020)	Impacts of COVID-19 on food systems and poverty in Nigeria	The study found that the country GDP fell by 23% at the pandemic period, while agro-food system alone fell by 11% and the lockdown scenario contributed 9% rise in the nation poverty level	The study is limited to food-system sector of the economy

**Table 1 cont'd Summary of literature reviewed**

Ozili (2020)	COVID-19 pandemic and economic crisis: the Nigerian experience and structural causes	The author discovered that spillover effect of Covid-19 pandemic cause a decline in the demand for oil product and disturbed economic activities from taking place.	The result did not specifically address the condition of property market at the pandemic period The office market considered is general and may not depict the true condition of shared office spaces sub-market experience
Oyededeji (2020)	The Impact of COVID-19 on Real Estate Transaction in Lagos, Nigeria	Transaction in hospitality, retail and office property markets experienced prominent impact of COVID-19 pandemic and about 77.63% attested to the static condition of real estate transactions at the pandemic period.	
Olanrele and Thontteh (2020).	COVID-19 and the 'New Normal': Implications for the Nigerian Real Estate Sector	The authors observed a negative effect of the global health crises on property market, with a plunge on the short run, and a capital flight from real estate to digital services investment due to changing working style of people (new normal).	The result lacks empirical basis of assessing real estate sector
<i>Co-working Offices Space: Concept and Characteristics</i>			
Yank and Bisson (2019)	Coworking space as a third-fourth place: changing models of a hybrid space in corporate real estate	The study pointed out that, co-working spaces will grow worldwide reasons attributed to increase in knowledge based economy, digital working lifestyle and mobile technology.	The investigation of co-working spaces is limited to its concept and characteristics
Spinuzzi Bodrozic, Scaratti, and Ivakli (2019)	Community in coworking	Co-working space is driven by the logic of coexisted with another and the logic of collaborative community	The study assessed the attributes of co-working spaces.
Vanichvatana (2018)	Investigating users' Perspectives of coworking Space: Cases of Bangkok CBD	80% of the users visited co-working space, spent minimum of 1 hour per visit with average of 3-4 time per week, while the choice of place is largely depend on location	The users' perception of Bangkok on co-working space is limited to the case study
Seo, Lysiankova, Ock, and Chun, (2017)	Priorities of Coworking Space Operation Based on Comparison of the Hosts and Users' Perspectives	The most important success factors by the hosts were community, communication, space and interior, service diversity and price plane. While the users prioritized relationship facilitation, service diversity, price plane and networking	The study did not considered the impact of external forces on the business performance
Vanichvatana (2017)	Characteristics Of Co-Working Spaces In Bangkok	Most co-working spaces are fixed/hot desk, located at central business districts (CBDs), often provided with Wi fi, snacks, drinks, printing, mail box and projector	Limited to characteristics of co-working space.
Gandini, (2015)	The rise of coworking spaces: A literature review	The study concluded that manifestation of a rethinking work to facilitate network of collaborative production in the core urban centres.	The study deployed context review approach and lack empirical findings

Sources: Authors 'Compilation from reviewed literature, 2021

## MATERIAL AND METHOD

### Study Area

The study used FCT, Abuja, Nigeria as the case study. FCT Abuja is a cosmopolitan city and the seat of federal power in the country. The city has witnessed a strong wave of physical, demographical, social and infrastructure growth and development in the recent decades. FCT Abuja is the home of affluence, political and individual, conglomerate of top government offices, head offices of organisations and potential real estate investment destination. The Abuja property market is characterised with high rent/value. The office sub-market of the city comprises sky scrapers super structure and command higher market rent.

The choice of using FCT, Abuja is attributable to the fact that, FCT has often times reported by the concerned authorities as the second epicenter since the outbreak of the coronavirus after Lagos. For instance, NCDC reported a total case of 67,412 and 87,510 at month end of November and December 2020 respectively. Lagos state recorded the highest case of 23,238 and 30,188 in those two months; followed by Abuja having cases of 6,770 and 11,705. In January 2021, Abuja has 16,565 Covid 19 cases next to Lagos with 47,819 cases out of a total case of 128,674 reported across the country (Nigerian Centre for Disease Control; NCDC, 2020, 2021). The upsurge in the number of cases is attributed to non-adherence to the safety protocol on the part of citizens. This has further strengthened the advocacy on Covid 19 safety protocol particularly in the epicenter with more emphasis on social distancing, wearing of facemasks in the public places, intermittent stay-at-home order among others. As a result, the economic activities in all sectors experienced huge setback including property market such as hospitality, leisure, recreation and shared office facilities but at varying degrees.

### Method

The study is descriptive and non-probabilistic in nature. A purposive sampling technique was used to elicit data from 16 managers (host) and 58 users of selected shared office facilities. The choice of selection was based on location (central capital), those in operation and are willing to participate in the survey exercise. A total of 16 managers (host) of shared offices spaces were administered questionnaire, while some of them that showed interest to be interviewed (less than 20%) were engaged with discussions on the subject matter of the study. For the users, a total of 58 questionnaires were distributed to them with the aid of two trained research assistants, on the permission of the host. Some users declined to participate and gave reasons such as tight schedule and limited time, while other users see the survey as a means of distraction. Therefore, the questionnaire survey was not done proportionately but consideration was given to users that showed interest to participate, and their size vary across the sampled shared office spaces. Also, the period of the field survey exercise which was towards the end of the first wave of the novel coronavirus (September to October, 2020) contributed to the few number of the shared office spaces that opened for business activities and low response rate recorded during the field survey exercise.

The responses gotten from the survey exercise were analyzed by descriptive statistical tools such as frequency distribution table, percentage and weighted mean score (WMS). The study measured the respondents' options on 5-point Likert

scale. The scale with corresponding assigned weight is given as Strongly Disagree (SD: 1); Disagree (D: 2); Unsure (U: 3); Agree (A: 4) and Strongly Agree (SA: 5). The weighted mean score (MWS) can be expressed mathematically as:

$$\text{Weighted Mean Score (WMS)} = \frac{\sum TWF}{N} \text{ ----- eqn (i)}$$

(1 ≤ MWS ≤ 5)

Where

w = assigned weight ranges from 1 (least) to 5 (highest)

TWF = total weighted frequency

N = total number of respondents.

However, for clarity of boundary for proper ranking and rating of the estimated weighted options, the study adapted the ranking demarcation of Rooshdi, Majid, Sahamir, and Ismail (2018). The ranking style was modified to suite the study analysis (see Table 2).

**Table 2: Scale for weighted options**

Likelt Scale	Authors' Specification for RI		Modifications by the study	
	Scale Range	Remarks	Scale Range	Remarks
5	0.8 ≤ RI ≤ 1.0	High	4.1 ≤ WMS ≤ 5.0	Strongly Agreed
4	0.6 ≤ RI ≤ 0.8	High-Medium	3.1 ≤ WMS ≤ 4.0	Agreed
3	0.4 ≤ RI ≤ 0.6	Medium	2.1 ≤ WMS ≤ 3.0	Unsure
2	0.2 ≤ RI ≤ 0.4	Medium-Low	1.1 ≤ WMS ≤ 2.0	Disagreed
1	0 ≤ RI ≤ 0.2	Low	0 ≤ WMS ≤ 1.0	Strongly Disagreed

## RESULTS AND DISCUSSION

The study examined the socio-demographical distribution such as age, gender, marital status and highest educational qualification of those who manage as well as the users of shared office facilities in FCT, Abuja; and the results were presented in Table 3. The age bracket of the managers with highest parentage (43.75%) is 31-40yrs. Second to the age group is 41-50yrs with 37.5%. Age range of 21-30yrs and 51-60yrs represent 12.5 and 6.25% respectively, while none of the managers were found within the age ranges of less/equal to 20yrs or more than 60yrs. For the users of the office facilities, 36.20, 31.03 and 22.41% of them were in the age range 31-40yrs, 21-30yrs and 41-50yrs respectively. Age bracket 51-60yrs accounts for 6.90%, less than equal 20yrs is 3.45% while users' in the age group above 60yrs were not represented.

The gender type of those who manage the facilities are more of female (56.27%) than their male (43.75%) counterpart. While 62.50% of the managers are married; 37.50% are yet to be married. However, the male category of users recorded higher

percent (63.79%) than the female users (36.20%). Lager percent of the users were married (48.27%) and 37.93% of them were singles. Divorce accounted for 8.63% while 5.17% were either widow or widower. Managers that have obtained HND/B.Sc. and M. Sc. account for 81.25 and 18.75%. For the users, 79.31% have possessed HND/B.Sc. while those with M. Sc. degree represent 18.96%.

By implications, the shared office facilities are patronized by all age brackets, whether married or single but at varying degrees; with dominant age group 31-50yrs. This age group dominated the country's workforce in the labour market. The management of the facilities are more of females than the male counterpart and majority of them are single. This may be due to the less rigour and energy demand task characterized with the operations of the time sharing office space system. Also, the unique nature of feminine gender in the area of warm reception could make business owners prefer female to male managers.

**Table 3 Socio-demographical characteristics of the respondents**

Profile	Category	Managers		Users	
		Freq.	%	Freq.	%
Age	<20yrs	-	-	2	3.45
	21-30yrs	2	12.50	18	31.03
	31-40yrs	7	43.75	21	36.20
	41-50yrs	6	37.50	13	22.41
	51-60yrs	1	6.25	4	6.90
	>60yrs	-	-	-	-
	Total	16	100.00	58	100.00
Gender	Male	7	43.75	37	63.79
	Female	9	56.27	21	36.21
	Total	16	100.00	58	100.00
Marital Status	Single	10	62.50	22	37.93
	Married	6	37.50	28	48.27
	Divorcee	-	-	5	8.63
	Widow/widower	-	-	3	5.17
	Total	16	100.00	58	100.00
Highest Educational Qualification	NCE/OND	-	-	-	-
	HND/B.Sc.	13	81.25	46	79.31
	M.Sc.	3	18.75	11	18.96
	Ph.D	-	-	1	1.73
Total	16	100.00	58	100.00	

Source: Authors 'Field Survey, 2020

In Table 4, the study looked into the areas of specialization of the managers especially in the built environment on one hand and the nature of the business activities engage in by the users of the shared office space on the other hand. The result of the analysis showed that, managers with expertise in estate/property management account for 43.75%; those with specialties in facility management profession represent 12.50%. Number of personnel from engineering related field was examined in the course of survey while those managers in the category of 'others' represent 43.75%. This implies that the employment of management

personnel of shared office space facilities is not limited to estate/property management field, as other professions can be employed for the job. Low employment of experts in facility management profession is attributable to the less qualified professionals in the field; and most of the qualified ones engage in managing sophisticated and equipped quipped property such as high rise buildings. Those managers whose their specialization falls in the category of 'others' indicates experts from other professions such as architecture, quantity surveying, building etc. and by extension from accounting, law, businesses administration etc.

From the users' perspective, the study investigates the nature of business engaged in while making use of the facilities. The study found that, 36.21% of the users work as an independent professional/freelance. Users who are identified as start-up/young entrepreneurs represent 25.86%. Those that work with corporate organizations/businesses and the governments represent 22.42 and 20.34% respectively; while 5.17% of the users fall in the 'others' category as shown in Table 4 This result implies that, shared office space facilities are mostly used by individuals who are working independently either as a professional such as experts in ICT related businesses or as a freelance in mass communication/advert industry. The patronage of some users working with national/international corporate bodies and non-governmental organizations (NGOs) were also noted to be substantial. Officials from government ministries, departments and agencies also patronized the office facilities though at relatively lower rate. Therefore, the facilities are available for use to people from all works of life though the rate of patronage vary and largely dependent on their nature of the business activities.

**Table 4 Managers area of specialization and users' nature of business**

Response	Category	Freq.	%
Manages area of specialization	Estate/Property Management	7	43.75
	Facility Management	2	12.50
	Engineering	-	-
	Others	7	43.75
	Total	16	100.00
Users nature of business	Independent professionals/ Freelancer	15	25.86
	Start-Up/Young Entrepreneurs	21	36.21
	Corporate Businesses/ Organizations	13	22.42
	Government Officers	6	10.34
	Others	3	5.17
	Total	58	100.00

Source: Authors 'Field Survey, 2020

Table 5 presents the opinions of the managers on the general performance of the business especially amidst the rising Covid 19 related cases in the epicenter of Abuja. The study examines the public awareness, performance and consequential impacts as well as the likelihood prospects of the business especially at the post Covid era. The managers agreed on the competitive performance (WMS: 4.313) of

the business in the study area though the business was identified to be a young and evolving concept in the office property market (MWS: 3.063). The managers expressed strong agreement on the negative impact of Covid-19 pandemic being felt by all business concerns (WMS: 4.689). However, the manager were optimistic about the possibility of the shared office spaces market to come out stronger and perform better at post-Covid 19 era (WMS: 4.563).

**Table 5 Operations of shared office space market amidst Covid 19 pandemic 19 in FCT, Abuja**

Statements	SD	D	U	A	SA	TWF	WMS	Rating
Covid19 pandemic has negative effects on the operation of the business	-	-	-	20	55	75	4.689	Strongly Agreed
High optimistic about the performance of the market at post-Covid 19	-	-	-	28	45	73	4.563	Strongly agreed
The market perform competitively	-	-	-	44	25	69	4.313	Agreed
Increasing rate of adoption of the office type in FCT, Abuja	1	6	18	24	-	49	3.063	Unsure

Source: Authors' Field Survey, 2020. Note: SD-Strongly Disagreed; Disagreed-D; Unsure-U; Agreed-A; Strongly Agreed-SA; Total Weighted Frequency-TWF; Weighted Mean Score-WMS

In Table 6, further analysis was carried out to know the major reasons why the users prefer the co-working environment like shared office space to conventional office type. The result of the analysis shows that, people choose to patronize and work in shared office space due to some prominent reasons. They are (WMS): affordability (4.069), concentration (3.879), and flexibility of time/time plan (3.793) and strategic location (3.707) ranked 1st, 2nd, 3rd and 4th position respectively; while reasons such as convenience and networking have 3.672 each and occupied 5th position. However, some reasons relating to relaxation/recreation activities (2.448) and study/researching (2.431) were identified to be the least forms of reasons in the study area.

The increasing rate of patronage and users' preference for shared office space in FCT, Abuja is strongly linked to affordability and flexibility of time/price plan in terms of letting and other incidental costs of getting shared office accommodation. Most of the users are either independent professionals/freelance or start-up/young entrepreneurs. These categories of private individuals are attributable to low earning capacity, little capital/finance and largely small scale businesses; and they may not be able to afford the rental price and maintenance of conventional office property especially those located at strategic places in the Central Business Districts (CBD). The users also rate conveniences and concentration as part of the major reasons of patronage; users in this category may include those working with corporate bodies/ NGOs. Some of them secured the office facilities to avoid distraction from friends and colleagues in their conventional office (head/branch offices), while some that considered convenience as top priority could be either those who enjoy working independently or in collaboration with others in such co-working environment.

Another prominent reason that is been considered by users is the strategic location of the facilities to place of interest. Almost all the shared office spaces are located at prime location within the capital territory where economic activities and business



transactions is at pick. However, those small scale business, contracts, professionals, or freelancers that cannot afford to get conventional office space at the city centers of commercial activities often leverage on shared office space facilities present around those areas to do their office work. However, reasons such as relaxation/leisure activities were less important for visiting shared office space. The less significant of these reasons may be attributed to the fact that, share office spaces do not have complementary accommodation to enjoy quiet time for leisure and recreational activities. Studying/researching in a co-working environment may not be encouraging due to the nature of the activities that the facilities were made for. Rather people prefer to visit leisure/recreational centers for fun play or library for academic work.

**Table 6 Reasons for patronage of the shared office facilities by the users**

Reasons	SD	D	U	A	SA	TWF	WMS	Ranking
Affordability	-	-	33	128	75	236	4.069	1
Concentration on job	-	-	57	108	60	225	3.879	2
Flexibility of time/price plan	2	4	48	96	70	220	3.793	3
Strategic location	3	16	18	108	70	215	3.707	4
Convenience	-	-	69	124	20	213	3.672	5
Networking	1	6	48	128	30	213	3.672	5
Office facilities	-	10	42	140	20	212	3.655	7
Recreation/leisure	13	44	21	64	-	142	2.448	8
Studying/research	7	58	36	40	-	141	2.431	9

Source: Authors' Field Survey, 2020 Note: SD-Strongly Disagreed; Disagreed-D; Unsure-U; Agreed-A; Strongly Agreed-SA; Total Weighted Frequency-TWF; Mean Weighted Score-WMS

On the other hand, the views of the managers were examined on some challenges encountered in the operations of the business amidst the rising cases of Covid 19 in the study area. Their submissions were analyzed via WMS and presented in Table 7. The result of the analysis showed that low patronage/demand and passive economic activities were ranked in the 1st and 2nd position having WMS of 4.688 and 4.063 respectively. Users' psychological effects (4.000); increase in maintenance cost (3.873) and decrease in lettable space capacity (3.250) occupied the 3rd, 4th and 5th position. The least challenge experienced by the managers is the low compliance of the users to Covid-19 safety protocol and overstressed office facilities with WMS 1.938 and 1.438 respectively.

Generally, the adverse effects related to Covid 19 outbreak are felt in all sectors of the economic activities across the country. The strong indication of the managers experiencing low level of patronage/demand as a result of passive economic conditions signals that business operations in co-working office sub-market is not an exception to the global health pandemic effects. Like other business, the health crisis caused drastic reduction in the level of users of shared office facilities, which will in turn have negative effect on the return on investment.

Some other prominent challenges are increase in cost of maintenance, users' psychological effect and decrease in lettable space capacity. The need to procure some Covid-19 safety protocol kits such as hand sanitizer, nose mask, water stand for regular washing of hands etc. as mandated by concern authorities will result

into adding extra-cost to the business operations. Also, the regular public orientations about how to contact and preventive measures to be observed to avoid being contacted contribute to reduction in the patronage. The increase in lettable space capacity of the office sharing could be as a result of the need to increase spacing to ensure social distancing.

However, the least forms of challenges identified by the managers are accessibility to safety kits, low compliance with the safety protocol and over stretched facilities. The managers witness less challenges in these area of their business operations because people have been well informed and sensitized through all available media; especially the educated ones, who are extra conscious of getting contracted with the novel coronavirus. To ensure public/community health safety, the non-pharmaceutical Covid 19 prevent kits were made available at affordable rate and accessible to all. Challenges such as overstretched office facilities become insignificant due to low level of patronage experienced as a result of the rising wave of the pandemic.

**Table 7 Challenges of encountered in the operation of shared office space market amidst covid 19 pandemic in FCT, Abuja**

Challenges	SD	D	U	A	SA	TWF	WMS	Rank
Low patronage/demand	-	-	-	20	55	75	4.688	1
Passive economic activities	-	-	6	44	15	65	4.063	2
Users' psychological effects	-	-	9	40	15	64	4.000	3
Increase in the cost of business operation	-	-	12	40	10	62	3.873	4
Decrease lettable space capacity	-	8	18	16	10	52	3.250	5
In accessibility to Covid preventive kits	2	12	9	20	-	43	2.688	6
Low compliance of users' with Covid 19 safety protocol	7	12	3	4	5	31	1.938	7
Overstressed office facilities	10	10	3	-	-	23	1.438	8

Source: Authors' Field Survey, 2020, Note: SD-Strongly Disagreed; Disagreed-D; Unsure-U; Agreed-A; Strongly Agreed-SA; Total Weighted Frequency-TWF; Mean Weighted Score-WMS

Analysis in Table 8 aims at revealing the prominent components of non-pharmaceutical Covid-19 safety measures that affect the operations of shared office space market and to what extent in the study area. The components are stay-at-home order, social distancing, regular washing of hands, use of hand sanitizer and wearing of face mask in public places. The managers ranked the adverse effects of stay-at-home order (4.438) and social distancing (4.125) relatively higher and occupied 1st and 2nd position in that order, while the impact of hand sanitizer (1.567); wearing of face mask in public (1.438) and regular washing of hands (1.375) were rated relatively low and occupied 3rd, 4th and 5th position respectively on the ranking table.

The strict enforcement of stay-at-home order and social distancing become necessary owing to the rising cases of the deadly novel virus in the country. Government was forced to compel people to stay at home and strongly discouraged social gatherings/events in a bid to curtail the virus. But the measures have negative impact on the economy at aggregate level and operation of

businesses including shared office space ventures. However, the less prominent effects of non-pharmaceutical Covid 19 safety measures such as hand sanitizing, washing of hands and the wearing of face mask in public places can easily be complied with without having serious havoc on economic activities.

**Table 8 Non-pharmaceutical Covid 19 protocol affecting operation of shared office space in FCT, Abuja**

Covid 19 Safety Measures	SD	D	U	A	SA	TWF	WMS	Ranking
Stay-at-home order	-	-	-	36	35	71	4.438	1
Social/physical distancing	-	-	9	32	25	66	4.125	2
Hand sanitizing	8	14	3	-	-	25	1.563	3
Wearing of facemask	9	14	-	-	-	23	1.438	4
Washing of hand regularly	10	12	-	-	-	22	1.375	5

Source: Authors 'Field Survey, 2020 Note: SD-Strongly Disagreed; Disagreed-D; Unsure-U; Agreed-A; Strongly Agreed-SA; Total Weighted Frequency-TWF; Mean Weighted Score-WMS

## CONCLUSION AND RECOMMENDATIONS

The study analyzed the attendant effects of Covid-19 pandemic on co-working environment of shared office spaces using FCT, Abuja as a case study. The primary objectives of the study include the operations of the business, users' preference for patronage, impact of the novel coronavirus and associated challenges encountered by the managers. Opinions of the managers and the users of shared office space facilities office were sampled and analysed via descriptive statistics. The study found out that shared office space market is worst hit by Covid-19 pandemic most especially the consequent effects of non-pharmaceutical Covid 19 safety measures such as stay-at-home order and social distancing. However, the users who are majorly independent professionals/freelance and the start-up/young entrepreneurs prefer the co-working environment to conventional office type due to some prominent reasons such as affordability, conveniences, flexibility of time/price plan, concentration on job and strategic location of shared office space facilities to individuals place of interests. The prominent challenges experienced by the managers are low patronage/demand, passive economic activities, increased maintenance cost; while issues relating to adherent to the safety protocol, accessibility to safety kits and overstretched on office facilities were the least challenges in the study area. Conclusively, the wrath of the novel coronavirus dose not spare the emerging and innovative flexible working environment; as worst hit was felt on operations of the shared office spaces and by extension the real estate market generally.

## REFERENCES

- Andam K., Edeh H., Oboh, Pauw K., & Thurlow J. (2020). Impact of COVID-19 on food systems and poverty in Nigeria. *Advances in Food Security and Sustainability*, DOI: 10.1016/bs.af2s.2020.09.002
- Bunnell D., & Linden J. (2011). Is coworking the new incubator? Accessed on: <https://www.deskmag.com/en/coworking-spaces/has-coworking-replaced-the-incubator-175>

- Cagnol, R. (2013). Public support of coworking spaces: The example of France. Accessed on: <http://www.deskmag.com/en/public-support-of-coworkingspaces-the-example-of-france-la-cantine-mutinerie-676>, 1. 10. 2015.
- Creffield, L. (2016). Getting flexible: the rise of coworking in Asia. <https://allwork.space/2016/05/getting-flexible-the-rise-of-coworking-in-asia>
- Deloitte (2020a). Covid-19: Respond, Recover, Thrive: Consideration for the real estate sector. March 20. <https://www2.deloitte.com/global/en/pages/about-deloitte/articles/covid-19/understanding-covid-19-s-impact-on-the-real-estate-sector--.html>
- Ewart-James, V. (2016). Co-working spaces on the up. Thailand-Property <https://www.thailand-property.com/blog/co-working-spaces>.
- Foertsch, C. (2014). The coworking forecast 2014. Accessed on: <http://www.deskmag.com/en/the-coworking-market-report-forecast-2014>, 1. 10. 2015.
- Foertsch, C. (2017). First results of the 2017 Global Coworking Survey. <https://www.slideshare.net/carstenfoertsch/the-first-results-of-the-2017-global-coworking-survey>
- Fost, D. (2008). They're working on their own, just side by side. The New York Times <http://www.nytimes.com/2008/02/20/business/businessspecial2/20cowork.html>
- Gandini, A. (2015). The Rise of Coworking Spaces: A Literature Review. *Ephemera Journal*, 15(1), 193-205.
- JLL (2016). Shared workspaces: the market perspective. <http://www.us.jll.com/united-states/en-us/research/office/coworking-space-the-landlord-perspective>
- Maliszewska, Mattoo & Mensbrugghe (2020) The Potential Impact of COVID-19 on GDP and Trade. Policy Research Working Paper 9211, World Bank Group
- Olanrele, O. O., & Thontteh, E. (2020). COVID-19 and the 'New Normal': Implications for the Nigerian Real Estate Sector. University of Lagos (UNILAG) Centre of Housing Studies. Nigeria
- Oyedemi J. O. (2020). The impact of covid-19 on real estate transaction in Lagos, Nigeria. *International Journal of Real Estate Studies*, 14(1) 107-112
- Ozili K. P. (2020) COVID-19 pandemic and economic crisis: the Nigerian experience and structural causes Munich Personal RePEc Archive <https://mpra.ub.uni-muenchen.de/103131/>
- Ozili P., & Arun T. (2020) Spillover of COVID-19: impact on the global economy. SSRN Electronic Journal ·JEL classification: G21, G28, I11, I18
- Robelski, S., Keller, H., Harth, V., & Mache, S. (2019). Coworking spaces: The better home office? A psychosocial and health-related perspective on an emerging work environment. *International Journal of Environmental Research and Public Health*, 16, 1-22. DOI:10.3390/ijerph16132379
- Rooshdi, R. R. R. M., Majid, M. Z. A., Sahamir, S. R., & Ismail, N. A. A. (2018). Relative importance index of sustainable design and construction activities criteria for green highway. *Chemical Engineering Transactions*, 63, 151-156.
- Seo J., Lysiankova L., Ock Y., & Chun, D. (2017). Priorities of coworking space operation based on comparison of the hosts and users 'perspectives. *Sustainability*, 9, 1494-1504 DOI:10.3390/su9081494

- Spinuzzi, C. (2012). Working alone together: coworking as emergent collaborative activity. *Journal of Business and Technical Communication*, 26(4), 399-441.
- Spreitzer, G., Bacevice, P., & Garrett, L. (2015). Why People Thrive in Coworking Spaces. *Harvard Business Review Blog* <https://hbr.org/2015/05/why-people-thrive-in-coworking-spaces>
- Spinuzzi, C, Bodrožić, Z, Scaratti, G., & Ivakli S. (2019) Coworking is about community: but what is "community" in coworking? *Journal of Business and Technical Communication*, 33 (2) 112-140. ISSN 1050-6519
- Spinuzzi, C. (2012): Working alone together. *Journal of Business and Tehnical Communication*. 26(4): 3–35.
- Vanichvatana, S. (2017). Characteristics of Co-Working Spaces in Bangkok. Paper presented at the Second International Research conference on Management and Business (IRCMB), Bandung, Indonesia.
- Vanichvatana, S. (2018). Investigating Users 'Perspectives of Coworking Space: Cases of Bangkok CBD, In: Tipurić, Darko Labaš, Davor (Ed.): 6th International OFEL Conference on Governance, Management and Entrepreneurship. New Business Models and Institutional Entrepreneurs: Leading Disruptive Change. April 13th - 14th, 2018, Dubrovnik, Croatia, Governance Research and Development Centre (CIRU), Zagreb, 376-389
- Verschuur J, Koks E. E., & Hall J. W. (2021). Global economic impacts of COVID-19 lockdown measures stand out in high-frequency shipping data. *PLoS ONE* 16(4): e0248818.
- Yang E., & Bisson C. (2019) Coworking space as a third-fourth place: changing models of a hybrid space in corporate real estate. *Journal of Corporate Real Estate* 21(4) 324-345: DOI 10.1108/JCRE-12-2018-0051



---

## DESIGN TRENDS AND FUTURE PLANNING FOR INCLUSIVE DEVELOPMENT IN TROPICAL BUILT ENVIRONMENT

Asiah Abdul Rahim<sup>1</sup>, Nur Amirah Abd Samad<sup>2</sup> and Wan Mohamad Amin W Seman<sup>3</sup>

<sup>1</sup>*Department of Architecture/KAED Universal Design Unit (KUDU), Kulliyah of Architecture & Environmental Design, International Islamic University Malaysia.*

<sup>2</sup>*Department of Architecture, Faculty of Engineering & Built Environment, Universiti Kebangsaan Malaysia.*

<sup>3</sup>*KAED Universal Design Unit (KUDU), Kulliyah of Architecture & Environmental Design, International Islamic University Malaysia.*

A brief history of the introduction of Universal Design and Accessibility in Malaysia where it has been established since 1990 of three Malaysian Standards regarding design for access to buildings. Coping with the demands of providing accessibility for Persons with Disabilities (PwDs) and the elderly has been a challenge for these past three decades. The intention is to distinguish current Universal Design trends and the level of public and professional awareness of inclusive development. Furthermore, an exploration of integrating inclusive development within the tropical built environment and our social construct of Asian culture and lifestyle. As a summary, to cater design for diverse age and ability is esteemed in providing recommendations or innovation design solutions to accommodate access design that complements in creating an accessible built environment.

Keyword: accessibility, access design solution, inclusive development, universal design

### A BRIEF HISTORY OF UNIVERSAL DESIGN IN MALAYSIA

Essentially, the barrier-free concept was developed after World War II, when many troops returned from the war with disabilities such as amputation and hearing loss. As a result, rehabilitation centres that were deemed accessible for these injured soldiers were built. Furthermore, with the low mortality rate in Europe around that time, creating accessible facilities to accommodate their elderly population that were steadily increasing. Malaysia had just gained its independence when the prime minister at that time declared it in 1957 and initiated rebuilding the nation. The primary focus was on essential development for education, agriculture, economy and infrastructure. As the development was targeting the larger population, therefore, the erected buildings were not accessible. Gradually, urban

---

<sup>1</sup> arasiah@iium.edu.my

and rural development remained a government priority throughout the 1960s and 1970s.

Looking into global initiation of United Nations (UN) initiatives regarding Persons with Disabilities (PwDs) human rights movements, listed here are the chronology of the initiatives that lead to local context. Stein et al. (2008) listed the chronology that signifies the United Nation (UN) General Assembly's progress in the 1980s. The UN International Year of Disabled Persons in 1982, has constituted the International Decade of Disabled Person the following year of 1983 until 1992. Furthermore, the General Assembly in 1982, in efforts to encourage national-level programs to achieve equality, adopted a World Programme of Action Concerning Disabled Persons. Consequently, in 1993, the UN's Standard Rules on the Equalization of Opportunities for Persons with Disabilities was assimilated as a basic technical and economic alliance for policy-making with monitoring mechanism establishment.

American's with Disabilities Act (ADA) was conferred in 1990 as part of the International Decade for Disabled Persons from 1983 to 1992. As a result, it has become a globally recognised legal framework for protecting people with disabilities from discrimination in numerous domains of employment, access and equal opportunities (Kose, 2011; Manley, 1996). Emphasized by Kose (2011), the ADA movement accelerated the Japanese government to introduce some accessibility measures at the national level and find ways to integrate new trends toward accessibility into their policy initiatives by enacting the Japanese with Disability Act in 1993. As for in the United Kingdom (UK), coined by Clarkson et al. (2015), the incorporation of the Disability Discrimination Act (DDA) in 1995 as a rights-based legislative measure focuses on access to services in achieving social inclusion for PwDs.

Discernment in Asian countries has affected advocacy issues at Asia Pacific region under the United Nations Economic and Social Commission of Asia Pacific (UNESCAP) as highlighted by Nur Amirah et al. (2018) where several Asian countries, including Malaysia, have signed the Proclamation of the Asian and Pacific Decade of Disabled Persons for its first decade of 1993-2002. The second decade of 2003 until 2012, the UNCRPD and its Optional Protocol was embraced when developed in 2006. According to Tah et al. (2016), Malaysia has been committed to promoting and protecting the rights of PwDs, which is manifested by enacting the Persons with Disabilities Act in 2008. Following the acceptance of UNCRPD into the Malaysian legal framework, the government began formulating policies and implementing relevant measures to ensure compliance with UNCRPD rules.

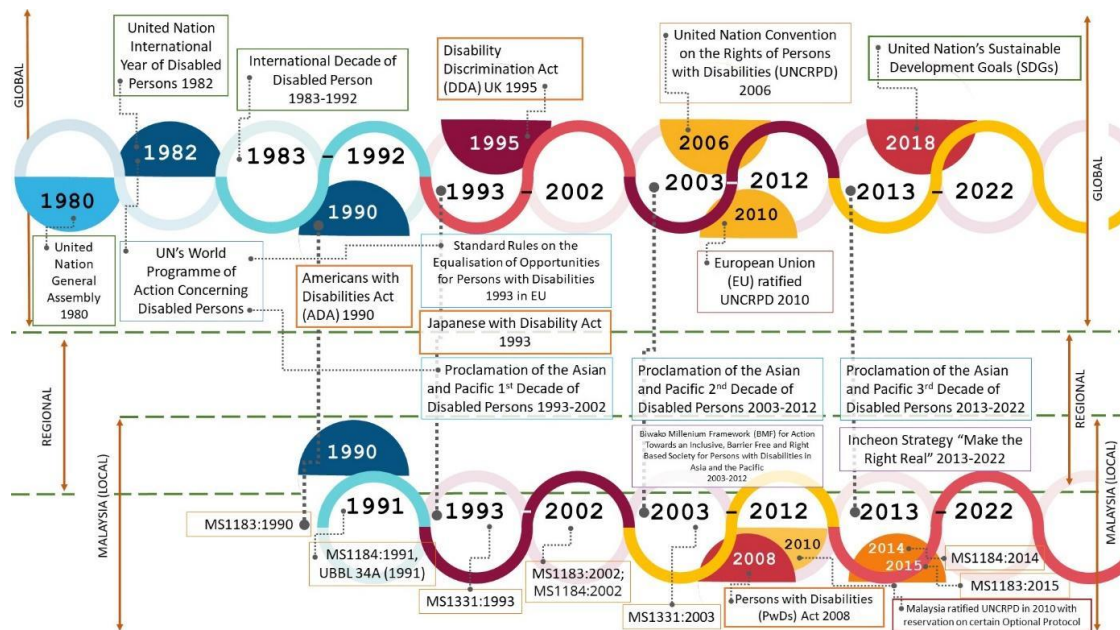

Figure 1 Cross-timeline of the United Nations initiation of international treaties on disability human rights leads to the establishment of legal disability legislative globally, regionally and locally in Malaysia. (Source: N. Amirah A.S., 2020)

## UNIVERSAL DESIGN TRENDS AND THE AWARENESS OF INCLUSIVE DEVELOPMENT

According to Harrison (2011), the UNESCAP Decade of the Disabled addressed the problems that many Asian faced between 1993 and 2002. Lack of access to buildings deprived people of their rights to education, work, and social or religious spaces. He stated that pilot projects were being explored in Bangkok, New Delhi, and Beijing, focusing on a 1km<sup>2</sup> region of the city and working with local officials, building owners, and other stakeholders having an interest in the area to propose ideas to enhance access in any manner feasible. BIWAKO Millennium Framework for Action Towards an Inclusive, Barrier-Free and Rights-Based Society for Persons with Disabilities in Asia and the Pacific, October 2002, is binding on Malaysia as a member of the United Nations Economic and Social Commission for Asia and the Pacific (UNESCAP).

It was established in 2008 by the KAED Universal Design Unit (KUDU), Kulliyah of Architecture & Environmental Design, International Islamic University Malaysia (IIUM) to conduct and provide training on accessibility audits for local authorities on various building typologies in Malaysia, including waterfront facilities, heritage buildings, markets, shopping malls, and transportation hubs. Only 25 percent of the case studies in this 2008 pilot study were deemed to be accessible. Collaboration with government agencies and local authorities led to the development of a module for access audits as a basis for evaluating the level of accessibility in built environments. Following this research, government agencies, local authorities, and nongovernmental organisations (NGOs) collaborated to build an access audits module to evaluate the level of accessibility in the built environment.

Societal attitudes towards PwDs have improved in recent years, but there is some hesitation among professionals in the construction industry and building owners. The reluctance to invest in PwDs facilities, probably for additional costing or the



mistaken beliefs of hampering the aesthetic quality for buildings to be more user-friendly. For instance, providing an accessible lift at a two or three-storey building will incur an unnecessary cost to small business. A ramp or handrails could disturb the appearance of a building façade or ruin the aesthetic appeal of a building. Design experts are becoming more aware of the need for buildings to be user-friendly, yet there are still areas of ignorance or reluctant acceptance when it comes to meeting merely the minimum needs of people with disabilities. Seemingly, the situation in Malaysia is presently at this phase, where in the UK happens in the 1990s, but for Malaysia, the current lack of public awareness for PwDs and their difficulties in accessing the built environment hence the oblivious attitude. Harrison et al. (2015) anticipate that attitudes towards disability may continue to improve, but there is no room for complacency. Even though western countries have been designing the accessible built environment, they still have to have a thorough commitment to ensuring the social sustainability of PwDs in inclusion and participation. Legislation to require accessibility is not the same as Universal Design but is a critical reinforcement to achieve an accessible built environment.

The UNESCAP have taken the initiatives to improve the quality of life of the PwDs, and governments have already started preparing the code of practice and standards for providing facilities. However, many ASEAN countries are not able to fulfil those requirements for many other reasons (Asiah et al., 2015). This shortcoming results from the inadequate comprehensive disability law that mandates non-discrimination principles in many other countries in Asia and the Pacific region (Perlin, 2012). Hence, the concerns also affect the enactment of non-discrimination laws in Malaysia.

## **INTEGRATION OF INCLUSIVE DEVELOPMENT IN ASIAN SOCIAL CONSTRUCT AND TROPICAL BUILT ENVIRONMENT**

A sustainable design for accessibility should be considered in all of our physical development in order to make our cities world class. Accessibility in the built environment is increasingly relevant to Malaysia, not only to prepare for the ageing population, PwDs but also the whole population at large. The statistics of PwDs registered under the Department of Social Welfare, Ministry of Women, Family and Community Development, Malaysia (DSM/JKM) on 31st December 2020 has a total of 588,159 people to date and will increase as more PwDs are to register. Nearly 80 percent of people with disabilities, according to this estimate, reside in developing nations. The UNCRPD was established to safeguard and expand the rights and opportunities of the world's estimated 650 million disabled persons. Most of countries, including Malaysia, have ratified the convention and agreed to adopt and enact laws to ensure that people with disabilities have equal access to education, employment, and cultural life; the right to own and inherit property; not be subjected to discrimination in marriage, children, etc.; and not be unwilling subjects in medical experiments.

PwDs, the elderly, as well as a wider variety of abilities or disabilities are the target users of accessible built environments, and numerous investigations have been conducted to determine the best techniques and approaches for creating and administering an accessible built environment. Based on user-centered design theory, inclusive design involves the successful collection of knowledge about the

end-user, which must be represented in a manner that can be accessed by the designer, according to Keates and Clarkson (2003). When the end-user information is translated into a concept, the designer must have the appropriate tools and methodologies at his disposal to test it against the end-needs user's and desires.

As Emory Baldwin also pointed out, too many homes are constructed for the "average" individual, despite the fact that very few people actually fit this description of "average". People come in a wide variety of sizes, shapes, and talents, and they go through a lot of changes in their lifetime. In his view, architects and designers prefer to create houses based on the client's appearance as it is now, and fail to take into account changes in the client's physical abilities and way of life over time. As a result, the requirements of any one individual should be properly met, but the needs of another individual should not be unduly compromised. Special attention should be focused especially on health and safety. In numerous cases, the usage of assistive devices by certain persons helps them to navigate the built world. Everyone's requirements should be considered while designing new surroundings. The layout and structure of an existing building or the external surroundings are likely to impose significant constraints.

Sustainability, according to Amer Hamzah M.Y. (2013), includes serving societal expectations in a way that can go on indefinitely without hurting or diminishing natural resources. The ability of future generations to satisfy their own desires without jeopardising current generations' ability to meet their own needs. We may say that universal design has anything to do with sustainability, which is defined as meeting all present and future requirements.

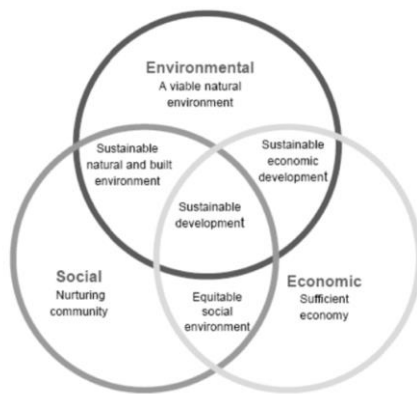

Figure 2: Cross Match of the Sustainable Solution. (Source: Amer Hamzah M.Y.,2013)

## FUTURE ANTICIPATION OF UNIVERSAL DESIGN FOR MALAYSIA

In addition, towns and governments began looking at codes to make their settings more accessible, as described by Harrison et al. (2015). Instead of relying on voluntary guidelines, notwithstanding the best intentions of the designers, clients and building owners are now required to include accessibility elements in all new projects. To that end, he noted that the Ron Mace's Seven Principles of Universal Design stipulated that facilities should aim to be usable 'to the greatest possible extent', rather than 'by all', acknowledging that there are limits to providing this inclusion to everyone in all situations. It is vital for designers to be aware of these

limits in order to create better and more integrated designs. In addition, learning more about how we design may help us expand our abilities and become more creative designers.

Comprehensive and integrated environment of barrier-free architecture is difficult to regulate as well as this is required by the law. The most crucial aspects of an accessible environment might not be connected at the interfaces due to they are given to various agencies and are regulated by different laws, which many faced major difficulty to handle. However, public buildings may be accessible and usable by a variety of disabled persons, whereas the road system is under another authority's jurisdiction with its own requirements. Simple narratives about a person going to the clinic will be subject to norms and limitations that vary considerably. The consequence of a well-thought-out design that considers all users equally at the outset rather than as an afterthought is clever, sensitive, engaging, and non-exclusive.

According to Kamarul Syahrul Kamal et al (2004), the more active approach to tropical architecture, however, attempts to harness certain climates elements for energy and increased efficiency. He recommended of the new design to meet the requirement of modern living according the following concepts;

- i. Roofs are frequently steeply pitched in order to assist water drainage and to offer a wide vented roof area below which heated air may disperse, keeping the building cold where gaps between wooden slats beneath the roof eaves might enable air to pass through.
- ii. Eaves with large overhangs are vital for shielding windows from the sun and rain, providing shade and reducing unwanted glare.
- iii. There are several ways to enhance natural ventilation, like leaving gaps between the overlapped roof eaves or cutting out flat patterns above the window.
- iv. Maximizing natural ventilation in a building is essential and can be accomplished by a variety of methods, like constructing a house on stilts so that wind speed rises with height or including holes in the walls of tall structures might help promote airflow.
- v. While wide windows and roof or wall air vents have a comparable effect, the designs must also keep rain from entering.
- vi. Orienting a particular building towards the direction of the prevailing wind is important where the airflow can be increased by arranging houses in random order as opposed to the regular patterns seen in most housing estates which trap air and prevent adequate ventilation.
- vii. Design wide open areas within the home and minimise the number of room barriers to stimulate air flow and cooling since the lack of internal walls results in improved cross ventilation. Choosing the right construction materials is also crucial in tropical architecture. In addition to being plentiful, local timber has a low thermal mass, which means that less heat is retained

and transferred into the structure. The heat is radiated into a structure via bricks, concrete, and glass.

Essentially, tropical architecture is based on the principle of adapting to and/or utilising the local tropical environment in order to enhance living circumstances for residents. Heat and rain are kept out, while natural ventilation and sunlight are encouraged. The passive response to tropical architecture has been practiced for centuries and is, today, slowly making a comeback in modern residential design. Therefore, the challenge continues until all problems can be mitigated in order to achieve the status of Inclusive City for Malaysian urban environments.

## REFERENCES

- Amer Hamzah Mohd. Yunos, (2013) Malaysia's green protocols initiatives, presentation of the 3rd international conference on universal design in the built environment 2013 (icudbe 2013).
- Asiah, A. R., Nur Amirah, A. S., & Che Raiskandar, C. R. (2015, 2nd -3rd March 2015). Overview of Universal Design Application and Accessibility in Major Cities of ASEAN Countries. 2nd International Conference on ASEAN Community 2015, Kuala Lumpur.
- Clarkson, J. P., & Coleman, R. (2015, 2015/01/01/). History of Inclusive Design in the UK. *Applied Ergonomics*, 46, 235-247.
- Harrison, (2011) international conference on universal design in the built environment 2011 proceeding 1, 3.
- Harrison, J., & Dalton, C. (2015). The Familiar and the Strange: The Limits of Universal Design in the European Context. *Journal of Universal Design in the Built Environment*, 1(1), 49-67.
- Kamal, K. S., A.Wahab, L., & Che Ahmad, A. (2004). Climatic Design of the traditional Malay House to Meet The Requirements of Modern Living. The 38th International Conference of Architectural Science Association ANZAScA 'Contexts of Architecture'. Launceston, Tasmania.
- Kose, s. (2013). Japanese struggle toward inclusive built environment: can it catch up with the speed of ageing and economic changes?, proceedings of the 3rd international conference on universal design in the built environment 2013 (icudbe 2013). ISBN: 978-983-3142-30-9.
- Kose, S. (2011). The Impact of Aging on Japanese Accessibility Standards In W. F. E. Preiser & K. H. Smith (Eds.), *Universal Design Handbook* (2nd ed.). McGraw-Hill Education.
- Manley, S. (1996). Walls of exclusion: The role of local authorities in creating barrier-free streets. *Landscape and Urban Planning*, 35, 137-152.
- Nur Amirah, A. S., Ismail, S., & Asiah, A. R. (2018). A Review of Universal Design and Accessibility Legislations in Implementation Strategies Among Asian Countries. In *Proceeding of The 12th SEATUC Symposium: Engineering Education and Research for Sustainable Development*. Yogyakarta, Indonesia.
- Perlin, M. (2012). Promoting Social Change in Asia and the Pacific: The Need for a Disability Rights Tribunal to Give Life to the UN Convention on the Rights of Persons with Disabilities. *SSRN Electronic Journal*.
- S. Keates, & J. Clarkson (2003) countering design exclusion. Bridging the gap between usability and accessibility. *Universal access in the information society* 2.

Stein, M., & Lord, J. E. (2008). Future Prospects for the United Nations Convention on the Rights of Persons with Disabilities. ARNADOTTIR, F3, 17-40.indd.

Tah, I. H. M., & Mokhtar, K. A. (2016). Malaysia's Ratification of the UN Convention on the Rights of Persons with Disabilities (UN CRPD). International Journal of Business, Economics and Law, Vol 11(Issue 4 (Dec)).

Retrieved from <http://www.archfoundation.org/2013/06/sustainable-visitible-and-universal-bydesign/#sthash.shgh4kza.dpuf>

Retrieved from [http://www.informedesign.org/\\_news/sustain01\\_06.pdf](http://www.informedesign.org/_news/sustain01_06.pdf)

Retrieved from World Health Organization report (2011).

UNCRPD. United nation convention on rights of persons with disabilities (2006). Article (2): definition - universal design and article (9): accessibility.



## DETERMINATION OF FACTORS THAT INFLUENCE LABOUR OUTPUT ON CONSTRUCTION SITES IN GHANA

Joseph Henry Acquah<sup>1</sup>, Humphrey Danso<sup>2</sup> and Emmanuel Bamfo-Agyei<sup>3</sup>

<sup>1</sup>*Works Department, Local Government Service, Ghana*

<sup>2</sup>*Department of Construction & Wood Technology, Akenten Appiah-Menka University of Skills Training and Entrepreneurial Development*

<sup>3</sup>*Department of Building Technology, Cape Coast Technical University.*

Labour output affects construction performance in most developing countries. This study aimed at determining the factors that influence labour output on construction sites in Ghana. The research design adopted for the study was a descriptive survey. The study focused on site-level operatives in active operation at their various construction sites. A sample size of 220 site-level operatives was considered. A questionnaire was used as data collection instrument. The study revealed that payment delay, inspection delay, rework, poor communication, unavailability of needed tools, lack of labour supervision and shortage of materials are the major factors that affect labour output in construction sites. The study concludes that labour output of construction workers in Ghana is affected by several factors. It is recommended that construction managers regularly inspect and pay attention to the quality of construction materials and tools used in projects to eliminate inspection delay and unavailability of needed tools.

Keywords: construction sites, inspection delay, labour output, payment delay, labour productivity

### INTRODUCTION

Construction is the biggest and most challenging sector in the world (Dorosh, 2020). The construction industry was expected to grow by 3.6% by 2020 before the eruption of the COVID-19 crisis, with revenue forecast at USD 15 trillion by 2024 (Global Powers of Construction [GPoC], 2020). In 2020, the estimate of growth in the construction industry fell to 0.5%, but the numbers vary across the regions. Emerging markets were projected to decline by 2% in 2020, before rebounding to 5% in 2021, while mature economies are expected to decline by 1.5% in 2020, followed by a 2% growth in 2021 (GPoC, 2020). Construction projects around the world have undergone significant costs and time overruns with low labor

---

<sup>1</sup> acqtechnical@gmail.com,

<sup>2</sup> hdanso@aamusted.edu.gh

<sup>3</sup> emmanuel.bamfo-agyei@cctu.edu.gh

production identified as a major reason for project delays and overruns of cost (Herrera, Sánchez, Castañeda & Porras, 2020).

Labour output has become a big problem in the construction industry in most developing countries, hence affecting construction performance (Adamu, Dzasu, Haruna & Balla, 2011). Ghana Statistical Service (2019), reported that the construction sub-sector recorded the least growth rate of -2.1% in the 2nd quarter of 2019 compared to 0.6% in the 1st quarter of 2019. Also, in the year 2020, the construction sub-sector grew by 0.9 percent in the 2nd quarter of 2020, compared to -1.7% in the 1st quarter of 2020 (Ghana Statistical Service, 2020). This means that Real Estate developers, institutions in the industry are in a great challenge of growth within the industry sector, of which the cost of plants, labour, and materials are not exceptional. Labour output is one of the greatest threats in construction projects in Ghana. Many of the building construction work in Ghana still rely heavily on manual labour in their assembly (Bamfo-Agyei, Thwala & Aigbavboa, 2020). Ghana Statistical Service (2018) report revealed that the construction industry employs over 600,000 workers, amounting to about 7% of the working population in Ghana who are required to deliver the constructed facilities to the clients on time, within budget, and meeting the specified standards of quality. Consequently, there is a growing and continuous interest in productivity studies all over the world because of the importance of labour output in the management and control of project costs (Attar, Gupta & Desai, 2012).

Productivity remains an intriguing subject and a dominant issue in the construction sector, promising cost savings and efficient usage of resources (Enshassi et al., 2007). Present construction contracts are not capable to recovery for productivity loss due to field factors (Construction Industry Institute (CII), 2000). With all the project-cost components such as labours, materials, and equipment; labour component is considered the riskiest. Whereas other components (equipment and material) are determined by the market price, and prices are consequently beyond the influence of project management. Labour cost in the construction industry is estimated to be about 33- 50% of the entire project cost (Hanna et al., 2008). Jarkas and Bitar (2012) and Jarkas et al. (2012) pointed out that, labour cost, in most countries, comprises 30-50% of overall project. Because labour is more variable and unpredictable than other project-cost components, it becomes necessary to understand the effects of different factors on labour productivity. An increase in labour productivity can reduce the labour cost in a direct proportion. It can either benefit or reduce a project's profit, making it of vital interest to the construction industry for its success (Hanna et al., 2008).

Identifying the factors that affect the labour output on construction site is important to the performance of the construction industry. There is therefore the need to determine the factors that affect labour output on construction sites, especially in developing countries context (Adamu, Dzasu, Haruna & Balla, 2011).

In response to this, the current study aims at determining the factors that influence labour output on construction sites in Ghana.

## **LITERATURE REVIEW**

Labour is one of the basic requirements in the construction industry. Labour output usually relates manpower in terms of labour cost to the number of outputs produced (Borcherding & Liou, 1986). Labour is a task that requires the exertion of body or mind or both. It is regarded as an important resource in construction because it is the one that combines all the other resources namely materials, plant equipment, and finance to produce the various construction products as expressed by Fagbenle (2011). This then leaves labour as the major resource opened to improvement. The construction sector is a strategic part of every society, it is one of the largest employers and attracts a large amount of investment (both public and private) while being responsible for providing the necessary infrastructure to nations. Construction employs more than 7% of Europe's workforce and is the largest industrial employer in the continent (Proverbs et al., 1999). Building construction, in particular, consumes approximately 70% of construction investment in developing countries (World Bank, 2015). The battle to complete construction projects on time and within budget is ongoing, being fought when faced with low labour output. Aynur et al. (2008) noted that construction labour accounted for the largest percentage of total project costs in developing countries (i.e., as much as 40% of direct capital cost in large construction projects).

Despite the new technology builders have access to, the excess of construction material, the equipment and financing available, contractors were still faced with rising construction costs, longer project timelines, and cost overruns (Jarkas & Bitar, 2012). Much of the leakage had occurred in labour, where weak output had eroded investments made by contractors. The level of labour output in a country and the construction industry in particular may be determined by a number of factors. According to Attar et al. (2012), the identification and evaluation of factors affecting construction labour output have long been critical issues facing project managers with respect to increasing productivity in construction. Understanding the critical factors that both positively and negatively affect productivity has been posited to be necessary for the enhancement of construction labour productivity and project performance (Enshassi et al., 2007; Attar et al., 2012). Reflecting this perspective, Jergeas (2009) reported that there are undue cost overruns, delays and losses of productivity associated with the delivery of major capital construction projects everywhere in the world. Jergeas's study found that researchers and practitioners have identified poor management practices that lead to poor performance, such as scope changes, design errors and omissions, lack of proper planning and scheduling and improper management of tools, equipment, materials and labour, among many other factors. Several insights and recommendations have been



proposed which are yet to be implemented in a manner that will result into tangible productivity and expected project performance (Jergeas, 2009).

Attar et al. (2012) noted ineffective management to be a primary cause of low productivity and identified a lack of alignment among goals, contractual conflicts, difficulties in measuring productivity, weak commitments to continuous improvement and a lack of labour force focus as barriers to improving productivity. Enshassi et al. (2007) observed that, despite having been intensive investigations made into factors affecting labour output, researchers have not agreed on a universal set of factors with significant influence on productivity nor has any agreement been reached on the classification of these factors. Those authors, however, grouped factors affecting construction labour output into 10 categories: manpower, leadership, motivation, time, materials/tools, supervision, project, safety, quality and external factors. Kazaz et al. (2008) considered labour output factors under four groups – organisational factors, economic factors, physical factors and socio-psychological factors – deriving these four from the theory of motivation.

Adamu et al. (2011) identified 10 labour output-influencing factors among operatives in indigenous construction organisations in the north-eastern states of Nigeria: the absenteeism of gang members, instruction delays, supervisory incompetence, lack of materials, low wage levels, an unfriendly working atmosphere, repetitious work, a lack of proper tools, interference between operatives, changing crew members and inspection delays. The study found that low wages, a lack of materials and an unfriendly working atmosphere most affected labour output. Durdyev and Mbachu (2011) researched key constraints and improvement measures for on-site labour output using 56 sub-factors. The factors were identified under eight broad categories of internal and external constraints: project management/project team characteristics, project finance, workforce, labour-related factors, unforeseen events, technology/process, statutory compliance and other external factors.

Attar et al. (2012) identified factors affecting construction labour output under 15 categories: design factors, execution plan factors, material factors, equipment factors, labour factors, health and safety factors, supervision factors, working time factors, project factors, quality factors, financial factors, leadership and coordination factors, organisation factors, owner/consultant factors and external factors. The study further recognised some of these factors as being among the top ten to affect the labour productivity of small and medium-sized companies, large companies and all companies in general and it was observed that labour-related factors cut across all groups. Although labour-related factors featured prominently among those factors identified as affecting construction labour output, none of these studies considered their influence on construction labour productivity across geographical demarcations by comparing the views of building

craftsmen and site supervisors – important project team members who are directly involved with construction labour productivity matters. Fagbenle (2009) identified three main factors that are affecting site performance as: shortcomings in labour management (unfair wages, lack of motivation etc.); extraneous reasons (harsh weather, breakdown of law and order etc.); and labour’s shortcoming (lateness, idleness, poor workmanship etc.). Fagbenle (2009) grouped the factors affecting the environment of construction projects under cultural, economic, political, social, physical, aesthetic, financial, legal, institutional, technological and policy. Other influencing factors identified include traditional measures such as health, safety, material, size and scope (Fagbenle, 2011).

## METHODOLOGY

The research design adopted for the study was a descriptive survey. Considering the nature of the study, the descriptive survey design was deemed appropriate in terms of collecting data from a large group of respondents within a relatively short period. The study population includes site-level operatives of some selected construction sites in the Metropolitans and Municipalities of the Central and Western regions of Ghana. These groups of site operatives were considered for the research as they were considered to have a large proportion of their labour force engaged on sites.

Purposive sampling was employed in selecting all the construction site level operators for the study because of the activities required to be studied. The study focused on site-level operatives in active operation during the period of the study. Since it is not economical to consider the entire population due to time and other logistic reasons, a sample size of 220 site level operatives consisting from Cape Coast Metropolis, Mfanteman Municipality, Awutu Senya East Municipality, and Sekondi-Takoradi Metropolis. For data collection and analysis, a questionnaire was employed as a data collection instrument.

A questionnaire was used to collect data that was not directly observable from the participants about their characteristics, experiences and opinions. Closed-ended questions were used for the reason that they are easy to ask and quick to answer, they require no writing by either respondent, and their analysis is straightforward. 5-Point Likert scale response was used. Analysis was undertaken to generate a descriptive picture of the data gathered through a questionnaire. In this study, Statistical Package for Social Sciences (SPSS) version 23.0 was used in analysing the data. The contribution of each of the variables was examined and the ranking of the attributes in terms of their criticality as perceived by the respondents was done by the use of Relative Importance Index (RII) which was computed using equation (1):

$$RII = \frac{\sum W}{A * N} (0 \leq RII \leq 1) \dots \dots \dots (1)$$

Where:

W – is the weight given to each factor by the respondents and ranges from 1 to 5, (where “1” is “strongly disagree” and “5” is “strongly agree”);

A – is the highest weight (5 in this case) and;

N – is the total number of respondents.

## RESULTS AND DISCUSSION

### Factors that affects labour output in construction sites

**Table 1: Responses on factors that affect labour output in construction sites**

Factors affecting labour output	Responses (Ranking)					ΣW	Mean (ΣW/N)	RII	RANK
	1	2	3	4	5				
Payment delay	6	19	11	105	42	706	3.86	0.772	1 <sup>st</sup>
Inspection delay by managers	11	17	14	103	38	690	3.77	0.754	2 <sup>nd</sup>
Rework	8	30	7	97	41	682	3.73	0.745	3 <sup>rd</sup>
Poor communication between managers & labourers	13	26	8	98	38	672	3.67	0.734	4 <sup>th</sup>
Unavailability of needed tools	3	38	18	97	27	655	3.58	0.716	5 <sup>th</sup>
Lack of labour supervision	10	27	24	97	25	650	3.55	0.710	6 <sup>th</sup>
Shortage of materials	10	35	13	97	28	648	3.54	0.708	7 <sup>th</sup>
Accidents during construction	6	33	31	99	14	631	3.45	0.674	8 <sup>th</sup>
Personal problems of labour	18	29	13	99	24	631	3.45	0.670	9 <sup>th</sup>
Lack of skills of labour	14	44	13	85	27	617	3.37	0.670	9 <sup>th</sup>
Labour dissatisfaction	14	43	12	96	18	609	3.33	0.666	11 <sup>th</sup>
Unsuitability of storage	14	44	16	86	23	609	3.33	0.666	11 <sup>th</sup>
Poor health of labour	8	56	10	89	20	606	3.31	0.662	13 <sup>th</sup>
Misunderstanding of laborers	12	65	19	73	14	562	3.07	0.614	14 <sup>th</sup>
Working overtime	16	62	15	74	16	562	3.07	0.614	15 <sup>th</sup>
Labour absenteeism	18	68	15	68	14	542	2.96	0.592	16 <sup>th</sup>
Site restricted access	42	53	7	61	20	512	2.80	0.559	17 <sup>th</sup>
Physical fatigue	19	84	12	55	13	509	2.78	0.556	18 <sup>th</sup>
Raining	30	69	28	43	13	489	2.67	0.534	19 <sup>th</sup>
Unsuitability rest area on site	24	91	23	38	7	461	2.52	0.504	20 <sup>th</sup>
Delay in responding to requests	29	84	25	37	8	459	2.51	0.502	21 <sup>st</sup>
Power outage	29	90	17	42	5	454	2.48	0.496	22 <sup>nd</sup>
Inadequate coordination	31	84	30	32	6	446	2.44	0.487	23 <sup>rd</sup>
Stringent inspection	33	88	29	26	7	435	2.38	0.475	24 <sup>th</sup>
Variation orders	40	86	25	25	7	423	2.31	0.462	25 <sup>th</sup>
Site layout problems	37	92	24	25	5	417	2.28	0.456	26 <sup>th</sup>
Design complexity level	35	99	23	20	6	412	2.25	0.450	27 <sup>th</sup>
Unclear specifications	45	90	15	28	5	406	2.22	0.443	28 <sup>th</sup>
Labour disloyalty	35	108	19	17	4	395	2.16	0.431	29 <sup>th</sup>
Alcoholism and drug abuse of labours	37	105	19	19	3	395	2.16	0.431	30 <sup>th</sup>
Lack of competition between the Laborers	52	83	17	30	1	393	2.15	0.429	31 <sup>st</sup>
Inadequate transportation for labours	39	104	17	20	3	393	2.15	0.429	32 <sup>nd</sup>
Confinement of working space	42	101	17	19	4	392	2.14	0.428	33 <sup>rd</sup>
Implementation of government laws	48	98	18	18	1	375	2.05	0.410	34 <sup>th</sup>
Shortage of experienced labour	58	87	17	19	2	370	2.02	0.404	35 <sup>th</sup>
High Temperature	58	96	17	11	1	349	1.91	0.381	36 <sup>th</sup>

Table 1 shows the Relative Importance Indices (RII) and the rankings of the factors that affect labour output in construction sites. As indicated in Table 1, thirty-six (36) factors were identified by respondents to affect labour output in construction sites.

As depicted in Table 1, seven items were identified as the main factors that affect labour output in construction sites with  $RII \geq 0.7$  and mean values  $\geq 3.5$ . These factors in the order of ranking are payment delay, inspection delay by managers, rework, poor communication between managers and labourers, unavailability of needed tools, lack of labour supervision and shortage of materials.

The finding concurs with the study by Attar et al. (2012) noted that unavailability of suitable tools, payment delay, inspection delay, and ineffective management to be a primary cause of low productivity and identified a lack of alignment among goals, contractual conflicts, difficulties in measuring productivity, weak commitments to continuous improvement and a lack of labour force focus as barriers to improving productivity. Reflecting this perspective, Jergeas (2009) reported that there are undue cost overruns, delays and losses of productivity associated with the delivery of major capital construction projects everywhere in the world due to factors such as payment delay, lack of labour supervision, inspection delay, and shortage of materials. Jergeas's study found that researchers and practitioners have identified poor management practices that lead to poor performance, such as scope changes, design errors and omissions, lack of proper planning and scheduling and improper management of tools, equipment, materials and labour, among many other factors.

The view of the construction workers that payment delay affects labour output in construction sites supports the study by Lema (1995), who mentioned that non-financial benefits such as transport, meals, and uniforms have a high effect on labour productivity. Christian and Hachey (1995) indicated that payment delays in the construction industry are adversarial and disastrous.

Late payment affects a company's cash flow and may ultimately lead to a business's failure. Timeliness of payment is important to avoid the risk of the late-payment problem. A study by Zou et al., (2007) pointed out that project-funding problems have been identified as cost-related risks, time-related risks, and quality-related risks which can significantly influence the delivery of a construction project. The risk of delayed payment from the owner impacts the duration and cost of the project. These risks cause the project's cost to increase abnormally and, subsequently, delay the project's progress.

The agreement of the construction workers on inspection delay by site management as a factor that affects labour output aligns with the past studies (Guhathakurta and Yates, 1993; Olomolaiye et al., 1996) that inspection delay negatively affects labour output. Olomolaiye et al., (1996), mentioned that inspection delays are an important process; for example, because contractors cannot cast concrete before inspection of formwork and steelwork, the inspection delay contributes to delays in work activities. It completely stops the task that requires the presence of supervisors, such as casting concrete and backfilling. Additionally, it delays the inspection of completed work which, in turn, leads to a delay in the commencement of new work. According to the study by Fugar and

Agyakwah-Baah (2010) in Ghana, the inability of clients (building owners) to honour payments on time was determined as the first major factor that causes delays in building construction projects in Ghana. Makulsawatudom et al. (2004) on the same issue pinpoint the labour output on-site might be affected negatively by inspection delay by site managers.

The site operative's agreement that rework affects labour output in construction sites agreed with a similar study by Frimpong et al. (2003), who found that reworks are the main factors that cause delay in the construction of projects in Ghana. Alaghbari et al. (2007) study in Malaysia indicated that from a list of thirty-one (31) factors, clients, contractors and consultants agreed that rework were the main factors causing delay. Sweis et al. (2008) studied the causes of delay in residential projects in Jordan and concluded that financial difficulties faced by the contractor and rework orders by the owner are the leading causes of construction delay. Abd El-Razek et al. (2008) in a similar study in Egypt found that the most important cause of delay is rework by contractors during construction projects.

Communication problems identified by the construction workers as a factor that affects labour output buttress with the finding of Hickson and Ellis (2014) that poor communication affects labour output. Hickson and Ellis pinpoint that relaying information from management to labour and vice versa is challenging for both parties but it is essential on the job site. Communication was rated 7th in the productivity categories in Jiukun et al., (2009), 6th in the Makulsawatudom and Emsley (2003) list of critical factors, and 6th in Henry et al., (2007). Inaccurate or ambiguous instruction has been identified as a particular concern for labourers. Fagbenle et al., (2011) indicated that communication affects labour productivity. Fagbenle indicated that for construction labours to be effective, they must clearly understand what is required to be done on site. Communication within organizations is a vital ingredient of motivation. For example, employees are likely to be motivated by recognition and constructive feedback from their line manager.

The agreement that unavailability of suitable tools is the factor that affects labour output supports the study by Paulson (2015), who found that the unavailability of suitable tools affects labour productivity. This result is also supported by Heizer and Render (1990), who confirmed that unavailability of suitable tools on sites affects job site productivity. The finding also concurs with the study by Makulsawatudom and Emsley (2003) who found unavailability of suitable tools as the 2nd factor that affects labour output and the 2nd most important productivity category in Jiukun et al., (2009). Unavailability of suitable tools is due to delinquent project management or as a result of economic constraints on the contractor, this problem could be solved with better planning.

## **CONCLUSION**

Labour output is one of the main determinants of the success of any construction project. The study aimed at determining the factors that influence labour output on construction sites in Ghana. Seven factors were identified as the major factors that affect labour output in construction sites in Ghana. These are payment delay, inspection delay, rework, poor communication, unavailability of needed tools, lack of labour supervision and shortage of materials. The study concludes that labour

output of construction workers in Ghana is affected by several factors. It is recommended that construction managers regularly inspect and pay attention to the quality of construction materials and tools used in projects to eliminate inspection delay and unavailability of needed tools. Regular inspection and use of appropriate materials and tools will reduce both the time taken to finish the work and the wastage of materials.

## REFERENCES

- Adamu, J. R., Dzasu, D., Haruna, C., & Balla, S. E. (2011). Innovation in the building sector: Trends and new technologies, IPENZ Convention, Conference paper No. 95, 34-53.
- Attar, A. A., Gupta, A. K., & Desai, D. B. (2012). A study of various factors affecting labour productivity and methods to improve it. *IOSR Journal of Mechanical and Civil Engineering (IOSR-JMCE)*, 1(3): 11–14.
- Aynur, K., Manisali, E., & Ulubeyli, S. (2008). Effect of basic motivational factors on construction workforce productivity in Turkey. *Journal of Civil Engineering and Management*, 14(4), 95-106
- B.S.3138 (1992). A Glossary of Terms Used in Work Study and Organization and Management. The British Standards Institute, Pp 21-22.
- Bamfo-Agyei, E., Thwala, W. & Aigbavboa, C. (2020). Influence of workforce on productivity of labour intensive works on feeder road construction in Ghana. Research Gate publication, 6, 91- 104.
- Construction Industry Institute. (2000). Work force view of construction labor productivity (RR215-11). Austin, Texas: Construction Industry Institute.
- Creswell, J. W. (2009). Educational research: Planning, conducting and evaluating quantitative and qualitative research (4thed.). Boston: Pearson Education, Inc.
- Dorosh, K. (2020). The Construction Industry's Top 5 Challenges. Retrieved from <https://www.chiefarchitect.com/blog/business-challenges>. Accessed: March, 20, 2021
- Dupont, Q., Chua, D., Tashrif, A., & Abbott, E. (2017). Potential Applications of UAV along the Construction's Value Chain. *Procedia Engineering*, 182, pp.165-173.
- Durdyev, S., & Mbachu, J. (2011). On-site Labour Productivity of New Zealand Construction Industry: Key Constraints and Improvement Measures. *Australasian Journal of Construction Economics and Building*, 11, 3, 18-33.
- Enshassi, A., Mohamed, S., Mayer, P., & Abed, K. (2007). Benchmarking masonry labor productivity, *International Journal of Productivity and Performance Management*, 56 (4), pp. 358-368.
- Fagbenle, O. I. (2011). Factors affecting the performance of labour in Nigerian construction sites. *Mediterranean Centre of Social and Educational Research Journal*, 2, 2, 251-257.
- Fagbenle, O. I. (2009). The Effect of Non-Monetary Incentives on the Performance of Construction Craftsmen in Nigeria. The Construction and Building Research Conference of the Royal Institution of Chartered Surveyors (COBRA), held at the University of Cape Town, 12 Great George Street, London, United Kingdom, 737 – 753
- Ghana Statistical Service (2018). Labour force Report. Ghana Statistical Service; Accra, Ghana.

- Ghana Statistical Service (GSS) (2019). Newsletter Quarterly Gross Domestic Product (QGDP) Second Quarter. Retrieved from <https://www.statsghana.gov.gh/gssmain>. Accessed: March, 20, 2021.
- Ghana Statistical Service (GSS) (2020). Newsletter Quarterly Gross Domestic Product (QGDP) Second Quarter. Retrieved from <https://www.statsghana.gov.gh/gssmain>. Accessed: March, 20, 2021.
- Gheisari M., Irizarry J., & Walker, B. (2014). UAS4SAFETY. The Potential of Unmanned Aerial Systems for Construction Safety Applications. Construction Research Congress American Society of Civil Engineers, 10 (15), 1801-1810
- Gheisari, M., & Walker B. N. (2012). Usability Assessment of Drone Technology as Safety Inspection Tools Journal of Information Technology in Construction, 17 (12), pp. 194-212
- Ghoddousi, P., Poorafshar, O., Chileshe, N., & Hosseini, M. R. (2015). Labour productivity in Iranian construction projects: Perceptions of chief executive officers. International Journal of Productivity and Performance Management, 64(6), 811-830.
- Global Powers of Construction (GPoC) (2020). Outlook of the construction industry worldwide. Madrid: Marketing & Brand Department, 4-56.
- Hanna, A. S., Chang, C., Sullivan, K. T., & Lackney, J.A. (2008). Impact of shift work on labour productivity for labour intensive contractor. Journal of Construction Engineering and Management, 138(3): 197–204
- Harris, F., & McCaffer, R. (2001). Modern Construction Management (5th ed). London: Blackwell Publishing
- Herrera, F. R., Sánchez, O., Castañeda, K., & Porras, H. (2020). Cost Overrun Causative Factors in Road Infrastructure Projects: A Frequency and Importance Analysis. Applied science review, 10, 1-25.
- Honig, Z. (2011) "T-Hawk UAV enters Fukushima danger zone, returns with video." 6:48PM April 21, 2011, retrieved on April 22, 2011. <http://www.engadget.com/2011/04/21/t-hawk-uav-enters-fukushima-danger-zonereturns-with-video>
- Irizarry, J., Gheisari, M., & Walker, B. (2012) Usability Assessment of Drone Technology as Safety Inspection Tools. ITcon, 17, page 194-212
- Jarkas, A., Kadri, C., & Younes J. (2012). A survey of factors influencing the productivity of construction operatives in the state of Qatar. International Journal of Construction Management, 12(1), 23.
- Jergeas, G. (2009). Improving construction productivity on Alberta oil and gas capital projects," Alberta Finance and Enterprise, University of Calgary, Alberta, Canada.
- Kisi, K. P., Mani, N., & Rojas, E. M. (2014). Estimating optimal labor productivity: A two-prong strategy. Proceeding Construction Research Congress, ASCE, Georgia, 757-766.
- Lodico, M, Spaulding, D., & Voegtler, K. (2006). Methods in educational research: From theory to practice. San Francisco, CA: John Wiley and Sons.
- Morgenthal, G., & Hallermann N. (2014). Quality Assessment of Unmanned Aerial Vehicle (UAV) Based Visual Inspection of Structures. Weimar Institute of Structural Engineering.
- Nisser, T., & Westin, C. (2006). Human factors challenges in unmanned aerial vehicles (uavs): A literature review. School of Aviation of the Lund University, Ljungbyhed.

- Proverbs, D. G., Holt, G. D., & Olomolaiya, P. O. (1999). Construction resource/method factors influencing productivity for high rise concrete construction. *Journal of Construction Management and Economics*, 17(5), 577-587
- Shuaibu, A. (2010). Determination of Labour outputs for roof carcassing, roof covering and painting in the Nigeria construction industry, Unpublished B.Sc. thesis, Department of Quantity Surveying, Ahmadu Bello University, Zaria, Nigeria
- Song, R., & AbouRizk, J. E. (2008). Construction labour productivity modeling with neural networks. *Journals of Construction Engineering and Management*, 124(6), 498-504.
- Thomas, R. H. (1994). Effects of scheduled overtime on labour productivity. *Journal of Construction Engineering and Management*, 118. 1, 60-70.
- Torok, M. (2014). *Image- Based Automated 3D Crack Detection for Post- Disaster Building Assessment*. Reston. ASCE.
- Udegbe, M. I. (2007). Labour Productivity Activity in the Nigeria Construction industry in Edo State, *Nigeria Journal of Social Science*, 14(2), 179-184
- World Bank (2015). *Two years of Intifada, closures and Palestinian economic crisis*. Washington, USA





## DEVELOPING A FRAMEWORK FOR PUBLIC PRIVATE PARTNERSHIP PROJECT GOVERNANCE IN NIGERIA

Atoyebi Kayode Emmanuel<sup>1</sup> and Ojo Stephen Okunlola<sup>2</sup>

<sup>1,2</sup>*Department of Building, Obafemi Awolowo University Ile-Ife, Nigeria*

The widening gap in infrastructural deficit especially in the developing world has forced governments to explore innovative financing methods where private sector investments are attracted through a mutually beneficial arrangement called Public Private Partnership (PPP). However, PPPs are not solutions to all infrastructural problems due to variation in project type and settings. Despite the various benefits of application of PPP in project management, there has not been a unified structure/framework for successful implementation of PPP arrangement in project governance in Nigeria. This study therefore attempts to develop a framework for implementing PPP projects with a view to enhancing the service delivery performance of PPP in project governance in Nigeria. Conceptually, the studied reviewed critical factors affecting PPP in project governance, project governance, Critical Success Criteria (CSCs) and Critical Success Factors (CSFs) for PPP in project governance. Using examples from both developed and developing world, the study established the inter-connectivity between elements of PPP structure, Critical Success Factors (CSFs) and Critical Success Factors (CSFs) in the development of the framework to enhance service delivery performance of PPP in Project Governance in Nigeria. It was concluded that the success of PPP project governance in Nigeria fundamentally depends on the adoption of an integrated framework.

Keywords: framework, governance, infrastructure, Nigeria, public private partnership

### INTRODUCTION

All over the world, project governance is adjudged to characteristically provide the best indication of who is involved in the project; and who in the project organisation is responsible for any course of action through its life cycle (Ekung, Agu1 & Iheama, 2017). In a broader sense, it is defined as the set of policies, regulations, functions, processes, and procedures and responsibilities that define the establishment, management and control of projects, programmes or portfolios (APM, 2012). The term project governance has attracted research attention considerably in the construction industry and many institutions and industries have also applied the term to suit their application (Bekker & Steyn, 2008). However, the overriding application in the context of the construction project is centred on three

<sup>1</sup> emanlin004@gmail.com Tel: +234 806 535 1588

<sup>2</sup> stephenajo79@gmail.com

basic variables: organization, management, and policies framework (Patel & Robinson, 2010). In mega project delivery, project governance involves the coordination, management and prompting the distribution of resources to achieve targeted goal of infrastructure development (Patel & Robinson, 2010).

As established by World Bank (2015), the success of any project does not occur accidentally, rather, it occur as a result of careful conceptualization, design, implementation and factoring of all the variables which may influence the success of a project in a given locality. Studies revealed that determining project success varies with every project perspectives and there is no established framework or specific criterion for judging construction project success (Davies, Crawford & Lechler, 2009). Project success is traditionally assessed based on three major criteria namely: time; cost and quality (Khosravi & Afshari 2011). These success criteria are what Atkinson (1999) referred to as the "iron triangle". However the challenges associated with the management of projects has forced government to explore new and innovative financing methods in which private sector investment can be attracted to provision of infrastructure through a mutually beneficial arrangement called Public Private Partnership (Adhazi & Bowles 2001; 2001a; 2001b).

According to Koppenjan (2005) and Liu et al (2016), public-private partnership (PPP) is an innovative procurement approach in which public and private actors cooperate to develop infrastructure and deliver public services, sharing the risks, costs and benefits. The goal of public private partnership (PPP) is to bring every project to successful service delivery and operation that would maximally deliver its sets goals. The adoption of PPP has created a room to address numerous challenges associated with traditional procurement method and to ensure that the socio-economic values of public projects are captured effectively with the aim to combine the skills, expertise, and experience of both sectors to deliver higher standard of services to citizens (Koppenjan, 2005). As a particular type of collaborative governance, PPP governance is about steering the decision and action processes in the private, public, and civic sectors (O'Leary, Gerard, & Bingham, 2006).

In recent times, the public-private partnership (PPP) concept has gained considerable attention among governments in both developed and developing countries (Cheung et al., 2012) due to its numerous benefits for successful project delivery. However, despite the enthusiasm from the public and private sectors, there has been slow progress in the implementation of the PPP policy as well as an increased number of failed or distressed projects particularly in developing countries (World Bank 2015a; Osei-Kyei, 2015, Chan, Javen & Ameyaw, 2016). Also, due to challenges inherent in the implementation and the vague knowledge of many PPP model or projects, the question on the successful delivery of its objectives and benefits remains a daunting task.

In Nigeria, evidences have shown that PPP has been adopted in a wide range of sectors for infrastructure service delivery across the nation and suitable for all types of infrastructural projects (Babatunde, Opawole and Akinsiku, 2012; Gbadegesin & Aluko, 2014). However, Cheung et al. (2012) cautioned that PPPs are not a cure for all problems and not suitable for all project settings. Diverse range of PPP forms have been implemented with success and some with failures depending on the

objective(s) of the project due to numerous factors across each locality (Zhang, 2005). Many experts in the industry are aware of the effectiveness and benefits of PPP but are unable to determine how best to achieve maximum success and goals optimally (Agyemang, 2011; Cheung, Chan & Kajewski 2009). These pose a serious challenge to the realization that partnership arrangement such as PPP are particularly good vehicle for bringing about project objectives and the definite objectives of achieving the goals of PPP synergy vary among stakeholders.

The success of PPP projects has become inevitable as there has not been a unified structure/framework for the successful implementation of PPP arrangement in project governance. Assessing the success of PPP in projects governance requires in-depth variables relative to the uniqueness and nature of PPP projects. This study therefore develops a framework for implementing PPP projects with a view to enhancing the service delivery performance of PPP in project governance in Nigeria. Conceptually, the studied reviewed crucial underlying factors such as PPP, project governance, Critical Success Criteria (CSCs) for PPP in project governance, Critical Success Factors (CSFs) for PPP in project governance and the factors affecting PPP in project governance in Nigeria.

## **LITERATURE REVIEW**

This review of literature encompasses the concepts and models relevant for the development of a framework for public private partnership project governance with consideration for the Nigerian experience. The study reviewed the concept of PPP, project governance. It highlighted and extracted components of the concession model (user pays) and the UK Private Finance Initiative (public sector pays) to allocate responsibilities and risks between the public and private partners in different ways in Nigeria. It further analysed PPP Experience and Project Governance in Nigeria. Using the structure of the elements of Critical success criteria (CSC) for PPP projects and Critical success factors (CSFs) for PPP projects, the paper developed a framework to enhance service delivery performance of PPP in project governance.

### **The concept of Public Private Partnership**

PPPs are the long-term contractual relationships formed between public sectors and private entities, aiming to procure and provide public assets and relevant services through the use of private sectors 'resources and expertise (European Investment Bank [EIB], 2004). In another parlance, it also refers to as long-term participation between government and the private sector for the provision of infrastructure and public services (Bovaird, 2004; Harris, 2004). Van Ham & Koppenjan (2001) also defined PPP as a cooperation of some sort of durability between public and private actors in that they jointly develop products and services and share risks, costs and resources that are connected with these products. The defining features of PPPs, compared with other forms of private participation in infrastructure, include risk transfer, long-term contract relationships, and partnership agreements (Li & Akintoye 2003).

PPP is an innovative procurement approach in which public and private actors cooperate to develop infrastructure and deliver public services, sharing the risks, costs, and benefits (Koppenjan, 2005). This implies that a public-private partnership

is a contractual arrangement between a public agency and a private sector entity and through the agreement, the skills and assets of each sector are shared in delivering a service or facility for the use of the general public. It is a means of utilizing the private sector resources in a way that is a combination of outsourcing and privatization with government partnerships. This because nations are increasingly relying on creative financing and asset management to maintain and improve infrastructure because PPP provides a more efficient and cost-effective means of providing the same or better level of service, at a savings to the general public (Agyemang, 2011).

There are several types of partnerships in which public and private sector can engaged in – policy partnerships, partnerships for delivery of public services, capacity building partnerships, economic development partnerships and infrastructure partnerships. Depending on the context (policy, service, capacity, economic development or infrastructure), a partnership between public, private and non-profit partners will be defined in different ways (Roman, 2015). Roman (2015) further opined that PPP is conceptualized as a contractual agreement between one or more public agencies and one or more private sector partners for the purpose of supporting the delivery of public services or financing, designing, building, operating and/or maintaining a certain project for the public good. These types of partnerships are usually developed with the implicit and explicit objectives of leveraging additional financing resources and expertise, which otherwise might not have been available for public purposes through traditional procurement practices.

### **Models of PPP**

There are various types of PPPs, established for different reasons, across a wide range of market segments, reflecting the different needs of governments for infrastructure services. Although the types vary, they are however been put in two broad categories of which PPP can be identified. The first is the contractual type consisting of the concession model where the 'user pays 'and the second is the Private Finance Initiative (PFI) model where the 'public sector pays'.

Concessions, which have the longest history of public-private financing, are mostly associated with PPP. By bringing private sector management, private funding and private sector know-how into the public sector, concessions have become the most established form of this kind of financing. They are contractual arrangements whereby a facility is given by the public to the private sector, which then operates the PPP for a certain period of time. Oftentimes, this also means building and designing the facility as well. The normal terminology for these contracts describes more or less the functions they cover. Contracts that concern the largest number of functions are "Concession" and "Design, Build, Finance and Operate" contracts, since they cover all the elements: namely finance, design, construction, management and maintenance. They are often financed by user fees (for water project, gas and electricity, public transport, among others, but not for "social PPP projects" such as health, prisons, courts, education, and urban roads, as well as defence).

The second type is based on the UK Private Finance Initiative (PFI) which was developed in the UK in 1992. This has now been adopted by parts of Canada,

France, the Netherlands, Portugal, Ireland, Norway, Finland, Australia, Japan, Malaysia, the United States and Singapore (amongst others) as part of a wider reform programme for the delivery of public services. In contrast to concession, financing schemes are structured differently. Under PFI schemes, privately financed contracts for public facilities and public works cover the same elements but in general are paid, for practical reasons, by a public authority and not by private users (public lighting, hospitals, schools, roads with shadow tolls, that is, payments based on traffic volume, paid by the government in lieu of tolls).

The capital element of the funding enabling the local authority to pay the private sector for these projects is given by central government in the form of what are known as PFI "credits". PFI is not just a different way of borrowing money; the loans are paid back over the period of the PFI scheme by the service provider who is at risk if the service is not delivered to standard throughout. The local authority then procures a partner to carry out the scheme and transfers detailed control and in theory the risk, in the project to the partner. The cost of this borrowing as a result is higher than normal government borrowing (but cheaper when better management of risks and efficiency of service delivery is taken into account). Based around different types of contract and risk transfer, these are PPP models that allocate responsibilities and risks between the public and private partners in different ways.

### **Project governance**

Project governance has been conceived as how the organisation directs and controls its projects in order to efficiently, effectively and transparently makes decisions. Nevertheless, project governance as a term is probably one of the most misunderstood, terms in modern project management. It has attracted research attention considerably in the construction industry and therefore immersed in definition uncertainty. Due to a the lack of a comprehensive, formal definition, various industries, institutions and organisations have adopted the term and derived their own connotations to suit their specific applications (Bekker & Steyn, 2009). The information technology industry, for example, associates project governance with protection of and access control to information (Turbin, 2003; OGC, 2005), while the public-private partnership (PPP) related organisations (Miller & Hobbs, 2005) use the term to describe the macro controlling environment within which projects should function. The definition related to public-private partnership is simply the quest to improve overall project performance.

The definitions for project governance vary from very narrow to very broad (Aholu et al. 2014). For example, Turner and Simister (2001) adopted an economics-based perspective on project governance, defining the concept narrowly as a contract type used in the project (such as fixed price or cost plus), whereas other authors have offered considerably broader definitions for the concept. For example, according to Ruuska et al. (2009), project governance employs principles for responding to project stakeholder demands, documentation procedures, communication and contractual arrangements. Many institutions and industries have also applied the term to suit their application (Bekker & Steyn, 2008). However, the overriding application in the context of the construction project is centred on three basic variables: organisation, management and policy framework (Patel & Robinson, 2010). In mega project delivery, project governance involves the

coordination, management and prompting the distribution of resources to attain agreed goals (Patel & Robinson, 2010).

The summary of the main features of project governance as internal to a specific project consists of the following:

- A project is a nexus of interdependent economic transactions between legally independent firms;
- The project is a powerful organizational actor that is directed by a specific joint goal (such as the construction of a building);
- The short-term and long-term goals of firms participating to the project may conflict with each other – and the goal of the project;
- A governance structure consisting of shared coordination, control, and safeguarding mechanisms needs to be put in place to align the interests of multiple organizational actors to work towards a joint goal;
- The governance structure of the project should be aligned with both internal (organizational capabilities) and external contingencies (regulatory practices).

## **PPP EXPERIENCE AND PROJECT GOVERNANCE IN NIGERIA**

### **Public Private Partnerships**

The emergence of PPP schemes serves as basis for rapid infrastructural development without directly impacting on the government's budgetary constraints. This comes to agree with the philosophy behind the Nigeria's privatization and commercialization decree of 1999. In recognition of the potential role of PPP in infrastructural development in Nigeria, the government in 2008 established the Infrastructure Concession Regulatory Commission (ICRC) to develop and take the lead on development of a harmonized PPP policy in the country (NIQS, 2010; Ibrahim & Haddary, 2010). Though the concept is relatively new, there is the increasing need to create a more workable and more efficient procurement protocol to improve the current practice and secure the future of PPP projects in Nigeria.

The most popular PPP delivery mechanisms used for a variety of infrastructural projects in Nigeria are the Joint Venture (JV) and the Build-Operate-Transfer approaches (Ibrahim, Price and Dainty 2006). Although the application of PPP requires some well levelled structure for implementation, there is no specific PPP structure at the federal level of government in Nigeria (Ibrahim and Haddary, 2010). All the concession projects are under the auspices of the National council of privatization and the Bureau for Public Enterprise (BPE) (Global Legal Group, 2007).

Nigerian government and her different agencies have implemented several infrastructural projects using the Public-Private Partnership mechanism. For example, the domestic terminal of Murtala Muhammed International Airport, Lagos, which was partially destroyed by fire in 2000, was re-built through a syndicated medium term refinancing facility from a consortium of six Nigerian banks (Akinyemi 2010). Other examples include Bi-Courtney MM2 airport project

in Lagos; terminal operation of sea- ports in Lagos, Warri and Port Harcourt (Njidda 2009; NIQS, 2010) and Lagos–Ibadan Expressway expansion project (NIQS, 2010).

States in Nigeria with known involvement in PPP are the Federal Capital Territory (FCT) Abuja, Lagos, Rivers, and Cross River. For instance, in 2004, Lagos state government promulgated the Lagos State Roads, Bridges and Highway Infrastructure (Private Sector Participation) Development Board Laws which provided a legal structure for PPP to come into play (Global Legal Group, 2007). Notable PPP projects in Lagos state include: the Lagos state light rail project and the Lekki expressway project. Those in FCT Abuja include: BOT market and Katampe district engineering infrastructure. Many other state governments in Nigeria have expanded the scope of PPP utilization to include roads, railways, airports, hospitals, water supply, power generation and distribution, waste management, transportation, ferry services, facility management, tourism, and such other commercial infrastructure as shopping complexes, security surveillance, markets and hotels and public conveniences (Omagbitse, 2010). However, the major challenge to the execution of the of projects in the country is governance.

### **Project Governance in Nigeria**

In Nigeria, increasing numbers of studies have demonstrated strong relationship between project governance with project success (Jooste, 2009; Awuzie & McDermott, 2012; Ogunsina & Ogunsemi, 2012). Many projects in Nigeria are trailing behind set objectives not just in cost, time, quality but in other success parameters such as local content development (Awuzie & McDermott, 2012), empowerment, employment, technology transfer and other socio-economic pushes (NPC, 2004). Jooste (2009) maintained that the lack of proficiently governed projects is common place in developing countries.

Using the Agency Theory, Ogunsina & Ogunsemi (2012) identified three basic challenges inherent to project governance structure in Nigeria. These include the possession of hidden action and agenda; the agent as utility amplifier seeking first his own interest, and the cost of monitoring agent's activity in the project web. Studies in other parts of the world (OGC, 2008; Levitt et al., 2005), identified other challenges to include: lack of clear links between the project and the organisation's key strategic priorities including agreed measures of success, and lack of effective engagement with stakeholders. Others include lack of skills and proven approach to project management and risk management, little attention development and implementation into manageable steps, initial priced based evaluation of proposals rather lifecycle value for money, the lack of appropriate project team integration between project board and the supply chain also impedes the governance of projects, heightened levels of uncertainties and risks and dimensions of social and political conflicts (Levitt et al., 2005).

## **ASSESSMENT OF THE SUCCESS IN PPP PROJECTS**

Project success has been defined in diverse ways by researchers and each definition varies depending on the type and size of project (Chan& Chan, 2004). As an approach towards achieving project success, PPP has been widely applied across the world by governments to provide a sequence of important public services (e.g., health, education, water and electric power supply, and transport) since the global

financial crisis, owing to the limited funds available for main infrastructure development. Despite more and more successful operations of PPPs, there are some project failures such as cost overruns, schedule overruns, and stakeholder dissatisfaction. There are numerous criteria and factors critical to the success of a PPP projects and their effective performance evaluation. According to Yong (2010), the debate about PPP has moved from the ideological argument of their advantages and disadvantages to the management about how to structure them well to achieve the predetermined goal, and therefore performance evaluation must be properly addressed during PPP delivery.

There are some explanatory factors that account for the success and failure of PPP projects and there are some indicators with which the success and failure are determined or measured, especially in relation to PPP projects. (Zhang, 2005). These indicators for measuring the success or otherwise of PPP projects are called Critical Success Criteria (CSC) while the explanatory factors are called Critical Success Factors (CSFs). These concepts are different but related. CSC comprises the successful outcomes of projects and are the parameters on which success is measured while CSFs are the driving forces to achieve successful project outcomes; the set of circumstances and facts, which facilitate project success.

### **Critical success criteria (CSC) for PPP projects**

Over time, researchers have criticised the exclusive use of the conventional success measures of time, cost and quality for construction projects. Some have suggested the incorporation of other subjective success measures. For instance, Ahadzie et al. (2008) identified environmental impact and customer satisfaction as important additional success measurements aside the traditional set of success criteria for mass housing building projects (MHBP) in developing countries. Furthermore, ToorA and Ogunlana (2010) emphasized that safety, effectiveness, satisfaction of stakeholders, efficient use of resources and reduced conflicts are the success criteria which are very important in assessing large scale construction projects success compared to the traditional measures. Also, Westerveld (2003) strongly opined that clients 'appreciation, contracting partners 'appreciation, stakeholders ' appreciation, users 'appreciation and project personnel appreciation are important success measures aside the conventional criteria of time, cost and quality.

Notwithstanding, the traditional success criteria do not fully incorporate the proper implementation of construction projects but mainly focus on the contribution of profit (Cserháti, 2014). In addition, the traditional measures are geared towards the satisfaction of project clients and contractors without considering other external stakeholders 'expectations (Westerveld 2003; Al-Tmeemy et al. 2011). In this regard, it is always essential for project managers to establish a clear set of success criteria which integrate both objective and subjective measures in order to properly evaluate construction projects success (Cox et al.2003).

It has been opined that success measurement is necessary to realize the full objectives of PPP and is critical to project success (Beatham et. al., 2004; Gunasekaran & Kobu 2007; Liu et al. 2014). The success of PPP projects is based on identifiable agreed standard, goals and objectives (indicators) of PPP concept which form its Critical Success Criteria (CSC) for evaluation. And despite the fact that there is a large strand of literature on CFC with a focus on the traditionally



procured projects, studies also abound that identified success criteria for Public-Private Partnership projects in terms of greater value-for-money and provision of adequate financial return to the private investor (Ng et al. 2010), cost savings (Hambros 1999), reduction in construction time and maintaining a high level of service quality (Akintoye et al. 2003) and satisfaction of stakeholders (Leung et al. 2004; Udayangani et al. 2011). Considering the uniqueness of PPP projects, Akintoye et al. (2003) and Skietrys et al. (2008) opined that their success criteria will differ from the traditionally procured projects. Therefore, to have a full understanding of a successful implementation of PPP requires using some critical success criteria which are key points in measuring success of PPP projects.

### **Critical success factors (CSFs) for PPP projects**

Morledge and Owen (1999) developed the concept of CSFs further to identify certain weaknesses associated with the practical application of Rockart's method. These include: subjectivity; bias, human inability to process complex information, change in relation to surrounding environments; imprecise definitions and generalisations, and qualitative performance measures. Critical success elements are significantly important to help firms or organizations to identify key factors that firms should focus on in order to be successful in a project (Rowlinson, 1999). In terms of CSFs of PPP projects, studies have emerged since the 1990s. In general, there are two types of literature on the CSFs of PPP: studies that evaluate the CSF of PPP projects in general and studies that assess the CSFs of a specific PPP project.

To implement Public-Private Partnership (PPP) projects efficiently and effectively it may be necessary for all the stakeholders to be fully aware of the various success factors that can aid its successful implementation. Several PPP projects are currently under taken in Nigeria and other developing countries like India, Nepal, Latin America and as well as other African countries such as Egypt, South Africa, Kenya, Uganda, Mozambique to mention a few for their infrastructure developments. As discussed in some studies in Nigeria (Dada and Oladokun, 2008; 2012; Agboola, 2011; Babatunde, Opawole and Akinsiku, 2012; Olaniyan, 2013) there are several critical success factors (CSFs) that are investigated for successful implementation of PPP projects. Equally linked to these identified CSFs are also some critical success sub-factors that contribute to each category of CSF as well as to overall performance of PPP projects.

A number of authors have identified CSFs for PPP projects. Tiong (1996) identified six CSFs for private contractors in competitive tendering and negotiation in BOT contracts as: entrepreneurship and leadership; right project identification; strength of the consortium; technical solution advantage; financial package differentiation; and differentiation in guarantees. Qiao, Wang, Tiong, and Chan (2001) established eight CSFs in BOT projects in China as: appropriate project identification; stable political and economic situation; attractive financial package; acceptable toll/tariff levels; reasonable risk allocation; selection of suitable subcontractors; management control; and technology transfer. Jefferies et al. (2002) explored CSFs for BOOT procurement system specific to a Stadium in Australia.

### **The relationship between CSFs and CSCs for PPP projects**

The concepts CSC and CSFs have been used interchangeably by some management literature. However, these concepts are different but related. Based on the explanations above and as explained by Lim and Mohamed (1999), CSFs are the set of circumstances and facts, which facilitate project success. This implies that CSFs are actually the driving forces to achieve successful project outcomes (Rockart 1982). They are not themselves the successful outcomes. On the other hand, CSCs are the successful outcomes of projects and they are the parameters on which success is measured (Chan et al.2002). In PPP project implementation, both concepts are important in achieving success; they collectively operative within the framework of PPP projects success. In essence, there is a tight relationship between them in achieving PPP projects success (Lim, 1999).

Technically, to determine PPP projects success, the CSC for PPP projects act as the dependent variables, whereas the CSFs for PPP projects become the independent variables. To clearly illustrate the difference and relationship, reduced public and political protest could be considered a critical success criterion for PPP projects. For this criterion to be realised, it depends of several critical factors which include transparency, frequent communication and user fee adjustments. Though the critical factors influence the projects 'success, they do not form the basis for judgement but the critical criterion.

This study therefore proposes a framework of PPP project governance based on the objectives set for the study. The initial component of the framework is the project governance. This comprises elements such as organisational goal, organisational capabilities, regulatory practices including coordination, control and safeguarding mechanisms. These elements are seen as contributors towards the PPP structure for a particular project. The PPP structure consists of objectives of PPP, parties involved in PPP, types of PPP, models of PPP, including legal and administrative frameworks for PPP. Both the project governance and the PPP structure contributes to the critical success factors (CSFs) which are presented in their five categories adopted in this study. These are favourable economic condition, project implementation, effective procurement, government control and stable political and social environment. These CSFs together with PPP structure have direct influence on the Critical Success Criteria (CSC). These are project performance indicators and they are manifested in terms of cost of project, time of completion, quality of project, stakeholders 'satisfaction, value for money and environmental impact, among other success criteria. It is these success criteria that will be the basis of measurement of the success of any PPP project and the framework for the study will aim at achieving enhance service delivery performance of PPP in project governance.

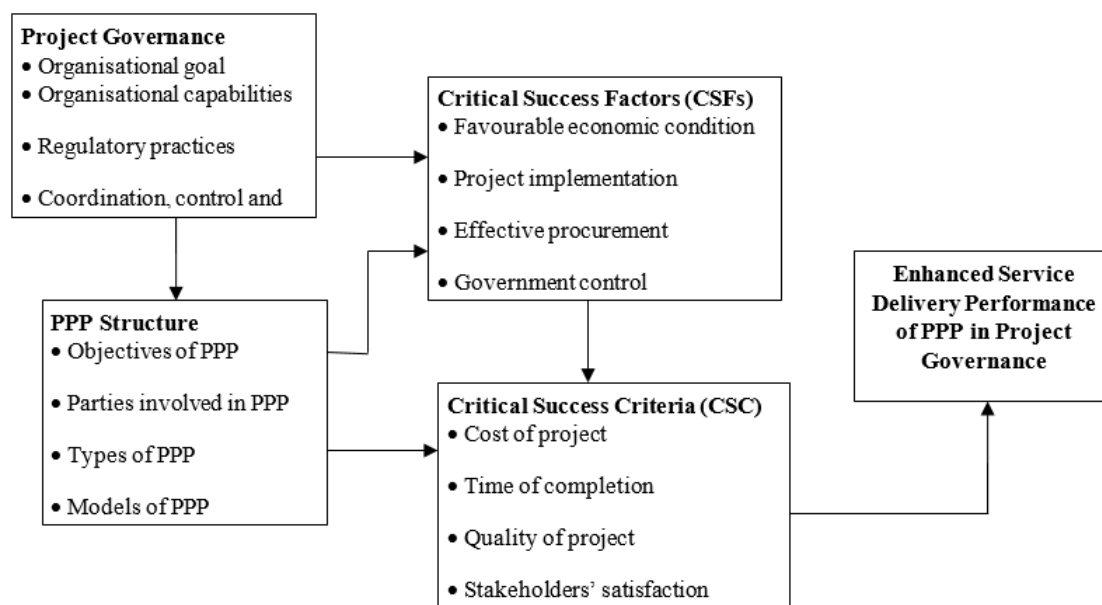

Figure 2.1: Framework to enhance service delivery performance of PPP

Source: Author's review, 2020

From the framework, elements of project governance (organizational goal, organizational capabilities, regulatory practices etc.) have a direct link to the structures of PPP (objectives of PPP, parties involved in PPP, types and models of PPP, legal and administrative structures etc.). This in unison determines the critical success factors (favourable economic condition, project implementation, effective procurement etc.) Afterwards the critical success criteria for the project (cost of project, time of completion, quality of project etc.) are determined. All these variables lead to enhanced service delivery performance of PPP in project governance.

## CONCLUSION

The governments are increasingly using public private partnership (PPP) procurement arrangement to deliver works and services in both developed and developing countries. The private sector is being used to providing public facilities through partnerships in order to address the infrastructural deficit without the financial commitment to the government, so that the limited available resources could be channelled to other sectors. The utilization of PPP as a procurement option has been adjudged with several benefits. These include provision of better infrastructure solutions than an initiative that is wholly public or wholly private, faster project completion and reduced delays on infrastructure projects by including time-to-completion as a measure of performance and therefore of profit, higher return on investment when compared with traditional approach, early appraisal of risks to determine project feasibility and achievement of high quality standards throughout the life cycle of the project. PPP as a method of construction in Nigeria failed many times because majority of the stakeholders do not detailed the organization and implementation of PPP principles in line with its objectivity and goals. For PPP implementation to be successful there must be a balance of

interest among stakeholders involved and a PPP framework must be designed to best achieve the government objectives in pursuing PPPs.

## REFERENCES

- APM (2012). Project governance and Project Management Office (PMO) <https://www.open.edu/openlearn/ocw/mod/oucontent/view.php?id=27294&printable=1>
- Ahadzi, M., & Bowles, G. (2001). Public-private partnerships in project procurement: can the UK initiative offer developing countries some useful lessons? The 17th Annual Conference of ARCOM, Salford.
- Ahadzi, M., & Bowles, G. (2001). Public-private partnerships in UK's infrastructure development: the Macroeconomic perspective, 17th Annual Conference of ARCOM, Salford, September, pp. 971-980.
- Ahadzi, M., & Bowles, G. (2001). Public-private partnerships in infrastructure procurement: An evaluation of consortium attributes, The 17th Annual Conference of ARCOM, Salford.
- Agyemang, P. F. K. (2011). Effectiveness of Public-Private Partnership in Infrastructure Projects. Master's Thesis from Department of Civil Engineering, University of Texas.
- Awuzie, B. & McDermott, P. (2012). Using System Viability Approach to Investigate the Social and Economic Impact of Energy Infrastructure Investment on Local Supply Chain Development – A Case of Nigeria's Niger Delta Region, Working Paper Proceedings, Engineering Project Organisations Conference, Rheden, The Netherlands, July 10 -12.
- Babatunde, S. O., Opawole, A., & Akinsiku, O. E. (2012). Critical Success Factors in Public Private Partnership (PPP) on Infrastructure Delivery in Nigeria. *Journal of Facilities Management*, 10(3), 212-225
- Becker, M., & Steyn, (2009). Project Governance: Definition and Framework, *Journal of Contemporary Management*, 6: 214 -228
- Bovaird, T. (2004). Public-Private Partnerships from Contested Concepts to Prevalent Practice, *International Review of Administrative Sciences* Vol.70, 2. 199-214.
- Bekker, M. C., & Steyn, H. (2009). Defining 'Project Governance' For Large Capital Projects. *South African Journal of Industrial Engineering* 20(2): 81-92
- Cheung, E., Chan, A. P. C., & Kajewski, S. (2012). Factors contributing to successful public private partnership projects, comparing Hong Kong with Australia and the United Kingdom, *Journal of Facilities Management* 10(1): 45-58. <https://doi.org/10.1108/14725961211200397>
- Cheung, E., Chan, A. P. C., & Kajewski, S. (2009). Reasons for implementing public private partnership projects: perspectives from Hong Kong, Australian and British practitioners, *Journal of Property Investment & Finance* 27(1): 81-95. <https://doi.org/10.1108/14635780910926685>
- Davies, T., Crawford, L. H., & Lechler, T. G. (2009). Project Management Systems: Moving Project Management from an Operational to a Strategic Discipline. *Project Management Journal* 40(1)10.1002/pmj.20106
- Ekung, S., Agu, L., & Iheama, N. (2017). Influence of Project Governance on Project Performance: Evidence from Nigerian Case Studies *PM World Journal* 5, (7), 1-18

- Gbadegesin, J. T., & Aluko, B. T. (2014). Public Private Partnership/Private Finance Initiative for Financing Infrastructure in Public Tertiary Institutions in Nigeria. *Journal of Built Environment Projects and Asset Management*, 4(2).
- Harris, Clive. (2003). *Private Participation in Infrastructure in Developing Countries: Trends, Impacts, and Policy Lessons.* World Bank Working Paper 5. Washington, DC: World Bank
- Ibrahim, A., & Musa-Haddary, Y. (2010). Concept of Value for Money in Public Infrastructure Development. Paper presented at the workshop on private, public partnership approach to infrastructure development in Nigeria. organized by the Nigerian Institute of Quantity Surveyors: Date July 2010
- Khosravi, S. & Afshari, H. (2011), "A success measurement model for construction projects", In *International Conference on Financial Management and Economics IPEDR*, Vol. 11, = pp. 186-190
- Koppenjan, J. F. M. (2005). The formation of public-private partnerships: Lessons from nine transport infrastructure projects in the Netherlands. *Public Administration*, 83, 135-157
- Leiringer, R., & Hughes, W. (Eds) *Procs 4th West Africa Built Environment Research (WABER) Conference, 24-26 July 2012, Abuja, Nigeria, 1053-65*
- Levitt, R. E., McAdam, D., Orr, R. J., & Scott, R. W. (2005). Addressing Institutional Interest and Conflict: Project Governance Structure for Global Infrastructure Development, a Proposal Submitted to Presidential Fund for Innovation in International Studies.
- Liu, T. Wang, Y., & Wikinson, S. (2016). Identifying critical factors affecting the effectiveness and efficiency of tendering processes in Public-Private Partnerships (PPPs): A comparative analysis of Australia and China. *International Journal of Project Management* 34(4):701-716.10.1016/j.ijproman.2016.01.004
- Miller, R. & Hobbs, J. B. (2005). Governance regimes for large complex projects. *Project Management Journal*, 36(3), 42-50.
- Osei-Kyei, R., & Chan, A. P. C. (2015). Review of studies on the critical success factors for public private partner-ship (PPP) projects from 1990 to 2013, *International Journal of Project Management* 33(6): 1335-1346. <https://doi.org/10.1016/j.ijproman.2015.02.008>
- Omagbitse, B. O. (2010). Project Finance Issues for Infrastructure Provision. A Presentation to The Nigerian Institute of Quantity Surveyors' 3 – Day Workshop on Public Private Partnership Approach to Infrastructure Development in Nigeria; July 2010.
- Ogunsina, O., & Ogunsemi, D. R. (2012). Assessing Project Procurement Governance Structures In Construction: The search for a Unified Theory In: Laryea, S., Agyepong, S.A.,
- Patel, M., & Robinson, H. (2010). Impact of Governance on Project Delivery of Complex NHSPFI/PPP Schemes, *Journal of Financial Management of Property and Construction*, 15 (3): 216 –234
- Turbin N. (2003). IT Governance and Project Governance. The Project Perfect White Paper Collection. Available from <http://www.projectperfect.com.au>, accessed 24 February 2021
- Toora, S. T. and Ogunlana, O. T. (2010). Beyond the 'iron triangle': Stakeholder perception of key performance indicators (KPIs) for large-scale public sector development projects. *International Journal of Project Management* 28, 3; 228-236

- Van Ham, H & Koppenjan, J (2001). Building Public-Private Partnerships: Assessing and managing risks in port development *Public Management Review*3(14) 596-616
- Wateridge, J., IT Projects: A basis for success, *International Journal of Project Management*1995, Vol 13, No.3, p169-172
- World Bank (2015). World Bank Group Statement on Policies, Accountability Mechanisms and Stakeholder Participation in WBG Projects. <https://www.worldbank.org/en/news/press-release/2015/06/22/world-bank-group-statement-on-policies-accountability-mechanisms-and-stakeholder-participation-in-wbg-projects>
- World Bank. (2015). Private participation in infrastructure (PPI), Regional Snapshots [online]. Washington, DC. Available at: [http://ppi.worldbank.org/explore/ppi\\_explore\\_Region.aspx?regionID=1](http://ppi.worldbank.org/explore/ppi_explore_Region.aspx?regionID=1) [accessed March 2021]
- Zhang, X. Q., (2005). Critical success factors for public–private partnerships in infrastructure development. *J. Constr. Eng. Management.* 131, 3–14



# DEVELOPMENT OF SOCIAL HOUSING AGENDA TO SOLVE HOUSING DEFICIT IN SUB-SAHARA AFRICA: A CASE FOR OGUN STATE, NIGERIA

Babatunde Adekoyejo Jolaoso<sup>1</sup> and Olusegun Olaopin Olanrele<sup>2</sup>

<sup>1</sup>*Department of Architecture, School of Environmental Studies, Moshood Abiola Polytechnic, Abeokuta, Nigeria*

<sup>2</sup>*Department of Real Estate, Faculty of Built Environment, University of Malaya, Kuala Lumpur, 50603, Malaysia*

The cumulating housing deficit and its consequences in most Africa nations has called for a review of housing policies and initiatives across the sub-Sahara Africa. Scholars have advocated integrative social housing (SH) strategy as possible solutions for adequate supply of housing to the citizenry. The paper reviewed the State's policy initiatives to solving housing provision challenges in Ogun State, Nigeria. The aim is to showcase the efficacy of social housing programme as a sustainable option to providing housing that meets the need of low-medium income group of the population in terms of accessibility and affordability. The study adopts qualitative research approach, using content analysis of reviewed literature and a Focus Group Discussion (FGD) of 10 professionals in the built environment from the academia. The study found that there is neither a specific policy/programme for social housing nor development models in Ogun State. The paper suggests policy reforms incorporating SH initiatives within the notion of affordability in the open-market economy. This study in its contribution to solving housing problem, viewed social housing with the involvement of the Private Sector as a possible solution to eradicate housing supply deficit in Sub-Sahara Africa.

Keywords: development models, housing supply, intervention, policy, social housing

## INTRODUCTION

Housing supply deficit and its resultant homelessness, slum development and informal settlements in most Africa cities, necessitate the review of policies and initiatives in the housing sector (Olanrele, Jolaoso and Adegunle, 2018). The government inability to meet the housing demand of its population in various markets has led to concession of the provision of housing by the government to the profit focused private sector, which in turn brought about housing units of exorbitant prices that are unaffordable to the target-inhabitants. Housing policies and projects in Africa, especially in Nigeria, have always been seen as politically

---

<sup>1</sup> koyejolaoso@gmail.com; koyejolaoso@yahoo.com

<sup>2</sup> olanrelesegun@yahoo.com

motivated interventions against fair and equity consideration for those who are really in need of the housing units. Therefore, the prevalence of housing inadequacy and supply deficit in urban centres continues to grow unabated with the concomitant proliferation of informal, slums and squatter settlements resulting in overcrowding (Olanrele et al., 2018). Omirin (2002) and Ogunba (2009) attributed the housing supply deficit in Nigeria to inadequate funding. This implies that, both the supply and demand end of housing delivery are greatly affected by financial ability and capability.

Daramola (2004); Moskalyk (2008) and Ibem (2011) agreed of the government intervention in housing provision for the low-income population in the form of Private Public Partnership arrangement since 2002 but the evidence shows that the products of the PPP in the housing sector are far above the affordability level of the target low income group. Addo (2014) was of the opinion that housing should be revisited as social policy programme; that, the public sector cannot leave such a social programme completely in the hands of the profit oriented private sector; and therefore, advocated that an effective Public Private Partnership application to housing sector can efficiently address the low income housing, if sincerely pursued towards innovative multiple (high-rise/multi-floor) dwellings against the single family houses introduced by the colonial masters. Jolaoso, Arayela, Taiwo and Folorunso (2017) underscored the importance of the deployment of integrative informal housing and social housing as strategy towards addressing the housing needs and supply for the different categories of citizens, especially for the urban poor.

It is in this stead that Olanrele, Jolaoso and Adegunle (2018) noted that, a good number of studies have investigated the failure of many developing nations in housing provision and the findings attributed the challenges to finance, land tenure system, cost of building materials and several other factors. Their study opined that, effective housing delivery should encompass availability, adequacy, accessibility, affordability and acceptability; these are intertwined as their interplay determines the efficiency and sustainability of housing delivery in any nation. Hence, the need for government's demonstration of commitment to her social responsibility towards increase in housing supply through social housing development initiatives.

In Nigeria, between 1950 and 1990, government was directly involved in the initiation, direct construction, maintenance and management of housing. Housing delivery was mostly in the form of official quarters or residences for the military, public and civil services 'employees which were adopted to address the challenges of quality and adequate housing. The establishment of the Federal Mortgage Bank of Nigeria (FMBN) in 1978 was to ease the problem of home finance. In addition, there were various site and services scheme from government for the rich people to buy plots and develop their houses. Various housing estates were also developed to increase the housing by both the federal and state governments in Nigeria (such as Gowon housing estate in Lagos, Federal Housing Estate, Sagari Estate across the country by Federal government and different state housing scheme evolved in the states too. In 1990 the mortgage finance system was liberalised and Primary mortgage institutions were licenced to ease the access to mortgage loan following the National Housing Policy supported with the National



Housing Act Of 1992. The adoption of private participation in housing delivery led to the establishment of Real Estate Developers Association of Nigeria who have access to the National Housing Fund from the FMBN to increase housing development activities. However, all these initiatives and policies have not been able to create enough housing units for the citizenry and individuals (especially low/medium income group) still go through building development process on instalment basis as they have fund which takes more than 10 years to complete.

This paper examines previous government's policy initiatives towards housing provision in Ogun State, Nigeria and advocate the social housing strategy with the aim of providing accessible, affordable, acceptable, replicable and self-sustaining housing that will meet the housing need of the target-groups of low, lower-medium and medium income population. The specific objective of the paper is to proffer a practical demonstrable solution through a proposed pilot social housing scheme in the study area, capable of increasing the number of existing dwelling units in the study area by about 100%.

The Laderin Workers 'Estate in Abeokuta was selected as pilot scheme for social housing scheme practical demonstration for Ogun State, Nigeria, taking into consideration the social needs and the economic capacity of the target-groups of the low and lower-medium and medium income population/households. Laderin Workers 'Estate is within Abeokuta and within the contiguous location of the administrative as well as the seat of power of the capital city of Ogun state, Nigeria. It has an estimated projected population of about 624,700 with a density of about 5246.2/km<sup>2</sup> and an area coverage of about 879.0km<sup>2</sup>. It has a relatively population growth rate of 3.36%/year and possesses advantage of leveraging on subsisting government land acquisitions. Abeokuta hosts most of the Federal and State governments 'Ministries, Departments and Agencies; an international stadium, hospitality businesses, auto technician workshops, train station; markets, public and private investments institutions, public and private housing estates, light industries etc. It has ease of access to fleets of hotels and tourist centres for recreational and cultural events like Olumo rock, Lisabi Day, traditional adire (tye and dye) Carnival, Drums Festival etc.

The area is currently experiencing gradual integrative transformation as Central Business District with the on-going urban renewal, upgrading of infrastructure, standard rail and road expansion. Laderin Workers 'Estate comprises 217 plots on 17,360m<sup>2</sup> with an estimated 1302 households. Subsisting government land acquisition along that corridor for urban physical expansion or development can be leveraged upon for the social housing delivery that can be accessible, affordable, acceptable, replicable, and self-sustainable. To this study, the target-group in Nigeria is categorised as those in public/civil service's salary grade level 1-9 which are usually categorised as workers earning ₦30,000 – ₦167,875 (about \$75- \$425) per month as salary.

## **HOUSING SUPPLY INITIATIVES - AN OVERVIEW**

In the developed (western) countries, the direct involvement of the government in the housing supply/delivery have drastically reduced from the 20th century. Between 1950 and 1975, government operated as initiator and provider of

affordable units by direct construction, maintenance and management, which resulted into rural-urban migration. By the end of 1975 and early 21st century, the government focussed on the provision of housing was to address the challenges brought about by the post-war backlogs of housing deficits in the forms of social housing projects, provision of subsidies for housing construction and support to institutional structures. Today, the government of most western countries have withdrawn as provider of housing to become enabler and facilitator through the support of private sectors with focus on rental and ownership; providing subsidies and allowances to deserving individuals and organised private sector entities to engage in housing delivery (UN-Habitat, 2011; Gilbert, 2004; and Calavit and Mallach, 2009)

In a developing country like Nigeria, the review of literature shows that, between 1950 and 1990, government was directly involved in the initiation, direct construction, maintenance and management of housing. Housing delivery was mostly in the form of official quarters or residences for the military, public and civil services 'employees which were adopted to address the challenges of rural-urban migration, urban poor and slum formation through conventional and non-conventional approaches (such as self-help, site and services, site without services, slum upgrading, etc.). Government's involvement in housing of most developing countries has also shifted from being provider into dual role of a provider and enabler or facilitator or both in order to meet the ever-growing housing needs. Thus, government of Nigeria have gradually shifted from being the provider and enabler of the supply of housing and houses to being the facilitator and regulator. As a result, the supply of housing is being driven by the market forces through the participation of private developers and investors especially on rental, ownership and commercial housing schemes (Ibem, 2011; UN-Habitat, 2011; and Gilbert, 2004). It therefore, underscores the relevance or importance of the development of social housing.

Historical review of housing policy development in Nigeria in the past five decades indicates that, housing policy initiatives and programmes have been by way of intervention in housing provision for the citizenry in the form of skeletal or quasi manifestation of housing schemes like mass housing, low-cost housing, staff quarters, workers 'estates and civil servants housing estates or schemes at the Federal, State, Local government levels (Arayela, 2002, 2004; Jolaoso, et al, 2008; Arnott, 2008; Kalu, Agbarakwe and Anowor, 2014 cited in Jolaoso, 2017a; and Ibem, 2011a).

In Ogun state, the housing initiatives include the housing estate inherited from the defunct western region at the state's creation in 1976, the Ibara housing estate for the civil servants. Between 1976 and now, more housing estates were developed by the Ogun State Housing Corporation including Oke Ata Housing Estate, Ewang Housing Estate, Asero Housing Estate, Elegu Housing Estate, Laderin Housing Estate etc, for both the civil servants and the public. In the area of housing finance, the state established Gateway Savings and Loans Limited, a mortgage finance outfit. Site and services scheme were also created for individuals to buy plots and develop their dream houses. With the private participation initiative in housing supply, various private developers were allocated land for development. The Obasanjo Hill Top Estate is one of the private developers 'contribution to housing

delivery. Most of these estates are beyond the affordability level of the low income group even the Laderin Estate that was tagged 'Workers Estate'. Laderin Estate is equally poor in term of infrastructure provision, the cause for the choice Laderin Estate for this study.

### **Social housing**

Attempts have been made by researchers and authors to define or described social housing in different contexts. Some authors have often conceived of or interchangeably understood social housing in the context of low-cost or low-income housing, affordable housing, mass housing, informal housing, slum upgrading or incremental housing and accretions as housing solution for the poorest people. Ayala and Geurts (2013) defined social housing as the provision of a formal housing solution, in principle, which has sufficient potential to be attractive to the market when government provides adequate incentives or interventions.

In the Klynveld Peat Marwick Goerdeler (KPMG)'s Report of 2012, social housing was used to describe public, community and transitional housing, in agreement with the position Van der Moolen (2015); Priemus (2010); Peppercorn and Taffin (2013) and Czischke, 2017). It can therefore be inferred from these definitions and descriptions that, social housing (SH) is a solution to housing provision or supply; as well as a form of housing provision designed to directly provide housing assistance to target-groups, who are mostly in need and ordinarily are unable to afford or access such from the private housing markets without support. Therefore, social housing entails public sector, private sector and a target group's' participation in housing delivery. Anecdotal evidence (from the government officials and building industry players through informal discussions with the lead author) has also revealed that there is little or no clear-cut policy on social housing in Nigeria. There is neither context-specific programme nor practical-based project(s) in the notion of social housing in place. However, it is observed that current efforts to achieving this are underway through pockets of discussions among relevant stakeholders towards the formulation of a comprehensive and effective National policy on social housing (Federal Government of Nigeria, 1991, Federal Republic of Nigeria, 2002, 2006; Ogun State Ministry of Housing, 2008).

In realization of the need to strike a balance between the housing need of the people, political willingness and the financial realities, the Ogun State Government under the 2011-2015 transformation agenda built a number of new housing estates at designated areas across the three (3) senatorial districts. These were characterised by uncompleted and inefficient infrastructure; use of dysfunctional earth road, water and electricity supply; and are without schools and other socio-economic facilities (Ibem, 2011a). These were allocated-to-own at highly subsidized construction prices to eligible civil and public service workers that are National Housing Trust Fund (NHTF) contributors or participants under the mortgage system through Federal Mortgage Bank of Nigeria (FMBN). However, events have shown deterioration in infrastructure arising from default or low rate of repayment; low earnings and delay in salary payment; as well as the realities of the government's inability to continue funding direct construction of houses, as there seems to be no succinct mechanisms for dealing with defaults in repayments (Ibem, 2011; Jolaoso, 2017a; Olanrele, et al, 2018).

Based on the account of the housing affordability audit exercise conducted by the Value Chain Projects Consultant Limited on the Ogun State Housing Corporation's delivery of affordable housing (Q1-2017-2018 Pilot-starter homes project), the scheme appears not to be faring any better in delivering the expected result. The delivery cost and offered price for sale per dwelling unit of one-bedroom apartment at ₦3.5million (\$11,500) is practically out of reach of the targeted population. Most of the houses remain largely unoccupied, while those occupied or subscribed for are by the rich, who ordinarily can afford even at over and above the going or offered prices and are not really in need of the houses but at best, can be described as speculative buyers or subscribers. In spite of these initiatives, there is practically insufficient housing provision for the low income group and this situation is prevalent in most developing countries (Boamah, 2014; Olanrele et al., 2018). Thus, the initiative by the government of Ogun State appears to have suffered the lack of social housing scheme(s) as previous authors had highlighted (Omirin, 2002; Mahama & Antwi, 2006; Ogunba, 2009; ; Muhammad & Bichi, 2014 and Kabir & Bustani, 2017). Fuller Centre Report (2014), Maigua (2014); and Awuwafoje (2013) have revealed that, the obstacles to social housing projects are numerous and include the following:

- i. Elite supplanting of the programme and inability of the government to apply the lessons from the previous experiences of failures.
- ii. Low earning power, high interest, and inflation rates to attract direct financial institutions and developers 'investment.
- iii. Inadequate policy and implementation strategies for social housing delivery
- iv. Lack of government commitment, political will, and Nepotism/political compromises at the detriments of the target population for which the programme was intended.
- v. Prohibitive high value and cost placed on land.
- vi. Inadequate affordable and long-term mortgage facilities
- vii. High cost of and tedious procedure for obtaining land-title and development permit.
- viii. Inadequate or poor knowledge or enlightenment about the advantages associated with social housing towards increasing the housing stock, especially for the urban poor.
- ix. Inadequate investment in research, training and development of appropriate skills, materials and construction technology for the production of buildings and maintenance of social housing

The foregoing suggests the need for this proposal as a pilot scheme that can possibly be replicated in other locations in the State and elsewhere in Nigeria.

## METHODOLOGY

The study adopted the combination of content analysis of related reviewed literature and a Focus Group Discussion (FGD) qualitative study approach (Mitlin, 2011). The FGD panel of ten (10) comprises two (2) each from five (5) professional groups of Architecture, Building Technology, Urban & Regional Planning, Quantity Surveying and Estate Management & Valuation. These participants were selected from amongst academic staff of the School of Environmental Studies of the Moshood Abiola Polytechnic, Abeokuta whose core area of interest is housing and urban studies. They are all professionally qualified, competent, registered to practice in Nigeria and are in active practice for at least ten years in their respective discipline.

The focus group discussion was moderated by the researcher with two other research assistants from amongst the panel members as recorder and observer. Questions addressed at the discussion largely borders on the Government's housing policies and initiatives; housing supply, affordability, accessibility and acceptability; finance, socio-economic groups and design considerations; development models, key stakeholders and their roles. In addition, a list of parameters/factors extracted from the literature review and policy analysis were presented to the discussants to rate their agreement on a likert scale of 1-5, ranging from strongly disagree to strongly agree. The discussion was a two-day event and was held at a meeting room in the Academic Planning Unit of the Moshood Abiola Polytechnic, Abeokuta that was found convenient for the purpose. The contents of identified common themes from opinions and responses to the issues were collated and analysed in relation to information extracted from the reviewed literature. These were presented as findings and constitute the major basis for the proposal on the social housing scheme. Audio-visual recording was not taken, and anonymity of the participants was maintained in order to gain the confidence of participants. Figures 1 and 2 illustrates the block diagram and flow chart of research methodology respectively.

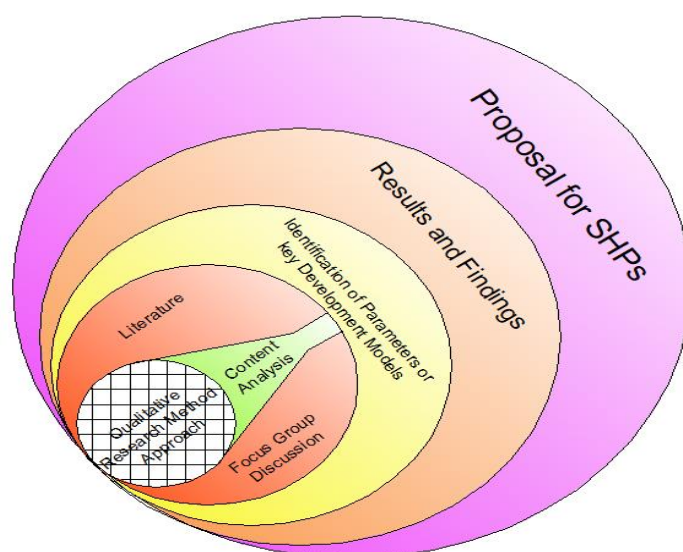

Figure 1: Block diagram of research methodology (Author's illustration)

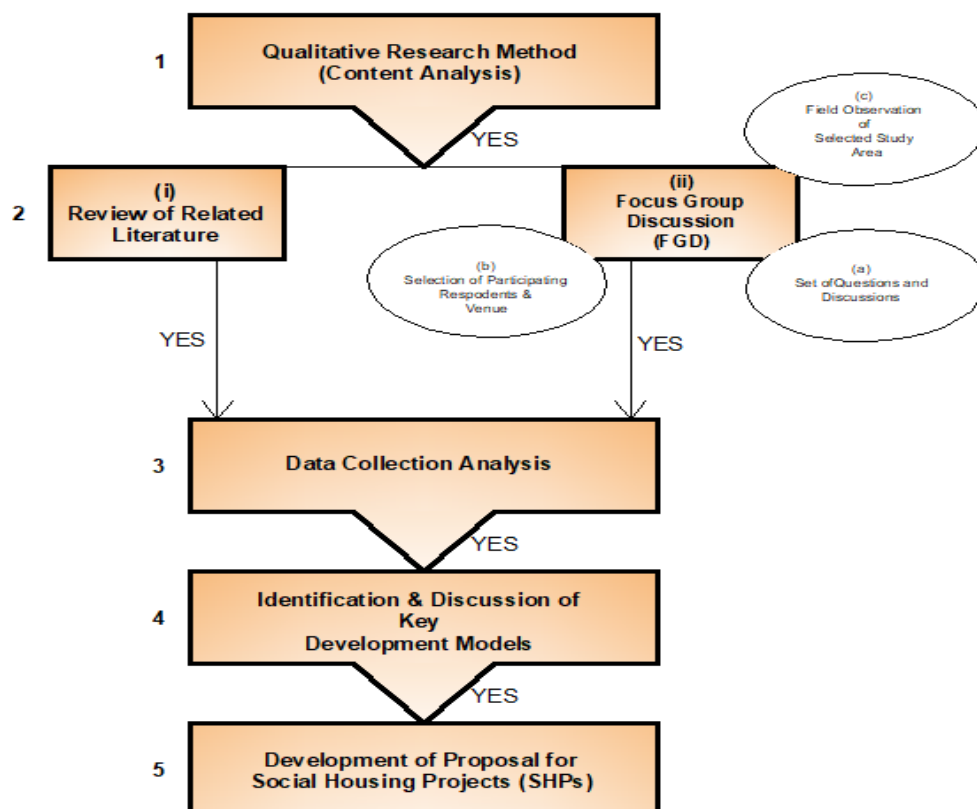

Figure 2: Research methodology flow chart (Author’s illustration)

## FINDINGS AND DISCUSSION

The panel was unanimous that, there is neither any clear-cut policy nor any practical-based project(s) in the notion of social housing in place in Nigeria; and that, social housing (SH) can be described as a solution to housing challenge in the nation, while corroborating the opinion that SH is a form of formal housing solution with adequate potential to be attractive to the market. The submissions appear to agree with the positions of Ayala and Geurts (2013) and Jolaoso et al. (2017) and also affirmed the need for the development of a practical and context-specific social housing agenda for Ogun State, Nigeria.

To drive and develop the social housing agenda, the study sought information across and discussed on the most relevant development models or key parameters as extracted from the literature (Moss, 2003; SHF/Development works, 2004; Gilbert, 2004; Moskalyk, 2008; Calavita and Mallach, 2009; Social Housing Foundation, 2010; Ibem, 2011; UN-Habitat, 2011; UN-Habitat and Gilbert 2011; and Czischke, 2017).

Table 1 present the fourteen (14) development models or key parameters extracted from the reviewed literature and the rated responses by the FGD. Out of the 10 discussants, seven (7) fully participated to the end and gave their responses to the listed parameter distributed to them at the beginning of the FGD. The other 3 who left earlier did not return their questionnaire. The responses from the participants agreed that the tenure, stakeholders, target groups, delivery strategies, housing needs assessment, financial, access to land for development and design

considerations are the eight (8) key development parameters by according the parameters the most favourable response possible (MFRP). The delivery agent, management and maintenance, cooperative and community participation are the four (4) development key parameters that have least favourable response possible (LFRP) by the discussants, while the performance agreement and performance quality are the two (2) development models or key parameters with neutral responses possible (NRP). The key development models/parameters identified and discussed by the FGD panel members are presented in turn below.

### Target groups models

These were classified as low, lower-medium, medium and high-income groups. The low and lower-medium are employees in the public and civil services whose regular minimum average monthly earnings or income is between ₦30,000 and ₦115,735 (about \$75 - \$293) and are regular contributors to the National Housing Trust Fund (NHTF).

**Table 1: Participants’ responses/opinions on questions relating to development models in scalogram analysis**

S/N	Development Models or Parameters	NoP	Summated/Likert’s-type 5-point scale, Number of responses and scores									
			SA (5)	A (4)	UD (3)	D (2)	SD (1)					
1	Tenure	7	4	20	3	12	0	0	0	0	0	0
2	Delivery agent	7	1	5	1	4	5	15	0	0	0	0
3	Stakeholders	7	4	20	2	8	1	3	0	0	0	0
4	Target groups	7	3	15	4	16	0	0	0	0	0	0
5	Delivery strategies	7	3	15	4	16	0	0	0	0	0	0
6	Housing needs assessment	7	4	20	1	4	1	3	1	2	0	0
7	Financial	7	3	15	4	16	0	0	0	0	0	0
8	Accessing land for development	7	3	15	4	16	0	0	0	0	0	0
9	Management & maintenance	7	1	5	2	8	4	12	0	0	0	0
10	Performance agreement	7	1	5	2	8	3	9	1	2	0	0
11	Cooperative	7	1	5	1	4	4	12	1	2	0	0
12	Community participation	7	1	5	1	4	4	12	1	2	0	0
13	Performance quality	7	0	0	1	4	1	3	5	10	0	0
14	Design considerations	7	5	25	2	8	0	0	0	0	0	0
Cumulative Total		98	42	170	33	128	14	63	9	18	0	0

Source: Author’s Computations

SA: strongly agree; A: Agree; UD: Undecided; D: Disagree; SD: Strongly Disagree; NoP: No. of participants

The prospective applicants from this target group constitute the possible beneficiaries of not exceeding 40% of any designated social housing scheme provided. The medium and high prices houses are for employees in the organised

private sectors, public and civil services, whose regular minimum average monthly earnings or income is above ₦115,735 but less than ₦197,500 (about \$293 - \$500) and are regular contributors to the NHTF. The prospective applicants from this target group constitute the possible beneficiaries of not exceeding 60% of any designated social housing scheme provided. The panel also identified private social rental and commercial housing development model as components of the 60% of any designated social housing scheme provided, in which prospective applicants from the organised private sectors could benefit from as rent-to-own and/or outright ownership schemes in the proportion of 30%:70% respectively.

### **Stakeholders model**

The panel underscores the importance of stakeholders in the development of sustainable social housing delivery in Nigeria. It identified and agreed on the relevance of Government's MDAs like Ministry of Housing, Ministry of Works and Infrastructure, Ogun State Housing Corporation, Ogun State Property and Investment Corporation (OPIC), Gateway Holdings Limited (Property section), Works Departments in the existing 57 Local Government Areas (LGAs) and Local Council Development Authorities (LCDAs) of Ogun State, especially in the areas of administrative, regulatory functions, coordination and communication schedules through the creation of awareness and enlightenments on pre-conditions or eligibility requirements, process, procedures, duties and responsibilities; obligations, sanctions amongst other matters connected therewith and related thereto. Their roles should also include publicity and mobilisation of prospective participants and stakeholders; providing specific financial supports, land or land banking finance and land preparation. The roles of NGOs like the registered group formations or associations in the form of community development associations (CDAs), cooperative societies, civil/public service, trade unions; civil societies' organisations, faith-based organisations, professional associations, building materials manufacturers' associations, consumers/end-users and general public were noted to be apt. The importance of their roles cannot be overemphasised, especially in the areas of rights, obligations and responsibilities; needs assessments and development; sensitization, coordination and feedbacks to government and financiers.

### **Delivery strategy model**

Having noted several stakeholders and the possibilities of harnessing and deploying their human, financial and material resources to drive and develop social housing agenda, the panel came to conclusion on the need to encourage the consolidation of the plethora of groups' actions in housing delivery under a centrally coordinated delivery agent to be designated as Social Housing Mandates Association (SHMA). The panel came to a position that, the SHMA should be saddled with the responsibilities of engaging, collaborating and coordinating inputs or involvements of private developers, investors, financiers, Governments' Ministries, Departments, Agencies (MDAs), registered group formations and associations like Nigeria Labour Congress (NLC), Trade Union Congress (TUC), Academic Staff Union of Universities (ASUU), Academic Staff Union of Polytechnics (ASUP), Nigeria Union of Teachers (NUT), Senior Staff Association of Nigeria Universities/Polytechnics (SSANU/SSANIP), Non-academic Staff Unions (NASU) and others in pursuance of the social housing agenda. SHMA is therefore, expected to operate as coordinating organ under the Private-Public Participation



arrangement and as a not-for-profit private institution for the public good and within the ambience of affordable open-market economy.

### **Tenure model**

The tenure models identified and adjudged relevant by the panel are leasehold tenure model for a period of 99 years in line with the extant Land Use Decree (LUD) of 1978 and Land Use Act (LUA) of 2004 as amended. The social rental tenure model for the low-medium income groups; the private social rental and commercial housing development tenure model, which are further stratified for the benefit and accessibility of prospective applicants with regular monthly income who are either in the civil or public service employment, or in the organised private sector employments, the medium and high-income groups too are inclusive.

### **Housing needs assessment model**

The panel identified the participation of the private developers in the housing sector as strictly a business venture and had not in any way attempted to mitigate the housing problem of the low-income group. This position corroborates Olanrele et al. (2018) that, only the medium and the high-income groups can afford their housing products. It was recognised that, though the government had been making concerted efforts to improve the housing situation in the country, the operating policies, programmes and projects are not pro- social housing development. The panel was unanimous in stating that, housing supply in Nigeria is inadequate, which agrees with the UN assertion of 17 million estimated deficit and acknowledged government, private individual, corporate organisations and related group formations as the major players in the development of housing in Nigeria (Olanrele et al., 2018). It was similarly agreed upon that, there is a huge gap between housing demand and supply, which underscores the need for the development of template and the conduct of survey research towards the generation of comprehensive data for the formulation of social housing delivery policies, programmes and projects.

### **Land access model for development**

Access to land for the development of social housing are available across the 57 LGAs and LCDAs of Ogun State, which is through release of public land under the extant LUD, 1978 and LUA, 2004 (as amended) by acquisition with or without compensation or by expropriation, land adjustment or land capturing and pooling or assembly. It can also be by unlocking serviced idle land or by transforming undeveloped land for the public good or overriding public interest and for private social housing projects at subsidised rate or value. Such land can then be designated and physically delineated into layouts or development plans, possessed and use for social housing delivery that would be driven by social responsibility. The social housing scheme should essentially be mixed-development, comprising below-the-market-price or subsidised incremental social rental, rent-to-own, private ownership and commercial types of developments. Other model options for accessing land include group acquisition, ownership and documentation of land by employers or cooperative societies for and on behalf of individual members of such formations, which need to be encouraged by the government. There is also the need to review the extant Land Use Act towards making the process of registering land titles, obtaining Governor's consent and secured-tenure

less cumbersome or without bureaucratic encumbrances and without heavy taxes, levies, rates and fees.

### **Financial models for social housing projects, incentives and interventions**

The most attractive, relevant and applicable financial models identified and considered by participants in the focus group discussion (FGD) for the development of social housing projects are State Budgetary Finance Commitments (SBFC) with initial equity offers on commercial components of social housing projects (SHPs) as social responsibility; Designated Consolidated Housing Fund (DCHF) for SHPs through contributions from National Housing Trust Fund (NHTF), Federal Mortgage Bank of Nigeria (FMBN), group formations like CDAs/Unions/Associations or Cooperative, Private Mortgage Institutions and donors/donor agencies. These models can be guaranteed by government's buy-back finance and regulatory framework or guidelines to engender trust, confidence and interest in the participants/investors. The FGD also observed the inherent challenges of low earnings, savings and low disposable income for housing; loop-sided risk sharing, economic, policy and political instability; non-commercial viability and lack of political will to effectively and efficiently drive housing supply.

Findings further revealed that, the determination of contributors' affordability and eligibility to access NHTF credit facility depends on the respective contributor's years-left-in-the-service or remaining years expected in active employment which, must not be less than twenty years. The panel agreed with the position of Jolaoso et al. (2012) that, there is the need for upward review of salaries for workers (especially for the low-income earners) to enhance contributors' affordability and eligibility status towards facilitating their access to credit/loan facility for rentals, home acquisition or ownership through NHTF or mortgage.

### **Design considerations and typologies of social housing**

Findings from the FGD show that, in making the delivery of social housing projects effective, consideration must be given to the design of house typologies within the minimum allowable planning, design and development standards. Attention should be given to the socio-economic, cultural, demographic characteristics and aspiration of the prospective end-users through the provision of functional spaces (like 1-3 bedroom dwellings) with capacity to expand on incremental basis; provision of basic amenities and infrastructure based on available disposable fund for SHPs; possibility of integrated densification with abutting land use and public spaces to create more dwelling units within the same plots-area coverage and minimal vehicular-pedestrian conflicts. The use of available indigenous building materials and manpower as avenue for job creation and economic enhancement are necessary factors.

## **PROPOSAL ON PILOT SOCIAL HOUSING SCHEME**

For the proposed Pilot Social Housing Scheme in Abeokuta, Ogun State, Nigeria, (Figures 3-7 and Table 2) are presented as demonstrable solution towards increasing the number of existing dwelling units, that will be accessible, affordable, acceptable, replicable and self-sustaining to the target-groups of low, lower-medium and medium income population in Ogun State. The following critical assumptions were made with respect to the proposed design and typologies.

- i. The scheme shall be driven by the government as a demonstration of her commitment to social responsibility and public good
- ii. Provision of starter-core (twin) dwelling units of one (1) bedroom each per unit of about 80m<sup>2</sup> each on a plot of about 540m<sup>2</sup> area coverage. Thus, two (2) dwelling units of 160m<sup>2</sup>/plot of 540m<sup>2</sup> as against the existing situation of a dwelling unit/plot of 540m<sup>2</sup>
- iii. The physical development plan or masterplan shall be based on the concept of densification, while the design and construction of the dwelling units shall be incremental basis (starter-core and/or shelter types)
- iv. The scheme shall be for rental and ownership at prices between ₦1,580,000.00 - ₦4,740,000.00 (\$4000-\$12,000) per dwelling unit.
- v. Prospective beneficiaries or eligible individual or corporate shall essentially be in compliance with the NHTF requirements.
- vi. Prospective individual beneficiary or eligible individual shall have opportunity of accessing mortgage credit/facilities of up to ₦5 million (\$12,658.23), while the prospective corporate beneficiary or eligible corporate and private sector entities shall have opportunity of accessing mortgage credit/facilities of up to about ₦10million (\$25,316:46) for the components directly relating to Social Housing Projects only (NHTF, 2005 and FMBN, 1993).

**Table 2: Achievable result of the proposed social housing scheme for the study area of Laderin Workers Estate, Abeokuta comprising 217 plots on 17,360sqm area coverage with a 100% increase in the number of dwellings over and above the existing dwelling units.**

S/N	Descriptions items	Existing Situation		Proposal	
		Number	Sq.m/dwelling	Number	Sq.m/dwelling
1	Total Plots	217	117,180sqm	217	117,180sqm
2	Average Plot size	1	15 x 36 m	1	15 x 18m
3	Average Plot Area coverage	1	540 sqm	1	270 sqm
Dwelling Typologies (Prototype Incremental Development: 1- 3 Bedrooms)					
4	1- Bedroom	86	80sqm	172	80sqm
	2- Bedroom	54	80sqm	108	80sqm
	3- Bedroom	77	80sqm	154	80sqm
5	Estimated total study area coverage	217	17,360sqm	434	17,360sqm
6	Estimated Households Size (@ 6 Person per Dwelling)	1302	N/A	2604	N/A
7	Shops/commercial/communal	nil	-	9	
8	Parks/green/Recreation	Yes	Decentralised	3	Grouped and Decentralised
9	Schools, health, etc,	Yes	Private and substandard	1	

Source: Author's Fieldwork

- vii. Delivery strategy models are by public-private partnership initiatives.

- viii. Participation of NGOs/CDAs/Consumers in the needs 'assessments, project delivery, maintenance and management.
- ix. The target-groups are the civil/public service workers at the low and lower-medium income bracket for the social rental scheme (40%) and medium and high in civil/public and organised private sectors for private social rental and ownership comprising the balance of 60% in the proportion of 30:70 respectively.
- x. Delivery Agent Model shall be a Not-for-Profit Private Institution as Social Housing Mandates Association (SHMA) for public good within the notion of affordable open-market economy and operate as Coordinating Organ of the PPP.
- xi. The Social Housing Mandates Association (SHMA) shall engage, collaborate and coordinate inputs of private developers/investors, financiers, and other stakeholders.
- xii. The Financial Model for the Project is expected to be from State Budgetary Finance commitments with initial equity offers on commercial components of SHP; Donors/donor agencies; Designated Consolidated Housing Fund for SHP in respect of contributions from NHTF/FMBN/CDAs/Unions/Associations/Cooperatives; Private Mortgage Institutions guaranteed by government framework and guidelines through buy-back finance guarantee.
- xiii. The Management and Maintenance Model shall be participatory model in the decision making and taking processes through involvement of the Social Housing Mandates Association (SHMA), CDAs, residents/end-users, general public and the designated regulatory organ; formulation of unambiguous and context-specific tenancy/landlord and management and maintenance agreement manual. The Ministry of Housing shall be the regulatory, monitoring and evaluation organ, who shall register interests under Social Housing Mandates Association (SHMA) and shall set guidelines/framework for tenants/landlord agreement manual, standard of operations, monitoring, evaluation and control; and define rights, privileges, obligations, roles, duties, sanctions and rewards.

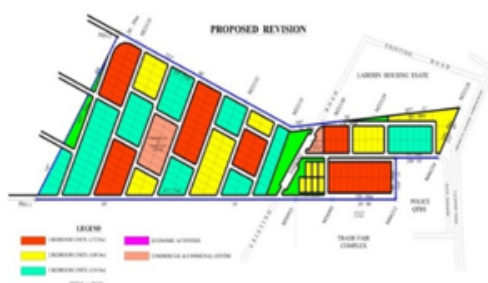

Figure 3: Revised Site Layout to accommodate more dwelling units, basic socio-economic facilities and infrastructure.

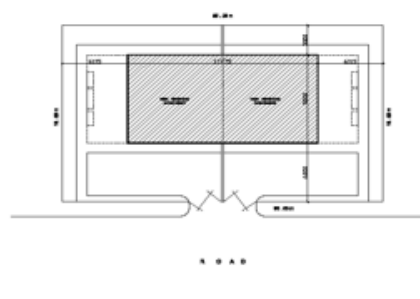

Figure 4: Revised Site Plan with two (2) dwelling units as against the existing one (1) dwelling unit per plot of 540m<sup>2</sup>.

## Dwelling typologies with prototype incremental development

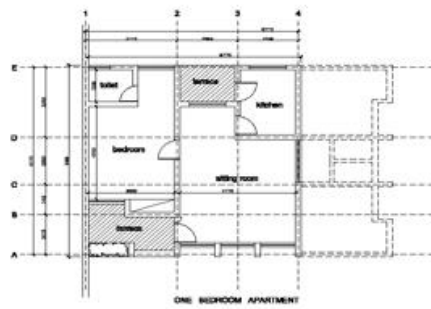

Figure 5: Typical Floor Plan of one (1) with area coverage of 80m<sup>2</sup> as the starter-core of development, which can further be expended by additional bedrooms.



Figure 6: Approach and other views

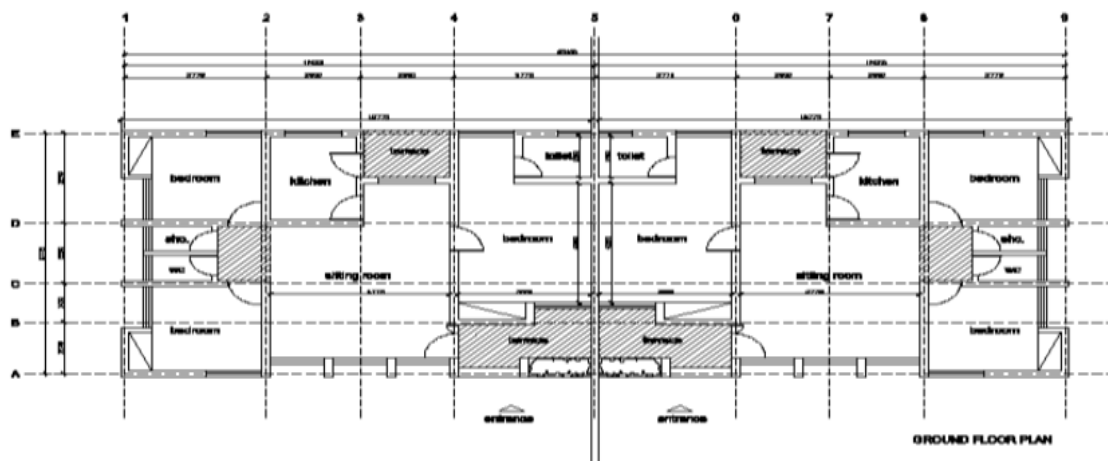

Figure 7: Typical Floor Plan of a fully developed twin-3-bedroom dwelling unit per plots of 540 m<sup>2</sup>

## CONCLUSIONS

This study has examined the housing inadequacy and demonstrated that Social Housing scheme(s) can be part of solution to solving the housing supply challenges in developing country like Nigeria. From the findings, it is suggested that massive review of all relevant and subsisting housing policy and Acts, such as: NSITF, 1993; FMBN, 1993; NHTF, 2005, National Housing Policy (2012) be carried out to succinctly accommodate and effectively integrate shades of SHP models; as well as to provide for better compensation mechanism and protection against negative effect of political instability and manipulations. This will help in the development of SHPs operational guidelines or manual that will in turn lead to the establishment of realistic repayment-default prevention and control mechanisms; formation of organised Social Housing Associations; and access to affordable land and mortgage credit facilities.

It is also pertinent for the government to offer and grant buy-back guarantee or pay-off option while collaborating with stakeholders in re-financing or re-capitalising PMIs and FMBN schemes to accommodate lower interest rate payment. This will engender risk-sharing platform, stimulate trust and public confidence that will in turn promote and mobilise voluntary participation of investors, private

developer and other stakeholders towards the delivery of SHPs. The study foresees SHP as an efficient and effective solution for increasing the housing supply, especially for the target-groups in the urban cities. Its acceptance, viability and participation are largely driven by social responsibility, ability and willingness to pay, which can be made more effective through PPP while the government plays transitory roles from provider to regulator as social responsibility or right.

## REFERENCES

- Addo, A. I. (2014). Urban Low Income Housing Development in Ghana: Politics, Policy and Challenges. <http://www.researchgate.net/publication/262314907>
- Ayala & Geurts (2013), Course handbook and curriculum for Postgraduate Diploma Programme on developing social housing projects (DSHP), Institute for housing and urban development studies, Erasmus University, Rotterdam, Netherlands, pp.3-5
- Boamah, N. A. (2014). Housing Policy in Ghana: The Feasible Path. *Ghana Journal of Development Studies*, 11(1).
- Czischke, D. (2017). Collaborative housing and housing providers: towards an analytical framework of multi-stakeholder collaboration in housing co-production. *International Journal of housing policy*, pp.1-27
- Daramola, S. A. (2004). Private, Public Participation in housing delivery in Nigeria. Paper presented at the Royal Institute of Surveyors Business Luncheon, Lagos, Nigeria.
- Federal Government of Nigeria (1991). *The National Housing Policy*. Lagos: Federal Ministry of Works and Housing. Abuja.
- Federal Republic of Nigeria (2002). Government white paper on the report of the Presidential Committee on housing and urban development, Abuja: Federal Republic of Nigeria
- Federal Republic of Nigeria (2006). *Housing sector reforms*. Federal Ministry of Information and National Orientation, Abuja, Nigeria
- Gilbert, A. (2004). Helping the poor through housing subsidies: lessons from Chile, Colombia and South Africa. *Habitat International*, vol. 28, pp. 13-40.
- Gilbert, A. (2011). Policy guide to rental Housing in developing countries, Quick policy guide series. UN-Habitat, Nairobi and Cites Alliance.
- Ibem, E. O. (2011). The contribution of public-private partnerships (PPPs) to improving accessibility of low-income earners to housing in southern Nigeria. *Journal of housing and built environment*, 26(2), pp.201-217
- Ibem, E. O. (2011a). Evaluation of public housing in Ogun State, Nigeria. (PhD thesis), School of Postgraduate Studies, Covenant University, Ota, Nigeria, April 2011
- Jolaoso, B. A. (2017a). Implications of informal housing development in Abeokuta, Nigeria, (PhD Thesis), Department of Architecture, Federal University of Technology, Akure, Nigeria, pp. 21-69
- Jolaoso, B. A. (2017), Proposed social housing agenda for Ogun State, Nigeria: A project proposal presentation, Postgraduate Diploma Course on Developing Social Housing Projects (DSHP), Institute for housing and urban development studies, Erasmus University, Rotterdam, Netherlands, Unpublished, 6-24th November, 2017

- Jolaoso, B. A., Arayela, O., Taiwo, A., & Folorunso, C. O. (2017). Emergence of informal housing: implications for development of low-cost housing delivery strategies in Abeokuta, Nigeria. *International Journal of Innovative Research & Development*. March, 2017, Vol 6, Issue 3, p191-198. [www.ijird.com](http://www.ijird.com). ISSN 2278 – 0211 (Online)
- Jolaoso, B. A., Musa, N. A., & Oriola, O. A. (2012). National housing trust fund and low-income housing delivery in Nigeria: A discourse, *Journal of Emerging Trends in Economics and Management Sciences (JETEMS)* 3(5): 429-438, © Scholarlink Research Institute Journals, 2012 (ISSN:2141-7024), [jetems.scholarlinkresearch.org](http://jetems.scholarlinkresearch.org)
- Klynveld Peat Marwick Goerdeler (KPMG Report, 2012), a discussion paper on the options to improve the supply of quality housing, Victorian Department of human services, April, 2012, [www.kpmg.com.au](http://www.kpmg.com.au)
- Mitlin, D. (2011). Shelter Finance in the Age of Neo-liberalism. *Urban Studies*, 48(6), 1217-1233. doi: 10.1177/0042098010375325
- Moskalyk, A. (2008). The role of public-private partnerships in funding social housing in Canada, (CPRN Research Report; September, 2008). Ottawa, Canadian Policy Research Networks. [http://rcrpp.org/documents/50550\\_FR.pdf](http://rcrpp.org/documents/50550_FR.pdf)
- Moss, V. (2003). Understanding the reasons to the causes of defaults in social housing sector in South Africa. *Housing finance International*, pp.20-26
- Ogun State Ministry of Housing (2008). Housing delivery in Ogun State, Nigeria, In Jolaoso, B. A. (2017a). Implications of informal housing development in Abeokuta, Nigeria, (PhD Thesis), Department of Architecture, Federal University of Technology, Akure, Nigeria, pp. 21-69
- Olanrele, O. O., Jolaoso, B. A., & Adegunle, T. O. (2018). Towards sustainable housing supply in developing Africa Cities. *African Journal of Applied Research* Vol. 4, No. 2(2018), pp. 16-31 <http://www.ajaronline.com>  
<http://doi.org/10.26437/ajar.04.02.2018.02>. ISSN: 2408-7920. Arca Academic Publishers.
- Peppercorn, I., & Taffin, C. (2013). Rental housing, lesson from International experience and policies for emerging markets. World Bank: Washington DC.
- Priemus, H. (2010). Social housing as a transitional tenure? Reflection on the Netherlands, New housing memorandum, 2000-2010, In: *Housing Studies*, vol.16 (2), pp. 243-253.
- SHF/Development Works (2004). Tenure options for social housing projects. Social Housing Foundation Research Series, Development works: Johannesburg, South Africa.
- Social Housing Foundation (2010). A toolkit for social housing institutions. Johannesburg, South Africa, third edition. <http://www.shra.org.za/resource-centre/toolkit/shi>
- UN-Habitat (2011). Housing the poor in African Cities, rental housing: A much neglected housing option for the poor. Quick policy guide for policy makers. UN-Habitat, Nairobi and Cities Alliance.
- Van der Moolen, J. (2015). The Dutch experience post-vestia: Lesson from Netherlands. In: *Housing finance International*, Autum, 2015, pp. 39-43







---

# DIURNAL TEMPERATURE CHANGES AND PHYSIOLOGICAL EXPERIENCE: CASE STUDY ANALYSIS OF INDOOR CONDITION IN A SCHOOL ENVIRONMENT IN NIGERIA

Eludoyin Oyenike Mary<sup>1</sup>

*Department of Geography and Planning Science, Adekunle Ajasin University, Akungba-Akoko, Ondo State, Nigeria*

Studies have shown that school residence and hostels thermal environments could impact on thermal comfort and learning performance. Majority of current researches on the school indoor thermal environment have been focusing on urban areas, but notably little research has been conducted on rural and medium-size urban schools. The present study characterized the daytime thermal condition (in terms of the ambient air temperature change) in a University campus in southwest Nigeria, and examined the perception of students in the halls of residence on thermal condition and their strategies for coping with extreme thermal cases. Ninety-eight (98) copies of a set of structured questionnaire were administered, and the weight and body temperature of the respondents were measured alongside with the ambient temperature and relative humidity at morning and afternoon sessions, making a total of 196 sessions. Diurnal thermal range varied between 32.4°C and 35°C in the morning and between 26.5°C and 30.9°C in the evening. Thirty-five (35%) percent of the subjects (young male and female students, aged 18 – 45 years) associated thermal discomfort with restlessness and profuse sweating but 13% did not feel any significant thermal stress within the study period. Also, effects of thermal stress varied diurnally; whereas 65% of the subjects experienced heat rashes and headache in the evening and afternoon, respectively, about 10% experienced profuse sweat and chest constriction in the morning. Lastly, perception of thermal stress varied with room temperature, subjects' body weight, period of the day and ventilation. The study concluded that thermal discomfort in the area is influenced by indoor and outdoor atmospheric conditions as well as subjects' physical and physiological characteristics.

Keywords: indoor characteristics, perception, physiology, temperature, thermal stress

## INTRODUCTION

### Background to the study

The school thermal environment is known to impact learning from primary to tertiary institutions (Liu et al., 2017; Jiang et al., 2020; Guevara et al., 2021). The school's residential and classroom environment are examples of indoor thermal environment that forms an important part of the consideration for satisfaction,

---

<sup>1</sup> baynick2003@yahoo.com

globally, probably because people are likely to spend averagely more than 90% of their time indoors, and students would spend about 30% of their lives in schools (De Giuli et al., 2012; Korsavi, et al., 2021).

Typical human body maintains a core temperature within a narrow range of 37°C but humans tend to react to changes in environmental temperature with alteration in body conditions and some other physiologic factors (Subedi, 2021). Appropriate indoor conditions are therefore necessary, especially for schools which house people of different ages and of different economic, social and ethnical background since studies have revealed that the factors affecting thermal comfort for adults, infants, children and adolescents may be dissimilar (e.g. Kadlec, 2021). Apart from ages and experience, factors such as clothing type, metabolic rate and the activity levels are not the same for optimal conditions between the two groups. On the other hand, many schools in developing countries are usually not provided with atmospheric conditioning systems, due to economic reasons. Here, the indoor temperature, humidity, wind speed and other parameters would vary along with the outdoor parameters, which could greatly affect students' psychological experience (Liu et al., 2020).

Thermal comfort is the condition of the mind that expresses satisfaction with the thermal environment (Wang & Liu, 2020). It is also the absence of discomfort, when a person feels neither too warm nor cold (Sansaniwal et al., 2020). Many people would feel comfortable at room temperature (20-22°C) but variations occur with different individuals and personal attribute level, including activity level, clothing, and humidity (Lee & Ham, 2021). In many schools, students may not be able to open or close windows to change their status randomly at will, and classrooms in developing countries often have high density of students, such that there can be a large variation in the thermal sensation between the students in classrooms, halls of residence and other people in the community (Al-Khatri et al., 2020; Munonye, 2020). Perception on thermal comfort is typically defined in terms of the physical, psychological sensations generated by the thermal environment stimuli, activity, clothing, experience and human expectation (Aulicems, 1998).

Main factors that influence thermal comfort are those that determine heat gain and loss (including metabolic rate, clothing insulation, air temperature, mean radiant temperature, airspeed and relative humidity), psychological factors (such as individual expectations and responses also affect thermal comfort; Schweiker et al., 2018). Thermal comfort may vary based on the location of the environmental condition; i.e. indoor or outdoor environment. Indoor spaces are important and contribute greatly to livability and vitality (Hakim et al., 1998); people are also not directly exposed to sunshade, changes in wind speed and other characteristics in the outdoor environment but are affected by the interaction between the medium of their building materials, and available infrastructure in the rooms and immediate environment. The relationship of physical parameters to physiological response of humans, however remains poorly understood (Hartmann & Bung, 1999).

A number of bio-meteorological indices have been developed to describe human thermal comfort levels. Most of these indices are based on the assumption that people's exposure to an ambient climatic environment has enabled them to reach thermal equilibrium overtime (Nagano & Horikoshi, 2011). Examples of the indices

include the Predicted Mean Vote (PMV) (Zhang & Lin, 2020) which predicts the mean thermal response of a large population of people. It is often measured on a seven-point scale (hot, warm, slightly warm, neutral, slightly cool, cool, and cold) or Predicted Percentage Dissatisfied Index (PPD), which is defined as the quantitative prediction of the percentage of thermally dissatisfied people at each PMV value. The PPD was originally developed as an indoor thermal comfort index, but has also been commonly adopted in outdoor thermal comfort studies in which a large group of people are being surveyed (Liu et al., 2020). Similar subjective method is the Physiological Equivalent Temperature (PET) (Davtalab et al., 2020) which is the air temperature at which, the human energy budget is maintained by the skin temperature, core temperature and sweat rate equal to those under the conditions to be assessed (Klous et al., 2020). The indices translate the valuation of a complex outdoor climatic environment to a simple indoor scenario on a physiologically equivalent that can be easily understood. The subjective indices have been combined with climatic data to assess human thermal response to the local environment (Elnabawi & Hamza, 2020).

### Concept of thermal comfort and heat stress

Human thermal comfort is the state of mind that expresses satisfaction with the surrounding environment according to ASHRAE standard 55 (Arif & Yola, 2020). One of the most important properties of the human body is to keep constant the internal body temperature (37.5°C); also known as homoeothermic property. Zhang & Wang (2020) described human beings as homoeothermic who need to maintain their body temperature by thermoregulatory and/or behavioral adjustments to adapt to changing environments. Thermal comfort often depends six fundamental factors that are clothing, air temperature, radiant temperature, humidity, air movement, and metabolic heat (Bennetts et al., 2020), and these factors have been described as the determinants of human thermal balance [1]:

$$M \pm W = S \pm R \pm C \pm K - E \quad (1)$$

Where

M = metabolic heat production,  
 W = energy consumed/absorbed by mechanical work,  
 E = heat transfer via evaporation  
 R = heat transfer by radiation,  
 C = heat transfer via convection,  
 K = heat transfer via conduction, and  
 S = heat storage

The human heat balance suggests that heat input source varies with the ambient temperature, such that heat source within the body is often the one that is metabolically generated in normal climatic conditions (Luo, 2020). In uncomfortable conditions, when the ambient temperature is greater than skin temperature, the heat input is combined by heat transfer from the environment with that generated by metabolic activities within the body. Heat is transferred between the body and the surrounding environment; either as dry heat transfer via conduction (between solid surfaces contacting with each other), convection (between a solid surface and its surrounding fluid) and radiation (via emission or absorption of electromagnetic waves) or as sweat evaporation (heat transfer via

respiration) (Fig. 1). The heat storage ( $S$ ) in the equation reflects the thermal debt situation of the body, such that when the body is in a thermally neutral state, it ( $S$ ) is zero; it becomes positive when the heat loss is less than the heat production, which causes rise in body temperature. On the other hand, the  $S$  will be negative if heat loss is greater than the heat production, and this may cause a fall in body temperature.

Heat stress, the overall effect of excessively high temperature that disturbs the body's thermal comfort and cold stress, a condition marked by abnormally low, internal body temperature which develops when the body loses heat faster than it produces it, are the extremes of thermal comfort (Di Napoli et al., 2020; Tomczyk et al., 2020).

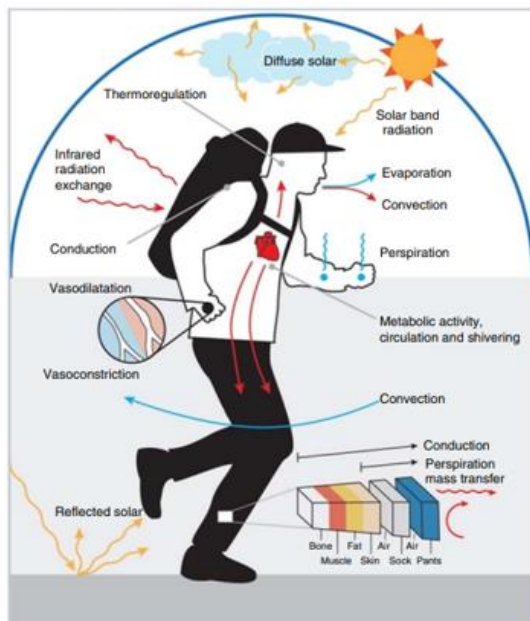

Figure 1. Heat transfer between the human body and surrounding environment (Source: Zhang & Wang, 2020).

For steady exposure to cold and warm environments, thermal comfort and neutral temperature sensations lie in the range for physiologic thermal neutrality (28°-30°C), in which there is no physiologic temperature regulatory effort.

Discomfort increases more rapidly below 28°C than above 30°C, while thermal sensation for both heat and cold increases rapidly on each side of the neutral. Discomfort correlates best with lowering average skin temperature towards cold environments and with increased sweating towards hot environments. In general, discomfort is associated with a change of average body temperature from 36.5°C. The same conclusion follows for transient changes when the subject goes from comfortable to uncomfortable, neutral to cold, and neutral to warm. However, cold stress would actually occur in cold environment just as heat stress would occur in hot environment. If a body cannot maintain thermal equilibrium, the amount of heat gained by the metabolism cannot offset the amount of heat lost from the body to the environment. If the equilibrium of the body's core temperature is maintained, heat or cold stress will not accumulate. However, the body seldom maintains a precise thermal equilibrium.

### **Awareness about the impact of weather on human physiological experience**

Increasing awareness of continued accumulation of greenhouse gases in the atmosphere that is expected to cause an increase in global temperature (Adenuga et al., 2021) has increased the amount of discussions in the field. Much discussed include the impact of climate on the following:

1. heat-related mortality and morbidity (Santamouris & Osmond, 2020);
2. infectious diseases, particularly those that are arthropod-borne (Wu et al., 2021);
3. malnutrition and dehydration from threatened food and water supply (Rosinger & Young, 2020);
4. general public health infrastructural damage from weather disasters and sea-level rise, aggravated by climate-related forced human migration (Bell & Masys, 2020); and
5. tourism and thermal comfort (Zhu et al., 2020).

Most of these researches appear to have been motivated by the potential usefulness of climate information within planning processes for comfort, tourism and recreation. They mostly address bioclimatology as being adjunct to a variety of decision making processes ranging from those related to such things as study of human health, diseases prevalence, development and location of appropriate recreational facilities, or determining the length of the recreation season during which a facility will operate, to those as specific as planning future activities involving personal decisions of when and where to go for a holiday. There has also been interest in the indirect effects of climate. Thus, depending on the weather sensitivity of the human livelihood activity, information gathered through the study of bioclimatology can help in the planning, scheduling and promoting of alternative indoor entertainment facilities. It can also be used to condition tourists' expectations of climate at certain locations (Pérez & Cantos, 2020).

### **Research problem and objectives**

Given the increased concerns of the effects of thermal comfort indices on man has translated into research, many researchers have attempted to understand the views, severity and implications of these effects as well as seeking to understand how people cope with them (Antoniadis et al., 2020). An understanding of the nature of thermal comfort index of a region or area is important. This ensures a better understanding of the thermal conditions and comfort of the people. The study on the University environment is underpinned by the assumption that ivory towers should serve as template from which communities can learn. Students are also characterized by diverse demographic, social and economic background, and as such, understanding their perceptions and feeling under similar climatic conditions encouraged curiosity about varying perceptions and coping strategies, hence this study.

Specific objectives are therefore to examine the perception of a set of systematically selected students on thermal condition in their University (Obafemi Awolowo University, Ile-Ife, Nigeria), characterize the diurnal thermal condition in

the study area and examine prominent coping strategies against thermally uncomfortable weather/climatic condition.

## STUDY AREA

The study area, Obafemi Awolowo University campus in the southwestern Nigeria (Fig. 2), has a population of over 30,000 students and many hundreds of staff (Babatimehin et al., 2020). The area is climatically distinguished by two distinct seasons; wet/rainy and the dry seasons, which is experienced April - October and November-March, respectively. Mean annual rainfall is about 1237 mm. The vegetation is naturally rain forest but now has many areas that are covered by herbs, grasses and light forest due to human interferences. Analysis of the land use pattern suggests that the built-up area of the campus can stratified into Students' residences, Staff quarters, and Administrative and Academic area, which consists of administrative blocks, classrooms, amphitheater and other hall facilities, library, student union building and places for entertainment, recreation and sports.

Students' accommodation facilities (halls of residence) are separated from the Academic and Administrative blocks. Cafeterias and markets are also separated to another section of the University land while staff quarters and an extensive land for agriculture and land/water-related researches are made to occupy a large space on the University campus, as well. The staff quarters contain over 500 housing units for senior academic and administrative staff and more than 30 semi-detached units for junior staff. Junior staff quarters are located towards the end of "Road 7" linking the campus with the city of Ile-Ife via the 'Second Gate'. The staff quarters are well planned with great care; the uniformly consistent and attractive environment, based on the principles of garden city planning features, is planned to give a sense of belonging. The Students halls of residence include, Awolowo, Fajuyi, Postgraduate/Murtala Mohammed, Angola, Mozambique, Moremi, Ladoke Akintola/Sport, Education Trust Fund/ETF and Alumni Halls. Each hall is capable of accommodating between 1,000 and 5,000 students.



Fig. 2. Obafemi Awolowo University, Ile-Ife (Adapted from Babatimehin et al., 2020)

## MATERIALS AND METHODS

The study design was experimental, and data were obtained in two weeks in May 2018. Use of daily data for weather analysis is common and acceptable in climatological researches, since weather is the atmospheric condition for a short

time, a synthesis of which can be used for prediction (Duarte & Sentelhas, 2020). Data used for this study included the ambient air temperature, taken at different period of the day (0800 – 1000 and 1600 – 1800 Local Standard Time, which are peak periods of activities in the University). Data also include responses of a purposively selected participants on feelings, thermal discomfort and coping strategies, as well as their body characteristics. Selected participants were male and female students, aged 18 – 45 years. Responses were obtained from participants in halls of residence, following a multistage procedure;

- Seven halls of residence were systematically sampled, considering gender, level of dominant residents (postgraduate versus undergraduate halls) and location (based on compass direction).
- From selected halls, three blocks of rooms (1st, 50th and 99th rooms) at the upper and lower floors were targeted for even distribution and understanding of thermal conditions.
- In all, a total of 98 copies of questionnaire were administered in the hostels; two (Angola and Mozambique) has only one floor - bungalow buildings.

Air temperature and relative humidity were obtained using handheld thermometer and hygrometer, while perception on using a set of structured questionnaires. Also, a handheld Global Positioning System (etrex version) was used to take the coordinates of the halls of residence and specified locations in the study area. Body temperature of the participants and their weight were measured using clinical thermometer and a mechanical bathroom weight measuring scale, respectively. Results were analysed using isotherms and percentage distribution.

Analysis of the data were achieved using statistical and kriging interpolation in standard statistical software. Specifically, the map was done using PAentological STatitics (PAST 3) while other analysis was achieved using SPSS (IBM 21 version) software.

## **RESULTS AND DISCUSSION**

### **Outdoor and indoor air temperature changes**

Outdoor air temperature varied more in the evening than the morning time across the university campus, and surprisingly the morning time was warmer than the evening time, although the evening time showed more variability (27°C – 30.9°C compared with 32.3°C – 35.2°C) (Fig. 3). Higher outdoor temperature during the morning-time suggests that heat generating activities may be more in the morning than the evening. Students cook more in their hostels, and the movements to attend lectures appear to be at peak in many days. The study period was within the lecture periods of the University, when students often rush to attend classes, and when many practical activities were taking place, outside the halls of residence.



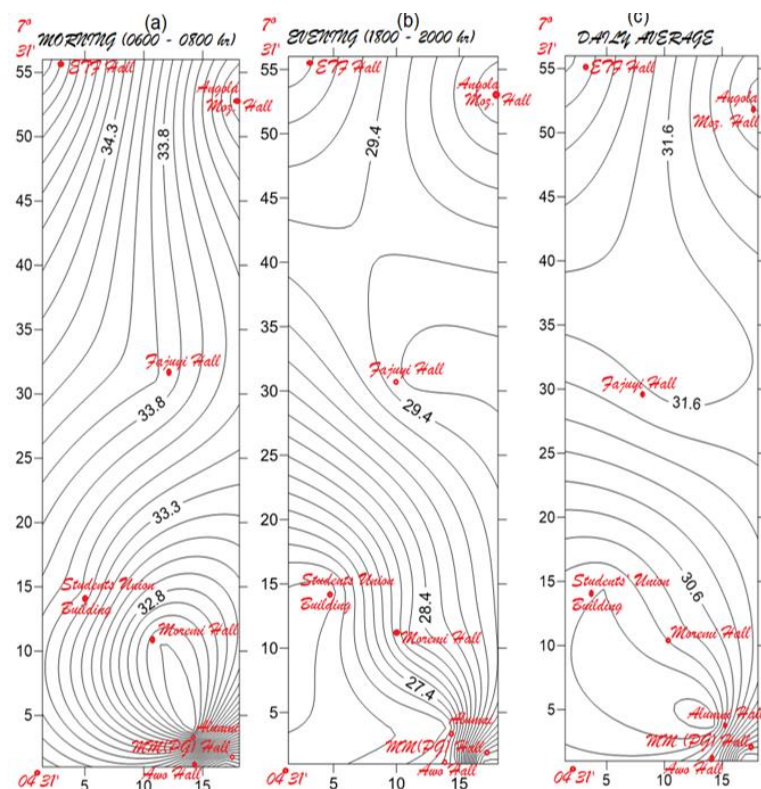

Fig. 3. Time variant and average daily isotherm distribution across the University area

Also, vehicular activities at this period also peaked throughout the university campus unlike in the evening when most of the activities may be concentrated towards the exit gates, when workers leave for their homes. Fig. 3 also shows that areas around the halls of residence had higher outdoor temperature, suggesting an impact of activities in the residential halls of residences. Fig. 4 shows the variation in the mean room temperature across the selected halls. Room temperature appeared to vary with location, that is, the surrounding environment of the halls.

Temperatures tend to decrease as one moved away from one of the halls (although highest at Angola) towards the academic areas in the morning. Angola hall houses 100 level undergraduate students, and the journey to the academic area requires passage through all the other halls, except Ladoke Akintola/Sport and ETF halls. Average indoor temperature however dropped/decreased at Moremi hall. Moremi hall is surrounded by relatively more open space than the other halls, and characterized with extensive grassland.

**Heat condition and perception in the hostel rooms**

Less than average (45.8%) of respondents resided in rooms without fan, and 34.5% were found discussing/chatting at the time of the study. Others were either doing nothing/lying down (resting) will only few (< 7%) were found studying (Table 1). Over 70% described the rooms at the time of the study as either warm or hot (41.2% and 39.1%), probably because the study occurred in the dry season (March 2018). Comparison of the effect of the presence or absence of ventilation (either uncovered, with fan or without a fan) suggest that body temperature tend to be differently modulated by fan and natural air (Fig. 4). The lower than the average human body temperature observed in most of the subjects may be due to local



conditioning, especially the fan and clothing style, which may initiate hypothermia, if it occurs for long (Bradley-Siemens, 2020).

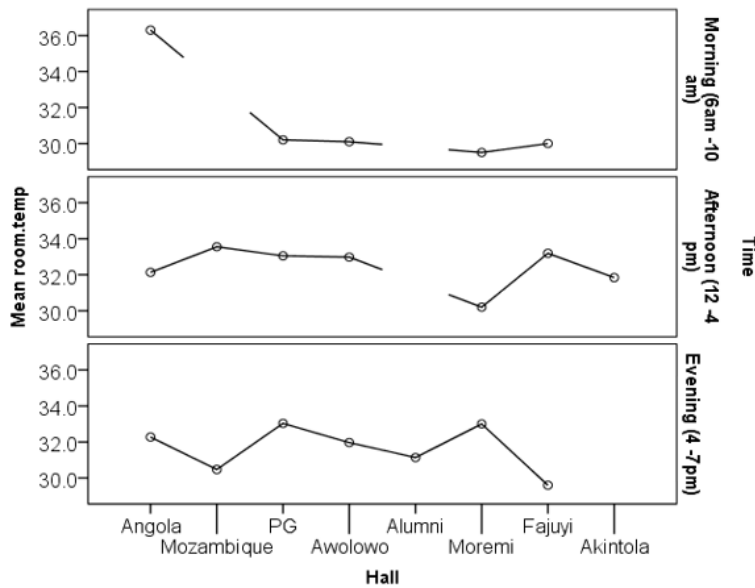

Fig. 4. Mean daily indoor/room temperature across selected halls in the University campus

Table 1 Situation attributes of respondents

Variable	Option	Frequency	Percentage (%)
Gender	Male	122	43
	Female	162	57
Description of location	Partially uncovered	36	12.7
	Room with fan	118	41.5
	Room without fan	130	45.8
Activities at interview	Resting	64	22.5
	Chatting	98	34.5
	Reading	23	8.1
	Sitting	17	6.0
	Watching a movie	10	3.5
	Studying	19	6.7
	Eating	14	4.9
	Cooking	26	9.2
	Working	13	4.6

### Effects of heat

Relatively higher proportion of the participants complained of restlessness in the event of heat surge, others complained of increased level of perspiration or sweating, especially in the afternoon (Fig. 6a). Fig. 6b revealed that many of the

temperature-related sicknesses exhibited temporal/diurnal variations. For example, more cases of tiredness, dizziness and sweating were recorded in the evening while heat rash and headache occurred more in the afternoon. Furthermore, reportage of the effects appears to be gender biased, as majority of the participants that reported dizziness, headache and heat rashes were female while the male participants mostly reported chest constriction, sweating and tiredness (Fig. 6a). Also, majority of those who claimed to sweat much were from the partially covered room and those who were restless were surprisingly from the rooms with fan (Fig. 6b).

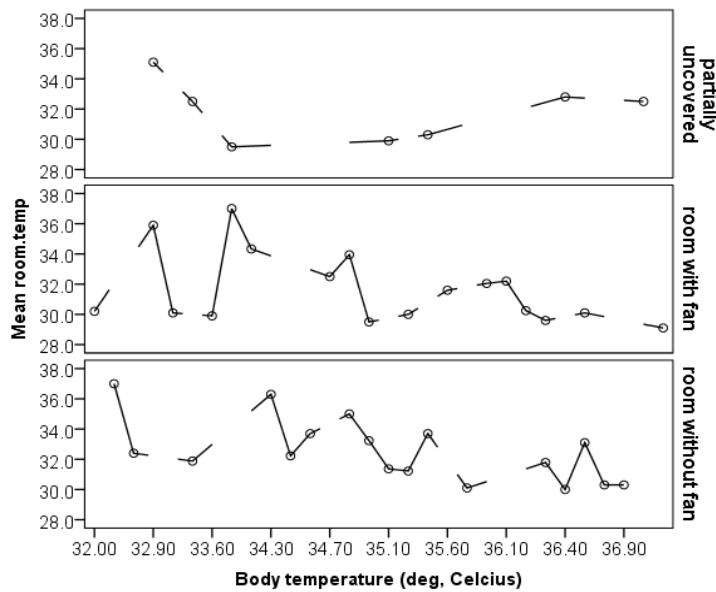

Fig. 5. Change in body temperature with change in air temperature across different environment

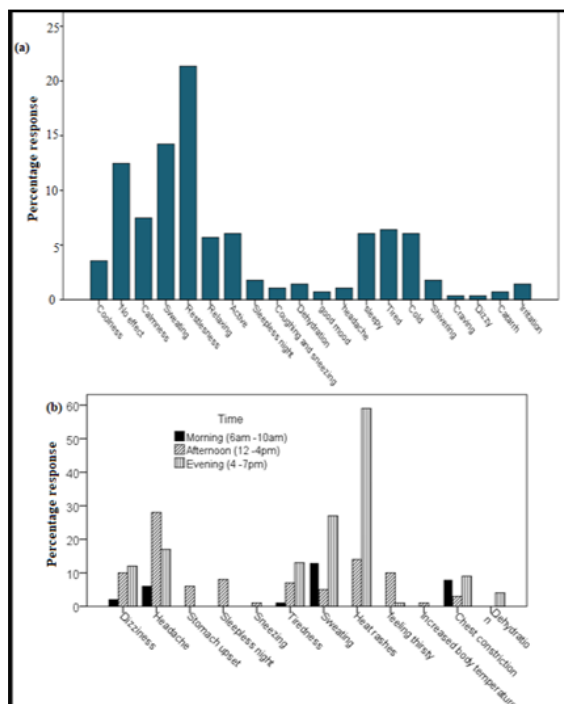

Fig. 5. Reported effects (a) of high temperature and diurnal variations (b)

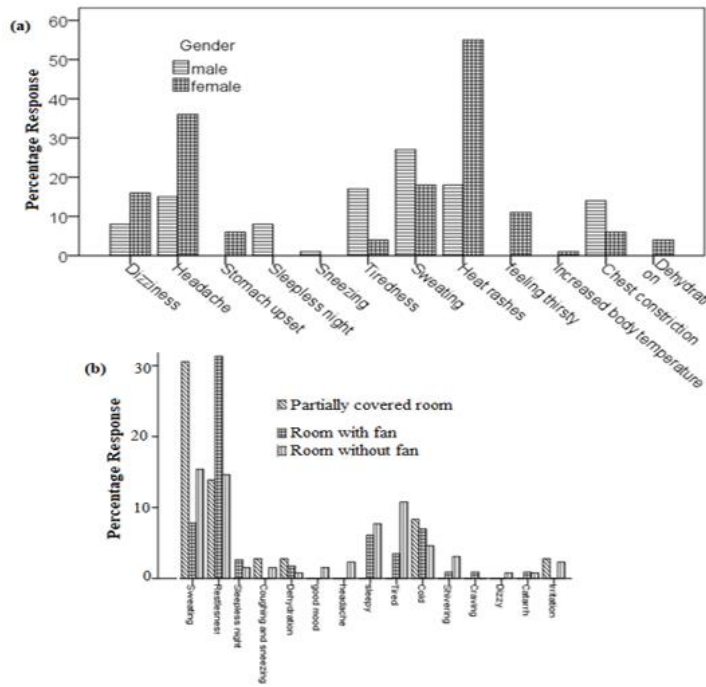

Fig. 6. Perception on the role of gender and room type on physiological feeling

Apparently, no coping strategy was exhibited by the participants other than trying to be active, and or responsive to the prevailing temperature; such as taking shower when it is hot, using cover cloth when it is cold, taking nap, among others (Fig. 7). Given this and other information from majority of the participants, it became almost obvious that knowledge about physiologic climate and coping strategies is shallow.

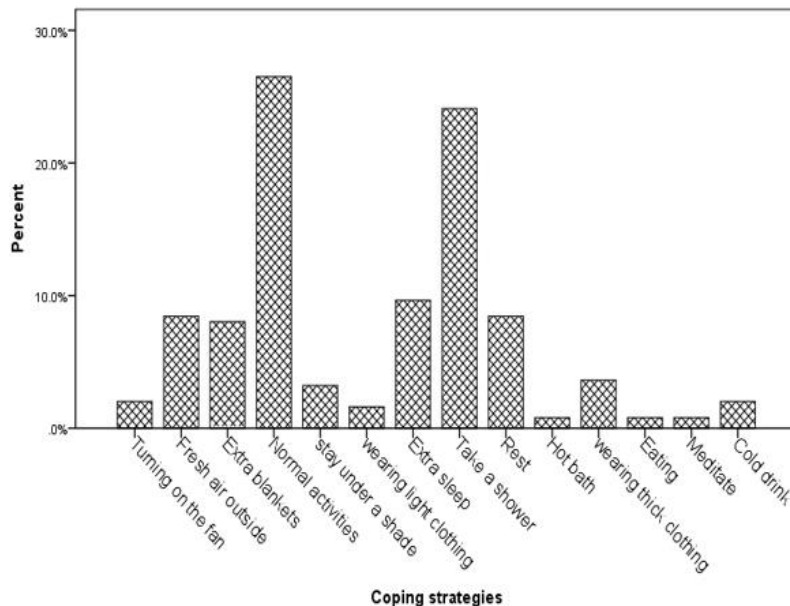

Fig. 7. Coping strategies to extreme heat condition by participants

Many (over 42.2%) of the participants were actually new to the term, thermal comfort, physiologic comfort or bioclimate, and less than 20% considered heat stress a problem that require a major concern in the study area.

## IMPLICATION OF THE STUDY, CONCLUSION AND RECOMMENDATIONS

A number of issues emanating from this study indicate poor knowledge of physiological climatology, human biometeorology and thermal comfort among participants, who were University students at the time of study. The study revealed that surrounding environment, indoor condition as well as personal attributes of subjects are important in the discussion of thermal comfort. The main implication of this study is that accommodation and classroom condition can impact significantly on learning activities. The study is however limited by not correlating the thermal characteristics of the subjects with their academic performances, which might require a strictly controlled environment. Nonetheless, this is a preliminary study, and efforts are on to enlarge the scope of the study to include the perceived resultant variables.

In all, the study also showed the need for better understanding of the role of gender orientation, building materials, ventilation, among other variables that have been shown to be relevant to physiologic or thermal comfort in developed economies, as they relate to the sub-Saharan African countries. More experimental researches in the area of thermal comfort in the region is recommended to improve awareness to the effects of extreme temperature events, such as heat stress, heat stroke, among others. It is hoped that such improved focus on experimental research can improve innovative coping strategies for heat and/or cold stress events in the region.

## REFERENCES

- Adenuga, K. I., Mahmoud, A. S., Dodo, Y. A., Albert, M., Kori, S. A., & Danlami, N. J. (2021). Climate Change Adaptation and Mitigation in Sub-Saharan African Countries. *Energy and Environmental Security in Developing Countries*, 393-409.
- Al-Khatiri, H., Alwetaishi, M., & Gadi, M. B. (2020). Exploring thermal comfort experience and adaptive opportunities of female and male high school students. *Journal of Building Engineering*, 31, 101365.
- Antoniadis, D., Katsoulas, N., & Papanastasiou, D. K. (2020). Thermal environment of urban schoolyards: current and future design with respect to children's thermal comfort. *Atmosphere*, 11(11), 1144.
- Arif, V., & Yola, L. (2020). The Primacy of Microclimate and Thermal Comfort in a Walkability Study in the Tropics: A Review. *Journal of Strategic and Global Studies*, 3(1), 2.
- Babatimehin O. I., Eludoyin, A. O., Ekundayo, O. O., & Ekewere, N. J. (2020) Quality and perception on water use in Obafemi Awolowo University, Ile-Ife, Nigeria, *Interdisciplinary Environmental Review*, 20 (2): 100 – 117,
- Bell, C., & Masys, A. J. (2020). Climate change, extreme weather events and global health security a lens into vulnerabilities. In *Global Health Security* (pp. 59-78). Springer, Cham.
- Bennetts, H., Arakawa Martins, L., van Hoof, J., & Soebarto, V. (2020). Thermal personalities of older people in South Australia: a personas-based approach to develop thermal comfort guidelines. *International journal of environmental research and public health*, 17(22), 8402.

- Bradley-Siemens, N. (2020). Environmental and Situational Injuries/Death Thermal, Chemical, Electrical, Hyperthermia, Hypothermia, and Drowning. In *Veterinary Forensic Medicine and Forensic Sciences* (pp. 225-251). CRC Press.
- Davtalab, J., Deyhimi, S. P., Dessi, V., Hafezi, M. R., & Adib, M. (2020). The impact of green space structure on physiological equivalent temperature index in open space. *Urban Climate*, 31, 100574.
- De Giuli, V., Da Pos, O., & De Carli, M. (2012). Indoor environmental quality and pupil perception in Italian primary schools. *Building and Environment*, 56, 335-345.
- Di Napoli, C., Barnard, C., Prudhomme, C., Cloke, H. L., & Pappenberger, F. (2021). ERA5-HEAT: A global gridded historical dataset of human thermal comfort indices from climate reanalysis. *Geoscience Data Journal*, 8(1), 2-10.
- Duarte, Y. C., & Sentelhas, P. C. (2020). NASA/POWER and DailyGridded weather datasets—how good they are for estimating maize yields in Brazil?. *International journal of biometeorology*, 64(3), 319-329.
- Elnabawi, M. H., & Hamza, N. (2020). Behavioural perspectives of outdoor thermal comfort in urban areas: a critical review. *Atmosphere*, 11(1), 51.
- Guevara, G., Soriano, G., & Mino-Rodriguez, I. (2021). Thermal comfort in university classrooms: An experimental study in the tropics. *Building and Environment*, 187, 107430.
- Hartmann, S., & Bung, P. (1999). Physical exercise during pregnancy—physiological considerations and recommendations. *Journal of perinatal medicine*, 27(3), 204-215.
- Jiang, J., Wang, D., Liu, Y., Di, Y., & Liu, J. (2020). A field study of adaptive thermal comfort in primary and secondary school classrooms during winter season in Northwest China. *Building and Environment*, 175, 106802.
- Kadlec, K. D. (2021). ECMO Simulation in Infants, Children, and Adolescents. In *Comprehensive Healthcare Simulation: ECMO Simulation* (pp. 187-205). Springer, Cham.
- Klous, L., De Rooter, C., Alkemade, P., Daanen, H., & Gerrett, N. (2020). Sweat rate and sweat composition during heat acclimation. *Journal of Thermal Biology*, 93, 102697.
- Korsavi, S. S., Montazami, A., & Mumovic, D. (2021). Perceived indoor air quality in naturally ventilated primary schools in the UK: Impact of environmental variables and thermal sensation. *Indoor air*, 31(2), 480-501.
- Lee, J., & Ham, Y. (2021). Physiological sensing-driven personal thermal comfort modelling in consideration of human activity variations. *Building Research & Information*, 49(5), 512-524.
- Liu, S., Wang, Z., Schiavon, S., He, Y., Luo, M., Zhang, H., & Arens, E. (2020). Predicted percentage dissatisfied with vertical temperature gradient. *Energy and Buildings*, 220, 110085.
- Liu, Y., Jiang, J., Wang, D., & Liu, J. (2017). The indoor thermal environment of rural school classrooms in Northwestern China. *Indoor and Built Environment*, 26(5), 662-679.
- Luo, M. (2020). Adaptive Heating Balance Comfort Model. In *The Dynamics and Mechanism of Human Thermal Adaptation in Building Environment* (pp. 131-144). Springer, Singapore.

- Munonye, C. C. (2020). Thermal comfort assessment of primary school children in a warm and humid climate: a case study of Imo State, Nigeria (Doctoral dissertation, University of Salford).
- Pérez, J. J. M., & Cantos, J. O. (2020). Climatic change and thermal comfort. Effects on the tourism industry in the region of Valencia. *Investigaciones Turísticas*, (20), 1-30.
- Rosinger, A. Y., & Young, S. L. (2020). The toll of household water insecurity on health and human biology: Current understandings and future directions. *Wiley Interdisciplinary Reviews: Water*, 7(6), e1468.
- Sansaniwal, S. K., Mathur, J., Garg, V., & Gupta, R. (2020). Review of studies on thermal comfort in Indian residential buildings. *Science and Technology for the Built Environment*, 26(6), 727-748.
- Santamouris, M., & Osmond, P. (2020). Increasing green infrastructure in cities: Impact on ambient temperature, air quality and heat-related mortality and morbidity. *Buildings*, 10(12), 233.
- Schweiker, M., Huebner, G. M., Kingma, B. R., Kramer, R., & Pallubinsky, H. (2018). Drivers of diversity in human thermal perception—A review for holistic comfort models. *Temperature*, 5(4), 308-342.
- Subedi, S. H. (2021). A Mathematical Study of Effect of Humidity on Human Skin Temperature at Warm Environment. *Journal of the Institute of Engineering*, 16(1), 141-150.
- Tomczyk, A. M., Bednorz, E., & Matzarakis, A. (2020). Human-biometeorological conditions during heat waves in Poland. *International Journal of Climatology*, 40(12), 5043-5055.
- Wang, H., & Liu, L. (2020). Experimental investigation about effect of emotion state on people's thermal comfort. *Energy and Buildings*, 211, 109789.
- Wu, W., Huang, X., & Li, J. (2021). The Risk, Prevention, and Control of Arthropod-Borne Infectious Diseases. In *Prevention and Control of Infectious Diseases in BRI Countries* (pp. 85-100). Springer, Singapore.
- Zhang, C., & Wang, F. (2020). Comfort Management of Fibrous Materials. *Handbook of Fibrous Materials*, 857-887.
- Zhang, S., & Lin, Z. (2020). Predicted Mean Vote with skin temperature from standard effective temperature model. *Building and Environment*, 183, 107133.
- Zhang, Y., Liu, J., Zheng, Z., Fang, Z., Zhang, X., Gao, Y., & Xie, Y. (2020). Analysis of thermal comfort during movement in a semi-open transition space. *Energy and Buildings*, 225, 110312.
- Zhu, L., Wang, B., & Sun, Y. (2020). Multi-objective optimization for energy consumption, daylighting and thermal comfort performance of rural tourism buildings in north China. *Building and Environment*, 176, 106841.



## EFFECT OF CEREAL FLOURS ON THE PROPERTIES OF CONCRETE

Alfa Nasirudeen Musa<sup>1</sup> and Adeleke Babatunde Kazeem<sup>2</sup>

<sup>1</sup>*Bentomat Values Nigeria Limited, Suite 206 Bahama Plaza Gudu District Abuja, Nigeria*

<sup>2</sup>*Darik Homes Limited, Plot 1217 Cadastral Zone B02 Durumi District, Abuja*

In hot weather in order to overcome accelerating effect of high temperature retarding admixture are added to concrete to slow down the initial hydration so that concrete remain plastic and workable for longer period of time which will gives room to high volume placements. The research is aim at investigating the effect of cereal flours made from maize and sorghum on the properties of concrete; this is with a view to establishing the results of the selected cereals as retarder in concrete. The mix used for the research was calculated using the BRE method and the water cement ratio of 0.6 was used. The mix ratio of 1:1.13:3.40 was used. Trial test was conducted with maize, sorghum, wheat and millet. The cereal was ground, sieved and added in various percentages by weight to the cement, mix and cast in a cube of 100 by 100 by 100mm mould left in the mould for 24 hours then demould and immersed in water for seven days. After seven days it was tested for compressive strength, the sorghum and maize gave the highest and higher values of compressive strength respectively and therefore used for the main work. The same procedure was used for the main work the samples used were produced in three different batches. The first sets of batches were the control samples which also served as source of comparison. The second and the third batches had various percentages of maize and sorghum flour added respectively. The curing was done by complete immersion for 1, 3, 7, 28 and 56 days for all the samples. It was observed that the maize flour has higher starch content, PH and solubility than the sorghum flour. The cyanide content of sorghum flour was higher than the maize flour. The compressive strength increase as the age of curing increases. Sorghum flour had higher values of compression strength than maize flour. The optimum compressive strength of the test specimen is achieved at 3% dosage of maize and sorghum flour added to the cement. Maize and Sorghum flour improved the workability of concrete; it was observed that as the dosage of cereal flour increases, the slump increased. Maize and sorghum flour also delay the setting time of cement, for sorghum flour added to cement the setting time is achieved at 410 minutes while for maize is 248 minutes. Sorghum and maize flour are good sources of retarding admixture to concrete.

Keywords: cereal flours, compressive strength, concrete, retarding admixture, setting time

<sup>1</sup> alfanasir04@gmail.com; +2348067822932

<sup>2</sup> bldrbabs309@gmail.com

## INTRODUCTION

Concrete is a construction material made by mixing cement paste (Portland cement and water) and aggregate (sand and stone). The cement-paste is the “glue” which binds the particles in the aggregate together (Malhotra, 2000). (Shetty, 2005) stated that the strength of cement-paste depends on the relative proportion of water and cement, a more dilute paste been weaker. They further stated that concrete hardens through chemical reaction between water and cement without the need for air. The relative proportion of cement-paste and aggregates affects the strength, a high proportion of the paste making stronger concrete.

Due to high temperature when concrete is mixed freshly the water demand for adequate workability is high, other problems associated with this high temperature are increase in concrete shrink loss, difficulties in placing concrete as a result of high rate of setting, increased tendency of plastic shrinkage cracking (Khan and Muhammad, 2004). The hot weather also has tendencies of increasing the temperature of fresh concrete resulting in lower ultimate strength and thermal cracking (Otoko, 2014). As a result of the above mentioned problems associated with fresh concrete due to hot weather retarders are introduced in producing concrete in hot climate so that concrete remain plastic during mixing, transporting, placing, compacting and finishing. These conventional retarding admixtures are rare to find and expensive (Alibaba, 2017) thereby making search for alternative materials to be necessary. The importance of the use of retarder for producing concrete in hot climate cannot be over emphasis as set retarding concrete admixtures delay the chemical reaction that takes place when concrete starts the setting process (Mihai and Rosca, 2008). Retarders as admixture in concrete a lot of initial setting problem could be solved.

According to Okafor (2008), several compounds have been found to exhibit retarding action in concrete and their performance is covered in the British standard BS 5075: Part 1 (1982). Some of these compounds include soluble zinc, salt, borates, sugar and carbohydrate derivatives. Cereal flours are carbohydrate derivatives; they are good source of retarding admixture. Cereal flours are relatively cheap, produced locally in very large quantities and the production of flour from their grains does not require any complicated technology. Using cereal flour will avail more opportunities for the farmers in terms of increase in income from the sale or yield from their farms, this will also create more job opportunities that will increase the standards of living.

Okafor (2008), observed that cassava flour considerably improved the workability of the fresh concrete and delayed the setting time of cement by up to 6 hours. Cassava reduced the early strength of concrete but the long term strength will be improved. According to Otoko (2014), a small quantity of cassava powder (0.05% by weight of cement) has the potential of increasing the workability as well as the long term strength of concrete. Also Abalaka (2011) observed that the compressive strength of sugar as admixture is at peak at 0.05% of sugar concentration. He also ascertained that the maximum strength of cassava powder as admixture is at 0.05% of cassava starch concentration. For the purpose of this research, the researcher intends to investigate the effect of two cereal flours namely maize and sorghum on the properties of concrete.



## LITERATURE REVIEW

### **Retarding admixtures**

Retarding admixtures slow down the initial hydration of cement, lengthening set time. According to the European Federation of Concrete Admixture Associations (2005), retarding admixture make up of 1.5% of admixtures sold in Europe. Retarders are beneficially used in hot weather condition in order to overcome accelerating effects of higher temperature and large masses of concrete on concrete setting time (American Concrete Institute, 1999). It functions by coating the surface of C3S (Tricalcium Silicate) components, thus, delaying the reaction with water. Reaction products are slow to form as such the setting and hardening of concrete are delayed reducing early compressive strength (Rixom et al., 1999). According to the European Federation of Concrete Admixture Associations (2005) Retarders can be used in hot weather to prevent early stiffening and;

- To increase working life, especially when used in conjunction with superplasticisers.
- To allow the placing of a large pour of concrete over several hours.
- To place concrete in layers without cold joints.
- To extend the time between mixing and placing (e.g., for long transport time).
- Prevent setting of the concrete in the truck in case of delay.

According to the National Ready Mixed Concrete Association (2001), for large jobs, or in hot weather, retarding admixture should be added to concrete to allow more time for placing and finishing. Most retarders also function as water reducers. Retarders should meet the requirements for type B or D in ASTM C 494 – 12 (2002). Retarding admixture are used to offset unwanted effect of high temperature such as acceleration of set and reduction of 28 day compressive strength and to keep concrete workable during the entire placing and consolidation period (ACI Education Committee, 2013).

### ***Types of retarding admixture***

According to ASTM C494 – 12 (2002), there are three (3) kinds of retarders namely

- Type C (Retarding Admixtures) this simply retards the hydration of Portland cement
- Type D (water reducing and Retarding Admixtures) this does not only retards the hydration but also acts to disperse the cement particle and thereby provides water reduction. According to Dias, Dewapriya, Edirisooriya and Jayathunga (2010) the most commonly used chemical retarder is the type D. The main differences between type C and D are the water – reducing characteristic in type D that gives higher compressive strengths by lowering water – cement ration (Dias et al., 2010).
- Type G ( High range water reducing and retarding admixture)

### ***Chemical Composition of retarding admixture***

Retarding Admixtures consists of both organic and inorganic agents. The main ingredients of organic retarders are as follows:

- Lignosulphonic acids and their salts. Example sodium (Na), Calcium (Ca) or Ammonium (NH<sub>4</sub>).

- Hydro-carboxylic acids and their salts.
- Carbohydrates including sugar.

The main ingredients of inorganic retarder are oxides of

- Lead and zinc
- Phosphates
- Magnesium
- Fluorates and borates

#### ***Advantages of retarding admixtures***

- In large scale construction, retarding admixtures permits greater flexibility in extending the time of set and prevention of cold joint.
- Retarding Admixtures improves workability, cohesion and extends setting time, provide protection against delays and stoppages and facilitates keeping workable concrete for extended period.
- Facilitates finishing in hot weather, improves pumpability, cohesion and workability of concrete.
- Reduces bleeding and segregation where poor sand grading are unavoidable.
- Reduces adverse environmental effects of various nature on concrete and embedded steel by consideration of reduction in permeability.

#### ***Where retarding admixture are used***

Retarding admixture are used in concrete to offset the accelerating effects of high temperature which decrease setting time to avoid compilation when unavoidable delays between mixing and placing occur ( United State Department of Transportation (FHWA, 2015). Retarding concrete admixtures are used to delay the chemical reaction that take place when the concrete starts the setting process. Retarding admixture are used in concrete pavement construction, allowing more time for finishing concrete pavements reducing additional costs to place a new concrete batch plant on the job site and helps eliminate cold joints in concrete, retarders can also be used to resist cracking due to form deflection that can occur when horizontal slabs are placed in sections. Most retarder also functions as water reducers and may entrain some air in concrete, (Khan et al.,2004).

According to Mihai et al., (2008), retarder serve best to compensate for unwanted accelerations of working times due to changes in temperature of cement or due to other admixture side effects. They also are used to extend the working time required for complicated or high – volume placements and for retarding the set of concrete at a surface where an exposed aggregate finish is desired. Retarding admixtures are used

- Where long transportation of ready mixed concrete is required then premature setting can be usefully avoided by this type of admixture.
- When concrete is being placed or transported under conditions of high ambient temperature.
- In case of large concrete pours.
- Concrete construction involving sliding formwork.

Retarders are used in varying proportions, often in combination with other admixtures, so that, as working temperatures increase, higher doses of the

admixture may be used to obtain a uniform setting time (Mihai et al.,2008). Simple retarders typically consist of one of four relatively inexpensive materials: lignin, borax, sugars, or tartaric acids or salts (Khan et al., 2004). Retarding admixtures are widely appreciated as these can improve both mixing water efficiency and delay initial set of concrete mixes. This improvement in water is used to provide increased strength, density and workability without rise in cement, while retardation of setting times permits ignorance of cold joint where delay in transporting and placing concrete take place. Retarding admixtures are used on towers, chimneys, high building, tunnels/shaft lining and offshore construction.

#### ***Problems associated with the use of retarding admixtures***

The prime function of retarding admixture is to delay the setting of concrete. Over usage of retarding admixture on concrete can result to the following side effect

- Excessive dosage may excessively delay hardening of concrete
- A decrease of early strength within the first 24 hours
- Increase bleedings
- An increase in slump
- A slight increase of the plastic shrinkage
- Creep, drying shrinkage
- Durability are not significantly affected by the inclusion of retarding admixture.

#### ***Possible Cost of Retarder Admixture***

The production cost of concrete we use in construction is very high so we use different methodology to bring down the high price for example different types of admixtures are used to enhance the properties of concrete. Retarders are used to enhance the properties of concrete in hot weather (Kumar, 2015). Producers uses admixture to bring special properties to the fresh or hardened concrete; these special properties are related to the reduction of water consumption, increased resistance to compression or extension of the setting time, and others, they also can improve the durability, workability and strength of a concrete mixture and also is used to overcome difficult situations in construction such as casts in hot or cold weather, pumping requirements, early strength requirements or specifications of a water/cement ratio very low.

Retarding admixture are usually not manufactures in Nigeria, not really available and expensive. According to Alibaba (2017) the available retarding concrete admixtures in Nigeria market are:

- Sodium Gluconate set retarding concrete admixture
- Retarding concrete admixture
- Sodium Naphthalene set retarder concrete admixture
- Lignin Sulfonate water retarder

According to Alibaba (2017) one ton of sodium gluconate retarding concrete admixture cost range from 140,000 naira to 150,500 naira, one metric ton of sodium gluconate retarding concrete admixture cost range from 192,500 naira to 210,000 naira, one ton of retarding concrete admixture cost range from 140,000 naira to 525,000 naira, one ton of sodium Naphthalene set retarder cost range from

150,000 naira to 200,000 naira, and one metric ton of Lignin Sulfonate water retarder calcium cost range from 4,000 naira and above.

### ***Effect of retarders on cement paste***

When water is first added to cement there is a rapid initial hydration reaction, after which there is little formation of further hydrates for typically 2–3 hours (Ballieu, 2013) The exact time depends mainly on the cement type and the temperature (Portland Cement Association, 2015). This is called the dormant period when the concrete is plastic and can be placed (Baradan, 1998). At the end of the dormant period, the hydration rate increases and a lot of calcium silicate hydrate and calcium hydroxide is formed relatively quickly (Portland Cement Association, 2015). This corresponds to the setting time of the concrete. Cement paste/concrete set gradually under the standard laboratory condition (temperature 23°C and relative humidity not less than 90%) ASTM C 191 – 77, (2013). Outside the laboratory concreting is done under harsh or mild weather. In Northern part of Nigeria concreting is usually subjected to hot weather which is defined as any combination of high air temperature low relative humidity wind velocity and intensities of solar radiation (Khan et al., 2004) tending to adversely affect the quality of fresh and hardened concrete.

### **Cereal flour as retarding admixtures**

According to Ioannis and Persefoni (2008) Cereal crops are mostly grasses cultivated for their edible seeds (actually a fruit called Caryopsis). Cereal grains are grown in greater quantities worldwide than any other type of crop and provide more food energy to the human race than any other crops. The seven principal cereals grown in the world are wheat, maize, rice, barley, oats, rye and sorghum (FAOSat, 2014). Their mature dry kernels (seeds) are often called cereal grains. All cereals crops belong to the grass family Gramineae that accounts for the major portion of the monocot (monocotyledonae) division of flowering (seed – producing) plants (Lantican, 2001).

Cereal flours are carbohydrate derivatives; they are good source of retarding admixture. ASTM C494 – 12 (2002), defined retarding admixture as admixture that are used to slow down the speed of the reaction between cement and water by affecting the growth of the hydration products and/or reducing the rate of water penetration to the cement particles.

According to the European Federation of Concrete Admixture Association (2005), Retarding admixture are used for the following purpose

- i. In hot weather to prevent early stiffening;
- ii. To increase working life, that is increase workability;
- iii. To allow the placing of a large pour of concrete over several hours;
- iv. To place concrete in layers without cold joints;
- v. To extend the time between mixing and placing (e.g., for long transport time);
- vi. Prevent setting of the concrete in the truck in case of delay.

Soluble carbohydrate derivative admixtures like sugar, water soluble carbohydrate such as soluble starch (cassava and cereal flours) and dextrans are effective retarding admixtures. Very small dosage of the order of 0.05 to 0.1 percent of mass

of cement is enough. 0.05 percent sugar can delay initial setting time by about four hours (Gambhir, 2004).

## **MATERIALS AND METHOD**

### **Materials**

The materials used in the research include cement, sand, crushed granite, water, sorghum flour and maize flour.

#### ***Cement***

The cement used for this research work was ordinary Portland cement OPC, grade 42 conforming to BS 12:1996 manufactured by Dangote Cement Company obtained from Samaru Zaria.

#### ***Coarse aggregate***

The coarse aggregates used were crushed granite with maximum nominal size of 20mm and was then sieved by using sieves conforming to BS 812 – 103.1:1985

#### ***Fine aggregate***

The fine aggregate used in this research work was sieved conforming to BS 812 - 103.1:1985. The fine aggregate used was sourced from a river in Zaria and having nominal maximum size of 5mm.

#### ***Water***

Clean tap water deemed for drinking was used for the production and curing of concrete samples for this research. The water conforms to BS EN 1008.2:2002.

#### ***Cereal flours***

The cereal was obtained from Seed Production unit of Institute for Agricultural Research (IAR), Ahamdu Bello University, Zaria. The maize used is Sammaz 15 and the sorghum used is Samsara 17. The cereals were grinded in the milling centre of the same Institute. The milling machine was thoroughly washed, allowed to dry and used to ground the cereal seeds to powdered texture. The cereal flour was taken to the laboratory of Department of Building, Ahamdu Bello University Zaria and sieved in accordance with BS sieve number 85 (standard sieves and mesh size) to remove any chaff present in the flour.

#### ***Proximate analysis of sorghum flour***

The samples of the sieved cereal flours were taken to Faculty of Agriculture, Department of Animal Sciences (Biochemical Laboratory Unit), Ahamdu Bello University, Zaria to determine the starch content, PH value, solubility and cyanide content.

### **Preparation of specimen**

#### ***Trail mix***

A trail mix was designed using BRE method from which the quantities of the various constituents of concrete was derived using concrete mix of 1:1.13: 3.40 (1 part of cement, 1.13 parts of fine aggregate and 3.40 parts of coarse aggregate) and water cement ratio of 0.6.

The various constituents of the concrete mix were batched as obtained from the design, the batching was done by weight using an electronic scale, after which the portion of the cereal flour was thoroughly mixed with the cement and added to the aggregates mixed dry until an homogenous mixture was achieved. Water was then added and the mixing continued for few minutes after which the concrete was placed in a 100 x 100 x 100 mm mould in three layers, each layer was compacted 25 times with a tamping rod to exclude all voids in the concrete, the cast concrete was allowed to set for 24 hours after which it was demoulded and put in a curing tank; the curing method used was complete immersion.

This process was repeated for concrete mixes containing four different cereal flours namely maize, sorghum, millet and wheat and percentages of cereal flours added to the cement were 1% to 5% respectively. After 7 days of curing the cast samples were removed from the curing tank and sun dried for 2 hours and then tested for compressive strengths by placing them in crushing machine and the crushing load of each specimen was recorded.

After the tests were carried out and the results compared with the control mix (that is mix without any cereal flour). It was observed that the samples containing maize and sorghum had the higher and highest values of compression respectively; hence they were used to conduct this research.

#### ***Final mix***

The proportioning of the mix was carried out by batching the various quantities of the constituents as derived from the concrete mix design using the BRE method. The mixing was done using mixing machine, but each cast sample was cured for different period of 1, 3, 7, 28 and 56 days. For the control mix (that is no cereal flour added) and the specimen with maize and sorghum in the various percentages of 1% to 5% respectively. The mould were clamped together to prevent leakage of cement paste and it was ensured that every batch of mix was placed in mould to produce cube samples with regular surfaces. The samples were demoulded after 24 hours and then transferred into the curing tank for curing until the desired age for testing ( 1, 3, 7, 28 and 56 days) was attained. The properties of the hardened concrete samples tested were compressive strength.

## **RESULTS AND DISCUSSION**

### **Proximate analysis of cereal flour**

Table 1 presents results of the proximate analysis test of cereal flour used for the research, Maize (Sammaz 15) and sorghum (Samsara 17). It was observed that the maize has higher starch content, PH and solubility than the sorghum. The starch content of the maize was 85.62%, PH was 7.94%, and solubility was 4.78% while the starch content of sorghum was 83.57%, PH was 7.31% and solubility was 4.19%. The cyanide content of sorghum was higher than maize, the cyanide content of sorghum was 2.22% and maize was 0.8%. The maize flour is more alkaline than the sorghum flour this means that the maize flour may have lower compressive strength of the test sample (Sharma and Sood, 2015). From Table 1, the P value shows that there is significant difference between the starch content, PH, solubility, cyanide content of maize flour and sorghum flour.

**Table 1: Proximate analysis of maize and sorghum flour**

Parameters	Maize flour added to concrete	Sorghum flour added to concrete	P Value
	Mean $\pm$ S.E	Mean $\pm$ S.E	
STARCH (%)	85.62 $\pm$ 0.00	83.57 $\pm$ 0.00	0.00
PH(%)	7.94 $\pm$ 0.00	7.31 $\pm$ 0.00	0.00
SOLUBILITY(%)	4.78 $\pm$ 0.00	4.19 $\pm$ 0.00	0.00
CYANIDE(%)	0.80 $\pm$ 0.00	2.22 $\pm$ 0.00	0.00

## Results for tests on fresh concrete specimens

### *Workability test of concrete*

Table 2 presents the Slump test results of the fresh concrete made with maize and sorghum flours as admixture. It was observed as the dosage of the cereal flour increases, the slump increased for both maize and sorghum. The maize flour increased from 49mm to 120mm while the sorghum increased from 38mm to 98mm. The P value shows that there are significant differences between the slump test result of maize flour added to concrete and sorghum flour added to concrete.

**Table 2: Slump test result of maize and sorghum flour added to concrete**

Percentage dosage of cereal flour added to concrete	Maize (mm)	Sorghum (mm)	P Values
	Mean $\pm$ S.E	Mean $\pm$ S.E	
0 %	30.00 $\pm$ 0.32	30.00 $\pm$ 0.32	1.00
1 %	49.00 $\pm$ 0.32	38.00 $\pm$ 0.32	0.00
2 %	55.00 $\pm$ 0.32	51.00 $\pm$ 0.32	0.00
3 %	60.00 $\pm$ 0.32	57.00 $\pm$ 0.32	0.00
4 %	80.00 $\pm$ 0.32	74.00 $\pm$ 0.32	0.00
5 %	120.00 $\pm$ 0.32	98.00 $\pm$ 0.32	0.00

### Setting time test

Table 3 presents the setting time of cement produced with different dosage of cereal flour. The results and P value show a significant delay in both the initial and final setting time of cement added with cereal flour. For the maize flour added to cement both the initial and final setting time increases as the dosage level of maize flour increases. For sorghum flour added to cement the initial setting time increase from 1% to 4% and falls at 5% this might probably be due to the fact that the cyanide content of sorghum is higher than that of maize while the final setting time of sorghum increases as the dosage level of sorghum flour increases.

As the accumulation of cyanide content increase the initial setting time increase. This is attributed to the increased cyanide content of the cement due to the increased quantity of the admixture, the cyanide probably alter the alkalinity of the cement environment. However, this condition appears to cease as cyanide becomes exhausted and the retarding action of the carbohydrate restored hence, the final setting time remains unaffected (Okafor, 2008).

**Table 3: Setting time of cement with cereal flour as admixtures**

Dosage of admixture (%)	Initial setting time maize flour added to cement (mins)	Initial setting time sorghum flour added to cement (mins)	P	Final setting time maize flour added to cement (mins)	Final setting time sorghum flour added to cement (mins)	P
	Mean ± S.E	Mean ± S.E		Mean ± S.E	Mean ± S.E	
0	111.02±0.31	111.02 ± 0.32	1.00	201.2±0.34	201.20 ± 0.34	1.00
1	150.04±0.32	221.10 ± 0.33	0.00	248.0±0.32	242.10 ± 0.33	0.00
2	178.06±0.32	338.00 ± 0.31	0.00	317.3±0.20	379.00 ± 0.31	0.00
3	353.22±0.32	381.00 ±0.32	0.00	353.0±0.16	399.10 ± 0.33	0.00
4	210.04±0.35	410.10 ± 0.33	0.00	402.2±0.34	446.1 ± 0.31	0.00
5	248.00±0.32	212.50 ± 0.44	0.00	437.9±0.19	492.00 ± 0.27	0.00

## Results for tests on hardened concrete

### *Density*

Table 4 shows the average density of concrete test samples at different ages of curing. It was observed that there is no uniform change in the density of the sample as the dosage of cereal flour increases with increase in time of storage in water tank. This may be due to the shape of the mold, mixing and compaction. It was also observed that the density of the test concrete samples with cereal flour is higher than that of the control samples. This might be due to the increase in consistency achieved when cereal flour was introduced to the concrete.

**Table 4: Densities of concrete with cereal flour admixtures**

Cereal flour Dosage (%)	1day (Kg/m <sup>3</sup> )	3days (Kg/m <sup>3</sup> )	7days (Kg/m <sup>3</sup> )	28days (Kg/m <sup>3</sup> )	56days (Kg/m <sup>3</sup> )
0%(control)	2300	2421	2486	2440	2526
1% maize	2335	2485	2493	2534	2547
2% maize	2417	2490	2498	2562	2546
3% maize	2380	2483	2497	2450	2547
4% maize	2368	2448	2312	2537	2549
5% maize	2370	2370	2480	2543	2546
1% sorghum	2360	2510	2479	2480	2540
2% sorghum	2375	2490	2460	2486	2544
3% sorghum	2349	2477	2425	2510	2500
4% sorghum	2342	2486	2450	2523	2511
5% sorghum	2344	2480	2400	2480	2440

## Compressive strength

### *Compressive strength of concrete with cereal flour as admixture*

Table 5 shows the compressive strength of concrete containing cereal flour as admixture, it was observed that the compressive strength increases as the dosage of the cereal flour increases. There was increase in strength from 1% to 3% dosage of the maize flour and drop at 4% and 5%. The trends of strength development in sorghum flour added to concrete is similar to that of maize flour added to concrete



except that the sorghum flour has higher results due to the effect of dispersion of cement particle and formation of denser gel due to delayed setting (Okafor, 2008). Other factor may include improved degree of compaction, increase in consistency and enhanced workability (Neville et al., 2010). It can also be observed that at 28 and 56 days the 4% and 5% dosage level of maize flour admixture added to concrete has a lower compressive strength compared to the control concrete. From 1% to 3% dosage of maize flour admixture added to the concrete the strength increases more than the control concrete.

**Table 5: Compressive Strength of Concrete Containing Cereal Flour**

Percentage (%)	Day	Control(N/mm <sup>2</sup> )	Maize(N/mm <sup>2</sup> )	Sorghum(N/m <sup>2</sup> )	F - factor	P - value
		Mean ± S.E	Mean ± S.E	Mean ± S.E		
1	1	7.92 ± 0.18 <sup>a</sup>	8.30 ± 0.37 <sup>a</sup>	11.80 ± 1.20 <sup>b</sup>	8.51	0.05
	3	11.00 ± 0.55 <sup>a</sup>	13.40 ± 0.29 <sup>a</sup>	17.80 ± 1.24 <sup>b</sup>	18.53	0.00
	7	16.60 ± 0.73	17.00 ± 0.27	19.50 ± 1.56	2.42	0.131
	28	25.30 ± 0.37	25.50 ± 0.39	25.20 ± 1.30	0.035	0.965
	56	30.20 ± 0.58 <sup>b</sup>	25.80 ± 0.37 <sup>a</sup>	25.20 ± 1.30 <sup>a</sup>	20.76	0.00
2	1	7.92 ± 0.18 <sup>a</sup>	10.20 ± 0.26 <sup>b</sup>	12.10 ± 0.33 <sup>c</sup>	63.66	0.00
	3	11.00 ± 0.55 <sup>a</sup>	14.60 ± 0.73 <sup>b</sup>	19.40 ± 0.48 <sup>c</sup>	49.79	0.00
	7	16.60 ± 0.73 <sup>a</sup>	17.20 ± 0.56 <sup>a</sup>	21.52 ± 0.72 <sup>b</sup>	15.65	0.00
	28	25.30 ± 0.37	25.60 ± 0.67	25.20 ± 1.30	0.057	0.94
	56	30.20 ± 0.58	27.90 ± 2.00	30.80 ± 0.34	1.57	0.25
3	1	7.92 ± 0.18 <sup>a</sup>	13.60 ± 0.45 <sup>b</sup>	13.60 ± 0.67 <sup>b</sup>	45.99	0.00
	3	11.00 ± 0.55 <sup>a</sup>	17.20 ± 0.64 <sup>b</sup>	20.50 ± 0.75 <sup>c</sup>	54.10	0.00
	7	16.60 ± 0.73 <sup>a</sup>	19.40 ± 0.81 <sup>a</sup>	23.90 ± 0.71 <sup>b</sup>	23.86	0.00
	28	25.30 ± 0.37	26.10 ± 0.74	28.02 ± 1.17	2.80	0.10
	56	30.20 ± 0.58	30.80 ± 0.59	32.80 ± 1.14	2.78	0.10
4	1	7.92 ± 0.18 <sup>a</sup>	11.80 ± 0.37 <sup>b</sup>	11.10 ± 0.18 <sup>b</sup>	62.15	0.00
	3	11.00 ± 0.55 <sup>a</sup>	14.10 ± 0.60 <sup>ab</sup>	15.60 ± 1.19 <sup>b</sup>	7.88	0.007
	7	16.60 ± 0.73	18.40 ± 0.50	18.32 ± 0.99	1.74	0.216
	28	25.30 ± 0.37 <sup>b</sup>	20.04 ± 0.56 <sup>a</sup>	24.80 ± 1.39 <sup>b</sup>	10.54	0.002
	56	30.20 ± 0.58 <sup>b</sup>	24.90 ± 0.64 <sup>a</sup>	23.42 ± 2.26 <sup>a</sup>	6.51	0.01
5	1	7.92 ± 0.18 <sup>a</sup>	8.80 ± 0.46 <sup>a</sup>	11.60 ± 0.29 <sup>b</sup>	33.43	0.00
	3	11.00 ± 0.55 <sup>a</sup>	11.40 ± 0.66 <sup>a</sup>	14.50 ± 0.50 <sup>b</sup>	11.18	0.002
	7	16.60 ± 0.73	18.00 ± 0.57	18.00 ± 0.44	1.85	0.20
	28	25.30 ± 0.37 <sup>c</sup>	20.40 ± 0.43 <sup>a</sup>	23.42 ± 0.55 <sup>b</sup>	29.13	0.00
	56	30.20 ± 0.58 <sup>b</sup>	23.60 ± 1.12 <sup>a</sup>	28.28 ± 1.91 <sup>ab</sup>	6.57	0.01

Source: Laboratory Research Work (2016)

n = 5; data analyzed using one –way ANOVA followed by turkey multiple comparison post hoc test. Values along the same rows with different superscripts a, b, are significantly different ( $p \leq 0.05$ ).

From Table 5, 1% to 3% dosage of sorghum flour added to concrete the compressive strength increases as the ages of curing increases, at 4% and 5% dosage of sorghum flour added to concrete there is a negative effect on the compressive strength at 28 and 56 days, the test sample is lower in strength compared to the control concrete. This is attributed to the prolonged retarding action of the sorghum flour due to the high dosage level of the sorghum flour (Okafor, 2008). The optimum dosage is 3%, the compressive strength increases as the age of curing increases. From Table 4.13 the F – factor and P – values are significant where the superscripts a and b are different. For instance at 1% dosage of sorghum flour added to concrete as admixture the F – factor and P – value are significant at day 1, 3 and 56.

## CONCLUSION

After carrying out the experiments, observation, analysis and discussion on the effects of cereal flour on the properties of concrete the following conclusion were drawn

1. Proximate analysis showed that maize flour has higher starch content, PH and solubility than sorghum flour. The cyanide content of sorghum flour is higher than maize.
2. Maize flour and sorghum flour delays the setting time of cement, for sorghum the setting time is achieved at 410 minutes while maize is 248 minutes. Maize flour as admixture in concrete did not adversely affect the compressive strength of concrete. At 56 days the maximum compressive strength is 30.8 N/mm<sup>2</sup> while that of sorghum at 56 days is 32.5 N/mm<sup>2</sup>. The control is 30.2 N/mm<sup>2</sup>.
3. 3% dosage of maize and sorghum flour appeared to be the approximate dosage for the concrete mix. The optimum compressive strength of the test specimen is achieved at 3% dosage of maize and sorghum flour.
4. The use of sorghum flour as admixture in concrete gives better result in the compressive strength than maize flour.

## REFERENCES

- Abalaka, A. E. (2011). On Comparative Effects of Cassava Starch and Simple Sugar in Cement Mortar and Concrete. *Abubakar Tafawa Belawa University Journal of Environmental Technology*, 4(1). 11 – 24.
- ACI Education Committee (2013), *Chemical Admixture for Concrete*. American Concrete Institute Education Bulletin, Farmington Hills, U.S.A, 4(03).E4 – 12.
- Alibaba, (2017). *Concrete Admixture Price*. Retrieved from [http:// www.m.alibaba.com](http://www.m.alibaba.com)
- American Concrete Institute, (1999). *Chemical Admixture for Concrete*. ACI 212 3R – 04 Farmington Hills MI 4(02).
- American Society of Testing Materials, C 191 – 77 (2013). *Standard Test Methods for Time of Setting of Hydraulic Cement by Vicat Needle*, 100 barrHarbour Drive j P.O Box C. 700, west Conshohocken, PA.
- American Society of Testing Materials, C 494 – 12 (2002). *Standard specification for Classification of Admixture for Concrete*, 100 barrHarbour Drive j P.O Box C. 700, west Conshohocken, PA.

- Ballieu, P. (2013). Concrete Setting Retarder Mechanism. Retrieved from [http://www.academia.edu/9689617/Concrete\\_setting\\_retarder\\_mechanism](http://www.academia.edu/9689617/Concrete_setting_retarder_mechanism).
- Baradan, B. (1998). Construction Materials II (5th Ed.). Dokul Eylul University, Technical Faculty Publication Section, Izmir Turkey.
- British Standard European Norm, 1008–2: (2010). Mixing Water for Concrete Specification for Sampling, Testing and Assessing the Suitability of Water, including Water Recovered from Processes in the Concrete Industry, as Mixing Water for Concrete. BSI Publication British Standard Institution, London.
- British Standard 12. (1996). Specification for Portland Cement, BSI Publication British Standard Institution, London.
- British Standard 812 – 103.1: (1985). Testing Aggregates. Method for Determination of Particle size Distribution. Sieve Tests, BSI Publication British Standard Institution, London.
- British Standard 5075: Part 1. (1982). Specification of Accelerating Admixture, Retarding Admixture and Water Reducing Admixture, BSI Publication British Standard Institution, London.
- Dias, W. P. S., Dewapriya M. A. N., Edirisooriya E. A. C. K., & Jayathunga C. G. (2010). Effects of Large Retarder Overdose on Concrete Strength Development. Engineer Vol 33 No 3. The Institute of Engineers, Sir Lanka
- European Federation of Concrete Admixture Association (2005), Retarding Admixtures Retrieved from <http://www.efca.info>
- FAOSTAT, (2014). Food and Agricultural Commodities Production: Commodities by Regions. Retrieved from <http://faostat3.fao.org/browse/ranking/commodities>
- Gambhir, M. L. (2004). Concrete Technology, (3rd ed.). New Delhi Tata McGraw Hill.
- Ioannis, S. A., & Persefoni, T. (2008). Waste Management for the Food Industries. Retrieved from [www.sciencedirect.com/topics/Social](http://www.sciencedirect.com/topics/Social)
- Khan, B., & Muhammad, U. (2004). Effect of a Retarding Admixture on the setting time of Cement Pastes in Hot weather. JKU: Engineering Sciences 15 (1). 63 – 79.
- Kumar, D. (2015). Sugarcane Molasses in Concrete as Water Reducing – Retarding Admixture. SSRG International Journal of Civil Engineering (SSRG – IJCE) 2(1) 6 – 10.
- Lantican, R. M. (2001). The Science and Practice of Crop Production. UPLB, College, Los Bancos, Laguna: SEARCA and UPLB. 2(6) 4 – 5.
- Malhotra, V. M. (2000). Role of Supplementary Cementing Materials in Reducing Greenhouse Gas Emissions. Concrete Technology for a Sustainable Development in the 21st Century, O.E. Gjorv and K. Sakai, eds., E&FN Spon, London.
- Mihai, P., & Rosca, B. (2008). Characteristics of Concrete with Admixtures. Technical University, Jassy, Department of Concrete, Materials, Technology and Management.
- National Ready Mixed Concrete Association (2001), Variation in Concrete Performance due to batching, concrete in focus, Naylor LCC Gainesville Florida.
- Neville, A. M., & Brooks, J. J. (2010). Concrete Technology (2nd ed.). Pearson Education Limited.
- Okafor, F. O. (2008). The Potentials of Cassava Flour as a Set-Retarding Admixture in Concrete. Nigerian Journal of Technology. 27(1), 5-12.

- Otoko, G. R. (2014). Minimising Hot Weather Effects on Fresh and Hardened Concrete by Use of Cassava Powder as Admixture. *European International Journal of Science and Technology*.3(2). 1 – 8.
- Portland Cement Association, (2015). How Concrete is Made. Retrieved <http://www.cement.org/cement-concrete-basics/how-concrete-is-made>.
- Rixom, M. R., & Mailvaganam, N. P. (1999). *Chemical Admixtures for Concrete* (3rd Ed.). E and FN Spon Limited.
- Sharma, H., & Sood, H. D. (2015). Effect of Concentration of Alkaline Water on Strength of Concrete. *International Journal of Civil Engineering (IJCE)*, 2(2). 4 – 6.
- Shetty, M. S. (2005). *Concrete Technology Theory and Practice*. S. Chand and Company Limited. 7361, Ram Nagar, New Delhi.
- US Department of Transportation FHWA, (2015).Portland Cement. Retrieved from <http://www.fha.dot.gov/infrastructure/materialsgrp/cement>.



## EFFECT OF PALM KERNEL SHELL AS COARSE AGGREGATE ON THE PROPERTIES OF CONCRETE

A. G. Ibrahim<sup>1</sup>, A. Yahya<sup>2</sup>, M. M. Gambo<sup>3</sup>, S. Gambo<sup>4</sup> and J. Usman<sup>5</sup>

<sup>1,4,5</sup>*Department of Building, Faculty of Environmental Design, Ahmadu Bello University, Zaria-Nigeria*

<sup>2</sup>*Department of Building, Faculty of Environmental Studies, Kaduna state University, Kaduna-Nigeria*

<sup>3</sup>*Policy, Research and Partnerships Unit, Shelter Afrique, Nairobi, Kenya*

The prospective shortage of conventional aggregate and the environmental impact due to its production are some of the driving forces promoting the use of agricultural or industrial wastes as aggregate for concrete production. This study investigated the influence of palm kernel shell (PKS) as partial replacement of coarse aggregates on the properties of concrete. Concrete specimens containing 0-30% PKS to partially replace coarse aggregate (crushed granite stone) were produced and subjected to workability, compressive and tensile strengths, abrasion, absorption and sorptivity tests. The specimen with 0% PKS is the control for comparison. The result showed that PKS improved workability but reduced compressive strength, tensile strength and abrasion resistance of concrete. However, the specimen containing 10% PKS showed comparable performance with the control. Therefore, 10% PKS could be used to partially replace crushed granite stone for concrete production.

Keywords: absorption, aggregates, concrete, durability, palm kernel shell (PKS), sorptivity

### INTRODUCTION

Concrete is defined as an artificial material resulting from a carefully controlled mixture of cement, water, fine and coarse aggregates, which takes the shape of its container or formwork when hardened and form solid mass when cured at a suitable temperature and humidity (Alawode & Idowu, 2011). Fine aggregate is generally natural sand and is graded from particles 5mm in size down to the finest particles but excluding dust. Coarse aggregate is a natural gravel or crushed stone usually larger than 5mm and usually less than 160mm in ordinary structure (Mohd,

---

<sup>1</sup> getsomsc12012@gmail.com

<sup>2</sup> yabdurrahman1987@gmail.com

<sup>3</sup> mgambo@shelterafrique.org

<sup>4</sup> gambo12845@gmail.com

<sup>5</sup> jamilonline05@gmail.com

Johnson & Hilimi, 2008). Coarse aggregate deposits consist of gravel or crushed granite that can be readily used in concrete after minimal processing.

The prospective shortage and the environmental impact associated with the conventional coarse aggregates are among the driving forces motivating the use of wastes as aggregate in concrete. In addition, the utilization of waste as aggregates in concrete helps to minimize the environmental burden related to its discriminate disposal (Osei & Jackson, 2012). Moreover, the use of agricultural wastes such as Palm Kernel Shell (PKS) as replacement for coarse aggregate in concrete production seems to be a feasible solution to the problems in terms of practical and economic advantages.

The palm oil industry produces wastes in terms of palm kernel shells (PKS) and palm oil fibres which are usually dumped thereby impacting the environment negatively without any economic benefits. Palm kernel shells are hard, carbonaceous and organic by-products of the processing of the palm oil fruit. Palm kernel shells consists of small size particles, medium size particles and large size particles in the range 0-5mm, 5-10mm and 10-15mm respectively (Alengaram, Mahmud, Jumaat & Shirazi, 2010). The shells have no commercial value, but create disposal and waste management problems.

Several research efforts have been carried out into the use of palm kernel shell as replacement of coarse aggregate in concrete production. Alengaram, Jumaat and Mahmud (2008) used palm kernel shells to produced structural lightweight concrete of up to 35 N/mm<sup>2</sup> compressive strength. The suitability of sawdust and palm kernel shells as replacement for fine and coarse aggregate in the production of reinforced concrete slabs was investigated (Olutoge 2010). Result showed that 25% sawdust and palm kernel shell substitution reduced the cost of concrete production by 7.45% as well as producing lightweight concrete slabs. Alengaram, Muhit, Mohd and Jumaat (2013) discovered that concrete made from palm kernel shells had low workability, water absorption capacity of more than 10% with higher initial surface absorption than ordinary concrete. It also showed higher ductile behaviour, higher shear strength, had 8 times the normal amount of creep and reached compressive strength values of 48N/mm<sup>2</sup>. Palm kernel shells concrete had thermal conductivity of 0.43 W/mK (lower than 0.76 - 3.68 W/mK) usually observed for normal weight concrete. Oyedepo, Olanitori and Olukanni (2015) investigated palm kernel shell as partial replacement for aggregate in asphaltic concrete. Results revealed that crushed palm kernel shell up to 20% can be used as partial replacement of coarse aggregate in asphaltic concrete heavy traffic roads and up to 60% in medium traffic roads. Thus, palm kernel shell is suitable in the production of asphaltic concrete there by achieving free-littering environment as well as economic benefit. Gupta, Singh, Ahmad and Ambedkar (2017) compared concrete produced with palm kernel shell as partial replacement of coarse aggregate and found that around 10% partial replacement of coarse aggregate with palm kernel shells in concrete gives a significant decrease in the cost of construction and weight of the concrete without much affecting the compressive strength of concrete. Proportioning based on the principles of absolute volume method was used to obtain specific properties of lightweight concrete using PKS (Gibigaye, Godonou, Katte and Degan 2017). Mix proportions of C:S: PKS in weight of 1:1.60:0.96 and 1:1.53:0.99 with cement content of 450 kg/m<sup>3</sup> and WC = 0.45 resulted in obtaining

appropriate values for workability ( $\geq 20$  mm), density ( $1800 \leq d \leq 1900$  kg m<sup>3</sup>) and cylindrical compressive strength ( $\geq 15$  N/mm<sup>2</sup>). Response surface methodology was used to design constituent mix proportions of light-weight concrete containing Nigerian palm kernel shells (Oyejobi, Jameel, Sulong, Raji and Ibrahim 2019).

Moreover, Fanijo, Babafemi, and Arowojolu (2020) investigated the performance of concrete made with PKS (as a replacement for coarse aggregate), and laterite (as a partial replacement for fine aggregates). Results showed that the concrete mixtures with only PKS show better workability compared to the control mixture or mixture containing laterite with mechanical properties decreasing as percentage content of PKS and laterite increased in the mix. It was concluded that concrete mixtures with PKS and laterite at 20% or less could be considered in concrete production. Analysis of variance of the results showed that an optimum compressive strength could be reliably predicted. The properties of lightweight concrete made with different sizes (6, 8, 10, & 12 mm) of PKS and mix (each consisting of 25% PKS) was investigated by Danso and Appiah-Agyei (2021). Results showed that a specimen produced with 12mm PKS has better compressive and tensile strengths than other samples in addition to having good bond with other constituent materials.

Although, several works have been done on the use of palm kernel shell as replacement for coarse aggregate in concrete production, however, there is need to determine the physical property, mechanical properties and the durability characteristics of such concrete at a go. The PKS could be used for construction purposes in areas where they are easily available and accessible and places where natural occurring aggregates are not readily available or expensive with the view to promoting them as construction material.

## **MATERIALS AND METHODS**

### **Materials**

The materials used in the experiment are as follows

#### ***Cement***

The cement used in this research was blended cement of Dangote brand (43.5) that satisfied the requirement of BS EN 197-1:2011. The oxides composition and the physical properties of the cement are presented in Table 1.

#### ***Aggregates***

Naturally occurring river sand with maximum particles size 4.75mm and retained on 150 $\mu$ m was used. Prior to its use, the sand was sieved to reduced impurities, silt content and large particles in accordance with BS EN 12620:2013 and used in the experiment. The coarse aggregates used were crushed granite of 20mm maximum size and retained on 5mm which were obtained from quarry site located at the outskirts of Zaria, Kaduna state. The bulk density of the aggregates as presented in Table 2 shows that the fine aggregate has a bulk density of 1800kg/m<sup>3</sup>, crushed granite 1680kg/m<sup>3</sup> and palm kernel shell (PKS) 730kg/m<sup>3</sup>. According to ASTM C330 (1999), the bulk density for sand and crushed granite which are normal weight aggregates is 1450 kg/m<sup>3</sup> to 1800 kg/m<sup>3</sup> respectively. The bulk densities obtained are within the stated range. For the PKS, bulk density of 730kg/m<sup>3</sup> is within the

range recommended by ASTM C330 (1999) for light weight aggregates as cited in Neville (2000). Other physical properties are also shown in Table 2.

**Table 1: Oxides composition and physical properties of cement**

Oxides composition (%)	SiO <sub>2</sub>	Al <sub>2</sub> O <sub>3</sub>	CaO	Fe <sub>2</sub> O <sub>3</sub>	MnO	TiO <sub>2</sub>	ZnO	Total
Dangote cement	9.135	1.357	51.115	2.341	0.04	0.027	0.003	64.018
Physical properties	Soundness	Setting time (m)		Bulk density (Kg/m <sup>3</sup> )	Specific gravity			
		Initial	Final					
	2	90	185	1.53	3.11			

**Table 2: Sieve analysis and physical properties of aggregates**

	Sieve size (mm)	% passing		
		Fine sand	Crush granite	Palm kernel shell
<b>Sieve analysis</b>	19.0	100.00	98.80	99.6
	9.5	100.00	50.20	49.2
	4.75	99.10	1.40	0.90
	2.36	90.00		
	1.00	69.60		
	600 µm	56.20		
	300 µm	7.00		
	150 µm	2.30		
	Pan	0.00		
<b>Physical properties</b>				
Bulk density		1.80	1.68	0.73
Specific gravity		2.61	2.63	1.33
Water absorption (%)		1.77	1.00	21.18
Moisture content (%)		1.50	0.30	9.96
Aggregate impact value (%)			8.72	3.25
Aggregate crushing value (%)			22.29	5.25

## Methods

### *Concrete mix and samples preparation*

An absolute volume method of concrete mixes was used in developing the concrete in the ratio of 1:1.90:2.30. Trial test was carried out with water-cement ratios of 0.45, 0.50 and 0.5., in order to obtain the appropriate water-cement ratio that gives desired slump. Based on the outcomes of the trial test, a water-cement ratio of 0.50 was adopted for the actual experiment. The mixing was done mechanically using concrete mixer. The first mix was made up of the conventional materials (cement, sand & coarse aggregate) which served as control. The second mix was produced by partially replacing crushed granite with PKS at 10%, 20%, and 30 % respectively. After mixing, the specimens were then cast into cubes size



100mm × 100mm × 100mm, and cylinders 200mm x 100mm diameter. A total of eighty-four (84) concrete cubes and forty-eight (48) concrete cylinders were produced. The specimens produced were left in the mould for 24hours in the laboratory, after which they were removed and completely immersed in water until 3, 7, 14 and 28 days of curing.

***Tests on fresh and hardened properties of concrete samples***

*Fresh properties tests*

Slump test was conducted on fresh concrete samples for all percentage replacements of crushed granite with PKS as well as the control to ascertain the workability of the concrete. Procedures from BS 1881: Part 102: (1983) was adopted in carrying out the slump test.

*Hardened properties tests*

The compressive strength test of the specimen was conducted using cubes samples in accordance to BS 1881: part 116, (1983). The specimens were surface dried after removal from water and weighed before crushing to determine the strength properties. Each sample was placed between the plates of compression testing machine and loads were exerted until the point of failure. Three replicates 'cubes were made for specimens at each curing age of 3, 7, 14 and 28 days for each percentage replacements of palm kernel shells including the control. This amounted to a total of 48 specimen cubes for the compressive strength test. The average values of the maximum loads, at which each group of the three specimens failed, were used to determine the compressive strength and the formula for the computation of compressive strength is given below:

$$\text{Compressive Strength (N/mm}^2\text{)} = \frac{\text{Failure Loads (N)}}{\text{Cross sectional Area (mm}^2\text{)}}$$

*Split tensile strength*

The split tensile strength test was carried out using cylinder specimens of 100 x 200 mm size in accordance with ASTM C496. The specimens were surface dried after removal from water and weighed before crushing to determine the tensile strength properties. Each cylinder sample was placed horizontally between the loading surface of compression testing machine and the compression loads was applied until the failure of the cylinder along the vertical diameter. Three replicates cylinders were made for specimens at each curing age of 3, 7, 14 and 28 days for each percentage replacements of palm kernel shells including the control. This amounted to a total of 48 specimen cylinders for the split tensile strength test. The average values of the maximum loads, at which each group of the three specimens failed, were used to determine the split tensile strength and the formula for the computation of tensile strength is given below:

$$\text{Split tensile Strength (N/mm}^2\text{)} = \frac{2P \text{ (N)}}{\pi d \text{ (mm}^2\text{)}}$$

Where, P = Maximum Load Applied (N)

l = Length of Cylinder (mm)

d = Diameter of cylinder (mm)

### **Durability tests**

#### ***Abrasion resistance test***

Because of lack of instrument for carrying out the abrasion test, method improvised by Ibrahim (2014) was adopted where the cubes after being cured for 28 days were dried and weighed. Then 3.5kg load was tied on a metal brush and the brush was used to brush the surface of the specimen cubes to and fro for about 60 counts per minute. The samples were then re-weighed to find the new weight and the percentage loss in weight was then calculated.

#### ***Absorption test***

The test procedure according to BS 1881-122 :( 1983) was adopted which involves drying a specimen to a constant weight in an oven at 105°C for 72 hours. The sample was allowed to cool in the oven, weighed and the mass recorded (W1). Each sample was then immersed in water for 30 minutes. After that, the specimens were removed from the water and dried with a cloth as rapidly as possible until all free water was removed from the surface and re-weighed again (W2). The increase in weight as a percentage of the original weight is expressed as its absorption as shown below.

$$\text{Water Absorption (\%)} = \frac{W2 - W1}{W1} \times 100$$

Where, W1 = Oven dry weight of cubes in grams.

W2 = Wet weight of cubes in grams.

#### ***Sorptivity test***

Sorptivity test was performed in accordance with ASTM C1585-04. The purpose is to determine the rate of absorption of water by unsaturated concrete (capillary rate of absorption of water). Sorptivity is a function of the increased mass of a specimen resulting from absorption of water, relative to the time that one surface is exposed to water. The specimens of the concrete were removed from the curing tank and allowed to dry. They were then put inside an oven and dried at temperature of 50±2°C for 72 hours. At the end, Abro 2000 RTV silicone sealant was applied on the sides of the specimens in order to prevent water ingress through the sides of the specimens. The specimens were then weighted and the masses recorded. Specimens were subjected to Sorptivity test at 1, 5, 10, 20, 30, 60 minutes, 1, 2, 3, 4, 5 and 6 hours and the change in masses were recorded after each testing period.

## RESULTS AND DISCUSSIONS

### Workability

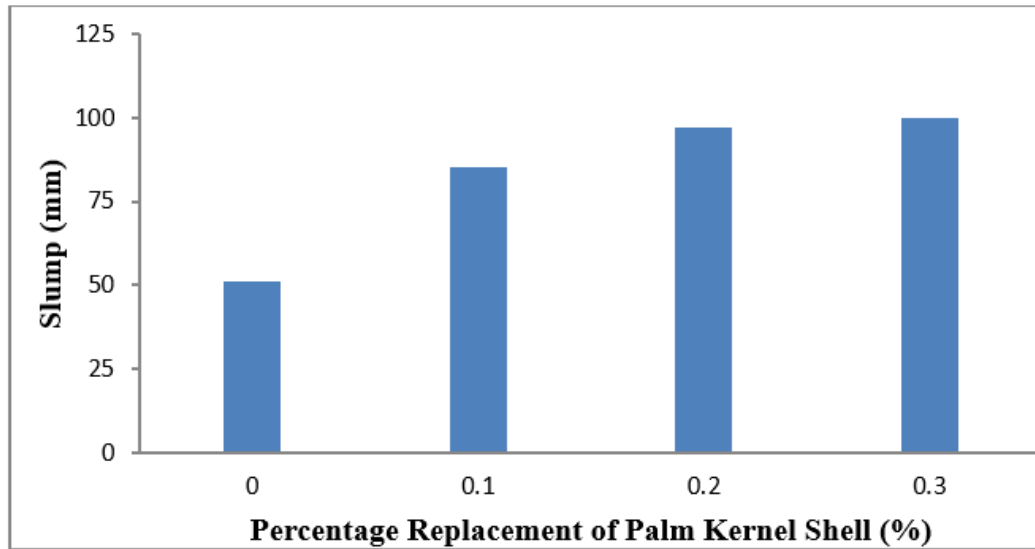

Figure 1: Workability of concrete

Figure 1 shows the slump test result of the concrete at 0%, 10%, 20% and 30% PKS replacement of coarse aggregate concrete specimens. The 0%, 10%, 20% and 30% PKS have slump values of 51mm, 85mm, 97mm and 100mm respectively. An increase of slump value can be observed with increasing partial replacement of crushed granite with PKS in the concrete. The increase in value of slump can be attributed to reduction in crushed granite aggregates that absorbed more water than the PKS. Specimens with PKS absorb less water compare to specimens with crushed granite (Alengaram, Jumaat, Mahmud & Fayyadh 2011).

### Compressive strength

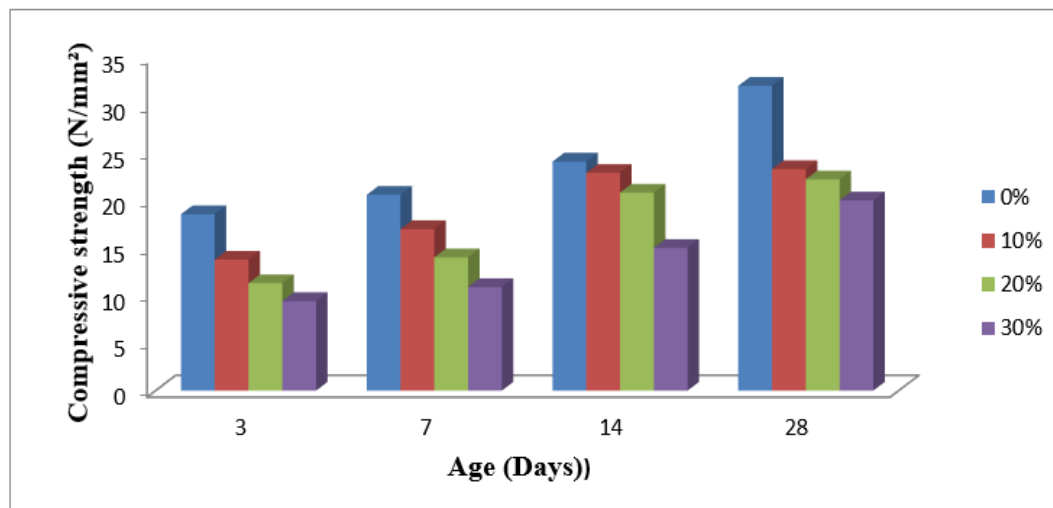

Figure 2: Compressive strength of the concrete specimens

Figure 2 shows the compressive strength of concrete made with palm kernel shell as partial replacement of coarse aggregate at 0%, 10%, 20% and 30% PKS

replacement levels cured at 3, 7, 14 and 28 days. It can be observed that at 3 days, the strengths of 0%, 10%, 20% and 30% PKS specimens are 18.52N/mm<sup>2</sup>, 13.75N/mm<sup>2</sup>, 11.28N/mm<sup>2</sup> and 9.40N/mm<sup>2</sup> respectively. At 28 days of curing; the strengths are 32.02N/mm<sup>2</sup>, 23.26N/mm<sup>2</sup>, 22.19N/mm<sup>2</sup> and 19.98N/mm<sup>2</sup> respectively. It can be noticed that the compressive strength of all specimens increases with ages and 0% (control) specimen recorded the highest strength compared to other specimens. At early age (3 days curing), the control (0%) is higher than 10%, 20% and 30% PKS replacement of coarse aggregates specimens by 26%, 39% and 49% respectively. At 28 days, the control is higher by 27%, 31% and 38% respectively. The 0% specimen is higher than the target strength (30N/mm<sup>2</sup>) by 6.7% while 10%, 20% and 30% PKS replacement specimens are 23%, 26% and 33% less than the target strength respectively. It can be observed that the compressive strength of concrete is directly proportional to the unit weight of the corresponding aggregates, the lower the unit weights of the aggregates, the lower the compressive strength of the concrete. The control specimen has higher compressive strength than specimens containing PKS. The decrease in compressive strength could be attributed to the poor bonding between the cement and PKS. Increase in the % of PKS in the mix creates more voids within the concrete matrix leading to decrease in strength. This finding is consistent with the previous works (Khankhaje et al. 2017; Fanijo, Babafemi and Arowojolu 2020). Moreover, the result also shows that the amount and type of coarse aggregate used in the production of concrete has tremendous influence on the compressive strength of the concrete (Alengaram, Almuhit & Jumaat, 2013). The outcome further revealed that PKS could only be suited to grades 20–35N/mm<sup>2</sup> (Shafigh, Jumaat and Mahmud 2011).

### Split tensile strength

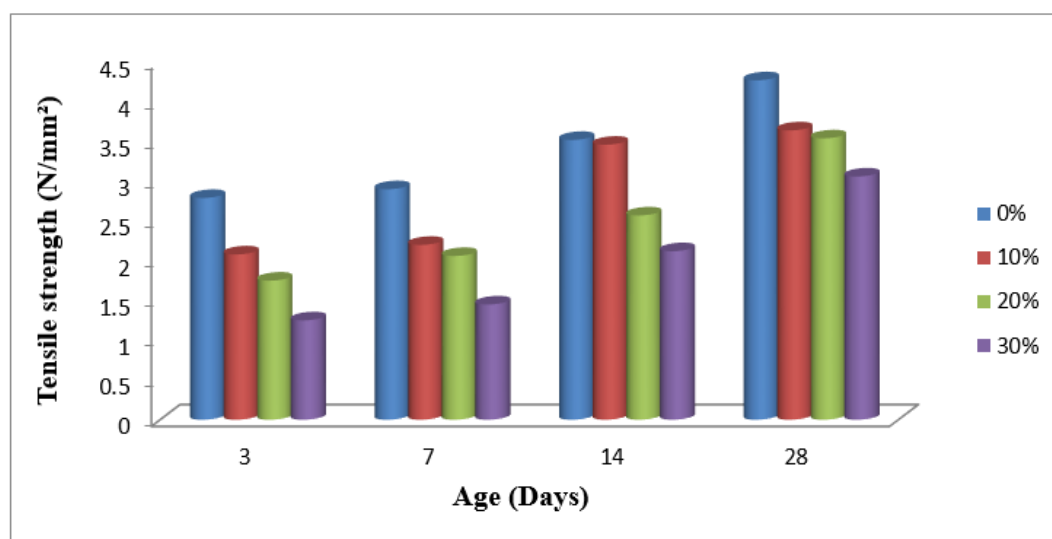

Figure 3: Split tensile strength of the concrete specimens

Figure 3 shows the split tensile strength of concretes made with PKS as partial replacement of coarse aggregates at 3, 7, 14 and 28 days of curing. It can be observed that at 3 days of curing, the 0%, 10%, 20% and 30% PKS replacement levels of coarse aggregates achieved tensile strength of 2.79N/mm<sup>2</sup>, 2.08N/mm<sup>2</sup>, 1.75N/mm<sup>2</sup> and 1.25N/mm<sup>2</sup> respectively. At 28 days, the tensile strength of 0%, 10%, 20% and 30% PKS replacement of coarse aggregates are 4.27N/mm<sup>2</sup>,

3.62N/mm<sup>2</sup>, 3.54N/mm<sup>2</sup> and 3.06N/mm<sup>2</sup> respectively. Generally, outcome of the research showed that the split tensile strength decreases with increase in the percentage replacement of crushed granite with PKS. Similar trend was observed in the compressive strength result. This confirmed the findings of Fanijo, Babafemi and Arowojolu (2020). But from the consideration of the ratio of tensile strength to compressive strength, it can be seen that split tensile strength has very lower values than compressive strength. At 28days, compressive strength was 75% higher than the split tensile strength at 0%, 64% higher at 10%, 63% higher at 20% and 65% higher at 30%. In practice, concrete is not usually expected to resist direct tension because of its low tensile strength. However, the determination of tensile strength of concrete is necessary in order to determine the load at which concrete members may crack.

## DURABILITY PROPERTIES

### Abrasion resistance

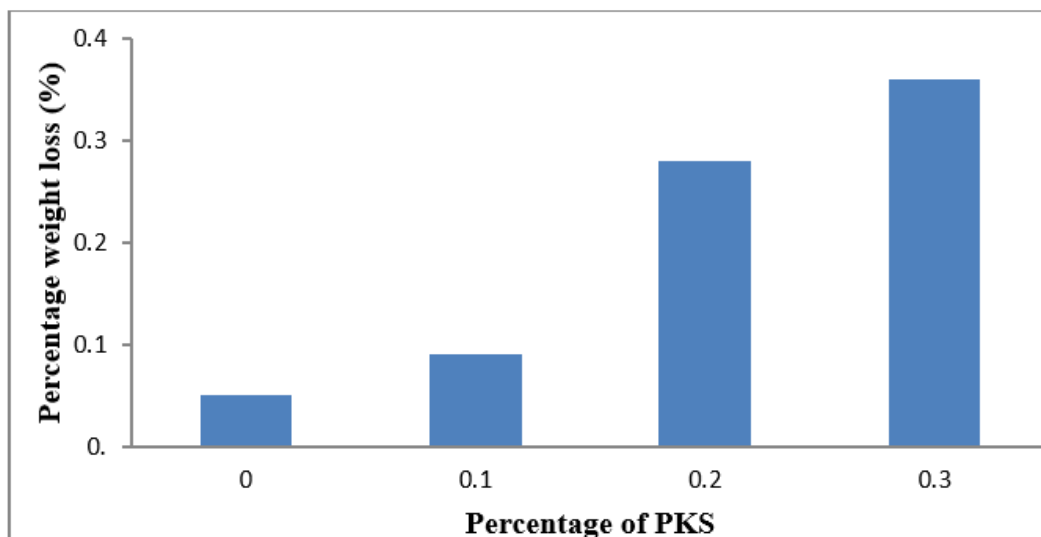

Figure 4: Abrasion resistance of concrete specimens

Figure 4 shows the abrasion resistance of concrete produced with palm kernel shell as partial replacement of coarse aggregate at 28days of curing. The 0%, 10%, 20% and 30% PKS replacement of coarse aggregates abrasion resistance were 0.05%, 0.09%, 0.28% and 0.36% respectively. It can be seen that the level of wearing (in %) increases with increase in the content of palm kernel shell in the concrete. Thus, 0% has the lower wearing value of 18% lower than 10% replacement, 56% lower than 20% replacement and 72% lower than 30% replacement of coarse aggregates. The increase in wearing of palm kernel shell concrete may be due to the lack of proper bonding because of the shapes of palm kernel shell aggregates. It is believed that the compaction strength of concrete is greatly affected by the shape and texture of the aggregates. However, the wearing of palm kernel shell concrete is lower which implies that the concrete possesses good resistance to wear.

### Water Absorption

Figure 5 shows the water absorption of concrete produced with palm kernel shell as partial replacement of coarse aggregate at 28days of curing.

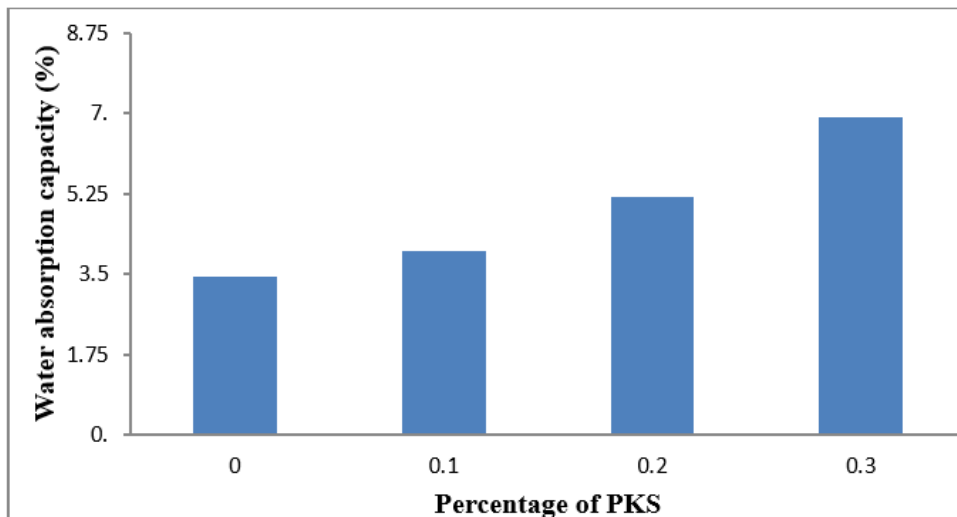

Figure 5: Water absorption of concrete specimens

The water capacity absorption values of 0%, 10%, 20% and 30% PKS replacement of coarse aggregates are 3.45%, 4.01%, 5.18% and 6.92% respectively. It can be seen that the water absorption increases with increase in the percentage content of PKS in the concrete (Fanijo, Babafemi and Arowojolu 2020). The 0% (control) replacement has water absorption of 11% lower than 10% replacement, 15% lower than 20% replacement and 20% lower than 30% replacement. The high water-absorption of palm kernel shell concrete can be attributed to the porosity of palm kernel shell aggregates. Results showed that only 0% (control) and 10% specimens with water absorption values of 3.45% and 4.01% satisfied the requirement of ASTM C1585 (2004) standards which specified that the average water absorption of test sample shall not be greater than 5%. However, the average water absorption capacity of 20% and 30% replacement of PKS were 5.18% and 6.92% respectively.

### Sorptivity

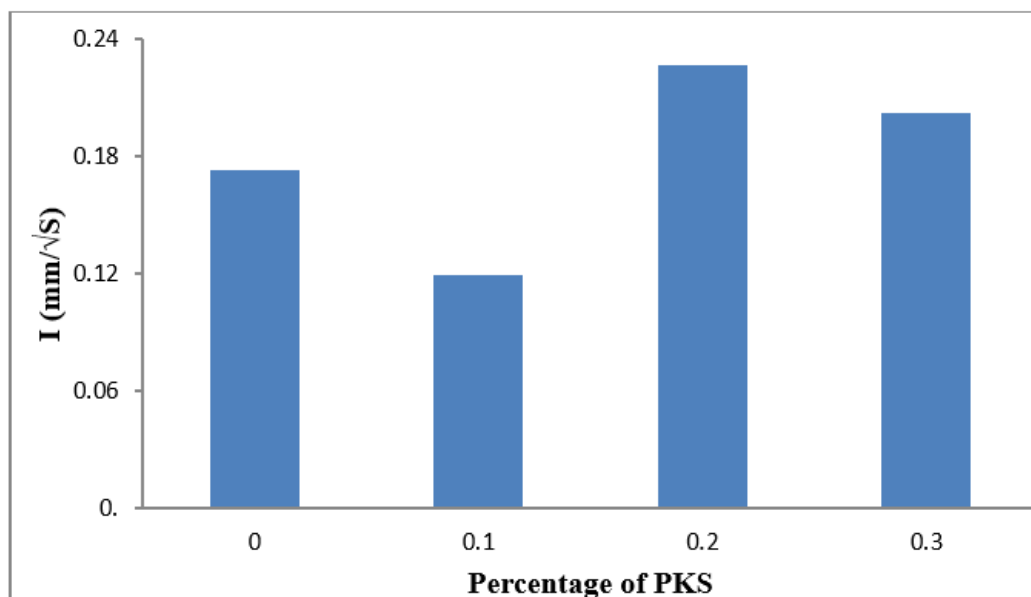

Figure 6: Sorptivity of concrete specimens

Figure 6 shows that the rate of water absorption of concrete produced with 0%, 10%, 20% and 30% PKS replacement of coarse aggregates at 28 days of curing. Results show that the rate of water absorption of concrete specimens is 0.173 mm/√S, 0.1191 mm/√S, 0.2262 mm/√S and 0.2024 mm/√S for 0%, 10%, 20% and 30% PKS replacement of coarse aggregates respectively. It can be observed that the rate of water absorption value of 10% was 45% lower than 0% (control), 53% lower than 20% and 59% lower than 30%. Despite the fact that PKS aggregates absorb more water than the granites, the concrete specimens with PKS have lower rate of water absorption, which implies that PKS concrete may not absorb more water through capillary.

## CONCLUSIONS

Based on the results, analysis and the discussion made, the following conclusions were drawn:

- i. Palm kernel shells (PKS) possess good crushing and impact values of 5.25% and 3.25%.
- ii. The 28 days compressive strength of PKS concrete falls within the standard specification for lightweight concrete, thereby making PKS suitable as aggregates for the construction of lightweight structures. Results showed that PKS increased the void content of the concrete, and in turn also decreased the mechanical properties as the amount of PKS added increased. This was due to angular shape of the PKS particles that disturbed the granular arrangement of concrete.
- iii. The use of palm kernel shells as replacement for coarse aggregate in concrete production can give better result at 10% replacement.
- iv. Concretes made with palm kernel shells possess good resistance to wearing, thereby encourage its uses in an environment where it will be exposed to wear and tear.
- v. The lower rate of absorption of palm kernel shell concrete suggested that palm kernel shell concrete may not absorb more water through capillary when exposed to an aggressive environment.
- vi. The use of PKS in concrete would provide a cheap source of coarse aggregate material thereby reducing the demand for naturally occurring coarse aggregates.
- vii. It was recommended that further study be carried out to assess the durability of concrete made with PKS exposed to chemically aggressive environment.

## REFERENCES

- Acheampong, A. (2015). Shear Strength Properties of Structural Lightweight Reinforced Concrete Beams and Two-way Slabs Using Palm Kernel Shell Coarse Aggregates. Project Report.

- Acheampong, A., Adom-Asamoah, M., Ayarkwa, J., & Afrifa, R. (2015), Code compliant behaviour of palm kernel shell reinforced concrete (RC) beams in shear, *Journal of Civil Engineering and Construction Technology*,6(4), 59-70.
- Alengaram, U. J., Jumaat, M. Z., Mahmud, H., & Fayyadh, M. M. (2011). Shear behaviour of reinforced palm kernel shell concrete beams, *Construction and Building Materials* 25, 2918–2927
- Alawode, O., & Idowu, O. I. (2011). Effects of Water-Cement Ratios on the Compressive Strength and Workability of Concrete and Lateritic Concrete Mixes. *The Pacific Journal of Science and Technology*.12(2) 99 – 105.
- Alengaram, U. J., Muhit, B. A. A., Mohd, Z., & Jumaat, M. (2013). Utilization of Oil Palm Kernel Shell as Lightweight Aggregate in Concrete – A Review. *Construction and Building Materials*, 38, 161–172.
- Alengaram, U. J., Jumaat, M. Z., Mahmud, H., & Fayyadh, M. M. (2011). Shear Behavior of Reinforced Palm Kernel Shell Concrete Beams. *Construction and Building Materials*, 26(6), 2918–2927.
- Alengaram, U. J., Mahmud, H., Jumaat, M. Z., & Shirazi, S. M. (2010). Effect of Aggregate Size and Proportion on Strength Properties of Palm Kernel Shell Concrete. *International Journal of the Physical Sciences*, 5 (12), 1848-1856.
- American Standard Test Methods, ASTM C 373 (2014) Standard Test Methods for Water Absorption, Bulk density, Apparent Porosity and Apparent Specific gravity.
- American Standard Test Methods, ASTM C 779-05 (2008) Test for Abrasion Resistance of Horizontal Concrete Surface.
- American Society for Testing and Materials (2007) ASTM C 127-07: Standard Test Method for Specific Gravity and Absorption of Coarse Aggregate. Philadelphia, PA.
- American Society for Testing and Materials (2007) ASTM C 1585-04: Standard test method for Measurement of Rate of Absorption of Water by Hydraulic-Cement Concretes.
- American Society for Testing and Materials (2004) ASTM C 1585: Standard test method for Measurement of Rate of Absorption of Water by Hydraulic-Cement Concretes.
- American Society for Testing and Materials (1999) ASTM C330: Standard Specification for Lightweight Aggregates for Structural Concrete. Annual Book of ASTM Standards.
- British Standards Institution (1995) BS 812 Part 2. Methods of Determination of Density. BSI Publications, London.
- British Standards Institution European Norm (1995) BS EN 196 – Methods of Testing cement. Part 3: Determination of Setting Time and Soundness. BSI, London
- British Standard Institution: BS EN 12620:2013 Aggregates for concrete, BSI Publications, London.
- British Standards Institution (1985) BS 812 – Testing Aggregates Part 103 – Methods for Determination of Particle Size Distribution – Section 103.1 – Sieve Tests. BSI, London.
- British Standards Institution (1983) BS 1881: Part 102: Method for Determination of Slump. Her Majesty Stationery Office, London.
- British Standards Institution (1983) BS 1881: Part 116: Methods for Determination of Compressive strength of Concrete Cubes. BSI Publications, London.



- Danso, H., & Appiah-Agyei, F. (2021) Size Variation of Palm Kernel Shells as Replacement of Coarse Aggregate for Lightweight Concrete Production. *Open Journal of Civil Engineering*, 11, 153-165. <https://doi.org/10.4236/ojce.2021.1111010>
- Fanijo, E., Babafemi, A. J., & Arowojolu, O. (2020). Performance of laterized concrete made with palm kernel shell as replacement for coarse aggregate, *Construction and Building Materials*, Elsevier, 250 (118829), 1-10, <https://doi.org/10.1016/j.conbuildmat.2020.118829>
- Gibigaye, M., Godonou, G. F., Katte R., & Degan, G. (2017). Structured mixture proportioning for oil palm kernel shell concrete, *Case Studies in Construction Materials*, Elsevier, 6, 219–224, <http://dx.doi.org/10.1016/j.cscm.2017.04.004>,
- Gupta, S. K., Singh, S., Ahmad, S., & Ambedkar, V. L. (2017). Partial Replacement of Coarse Aggregate with Palm Kernel Shell in Concrete. *International Journal of Engineering Research & Technology*, 6(04), 65 – 68.
- Harimi, M., Hrimi, D., Kurian, V. J., & Nurmin, B. (2007), Evaluation of the Thermal Performance of Metal Roofing Under Tropical Climatic Performance of Metal Roofing Under Topical Climatic Conditions, *Malaysian Construction Research Journal (MCRJ)*, 1(1), 72-80.
- Jumaat, M. Z., Alengaram, U. J., & Mahmud, H. (2009), Shear Strength of Oil Palm Shell Foamed Concrete Beams, *Materials and Design*, 30(6), 2227–2236.
- Khankhaje E., et al. (2017). Properties of quiet pervious concrete containing oil palm kernel Shell and cockleshell, *Applied Acoustics*, Elsevier, 122, 113–120
- Mohd, Z. J., Johnson, U. A., & Hilimi, M. (2008). Ductility Behaviour of Reinforced Palm Kernel Shell Concrete Beams, *European Journal of Scientific*, 23(3), 406-420.
- Ndoke, P. N. (2006) Performance of Palm Kernel Shells as a Partial Replacement for Coarse Aggregate in Asphalt Concrete. *Leonardo Electronic Journal of Practices and Technologies*, 5(9), 145–152.
- Neville A. M., & Brooks J. J. (2010). *Concrete Technology*, 2nd Edition, ISBN 978-0-273-73219-8
- Olanipekun, E. A., Olusola, K. O., & Ata, O. (2006), A Comparative Study of Concrete Properties Using Coconut Shell and Palm Kernel Shell as Coarse Aggregates. *Building and Environment*, 41(3), 297–301.
- Olutoge, F. A. (2010), Investigations on Sawdust and Palm Kernel Shells as Aggregate Replacement, *Asian Research Publishing Network (ARPN) Journal of Engineering and Applied Sciences*, 5(4), 7-13.
- Osei, D. Y. & Jackson, E. N. (2012). Experimental Study on Palm Kernel Shells as Coarse Aggregate in Concrete. *International Journal of Scientific & Engineering Research*. 3(8), 1-6.
- Oyedepo, O. J., Olanitori, L. M., & Olukanni, E. O. (2015). Investigation of Palm Kernel Shell as Partial Replacement for Aggregate in Asphaltic Concrete. *Malaysian Journal of Civil Engineering*. 27(2), 223-234.
- Oyejobi, D. O., Jameel, M., Sulong, N. H. R., Raji, S. A., & Ibrahim, H. A. (2019). Prediction of optimum compressive strength of light-weight concrete containing Nigerian palm kernel shells. *Journal of King Saud University– Engineering Sciences*, xxx (xxxx) xxx, <https://doi.org/10.1016/j.jksues.2019.04.001>
- Shafigh, P., Jumaat, M. Z., Mahmud, H. B., & Hamid, N. A. A. (2012). Light Weight Concrete Made From Crush Oil Palm Shell: Tensile Strength and Effect of Initial Curing on Compressive Strength.

- Shafiqh, P., Jumaat, M. Z., Mahmud, H. B., & Alengaram, U. J. (2011). A New Method of Producing HighStrength Oil Palm Shell Light Weight Concrete.
- Shafiqh, P., Jumaat, Z. M., & Mahmud, H. (2010), Mix Design and Mechanical Properties of Oil Palm Shell Lightweight Aggregate Concrete: A review, *International Journal of the Physical Sciences*, 5(14), 2127-2134.
- Shetty, M. S. (2015), *Concrete technology Theory and Practice*, India, S. Chand & Company Ltd., India.
- Zayed, A. M., Brown, K., & Hanhan, A. (2004), *Effect of Sulfur Trioxide Content on Concrete Structures Using Florida Materials*, Florida Department of Transportation, Florida, USA.



## EFFECT OF PETROLEUM CONTAMINATION ON PROPERTIES OF COMPRESSED STABILIZED EARTH BRICK (CSEB)

K. A. N. Sackey<sup>1</sup>, M. M. Garba<sup>2</sup>, O. G. Okoli<sup>3</sup> and D. D. Dahiru<sup>4</sup>

<sup>1,2,3,4</sup>*Department of Building, Ahmadu Bello University, Zaria, Kaduna State, Nigeria*

The Niger Delta region is the epicenter of petroleum exploration and extraction activities in Nigeria contributing to oil spills experienced in the region. Attention has been drawn to its effects on fishing and farming activities while less attention is paid to effects on soils for construction activities. This research ascertained the effect the presence of petroleum had on properties of compressed stabilized earth bricks (CSEBs) made from artificial petroleum contaminated laterite. Three sets of bricks were produced having a binder made up of rice husk ash (RHA), carbide and cement in predetermined proportions. Out of the three sets, two sets were made from laterite artificially contaminated with 2% and 3% petroleum while the third set had no contamination and acted as the control (0%). The results revealed that bricks made from petroleum contaminated laterite performed favourably on all selected tests in relation to the control at the various allotted test days respectively. It can therefore be inferred that laterite having petroleum contaminants in very minute quantities in combination with pozzolans like rice husk ash (RHA) and carbide can be used for the production of CSEBs and utilized in building construction in the Niger Delta region of Nigeria.

Keywords: compressed stabilised earth brick, laterite, petroleum, pozzolans

### INTRODUCTION

In order to have an eventful existence, every living being requires a home for sanctuary and convenience in the execution of everyday activities as well as for prestige. Aminu & Ruhizal (2013) defined a home as a place for refuge, security, comfort and dignity. It is one of the three basic requirements for any individual apart from food and clothing. In the absence of shelter, his daily activities will be adversely affected (Sackey, Garba, Mamman & Adeleke 2018).

As of today, houses are constructed with numerous building materials of which concrete and steel occupy the top spots for materials used in building construction. Generally, some of these building materials are quite expensive as well as increasingly becoming scarce. Water bodies are steadily drying up from the twin effects of high temperatures caused by global warming and the increase in water

<sup>1</sup> kwekusackey@yahoo.com

<sup>2</sup> mmagajigarbaa@yahoo.com

<sup>3</sup> okolygody02@yahoo.com

<sup>4</sup> daudadahiru509@gmail.com

demands brought about by population explosion. These twin effects adversely affected the availability of sharp sand which is an important constituent of concrete. Also, the excessive demand for cement has led to the destruction of the natural features of the ground topography in areas where limestone is extracted for cement production. In addition, the gaseous discharges such as smoke and dust released from cement producing factories affects air quality and disrupts the photosynthesis processes for plants (Sackey, Garba, Mamman & Adeleke 2019). As a result of these uncontrolled extractive activities, farmlands as well as plant and animal habitats are steadily destroyed in addition to the creation of erosion and gully formations which are some of the features of man-made disasters.

Again, the blasting of rocks at quarry sites in search of coarse aggregates has its resultant effects in the form of noise pollution, injuries, destruction of properties located near such quarries in addition to the depletion of scenic sites where these rock formations are found. Many more of such activities carried out on a daily basis with the sole purpose of extracting materials for construction jobs are slowly but continuously exhausting the non-renewable resources as well as destroying the ecosystem.

## LITERATURE REVIEW

### **Petroleum contaminated soil**

In the Niger Delta Region, petroleum spillage is a major source of soil contamination. As emphasized by Ayininuola (2009), he stated that the major environmental concern in the Niger Delta region is the issue of petroleum spillage. Low income earners in this region sometimes have to contend with two prominent issues; the exorbitant fees attached to most houses available for rent and the use of soil for building construction which has been accidentally contaminated from petroleum spills. Most times, in the course of the extraction process, petroleum spills onto the ground surface. In addition, accidents, negligence, faulty equipments, old and unserviceable parts of equipments, etc. contribute to the petroleum spills that often occur in the region.

Oyelowe (2015); Ezeldin & Vaccri (1996); Adeoye, Olatokunbo & Ademola (2015); Rehman, Abduljawwad & Akram (2007) asserted that spilled petroleum does not remain on the surface but seeps into the ground under the influence of gravity contaminating the soil as it moves downwards. In this way, soils far away from the point of spillage may become contaminated as a result of the horizontal movement of the spilled petroleum when it comes in contact with underground moisture.

Studies carried out revealed that the presence of these spills in some ways contributed to the improved engineering properties of the soils investigated. Researchers like Onyelowe (2015), reported that contamination of engineering soils with up to 4% petroleum was beneficial in terms of soil improvement and stabilization. Again, Al-Sanad, Eid & Isamel (1995) as cited by Obeta & Ohwogonhwo (2015) revealed that 4% petroleum contamination increased the California bearing ratio of Kuwaiti sand. Also, Otunyo (2010) as quoted by Obeta et al. (2015) affirmed that the California bearing ratio of petroleum contaminated soils were higher than the uncontaminated soils of silty clay and sandy clay soils.

This implies that petroleum contaminated soils can be useful for building construction.

### **Compressed Earth Brick (CEB)**

To adequately utilize these contaminated soils for cheap and affordable building construction especially for low income earners, compressed earth bricks (CEBs) can be made from such soils. This reduces the overdependence on concrete and its constituent materials. Adam & Agib (2001), Stulz, Mukerji, Ile & Fur (1993) as quoted by Oyelami & Van Roov (2016, p. 2) defined compressed bricks/blocks as 'masonry which are small in size having regular characteristics and produced by static or dynamic compression of earth in humid state followed by immediate demoulding'.

Guillaud, Joffroy & Odul (1985) as well as Patowary, Nath, Hussain & Kakoti (2015) affirmed that the compressed earth brick/block (CEB) is the modern outcome of molded earth known as adobe earth block. CEB normally has a high compressive strength. This is due to the high mechanical force (mechanical stabilization) applied to moist soils during the production of bricks using a press to produce maximum compaction and eliminate or reduce the presence of air pores responsible for weakness. Numerous soil types can be used for CEB production but most times, laterite is usually the preferred choice. This according to Oyelami et al. (2016) is based on the fact that laterite is well graded consisting of cohesive and cohesionless parts of a soil.

### **Laterite soil stabilization**

Enaworu, Ugbe & Rotimi (2016) defined laterites as soils subjected to high weathering activities and composed of iron and aluminium oxides. Laterite, mostly a reddish brown soil has been utilized as a viable construction material. It is a building material that is as old as mankind. It is found in the inter tropical regions of Africa, India, South East Asia and South America where rainfall is high (Lemougna, Melo, Kamseu & Tchamba, 2011). The reddish-brown colouration is as a result of the presence of the oxide of iron which in combination with the oxides of silica and aluminium accounts for the bulk of the oxides present in laterite. The Niger Delta region has an abundant amount of laterite, some of which may have been contaminated through petroleum spills and hence, can possibly be utilized in building construction activities. Unfortunately, the utilization of laterite soils though in abundance is mostly limited to use in civil engineering works involving road construction and landfill operations (Joshua & Lawal, 2011).

To improve durability and strength of CEBs, a stabilizer such as cement is added in predetermined amount. The addition of the stabilizer results in the formation of a stronger and more durable material referred to as CSEB. A stabilizer improves both the strength and index properties of the soil making it useful for construction activities (Salahudeen & Akije, 2014 as quoted by Sadeeq, Ochepe, Salahudeen & Tijani, 2015). Other stabilizers such as pozzolans which can be substitute for cement or used partially with cement can as well help to improve soil properties. This is because studies carried out on pozzolans derived from the ashes of agricultural wastes and industrial by-products as well as from man's industrial activities such as welding has been shown to improve the strength of masonry bricks. Khalil (2017) acknowledged that many of these materials such as rice husk ash (RHA), furnace

slag, plant extracts and carbide waste are yet to be fully used in Nigeria apart from their utilization in laboratory works. Pozzolans generally are finely grounded materials and as revealed by Walker & Pavia (2011), they are rich in oxides of aluminium and silica which reacts with calcium hydroxide and moisture to create hydrated products of calcium silicate aluminium hydrate (CSAH) and calcium silicate hydrate (CSH). These hydrates are responsible for bond development. Masonry products such as CSEBs are durable, strong and very affordable and could be maximized for low cost building construction.

## RESEARCH QUESTION, MATERIALS, TESTS AND METHOD

### Research question

What is the effect of petroleum contamination on properties of CSEBs stabilized partially with cement, rice husk ash (RHA) and carbide.

### Materials

Laterite was sourced from Dan Bazariye opposite National Animal Production Research Institute (NAPRI) in Shika, located in Giwa local government area of Kaduna State, Nigeria. The laterite was collected at a depth of 1.53m, air dried in the laboratory and sieved with a wire mesh screen aperture of 9.5mm diameter. Soil particles that passed through the 9.5mm wire mesh screen aperture were utilized in the research. Other materials used included Portland Limestone Cement (PLC) of Dangote brand which conformed to BS 12, 1996, RHA conformed to ASTM C 593:2006 specification and carbide conformed to the requirement of ASTM C 141:2005. Water satisfied the requirements of BS 3148 (1990) and the petroleum gotten from Kaduna refinery in Kaduna State served as the contaminant for the bricks.

### Tests

Preliminary physical tests for the materials such as sieve analysis, percentage moisture content, atterberg and specific gravity were conducted based on the requirements of BS 1377 part 2: (1990). Proctor test (Light compaction test) according to the specifications of BS 1377 part 4: (1990) standard and bulk density test subject to BS 812 part 2: (1995) standard were undertaken. Furthermore, Free Swell Ratio (FSR) test put forward by Prakash & Sridharan (2004), Prakash, Sridharan, Prasanna & Manjunathe (2009) was carried out to determine the expansion or swell capability of the laterite.

In addition, chemical analysis to determine the mineralogical composition of oxides in the laterite, RHA and carbide using the XRF fluorescence spectrophotometer equipment was conducted. For the brick specimens, they were subjected to both dry and wet compressive strength tests, Abrasion, water absorption, sorptivity and ultrasonic pulse velocity (UPV) tests respectively.

### Method

As seen from table 2.1, the mix proportion comprised of 4% cement, 4% RHA and 2% carbide of the dry weight of the soil. This proportion was arrived at after numerous mix proportions used in the production of the trial CSEBs were subjected to dry compressive strength test to come up with the appropriate proportion. After the trial tests, three sets of CSEBs were produced. The first set of CSEBs had 2%

petroleum contamination, the second set 3% and the third set had 0% contamination which acted as the control for the 2% and 3% contaminated CSEBs.

**Table 2.1 Material proportions for petroleum contaminated 0%, 2% and 3% CSEBs**

S/N	Type of test	No of brick	Mass of cement (kg)	Mass of RHA (kg)	Mass of carbide (kg)	Mass of laterite (kg)	Mass of water (kg)	Mass of petroleum (kg)	Petroleum contamination (%)
1	Dry compressive strength	20	2.4	2.4	1.2	60	15.6	0	0
		20	2.4	2.4	1.2	60	15.6	1.2	2
		20	2.4	2.4	1.2	60	15.6	1.8	3
2	Wet compressive strength	20	2.4	2.4	1.2	60	15.6	0	0
		20	2.4	2.4	1.2	60	15.6	1.2	2
		20	2.4	2.4	1.2	60	15.6	1.8	3
3	Water absorption	15	1.8	1.8	0.9	45	11.7	0	0
		15	1.8	1.8	0.9	45	11.7	0.9	2
		15	1.8	1.8	0.9	45	11.7	1.35	3
4	Abrasion	15	1.8	1.8	0.9	45	11.7	0	0
		15	1.8	1.8	0.9	45	11.7	0.9	2
		15	1.8	1.8	0.9	45	11.7	1.35	3
5	Sorptivity	15	1.8	1.8	0.9	45	11.7	0	0
		15	1.8	1.8	0.9	45	11.7	0.9	2
		15	1.8	1.8	0.9	45	11.7	1.35	3
6	Ultrasonic Pulse velocity	15	1.8	1.8	0.9	45	11.7	0	0
		15	1.8	1.8	0.9	45	11.7	0.9	2
		15	1.8	1.8	0.9	45	11.7	1.35	3

In producing the CSEBs, a calculated amount of laterite, RHA, carbide and cement were mixed thoroughly until the mixture became homogenous. Next, water was added to the mixture to initiate the chemical reaction process for the cement, pozzolan and carbide in the mix before the calculated amount of petroleum was added to those mixes that were to be contaminated. The various mixes (2%, 3% and 0% contaminated CSEBs) were then loaded on to a Nigerian Building and Road Research Institute (NBRRI) brick moulding machine which produces a press or pressure of 4N/mm<sup>2</sup> (Ramson, 2011) for compaction. After compaction, the green bricks were extruded and taken to the curing area. Here, they were covered with plastic sheets to prevent rapid and excessive hydration from taking place. During the 28 days curing period, the bricks were watered daily by sprinkling to produce moisture for hydration as well as a warm and moist environment for curing under the polythene sheets. Five bricks for each test at an allotted test day were subjected to the outlined tests after which the averages of the 5 bricks were determined.

For the dry and wet compressive strength tests, CSEBs were crushed at 7, 28, 56 and 90 days respectively. Water absorption, sorptivity and abrasion tests were conducted at 28, 56 and 90 days. Lastly, UPV test was carried out on the bricks at 56 days and 90 days. No test was carried out on day 28 due to the late approval of the UPV equipment.



**Figure 1 Petroleum contamination of stabilized soil mix**



**Figure 2 Compaction of contaminated stabilized soil mix**



**Figure 3 Extruded green bricks (CSEB)**



**Figure 4 CSEBs covered with blue plastic sheet during curing**

Figures 1, 2, 3 and 4 show the various activities carried out to produce both the petroleum contaminated and non-contaminated CSEBs.

## RESULTS AND DISCUSSION

### Physical properties of laterite, RHA and Carbide

**Table 3.1 Physical properties**

Properties	Description		
	Laterite	RHA	Carbide
Natural moisture content (%)	15.38	-----	-----
Liquid limit (%)	38	-----	-----
Plastic limit (%)	20	-----	-----
Plastic index (%)	18	-----	-----
AASHTO Classification system	A-2-6	-----	-----
Bulk density (kg/m <sup>3</sup> )	1697	-----	-----
Specific gravity	2.76	2.14	2.48
Fineness modulus	3.48	-----	-----
Condition of sample	Air dried	Air dried	Air dried
Colour	Reddish-brown	Greyish-white	White
Silica-Sesquioxide ratio	1.50	-----	-----
Free swell ratio (FSR)	1.12	-----	-----
Optimum moisture content (OMC %)	15.79	-----	-----
Maximum dry density (MDD g/cm <sup>3</sup> )	1.84	-----	-----



From table 3.1, the natural moisture content for the laterite was 15.38% indicating a possible high bearing capacity property to withstand imposed load. Plasticity index was at 18% less than the maximum limit of 35%. This showed that the soil will not be prone to alternating swelling and shrinking when moist or dry. The soil falls under the sub-group of A-2-6 of the American Association of State Highways and Transportation Officials AASHTO M145-91 (2003) standard classification system showing the soil to be made up of sand, gravel with elastic silt fines. The bulk density and the specific gravity of the soil were 1697 kg/m<sup>3</sup> and 2.76. These values fall within acceptable ranges for laterite soils. Also, the specific gravity of the RHA and carbide were 2.14 and 2.48 respectively. The fineness modulus was 3.48 within the range of 2.0 - 3.5 indicating that the soil was mostly made up of fine aggregates. The samples were all dried before use to prevent caking of the particles by moisture. Oxide of iron was responsible for the reddish brown colouration of the laterite while reactive amorphous silica produced the greyish-white colour of the RHA and oxide of calcium influenced the whitish colour of the carbide.

According to Rossister (2014), the Silica – Sesquioxide ratio of a soil within the range of 1.33 and 2 is a true laterite hence this soil with a S-S ratio of 1.50 satisfied that requirement. The free swell ratio of this soil with a value of 1.12 can be said to have a mixture of kaolinite and montmorillonite clay components meaning the soil has a low expansivity. Lastly, 15.79% was the optimum moisture content at which the soil attained a maximum dry density of 1.84 g/cm<sup>3</sup>.

### Chemical properties of laterite, RHA and Carbide

**Table 3.2 Chemical constituents of laterite, RHA and carbide**

Element	Concentration (wt %)		
	Laterite	RHA	Carbide
Na <sub>2</sub> O	0.051	0.140	0.000
MgO	0.580	2.505	0.000
Al <sub>2</sub> O <sub>3</sub>	25.396	1.619	2.200
SiO <sub>2</sub>	56.996	82.831	6.740
P <sub>2</sub> O <sub>5</sub>	0.197	7.193	0.081
SO <sub>3</sub>	0.282	0.700	0.617
Cl	0.007	0.029	0.162
K <sub>2</sub> O	1.825	2.111	0.120
CaO	0.211	1.497	89.435
TiO <sub>2</sub>	1.946	0.118	0.074
Cr <sub>2</sub> O <sub>3</sub>	0.019	0.002	0.004
Mn <sub>2</sub> O <sub>3</sub>	0.081	0.268	0.007
Fe <sub>2</sub> O <sub>3</sub>	12.399	0.925	0.507
ZnO	0.001	0.054	0.000
SrO	0.009	0.008	0.054

From table 3.2, elements in the laterite soil that have an appreciable amount of oxides include Aluminium, Silica and Iron with corresponding percentage values of 25.39%, 56.99% and 12.39% in that order. The RHA had a very high silica content (amorphous silica) of 82.83% which is highly desirable for any pozzolanic material

to possess with regards to the reaction expected to occur with calcium oxide in the presence of water. For the carbide, the oxide of calcium with a value of 89.43% was the most prominent among all the other oxides present in the carbide.

## MECHANICAL AND DURABILITY TEST RESULTS

### Dry Compressive Strength

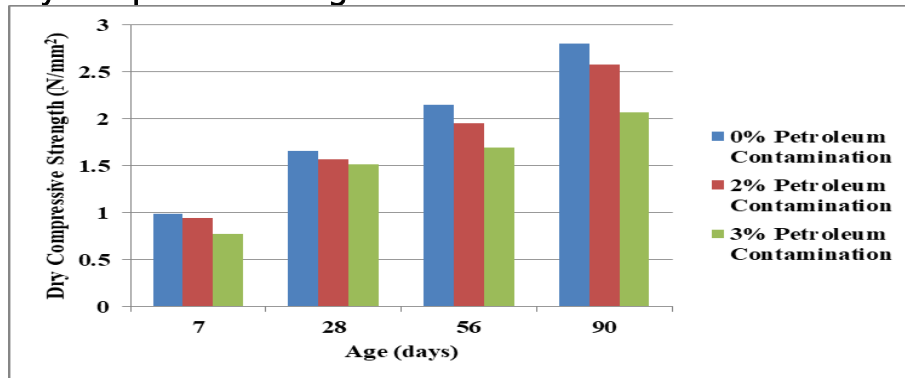

Fig 5: Dry compressive strength – age of curing relation for CSEBs

For the earliest average strength at day 7, 2% petroleum contaminated CSEBs achieved an average dry compressive strength of 0.94 N/mm<sup>2</sup>, 3%; 0.77 N/mm<sup>2</sup> and 0%; 0.99 N/mm<sup>2</sup>. For strength at 28 days, the Nigerian Building and Road Research Institute (2006) recommended a dry compressive strength of not less than 2.0 N/mm<sup>2</sup> at 5% cement stabilization. Average compressive strength of the bricks at 2%, 3% and 0% were however 1.57 N/mm<sup>2</sup>, 1.51 N/mm<sup>2</sup> and 1.66 N/mm<sup>2</sup> respectively. It was on day 56 that 0% bricks achieved the 28 days strength with an average value of 2.15 N/mm<sup>2</sup>. Furthermore, at day 90, 2% and 3% were finally able to achieve the 28 days strength with 2.58 N/mm<sup>2</sup> and 2.07 N/mm<sup>2</sup>. The 2% and 3% bricks achieved their strength late (90 days) because the bonds that were being developed in the brick's matrix between the aggregates was from the hydration of the cementing gels slowing down due to the encapsulation activity of the petroleum contamination. However, this did not prevent the contaminated bricks from reaching the 2.0 N/mm<sup>2</sup> 28 days strength recommended. This is in line with Tremblay, Duchesne, Locat & Leroveil (2002) as quoted by Akinwumi, Booth, Diwa & Mills (2016) that petroleum contaminants found in cement stabilized soils slows down hydration but cannot prevent the development of the ultimate strength of the stabilized petroleum contaminated soils.

Presses with higher compaction pressure can be used for petroleum contaminated soils to make bricks which will in turn lead to the contaminated bricks achieving close to the 28 days compressive strength specified by NBRRI (2006). This is because the higher the compaction pressure generated in the brick's matrix, the closer and stronger will be the bond created between the aggregates despite the presence of the petroleum contaminants in the brick's matrix. This implies that soils having petroleum content higher than 3% can be used as long as a press with a very high compaction pressure is utilized in the brick production. This agrees with Abdullah, Nagapan, Antonyova, Rasiah, Yunus & Sohu (2017) when they affirmed that an increase in compaction pressure would give rise to an increase in compressive strength of CSEBs.

### Wet Compressive Strength

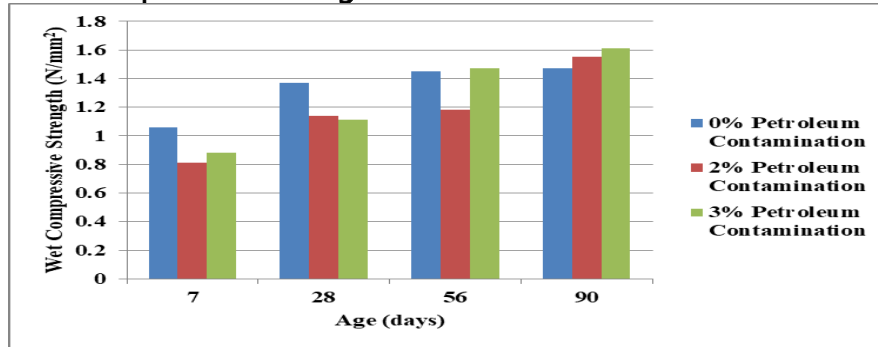

Fig 6: Wet compressive strength – age of curing relation for CSEBs

The value of 1.0N/mm<sup>2</sup> specified by NBRRI (2006) and between the range of 0.2N/mm<sup>2</sup> to 0.6N/mm<sup>2</sup> also specified by National Building Code (NBC 2006) as the minimum 28 days wet compressive strength for cement stabilized bricks were satisfied by the 0% bricks (1.37N/mm<sup>2</sup>), 2% bricks (1.14N/mm<sup>2</sup>) and 3% bricks (1.11N/mm<sup>2</sup>) which were tested at 28 days. The graph showed that an increase in petroleum contamination lead to a significant increase in strength as the ages of the bricks increased. This was very much evident at 90 days when the average wet strength of the 2% bricks (1.55N/mm<sup>2</sup>) and 3% bricks (1.61N/mm<sup>2</sup>) surpassed that of the 0% bricks (1.47N/mm<sup>2</sup>).

From this, it can be deduced that the petroleum contamination hindered the ingress of moisture into the contaminated brick’s matrix. This result agrees with the assertion of Onyelowe (2015) as well as with Al-Sanad et al. (1995) as quoted by Obeta et al. (2015) when they concluded from their studies that 4% petroleum contamination improved the engineering properties of soil. It also agrees with the conclusion drawn by Otunyo (2010) as cited by Obeta et al. (2015) that silty clay and sandy clay soils with petroleum contamination had higher California bearing ratio than those without petroleum contamination. The petroleum contaminants occupied available pore spaces in the brick’s matrix which were not occupied by the cementing gels. For the 0% bricks, the absence of the contaminants made ingress of water into the brick’s matrix easy thereby creating paths of weakness during crushing.

### Abrasion

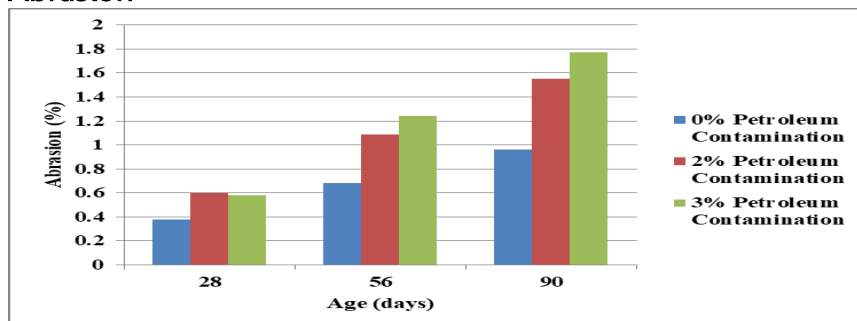

Fig 7: Abrasion – age of curing relation for CSEBs

The wearing off action was more prominent on the 2% bricks (28 days; 0.60%, 56 days; 1.09%, 90 days; 1.55%) and 3% bricks (28 days; 0.58%, 56 days; 1.24%, 90 days; 1.77%) than on the 0% bricks (28 days; 0.38%, 56 days; 0.68%, 90 days; 0.96%). The 3% bricks having the highest amount of contamination produced more wear

offs due to the influence of the petroleum contaminants in preventing the formation of some bonds between aggregates. The encapsulation of the aggregates by the petroleum contaminants lead to the cementing gels in the brick's matrix forming some weak bonds between the aggregates. Also, the electrostatic forces of attraction between the contaminants and the aggregates were not as strong as the forces that existed between the cementing gels and aggregates. As a result, the abrasive force applied were sufficient in dislodging those aggregates with weaker bonds attached to them as the bricks continued to age. The 0% bricks had the least wear off because it was difficult for the aggregates to be removed from the brick's matrix due to the absence of the petroleum contaminants which would have encapsulated the aggregates and weakened the bonds created.

### Water absorption

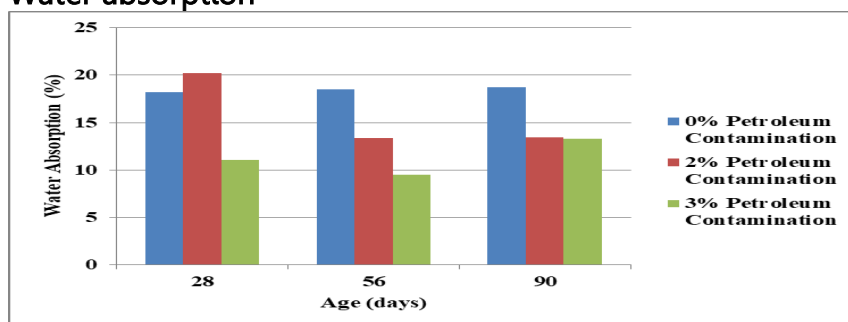

Fig 8: Water absorption – age of curing relation for CSEBs

The graph in fig 8 showed a very slow but steady increase in water absorption for the 0% bricks from 28 days (18.20%), 56 days (18.51%) to 90 days (18.72%) in that order. This probably could have been due to the high affinity of RHA for moisture. In the case of the 2% and 3% bricks, there was a drop in water absorption at 56 days (2%; 13.38%, 3%; 9.51%) from the initial average absorption values recorded at 28 days (2%; 20.23%, 3%; 11.07%) before a slight jump in average absorption was recorded at 90 days (2%; 13.46%, 3%; 13.31%). It was at this time that the water absorption of the bricks began to stabilize. The petroleum contamination sealed available air pores in the brick's matrix preventing the flow of moisture into the brick as was similarly observed during the wet compressive strength test. Also, as hydration slowed down due to the reduction in the amount of available cementing gels present in the pores, spaces not yet occupied by the gels were taken over by the contaminants which contributed immensely to the drop in water absorption.

### Sorptivity

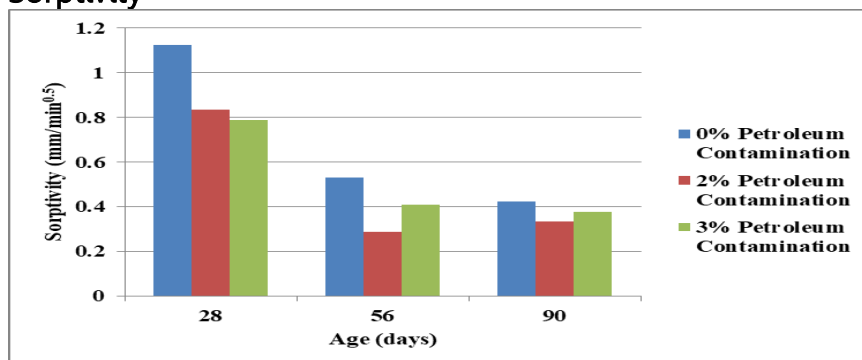

Fig 9: Sorptivity – age of curing relation for CSEBs

This test was conducted at intervals of 0, 2, 4, 8, 20, 30 and 60 minutes respectively for each brick at each allotted test day before computing the average sorptivity. At 28 days, the sorptivity test showed that 0% bricks had the highest average capillary absorption value of 1.124mm/min<sup>0.5</sup> followed by the 2% bricks with a value of 0.835mm/min<sup>0.5</sup> and the least being the 3% bricks with average capillary value of 0.790mm/min<sup>0.5</sup>. The drop in capillary absorption continued all the way to 90 days for the 0% brick (0.423mm/min<sup>0.5</sup>) and 3% bricks (0.376mm/min<sup>0.5</sup>). However, there was a slight spike in capillary absorption for 2% bricks (0.335mm/min<sup>0.5</sup>) at 90 days from that recorded at 56 days (0.287mm/min<sup>0.5</sup>). Overall, all bricks recorded a considerable drop in capillary absorption despite the 0% bricks which recorded the highest average value on all test days. For the contaminated bricks, the presence of the petroleum contaminants made the ingress of water into the brick's matrix difficult.

### Ultrasonic pulse velocity

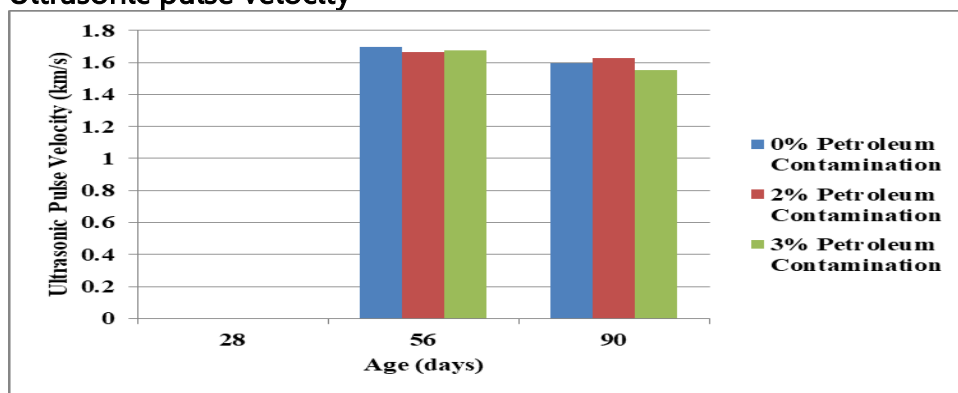

Fig 10: Ultrasonic pulse velocity – age of curing relation for CSEBs

No test was conducted at 28 days hence, the zero value seen on the graph. At day 56, average UPV values recorded for 0%, 2% and 3% bricks were 1.700km/s, 1.668km/s and 1.678km/s respectively. At 90 days, a slight drop in average UPV values for 0% (1.596km/s), 2% (1.627km/s) and 3% (1.553km/s) bricks were recorded. This test signified that the presence of the petroleum contamination did not have any significant effect on the UPV of the contaminated bricks (2% and 3%) when compared to the uncontaminated bricks (0%). The low values revealed the presence of an appreciable amount of air pores which might be present in the brick's matrix. This implies that a higher compaction pressure more than the pressure used in the production of the bricks (4N/mm<sup>2</sup>) would be necessary so as to have higher UPV values.

## CONCLUSIONS

Laterite containing petroleum contaminant can be used in the production of CSEBs. Bricks made from petroleum contaminated laterite (2% and 3%) performed favourably and even surpassed the performance of the uncontaminated bricks (0%) especially during the water related tests. This shows that the petroleum contaminated bricks have the potential to perform optimally than the uncontaminated bricks in a moist environment such as the Niger Delta region of Nigeria where petroleum contaminated laterite is found. The dry compressive strength gains of the petroleum contaminated bricks were slow when compared with the uncontaminated bricks. However, the contaminated bricks were able to

achieve their ultimate 28 days strength but at a later day. Higher compaction pressures for the production of CSEBs with higher petroleum contamination therefore shows promising possibilities for petroleum contaminated laterite.

## REFERENCES

- AASHTO M145-91 (2003). Standard specification for classification of soils and soil-aggregate mixtures for highway construction purposes. American Association of State Highways and Transportation Officials. Washington D.C., U.S.A.
- Abdullah, A., Nagapan, S., Antonyova, A., Rasiah, K., Yunus, R., & Sohu, S. (2017). Strength and absorption rate of compressed stabilized earth bricks (CSEBs) due to different mixture ratios and degree of compaction. MATEC Web of Conferences, no. 103, pp. 1-8
- Adam, E. A. & Agib, A. R. A. (2001). Compressed stabilized earth block manufacture in Sudan. United Nations Educational, Scientific and Cultural Organization. 7 Place de Fontenoy, 75352 Paris 07 SP, France.
- Adeoye, O., Olatokumbo, O., & Ademola, A. (2015). Effect of crude oil contamination on the index properties, strength and permeability of laterite soil. New York Science Journal. vol. 8, no. 10, pp. 82-86.
- Akinwumi, I. I., Booth, C. A., Diwa, D., & Mills, P. (2016). Cement stabilization of crude oil contaminated soil. Proceedings of the ICE-Geotechnical Engineering, vol. 169, no. 4, pp. 336-345.
- Al-Sanad, H. A., Eid, W. K., & Isamel, N. F. (1995). Geotechnical properties of oil contaminated Kuwaiti sand. Journal of Geotechnical Engineering, vol. 121, no. 5, pp. 407-412.
- Aminu, G. W., & Ruhizal, R. (2013). Housing policies and programmes in Nigeria: A review of the concept and implementation. Business management dynamics, vol. 3, no. 2, pp. 60-68.
- ASTM C 141: 05. Standard specification for hydraulic hydrated lime for structural purposes. American Society for Testing and Materials International, 100 Barr Harbour Drive, PO Box C700, West Conshohocken, PA, 19428-2959, USA.
- ASTM C 593: 06. Standard specification for fly ash and other pozzolans for use with lime for soil stabilization. American Society for Testing and Materials International, 100 Barr Harbour Drive, PO Box C700, West Conshohocken, PA, 19428-2959, USA.
- Ayininuola, G. M. (2009). Influence of diesel oil and bitumen on compressive strength of concrete. Journal of Civil Engineering (IEB), vol. 37, no. 1, pp. 65-71.
- BS 12. (1996). Specification for Portland Cement. British Standard Institution, London, UK.
- BS 1377: Part 2 (1990). Methods of tests for soils for civil engineering purposes. British Standard Institution, London, UK.
- BS 1377: Part 4 (1990). Methods of test for soils for civil engineering purposes. Compaction - related tests. British Standard Institution, London, UK.
- BS 3148. (1990). Standard for quality of mixing water. British Standard Institution, London, UK.
- BS 812: Part 2 (1995). Testing aggregate. Methods for determination of bulk density. British Standard Institution, London, UK.

- BS EN 12390: Part 3 (2009). Testing hardened concrete. Compressive strength of test specimens. British Standard Institution, London, UK.
- Enaworu, E., Ugbe, F. C. & Rotimi, O. J. (2016). The geochemistry and geotechnical (compaction) analysis of laterite soils: A case study of Okpanam Area. *AshEse Journal of Engineering*. Vol. 2, no. 3, pp. 75-82.
- Ezeldin, H. S., & Vaccari, D. A. (1996). Organic emissions from petroleum contaminated soil fixed in concrete. *Journal of Soil Contamination*, vol. 5, no. 1, pp. 35-52.
- Guillaud, H., Joffroy, T., & Odul, P. (1985). *Compressed Earth Block: Manual of Design and Construction, Volume II*. A Publication of the Deutsches Zentrum für Entwicklungstechnologien – GATE in: Deutsche Gesellschaft Für Technische Zusammenarbeit (GTZ) GmbH in Coordination with BASIN.
- Joshua, O., & Lawal, P. O. (2011). Cost Optimization of Sandcrete Blocks through Partial Replacement of Sand with Lateritic Soil. *Epistemics in Science, Engineering and Technology*, vol. 1, no. 3, pp. 89-94
- Khalil, I. M. (2017). Performance based evaluation of cassava starch and makuba matrix for the stabilization of compressed earth brick. Unpublished Doctoral Thesis, Department of Building, Ahmadu Bello University.
- Lemougna, P. N., Melo, U. F. C., Kamseu, E., & Tchamba, A. B. (2011). Laterite based stabilized products for sustainable building application in tropical countries: Review and prospects for the case of Cameroon. *Sustainability*. Vol. 3, pp. 293-305.
- National Building Code. (NBC 2006). *Building Regulations*. Ohio : Lexis Nexis Butterworths.
- Nigeria Building and Road Research Institute (NBRRI 2006). NBRRI interlocking block making machine. *NBRRI Newsletter*, vol. 1, no. 1, pp. 15–17.
- Obeta, I. N., & Ohwoghanohwo, J. (2015). Application of used engine oil in soil - cement stabilization. *Nigerian Journal of Technology (NIJOTECH)*, vol. 34, no. 1, pp. 104-108.
- Onyelowe, K. C. (2015). Pure crude oil contamination on Amaoba lateritic soil. *EJGE*, vol. 20, no. 3, pp. 1129-1142.
- Otunyo, A. W. (2010). Reduction of the shear strength of soils in the NigerDelta area of Nigeria due to crudeoil production. *Nigerian Journal of Technology*, vol. 29, no. 2, pp.130-140.
- Oyelami, C. A., & Van Rooy, J. L. (2016). A review of the use of lateritic soils in the construction/development of sustainable housing in Africa: A geological perspective. *Journal of African Earth Sciences*, vol. 119, pp. 1-12.
- Patowary, B. N., Nath, N., Hussain, I., & Kakoti, H. J. (2015) Study of compressed stabilized earth block. *International Journal of Scientific and Research Publication*. Vol. 5, no. 6, pp. 1-4
- Prakash, K., & Sridharan, A. (2004). Free swell ratio and clay mineralogy of fine-grained soils. *Geotechnical Testing Journal*, vol. 27, no. 2, pp. 220-225.
- Prakash, K., Sridharan, A., Prasanna, H. S. & Manjunatha, K. (2009). Identification of soil clay mineralogy by free swell ratio method. *IGC, Guntur, India*. pp. 27-30.
- Ramson, P. P. (2011). The effect of varying range of soil grain sizes on cassava starch stabilized compressed earth. Unpublished Bachelor of Science Project, Department of Building, Faculty of Environmental Design, Ahmadu Bello University, Zaria, Nigeria.

- Rehman, H. U., Abduljawad, S. N., & Akram, T. (2007). Geotechnical behaviour of oil-contaminated fine grained soils. *Electronic Journal of Geotechnical Engineering (EJGE)*. Pp. 1-12.
- Rossiter, D. G. (2004). Digital soil resource inventories: Status and prospects. *Soil use and Management*, vol. 20, no. 3, pp. 296-301.
- Sackey, K. A. N., Garba, M. M., Mamman, M. & Adeleke, B. K. (2018). Assessing the flexural strength of stabilized poured laterite beams reinforced with three strand polypropylene rope. *Environ. Journal of Environmental Studies*, vol. 4, no. 6, pp. 13-23.
- Sackey, K. A. N., Garba, M. M., Mamman, M. & Adeleke, B. K. (2019). Strength properties of cement stabilized poured laterite. *SetJet. Journal of Environmental Technology*, vol. 1, no. 1, pp. 29-36.
- Sadeeq, J. A., Ochebo, J., Salahudeen, A. B., Tijjani, S. T. (2015). Effect of bagasse ash on lime stabilized laterite soil. *Jordan Journal of Civil Engineering*. vol. 9, no. 2, pp. 203-213.
- Salahudeen, A. B., & Akije, I. (2014). Stabilization of highway expansive soils with high loss on ignitions content kiln dust. *Nigerian Journal of Technology (NIJOTECH)*, vol. 33, no. 2, pp. 141-148.
- Stulz, R., Mukerji, K., Ile, S. K. & Fur, A. T. (1993). *Appropriate building materials: A catalogue of potential building solutions*, SKAT, Intermediate Technology Publishing, Gallen (London).
- Tremblay, H., Duchesne, J., Locat, J. & Leroveil, S. (2002). Influence of the nature of organic compounds on fine soil stabilization with cement. *Canadian Geotechnical Journal*, vol. 39, pp. 535-546.
- Walker, R. & Pavia, S. (2011). Physical properties and reactivity of pozzolans and their influence on the properties of lime-pozzolans paste. *Materials and Structures*. Vol. 44, pp. 1139-1150.





## EFFECTS OF MAXIMUM AGGREGATE SIZES ON FLEXURAL STRENGTH OF RECYCLE IRON AND STEEL SLAG CONCRETE

Oluwaleke Adekunle Olowu<sup>1</sup>, Akeem Ayinde Raheem<sup>2</sup>, Abiodun Yesiru Akinsanya<sup>3</sup> and Victor Ikechukwu Opara<sup>4</sup>

<sup>1</sup>*Department of Building Technology, School of Environmental Studies, Yaba College of Technology, Yaba, Lagos, Nigeria*

<sup>2</sup>*Department of Civil Engineering, Faculty of Engineering and Technology, Ladoko Akintola University of Technology, Ogbomoso, Nigeria*

<sup>3</sup>*Department of Building Technology, School of Environmental Studies, Lagos State Polytechnic, Ikorodu, Lagos, Nigeria*

<sup>4</sup>*Department of Quantity Surveying, Lagos State Polytechnic, Ikorodu, Lagos, Nigeria*

The needs for sustainable development to meet the increasing demand of granite for infrastructural development couple with environmental degradation and pollution caused by depletion of natural igneous deposit. Studies on structural integrity of recycled iron and steel slag (RISS) as aggregate in concrete have not been adequately investigated especially flexural characteristics of RISS concrete. The study adopted experimental approach to evaluating the effects of maximum aggregate sizes (MAS) on flexural strength of RISS concrete. Laboratory tests conducted on both granite and RISS aggregate include aggregate crushing value (ACV), aggregate impact value (AIV), Sieve analysis and X-ray fluorescence (XRF); flexural strength test was conducted on the concrete prism. Two sets of 600mm × 150mm × 150mm concrete prism were cast viz control and treatment; treatment concrete contains RISS aggregate at 10, 20, 40 and 60 % replacement level. The concrete prism were subjected to flexural strength test at 28 day curing. The results obtained for ACV, AIV and Sieve analysis showed that RISS aggregate are durable, tough, hard and well graded. Flexural strength values for mix ratios 1:1½:3, 1:2:4 and 1:3:6 ranges from 0.229 – 0.255 MPa, 0.210 – 0.219 MPa and 0.152 – 0.215 MPa for treatment concrete and 0.225 – 0.234 MPa, 0.202 – 0.205 MPa, and 0.134 – 0.174 MPa for control concrete these values were within the values of 0.130 – 0.250 MPa specified by BS 8500 -2: 2015. In conclusion flexural strength for both concrete increases as the maximum aggregate size decreases. RISS concrete can be use in road pavement and where high flexural strength is required.

Keywords: flexural strength, maximum aggregate size, riss aggregate, steel slag, x-ray fluorescence

<sup>1</sup> oluwaleke.olowu@yabatech.edu.ng

<sup>2</sup> aaraheem@lautrech.edu.ng

<sup>3</sup> engrabiodun@yahoo.com

<sup>4</sup> primewaters@yahoo.com

## INTRODUCTION

Demand for granite aggregate used in many Building and Civil Engineering works have been on the increase due to Industrial revolution and Technological advancement in the production and manufacturing of tools and machines for obtaining granite. Depletion of stock of natural igneous rock which is the source of granite aggregate on daily basis is cause for concern as it resulted into environmental degradation and pollution hence the introduction of alternative aggregate to granite.

Alternative aggregate to granite include Conditioned Pulverised Fuel Ashe (PFA) was investigated by Dhir, McCarthy and Tittle (2000); Textile waste sludge by Kulkarni et al. (2012) and Copper slag by Alnuaimi (2012) to mention but a few. Recycled Iron and Steel Slag (RISS) aggregate which is the focus of this study is industrial by-product generated from the production of iron and steel products from iron and steel scraps which litters our towns and cities instead of from iron-ore which is derived from the earth. The supply of iron-ore suffer setback from the iron and steel beneficiation plant located at Itakpewhich is down and unable to supply iron ore to the two Integrated Steel companies namely: Ajaokuta Steel Company, Ajaokuta, Ogun State and Delta Steel Company, Ovwian, Aladja, Delta State and the supplies from Brazil and Liberia is epileptic and unable to supply billets to the three governments owned inland rolling mills in Oshogbo, Kastina and Jos (Mohammed, 2002). Hence the rolling mills resorted to the use of waste scrap of iron and steel referred to as RISS aggregate.

Study by Norgate et al. (2007) show that production of iron and steel via blast furnace slag / converter / electric arc furnace requires energy demand of 23 Mj/kg and global warming pontifical of 2.3 kg Co<sub>2</sub>/kg. Fenton (2002) reported that using recycled steel saves 75% of energy, 90% of raw materials, reduces air pollution by 86%, water use by 40%, water pollution by 76% and mining wastes by 97%.

Similar study by Raheem et al. (2021) evaluated the effects of Water Cement Ratio on Strength Characteristics of Concrete Produced with Recycled Iron and Steel Slag Aggregate; Rao and Bhandare (2014) investigated the application of blast furnace slag sand in cement concrete; the study involve Granulated Blast Furnace Slag (GBFS) sand application as a partial substitute for Crushed Stone Sand (CSS) in cement concrete. Kothai and Malthy (2014) considered the utilization of steel slag as partial replacement for fine aggregate in M20 concrete grade. Khalid et al. (2014) conducted study using iron slag aggregate replacement for granite aggregate in M40 concrete grade. This study evaluates the effects of maximum aggregate sizes on flexural strength of recycled iron and steel slag (RISS) concrete. Though, standards and specifications to slag aggregate usage have been established such as BS EN 12620: 2002 for Air-cooled Blast Furnace Slag and JIS A5011-1:2013 for Slag Aggregate Concrete; more research are needed to be carried out to established the structural integrity of RISS concrete in relation to its strengths.

## EXPERIMENTAL PROCEDURE

### Materials

Materials used for this study includes: RISS aggregate and granite aggregate as (coarse aggregate), sharp sand (fine aggregate), Ordinary Portland Cement, OPC (cement) and water.

RISS aggregate was sourced from Major Engineering Company, Ikorodu referred to as RISS A; Selsa metal, Otta referred to as RISS B and Continental Iron and Steel Company, Ikeja referred to as RISS C. The RISS aggregate were crushed and sieved into three maximum aggregate sizes 37.5, 20 and 12 mm; One third of each RISS aggregate maximum aggregate sizes (MAS) was thoroughly mixed together and used for the study.

Sharp sand for the study was obtained from Ogun River at Owode. Granite aggregate was obtained from Ratcon Limited quarry site along Lagos - Ibadan expressway, sieved into the three maximum aggregate sizes (MAS) of 37.5, 20 and 12 mm. OPC used as the binding agent for the study complied with NIS 444-1: 2003. The cement was sourced from Lafarge Cement Company, Ewekoro, Ogun State, Nigeria. Water for the study was obtained from the tap at the Construction Workshop, Nigeria Building and Road Research Institute (NBRRI), Otta, Ogun State. The water was free of dirt and impurities.

### Specimen preparation

The specimens (RISS and granite aggregate) for X ray fluorescence (XRF) were crushed and sieved into three maximum aggregate sizes 37.5, 20 and 12 mm; One third of each RISS and granite aggregate maximum aggregate sizes (MAS) was thoroughly mixed together. Specimens for ACV and AIV tests (RISS and granite) were dried, crushed and passed through 12.5 mm sieve and retained on 10 mm sieve. The materials for concrete were batched, mixed and cast into rectangular prism moulds of size 600 mm × 150 mm × 150 mm; the concrete specimens were de-moulded after 24 hours, cured at temperature of 250C + 20C as per BS EN 12390 Part 2 (2000) in curing tank until testing date for flexural strength tests. Total of 135 concrete beams were cast.

### X-Ray Fluorescence (XRF)

XRF was used to determine the percentage oxide composition in the samples of the aggregate; the test conforms to BS EN ISO 12677 (2011). The prepared samples of RISS A, B and C were excited with x-ray; and consequently their atoms were ionized, electrons were ejected from the lower energy level which are K and L energy levels which were replaced from an outer higher energy level; energy were released because of decrease binding energy of the inner electron orbital compared to the outer energy orbital. The energy released according to the types of atom present in the sample was of the form of emission of characteristic x-rays. Wavelength dispersive spectrometer was used because complex emitted x-ray of elements was present in the samples. The intensity of the wavelength emitted by the x-ray was measured using both gas flow proportional and scintillation detectors. The gas flow detector measure long wavelength greater than 0.15 nano-micron which are x-ray of K spectra and element lighter than zinc; while scintillation detector was used to analyze shorter wavelengths in the x-ray spectrum which

includes element from Niobium (Nb) to Iodine (I) of the K spectra; Thorium (Th) and Uranium (U) of the L spectra. X-rays of middle wavelength were measured using both detectors in tandem. The exact value of each element was derived by comparing with mineral or rock standards whose composition is known using other techniques.

#### **Aggregate Crushing Value (ACV) test**

The ACV test was carried out as prescribed by BS EN 1097-2: 1998; the prepared samples of RISS and granite aggregate were filled in cylindrical moulds measure 11.5 cm in diameter and 18 cm high in three layers, each layer was tamped with a standard rod 25 times. The test samples were weighed (W1) and placed in the test cylinders (15.2 cm diameter). The specimens were subjected to compressive load of 40 tonnes (400 kN) gradually applied in 10 minutes. The materials passing through 2.36 mm sieve were separated and weighed (W2). The weight of these materials (fines), expressed as a percentage of the weight of the total sample (W1), gives the aggregate crushing value (ACV).

#### **Aggregate Impact Value (AIV) test**

The AIV test was carried out as prescribed by BS 812-112: 1990 and BS EN 1097 – 2: 1998; the prepared samples (RISS and granite aggregate) were filled into cylindrical moulds, 10.2 cm internal diameter and 5 cm height in three layers, each layer being given 25 strokes with a rod. The impact was provided by dropping a hammer of weight 14.0 kg through a height of 380 mm. The samples were transferred to the cups of aggregate impact testing machine and were tapped 25 times with the rod. The crushed aggregate were sieved on 2.36 mm sieve, the weight (W1) of materials passing through 2.36 mm sieve expressed as a percentage of the total weight (W2) of the sample gives the aggregate impact value. Aggregate Impact value is expressed as the ratio of weight of materials passing through 2.36 mm (W1) to the total weight (W2) of the samples.

#### **Sieve analysis (gradation)**

In coarse aggregate analysis a predetermined quantity (weight) of prepared samples (RISS and granite) aggregate was put on top of set of 50, 37.5, 28, 20, 14, 12, 10, 6.3 and 2.36 mm British Standard (BS) sieves placed one over the other in the order of their aperture, the largest aperture sieve was placed at the top and the smallest aperture sieve at the bottom. A receiver was placed at the bottom, and a cover at the top of the whole assembly, the whole assembly was fitted on a sieve shaking machine. Shaking was done for 10 minutes; the portion of the sample that was retained on each sieve was weighed. The percentage of sample retained on each sieve was calculated on the basis of total weight of sample, and from these results, percentage passing through each sieve was calculated.

#### **Flexural strength test**

Flexural strength test was carried out as prescribed by BS EN 12390: Part 5: 2000 the machine used conforms to (pr EN 12390: Part 4: 2000). The third point loading of the machine was set-up, the specimen (600 mm × 150 mm × 150 mm) concrete beam was put in place; the actuator gradually released the load steadily and without shock at  $0.06 \pm 0.04$  N/ (mm<sup>2</sup> s). The rate of loading was maintained without change until failures occur. The result was read off from the analogue

screen and tabulated. The flexural strength was calculated as shown in equation 1, 135 concrete beams were tested for flexural strength.

$$F_{cf} = \frac{F \times L}{d_1 \times d_2^2} 1$$

## RESULTS AND DISCUSSION

### X-Ray Fluorescence (XRF)

Table 1 show the result of X-ray fluorescence on samples of RISS and granite aggregates; from the table, it can be observed that the predominant oxides in RISS aggregate are: Calcium oxide (CaO), Iron II oxide (FeO), Silicon oxide (SiO<sub>2</sub>) and Iron III oxide (Fe<sub>2</sub>O<sub>3</sub>) in the following proportions 45.16, 24.08, 13.70 and 10.32 %, 40.22, 18.78, 10.10, and 13.76 %, 46.30, 18.85, 15.09 and 10.08 % for RISS A, B and C respectively. Granite aggregate has Silicon oxide (SiO<sub>2</sub>), Iron III oxide (Fe<sub>2</sub>O<sub>3</sub>), and Potassium oxide (K<sub>2</sub>O) and Sodium oxide (Na<sub>2</sub>O) as predominant oxides with 70.20, 11.56, 3.41 and 3.28 % respectively. The metallic elements in the oxides of RISS aggregates are more ductile in nature, ability to be drawn into wire, hence concrete produced with RISS aggregate are likely to have high tensile strengths compared with granite aggregate.

From the presented result it was observed that the oxides in RISS aggregate which are in high percentage are contained in low percentage in the granite aggregate; CaO and FeO were predominant in RISS while SiO<sub>2</sub> and Fe<sub>2</sub>O<sub>3</sub> were the predominant oxide in the granite aggregate which attested to the differences in their physical and chemical properties though both contained non reactive silicon oxide which makes RISS aggregate better and an alternative to granite aggregate (Nippon Slag Association, 2015). The result of this study confirms the result of similar study by Olonade et al. (2015) that the chemical composition of steel slag includes SiO<sub>2</sub> (42 %), Ferric oxide Fe<sub>2</sub>O<sub>3</sub>(32 %), CaO (5 %) and K<sub>2</sub>O (2 %). Yongchang et al. (2019) reported that the major constituent of steel slag are Di calcium Silicate (C<sub>2</sub>S), Tri calcium silicate (C<sub>3</sub>S) and Tetra calcium aluminates (C<sub>4</sub>AF) which are major constituent of cement participated in hydration process and enhance the strength of concrete; the oxide of these compounds were confirmed present in the RISS aggregate used by this study.

Tahir and Ana (2011) identified the following minerals in steel slag which include Wustite (FeO), Calcium ferrite CaFe<sub>2</sub>O<sub>4</sub>/ (CF); Screbrodolskite Ca<sub>2</sub>Fe<sub>2</sub>O<sub>5</sub>/ (C<sub>2</sub>F); Larnite Ca<sub>2</sub>SiO<sub>4</sub>/ (C<sub>2</sub>S); Alite Ca<sub>3</sub>SiO<sub>5</sub>/ (C<sub>3</sub>S); Mayenite Ca<sub>12</sub>Al<sub>14</sub>O<sub>33</sub>/ (C<sub>12</sub>A<sub>7</sub>) and Brownmillerite Ca<sub>2</sub>Al<sub>2</sub>Fe<sub>2</sub>O<sub>5</sub>/ (C<sub>4</sub>AF) using XRD analysis; Wang et al. (2013) reiterated that steel slag aggregate consist of C<sub>2</sub>S, C<sub>3</sub>S, phase CaO, FeO, MgO, MnO and C<sub>2</sub>F. Sezer and Gulderen (2015) identified the major elemental composition of the steel slag to include Iron III oxide (Fe<sub>2</sub>O<sub>3</sub>), Calcium oxide (CaO), Silicon oxide (SiO<sub>2</sub>) and Aluminum Oxide (Al<sub>2</sub>O<sub>3</sub>) which was in the following proportion 35.22,24.62, 17.79 and 7.82 percent. This study confirms the findings of the aforementioned studies on the oxides present in the RISS aggregate. From all indications RISS aggregate contains similar composition in different proportions and non reactive silica.

**Table 1: Chemical composition of RISS and granite aggregates samples**

S/N	PARAMETER	LEVEL DETECTED (%)				AVERAGE VALUE	GRANITE
		RISS A	RISS B	RISS C			
1.	Colour	Dark Brown Solid	Black Solid	Dark Brown Solid		Grey Solid	
2.	SiO <sub>2</sub>	13.70	10.10	15.09	12.96	70.20	
3.	Al <sub>2</sub> O <sub>3</sub>	1.68	1.02	1.72	1.47	11.56	
4.	Fe <sub>2</sub> O <sub>3</sub>	10.32	13.76	10.08	11.39	1.19	
5.	FeO	24.08	18.78	18.85	20.57	1.12	
6.	CaO	45.16	40.22	46.30	43.89	0.96	
7.	MgO	7.31	5.32	7.15	6.59	0.75	
8.	Na <sub>2</sub> O	0.19	0.04	0.22	0.15	3.28	
9.	K <sub>2</sub> O	0.04	0.01	0.05	0.03	3.41	
10.	S	0.03	0.01	0.04	0.03	0.00	
11.	P <sub>2</sub> O <sub>5</sub>	0.81	0.52	0.75	0.69	0.08	
12.	MnO	5.89	5.21	6.34	5.81	0.05	

### Aggregate Crushing Value (ACV)

Table 2 shows the result of aggregate crushing value test on RISS and granite aggregate. From the table, both RISS and granite aggregate have ACV values of 9.64 and 8.58, respectively. These values are less than 10 as specified by BS EN1097 – 2: 2000. Hence, both are classified as exceptionally strong and can withstand crushing force under load. These two aggregates are durable and can be used for aggregate in concrete production. The result of this test confirms the result obtained by Omopariola and Jimoh (2018) for ACV which is within 6.2 and 9.45; the results met the requirement specified in BS EN 1097-2: 2000.

### Aggregate Impact Value (AIV)

Table 3 shows the result of aggregate impact value test on RISS and granite aggregate. From the table, the average AIV for RISS and granite aggregate are 24.33 and 20, respectively. This revealed that the aggregate can be used for heavy duty concrete flooring, concrete pavement floor and any other concrete works as specified in BS 812 – 112 (1990). Pajgade and Thakur (2013) and Subathra and Gnanavel (2014) had 23.21 and 4.3, and 25.26 and 9.03 for AIV of steel slag and granite aggregate respectively in their studies. Omopariola and Jimoh (2018) had all the AIV in their study to be less than 30 and came to the conclusion that the aggregate used for their study are suitable for concrete works relating the result of their study to the specification in BS EN1097-6: 2000.

### Sieve Analysis

The results of the sieve analysis conducted on RISS aggregates were presented in Figure 1. As shown in the figure, the coefficient of uniformity, CU were 4.00, 4.61 and 4.35 and coefficient of concavity, CC were 1.33, 1.01 and 1.00 for maximum aggregate sizes of 37.5, 20 and 12 mm respectively. These values were greater or equal to 4.00 for CU and less than 3 for CC (Michael and John, 2006) hence the RISS aggregate are well graded and the resulting concrete produced are dense and of high strength.

Also the particle size distribution for granite aggregate used to produce concrete in this study was as presented in Figure 2. From the figure, the coefficients of uniformity for granite aggregate are 4.64, 4.00 and 4.00 and coefficients of concavity are 1.76, 1.16 and 1.01 for maximum aggregate size of 37.5, 20 and 12 mm respectively. These values were greater or equal to 4.00 for CU and less than 3 for CC (Michael and John, 2006) hence the granite aggregate are well graded and the resulting concrete produced are dense and of high strength.

Particle size distribution for sharp sand was presented in Figure 3. From the figure, it can be deduced that the coefficient of uniformity for sharp sand was 13.3 which was greater than 6, hence the sand is well graded and the resulting concrete produced is dense and of adequate strength.

**Table 2: Aggregate crushing value for RISS and granite aggregate**

PARAMETER	RISS AGGREGATE									GRANITE AGGREGATE		
	RISS A			RISS B			RISS C			1 <sup>ST</sup> Trial	2 <sup>ND</sup> Trial	3 <sup>RD</sup> Trial
	1 <sup>ST</sup> Trial	2 <sup>ND</sup> Trial	3 <sup>RD</sup> Trial	1 <sup>ST</sup> Trial	2 <sup>ND</sup> Trial	3 <sup>RD</sup> Trial	1 <sup>ST</sup> Trial	2 <sup>ND</sup> Trial	3 <sup>RD</sup> Trial			
W <sub>1</sub> (Kg)	3.25	3.25	3.25	3.25	3.25	3.25	3.25	3.25	3.25	3.25	3.25	3.25
W <sub>2</sub> (Kg)	0.30	0.31	0.32	0.33	0.32	0.30	0.31	0.32	0.31	0.28	0.27	0.29
ACV	9.23	9.54	9.85	10.15	9.85	9.23	9.54	9.85	9.54	8.50	8.31	8.92
Av. ACV	9.54			9.74			9.64					
Av. ACV (A, B & C)	9.64									8.58		

Where:

W<sub>1</sub> = Total weight of aggregate

W<sub>2</sub> = Weight of aggregate passing 2.36 sieve size; ACV = Aggregate crushing value;  $Av.AC\bar{V} = \frac{W_2}{W_1} \times 100$ ; Av. ACV (A, B & C) = Average Aggregate value (A, B & C)

**Table 3: Aggregate impact value (A.I.V) for RISS and granite aggregates**

PARAMETER	RISS AGGREGATE									GRANITE		
	RISS A			RISS B			RISS C			1 <sup>st</sup> Trial	2 <sup>nd</sup> Trial	3 <sup>rd</sup> Trial
	1st Trial	2nd Trial	3rd Trial	1st Trial	2nd Trial	3st Trial	1 <sup>st</sup> Trial	2nd Trial	3rd Trial			
M1	235	232	235	234	235	236	235	234	232	234	235	233
M2	54	56	62	52	61	59	54	52	60	47	47	49
AIV	23	24	26	22	26.0	25	23	22	26	20	20	21
Av. AIV	25			24			24					
Av. AIV (A, B & C)	24.33									20		

Where:

M1 = Oven dried Sample (g)

M2 = Oven dried Sample Passing 2.36mm Sieve

$$\text{Aggregate Impact Value (AIV)} = \frac{M_2}{M_1} \times 100$$

Av. AIV (A, B & C) = Average Aggregate Impact Value (A, B & C)

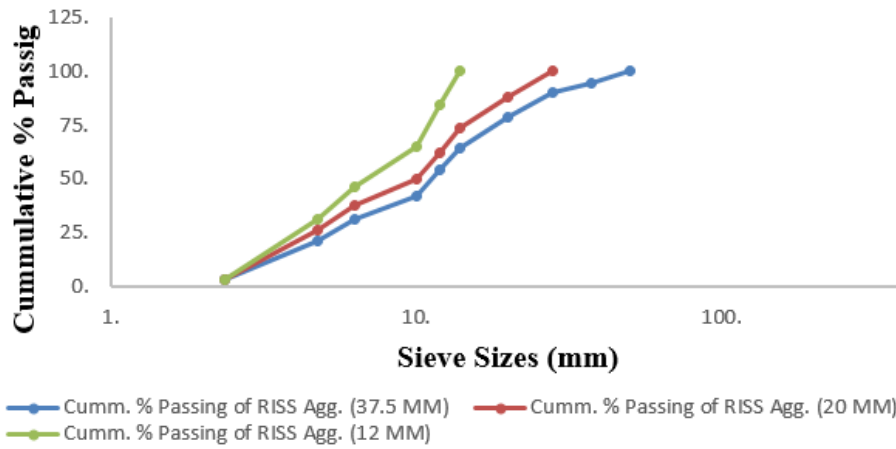

Figure 1: Particle size distribution graph of RISS aggregate for 37.5, 20.0, and 12.0 mm

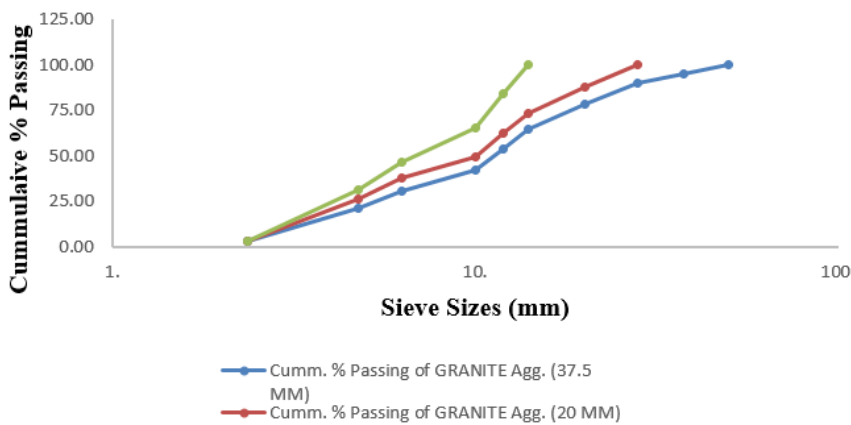

Figure 2: Particle size distribution graph of granite aggregate for 37.5, 20.0, and 12.0 mm

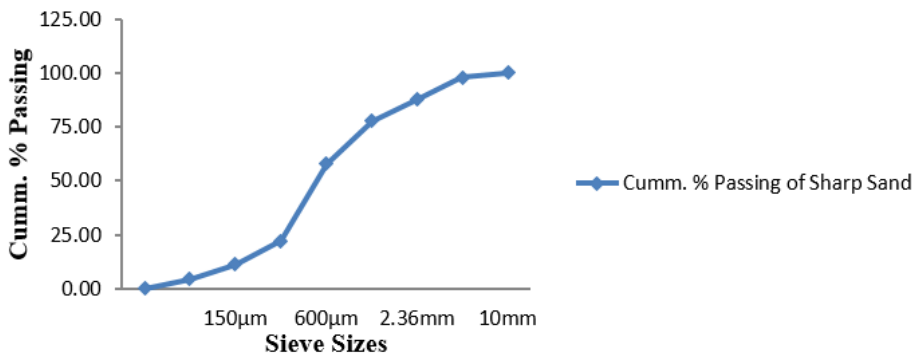

Figure 3: Particle size distribution graph for sharp sand

### Flexural Strength

#### *Effect of maximum aggregate size (MAS) on flexural strength of concrete*

Figure 4 a, b and c present the result of the Effect of MAS of 37.5, 20 and 12 mm on the flexural strength of concrete beam samples of 100 mm × 150 mm × 500



mm at 28 days of curing. From Figure 4a it was observed that the flexural strength values for 37.5, 20.0 and 12.0 mm MAS for mix ratio 1:1½:3 at 0, 10, 20, 40 and 60 % granite aggregate replacement with RISS aggregate increases by 7.76%, 8.89% and 8.97% respectively from 0 – 60% RISS replacement while from Figure 4b the values of flexural strength for mix ratio 1:2:4 at MAS of 37.5, 20 and 12 mm increases from by 7.35%, 7.43% and 9.5% respectively from 0 – 60% RISS replacement; and from Figure 4c for mix ratio 1:3:6 at MAS of 37.5, 20.0 and 12.0 mm the values of flexural strength increases by 5.47%, 5.67% and 5.75% respectively from 0 – 60% RISS. It was observed that the flexural strength increases as the maximum aggregate sizes decreases; the flexural strength values of concrete beam with MAS of 37.5 mm are less than the values obtained for MAS of 20 mm and the values of flexural strength obtained for MAS of 20 mm are less than those obtained for MAS of 12 mm. Hence, the lesser the maximum aggregate sizes the higher the flexural strength of concrete beam.

It was also observed that the flexural strength of treatment beams (beams with RISS aggregate) were higher than control beams (beams without RISS aggregate), these could be attributed to the higher percentage of Iron II oxide (FeO) and Iron III oxide (Fe<sub>2</sub>O<sub>3</sub>) which formed major composition of RISS aggregate and the rough texture of the surface of RISS aggregate could be another factor that resulted into stronger bond of the aggregate and the cement paste.

Jabbar and Habeeb (2015) and Sneka et al. (2018) concluded that the flexural strength of concrete of high strength concrete increases as the maximum aggregate size decreases. Warudkar and Nigade (2015) observed increase in flexural strength at 28 day when steel slag was used to replace granite aggregate up to 75%. Kumar and Kumar (2016) observed 6 % increment in flexural strength when 30 and 35 % of slag by weight of coarse aggregate in concrete; Adedokun et al. (2018) confirms that flexural strength increase between 20 to 60 % of steel slag inclusion. The results of this study confirm the results of all these studies that the flexural strength increases as the size of aggregate decreases.

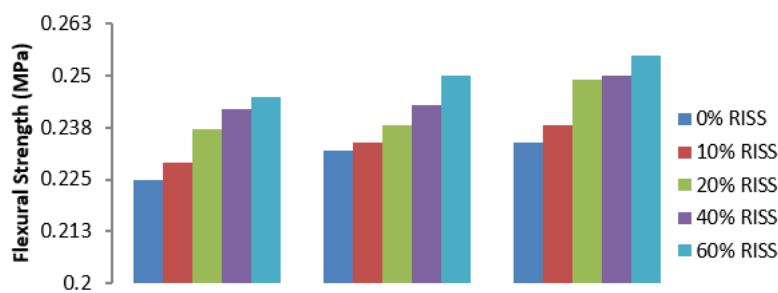

Max. Agg. Size (MAS) For Mix Ratio 1:1½:3

a. Mix Ratio 1:1½:3

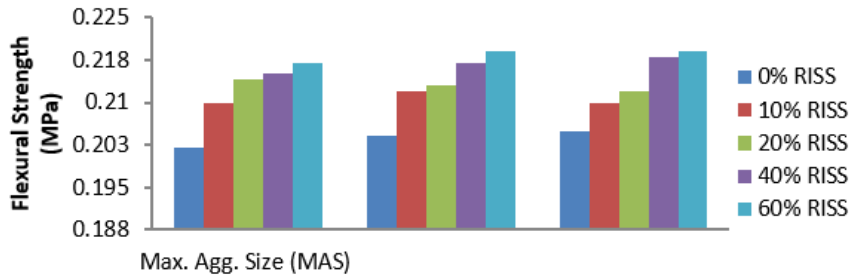

b. Mix Ratio 1:2:4

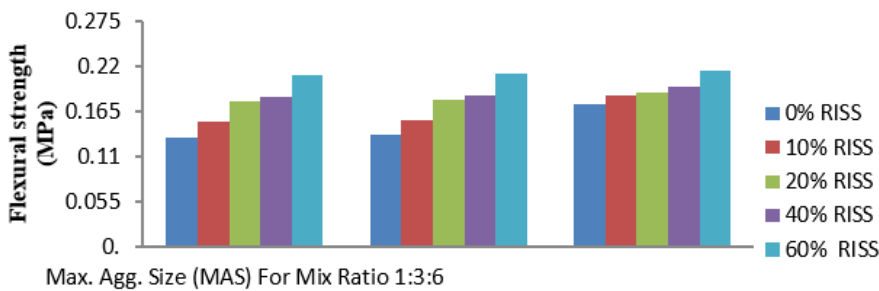

c. Mix Ratio 1:3:6

Figure 4: Effect of maximum aggregate sizes on the flexural strength of concrete

## CONCLUSIONS

From the results of tests conducted on the aggregate and concrete beams the following conclusions were drawn:

1. It was concluded that both aggregate contains silicon oxide (SiO<sub>2</sub>), calcium oxide (CaO), iron II oxide (FeO), iron III oxide (Fe<sub>2</sub>O<sub>3</sub>) and aluminium oxide (Al<sub>2</sub>O<sub>3</sub>) as the predominant oxides.
2. Both RISS and granite aggregate are strong and durable and can be used for aggregate in concrete
3. Both aggregate are well graded and the resulting concrete produced are dense and of high strength.
4. The flexural strength increases as the maximum aggregate sizes decreases
5. RISS concrete has higher flexural strength than granite concrete

## CONTRIBUTION TO KNOWLEDGE

The study had shown that RISS concrete has higher flexural strength than granite concrete; Flexural strength of concrete is favored by decrease in maximum aggregate size.

## REFERENCES

- Adedokun, S. I., Aniwofowose, M. A., & Odeyemi, S. O. (2018). Assessment of Steel Slag as Replacement for Coarse Aggregate in Concrete: A review, ACTA TECHNICA CORVINIENSIS – Bulletin of Engineering, Tome XI (2018). Fascicule 4: 138 – 145.
- Ajamu, S. O., & Ige, J. A. (2015). Effect of Coarse Aggregate Size on the Compressive Strength and Flexural Strength of Concrete Beam, International Journal of Engineering Research and Applications. 5 (1) part 4: 67-75.
- British Standard Institution European Norm (2000). Methods for determination of aggregate impact value (AIV), BS EN 1097 Part 6, British Standard Institution, London.
- British Standard Institution European Norm International Standard Organization (2011). Chemical analysis of refractory products by X ray fluorescence (XRF). Fused Cast-dead Method. BS EN ISO 12677: 2011, British Standard Institution, London.
- British Standard Institution (2000). Specification for Flexural Strength Testing Machine, pr EN 12390: Part 4: 2000, British Standard Institution, London.
- British Standard Institution European Norm (2000). Method for determination of Flexural Strength, BS EN 12390: Part 5: 2000, British Standard Institution, London.
- British Standard Institution (1990). Specification, Performance, Production and Conformity for aggregate impact value (AIV), BS 812 Part 112, British Standard Institution, London.
- British Standard Institution European Norm (1990). Methods for determination of aggregate crushing value (ACV), BS 812 Part 110, British Standard Institution, London.
- British Standard Institution European Norm (2000). Specification, Performance, Production and Conformity for aggregate crushing value (ACV), BS EN 1097 Part 2, British Standard Institution, London.
- British Standard Institution European Norm (2002). Specification, Performance, Production, usage and Conformity of artificial aggregate, BS EN 12620, British Standard Institution, London.
- Jabbar, D. N., & Habeeb, Z. D. (2015). Influence of Maximum Aggregate Size on Strength Development of High Strength Concrete and Self Compacting Concrete, Al Taquani28 (1): 95 – 113.
- JIS A 5011-1:2013. Specification for Slag Aggregates for Concrete, Part 4, Japanese Industrial Standard, Japan.
- Kumar, P. V., & Kumar, R. (2016). An Experimental Study on Partial Replacement of Coarse Aggregate by Iron Slag with Polypropylene Fiber, International Journal of Science and Research (IJSR) 5 (3): 212 – 216.
- Micheal, S. M., & John, P. Z. (2006). Materials for Civil and Construction Engineers, Pearson Education Inc. (2nd Ed.). Upper Saddle River, New Jersey.
- NIS 444 - 1 (2003). Portland Limestone Cement. Standard of Quality for Ordinary Portland Cement, Nigerian Institution of Standard, Nigeria.
- Nippon Slag Association (2015). Types and Source of Iron and Steel Slag, Retrieved on 6th July, 2016 at [www.slg.jp/association/index.html](http://www.slg.jp/association/index.html)
- Olonade, K. A., Kadiri, M. B., & Aderemi, P. O. (2015). Performance of Steel Slag as Fine Aggregate in Structural Concrete. Nigerian Journal of Technology. 34(3): 452-458.

- Omopariola, S. S., & Jimoh, A. A. (2018), A Comparative Study of the Physical and Mechanical Properties of Coarse aggregates Produced in Ogun State. *Nigerian Journal of Technology (NIJOTECH)*.37 (1): 67-70.
- Pajgade, P. S., & Thakur, N. B. (2013). Utilization of Waste Product of Steel Industry, *International Journal of Engineering Research and Applications (IJERA)*. 3, (1): 2933-3041.
- Sezer, I. G., & Gulderen, M. (2015), Usage of Steel Slag in Concrete as Fine and / or Coarse Aggregate, *Indian Journal of Engineering and Materials Sciences*. (22): 339-344.
- Sneka, S., Nirmala, M., & Dhanalakshmi, G. (2018), Size Effect of Aggregate on the Mechanical Properties of Concrete, *International Research Journal of Engineering and Technology (IRJET)*. 5 (2): 2093 – 2096.
- Subathra, D. V., & Gnanavel, B. K. (2014), Properties of Concrete Manufactured using Steel Slag, *Procedia Engineering* 97, 12th Global Congress on Manufacturing and Management (GCMM) 2014. Available online at [www.sciencedirect.com](http://www.sciencedirect.com), (<http://creativecommons.org/licenses/by-nc-nd/3.0/>), doi:10.1016/j.proeng.2014.12.229.
- Tahir, S., & Ana, M. (2011). Defining of EAF Steel Slag Application Possibilities in Asphalt Mixture Production, *Journal of Environmental Engineering and Landscape Management*, 19 (2): 148-157, doi: 10.3846/16486897.2011.580910.
- Wang, Q., Yan, P., Yang, J., & Zhang, B. (2013). Influence of Steel Slag on Mechanical Properties and Durability of Concrete, *Construction and Building Materials*, 47(1):1414-1420,<http://dx.doi.org/10.1016/j.conbuildmat.2013.06.044>.
- Warudkar, A. A., & Nigade, Y. M. (2015). Technical Assessment on Performance of Partial Replacement of Coarse Aggregate by Steel Slag in Concrete, *International Journal of Engineering Trends and Technology (IJETT)*, 30 (1): 37 – 41.
- Yongchang, G., Jionhe, X., Jianbai, Z., & Kexian, Z. (2019). Utilization of Unprocessed steel slag as fine aggregate in normal and high strength concrete, *Construction and Building Materials Journal*, 204(1): 41-49.



## EFFECTS OF SAND ON THE PROPERTIES OF CEMENT-LATERITE INTERLOCKING BLOCKS

Sampson Assiamah<sup>1</sup> and Humphrey Danso <sup>2</sup>

<sup>1</sup>*Department of Building Technology, Sunyani Technical University, Sunyani, Ghana.*

<sup>2</sup>*Department of Construction and Wood Technology, Akonte Appiah-Menka University of Skill Training & Entrepreneurial Development, Ghana.*

In recent years, the attention of researchers is shifting towards the optimization of building materials by using local contents, indigenous materials, and local industrial by-products that are abundant in certain localities. This study investigates the effect of sand on the properties of cement-laterite interlocking blocks. Cement-laterite interlocking blocks were prepared with lateritic soil which was replaced with conventional fine aggregate (sand) from 5 to 25% by weight. Cement-laterite interlocking blocks without sand (0%) served as control. The blocks produced were tested to determine their density, compressive strength, and tensile strength. The average density of cement-laterite interlocking blocks increased as the percentage of sand content in the blocks decreases. The highest compressive strength (9.1 MPa) at 28-day curing of the cement-laterite interlocking blocks was obtained at 5% sand replacement, which is about 13% increase in strength over the control blocks. It was further revealed in the stress-strain relationship result that the 5% sand replacement of laterite achieved the highest stress while the 15% replacement achieved the highest strain of the cement-laterite interlocking blocks. The highest tensile strength (0.707 MPa) at 28-day curing of the cement-laterite interlocking blocks was also obtained at 5% sand replacement, which is about 9% increase strength over the control blocks. The study concludes that the sand replacement laterite in cement-laterite interlocking blocks have the potential of supporting the sustainable housing concept, and therefore recommends to manufacturers 5% sand replacement of laterite in producing cement-laterite interlocking blocks.

Key words: compressive strength, interlocking blocks, laterite, tensile strength

### INTRODUCTION

Cement-Laterite Interlocking Block (CLIB) masonry has the propensity to provide sustainable construction around the world (Adedeji, 2008; Harris, et al., 1992; Amado, et al., 2007; Chwieduk, 2003); (Calkins, 2009). Comprised of inexpensive materials, such as laterite, the interlocking blocks can be used to provide housing and other facilities at low cost (Ferguson, 2008; Raheem, A. A. ; Bello, O. A.; Makinde, O. A., 2010). By creating interlocking joints between layers of blocks,

---

<sup>1</sup> sampsonassiamah3@gmail.com

<sup>2</sup> hdanso@aamusted.edu.gh

Interlocking Compressed Earth Blocks (ICEBs) allow for the blocks to be dry-stacked, without the need for mortar (Adedeji, 2012).

In the developing world, especially in metropolitan African cities, scarcity of living accommodation has always been an issue. According to Adebakin et al. (2012), the available housing stock is diminishing by the day due to the high level of rural drift to urban centers. The scarcity and high cost of building materials and the need to drastically reduce critical housing shortages, especially in the urban areas, and developing modern housing setups in the rural areas have encouraged the search for alternative, innovative, and cost-effective building materials. One of such local materials that are being researched is lateritic soil.

According to Akintorinwa et al. (2012), lateritic soil abounds locally and its use is mainly limited to civil engineering works like road construction and landfill operations. It is less utilized in the building industry except in filling works. Irrespective of the abundance of lateritic soils and their availability, their optimum use in building production could positively affect the cost of buildings leading to the production of more affordable housing units (Joshua & Lawal, 2011). Their use in building products is not yet generally accepted because there is no sufficient technical data on it, hence limiting its wider application in building construction work (Danso, 2015; Udoeyo et al., 2006). Laterite is described as a product of in-situ weathering in igneous, sedimentary, and metamorphic rocks commonly found under unsaturated conditions (Rahardjo et al., 2004). Laterite stabilization using a mechanical approach involves the blending of different grades of soils to obtain the desired standard. These properties can however be improved through stabilization to improve the characteristics and strength (Danso, 2017a). Amu et al. (2011) described soil stabilization as any treatment applied to a soil to improve its strength.

Recently there has been a worldwide resurgence of interest in earth building, especially in developing countries where local earth is the most accessible source of building material. However, most soils do not contain the mix of clay, silt, and sand required for good earth building (Roux & Alexander, 2007). The attention of researchers is shifting towards the optimization of building materials by using local contents, indigenous materials, and local industrial by-products unique and abundant in certain localities. This study, therefore, explored ways in which sand could be utilized in cement–laterite interlocking block production. One of the early works on laterite was by Udeoyo et al (2006) who studied the Strength performance laterite concrete. They found that partial replacement of lateritic soil for concrete was good.

Joshua et al. (2011) studied the cost of sandcrete blocks through partial replacement of sand with lateritic soil. They found that partial replacement of sand with lateritic soil blocks was cheaper. Osunade (2002) studied the effect of replacement of lateritic soils with granite fines on the compressive and tensile strengths of laterized concrete. He also found that the strength for compressive and tensile were good.

Raheem et al. (2010) investigated a comparative study of cement and lime stabilized lateritic interlocking blocks. They established that for lateritic soils to be economical in the industry, the range of particle sizes used in moulding blocks

must tend towards the silt fraction. This study, therefore, fills this gap by investigating the effect of sand on the properties of cement- laterite interlocking blocks. In order to achieve this, cement-laterite interlocking blocks were prepared with lateritic soil which was replaced with 5, 10, 15, 20 and 25% sand by weight and the blocks were tested to determine their density, compressive strength, and tensile strength.

## MATERIALS AND METHODS

### Materials

#### *Sand*

The sand was obtained from Chiraa in Sunyani, and met the requirement specified by British Standard Institution (BS EN 12620:2002+A1:2008). After procurement, the sand was air dried to constant weight in the Building Department Workshop at Sunyani Technical University.

#### *Cement*

The cement used is ordinary Portland cement manufactured by Dangote Cement Company. The Cement with grade 42.5R is a fine mineral powder manufactured with very precise processes.

#### *Laterite*

Laterite used for preparing the interlocking blocks was obtained from Koutokrom in Sunyani. The large lumps were crushed and sieved through ASTM sieve No.8 (aperture 2.36mm). The lateritic samples were reddish in colour as shown in Figure 1. The general properties of the laterite were determined by laboratory tests. These tests were conducted in accordance with British Standard specifications (BS1377-9:1990). Wet sieving and sedimentation were carried out to determine the grain-size distribution of the laterite with different sizes of sieves.



Figure 1: Laterite used for moulding interlocking blocks.

#### *Water*

The water used for this study was clean and did not contain any dangerous organic or chemical content. It was obtained from free flowing tap, supplied by Ghana Water Company limited.

### Production of cement-laterite interlocking blocks

A mix proportion of 1:6 of cement: laterite by weight (Figure 2) was used in the work. The sand replacement of proportion 0, 5, 10, 15, 20 and 25% to the weight of laterite was used. The mixing was done by the use of shovel to provide a very plastic paste. The laterite samples were mixed with cement and water-cement ratio of 0.7 was used as control sample. For the experimental blocks, the laterite, cement and sand replacement percentage ranging from 5 to 25% were mixed to desired

consistency. The mixture was then loaded into the block mould for the interlocking blocks of size 220 x 185 x 120 mm, and hydraulically moulded at a constant pressure of 10 MPa as shown in Figure 3, and then cured for up to 28 days.



Figure 2: Batching of the materials.



Figure 3. Hydraform interlocking blocks machine with single mould and blocks

Thirty-six (36) blocks each at varied percentage (5, 10, 15, 20 and 25%) of sand replacement of the laterite were produced, cured, and tested on 7, 14, 21 and 28 days for density, compressive strength and tensile strength. For control, Thirty-six (36) interlocking blocks were moulded, thus 100% laterite, which can be seen in Table 1. The total number of blocks produced for the test was two hundred and sixteen (216).

**Table 1: Types of Test and Number of the interlocking blocks moulded**

Test	Sand (%)	Curing days				Total
		7	14	21	28	
Compressive	0	3	3	3	3	12
	5	3	3	3	3	12
	10	3	3	3	3	12
	15	3	3	3	3	12
	20	3	3	3	3	12
	25	3	3	3	3	12
Tensile	0	3	3	3	3	12
	5	3	3	3	3	12
	10	3	3	3	3	12
	15	3	3	3	3	12
	20	3	3	3	3	12
	25	3	3	3	3	12
Density	0	3	3	3	3	12
	5	3	3	3	3	12
	10	3	3	3	3	12
	15	3	3	3	3	12
	20	3	3	3	3	12
	25	3	3	3	3	12
Total		54	54	54	54	216



### **Curing of lateritic interlocking blocks**

The blocks were first allowed to air dry under a shade made with polythene sheet for 24 hours. Thereafter, curing started by sprinkling water on the blocks in the morning and evening each day, and covered with polythene sheet to prevent



rapid drying as shown in Figure 4.

Figure 4: Curing of the specimen with water and polythene sheets.

### **Testing of blocks**

The experimental tests carried out are density, compressive strength and tensile strength. Details of the tests are explained below.

#### ***Density***

The density of the blocks was determined as per BS EN 771-1:2011+A1:2015. Three blocks from each mix were selected and oven dried at a temperature of 105°C after each curing age until a constant mass was recorded, indicating a normal dried block. The dried blocks were weighed (Figure 5), their dimensions measured and the density calculated.



Figure 5: Measuring the weight of the block

#### ***Compressive strength***

Compressive strength was performed in accordance with BS EN 12390-6 (2009) and was carried out with a Universal Testing Machine (Model: 50\_C34A2, serial no: 0294910). The blocks were tested at the curing ages of 7, 14, 21 and 28 days. A 25mm thick rectangular timber platen having the same shape of the interlocking blocks were placed on top and bottom of the block and placed in the test machine as shown in Figure 6. The blocks were then crushed and the matching failure load recorded. The crushing force was divided by the cross sectional area of the block to determine at the compressive strength. Stress-strain values were obtained from

the compressive strength test and were used to explain the stress-strain relationship of the blocks.



Figure 6: Compressive Strength test set up

### ***Tensile strength***

The splitting tensile strength test was performed in accordance with BS EN 12390-6 (2009). This was carried out with the testing machine (CONTROLS 50-C46G2), and splitting jigs were positioned centrally above and below the block as shown in Figure 7. The loading was applied constantly at a study rate of 0.05 N/mm<sup>2</sup>/s until the split of each block. The maximum load applied at which each of the blocks failed were recorded and splitting tensile strength calculated.



Figure 7: Tensile Strength Test

## **RESULTS AND DISCUSSION**

### **Density of sand-cement-laterite interlocking blocks**

The average density of the sand-cement-laterite interlocking blocks at various days of curing is shown in Table 2.

**Table 2: Density of sand-cement-laterite interlocking blocks**

Curing Day	Density of blocks (kg/m <sup>3</sup> )					
	0%	5%	10%	15%	20%	25%
7	1937	1853	1863	1873	1941	1932
14	1864	1843	1852	1859	1893	1862
21	1795	1780	1785	1788	1799	1790
28	1784	1757	1774	1780	1790	1782

Table 2 shows the summary of the average density of cement-laterite interlocking blocks. It can be seen that as the curing days increase, the density decreases with each percentage of sand replacement. This means that as the curing days were increasing the blocks were also losing their moisture contents gradually in order to gain their strength, so as the days are increasing the blocks also lose their weight at the drying stage (Danso, 2017b). In these results, the minimum density in day 7 was 1853kg/m<sup>3</sup> (5% sand) whereas the maximum density recorded 1941 kg/m<sup>3</sup> (20% sand), the minimum density in day 14 was 1843kg/m<sup>3</sup> (5% sand) whereas the maximum density recorded 1893 kg/m<sup>3</sup> (20% sand), the minimum density in day 21 was 1780kg/m<sup>3</sup> (5% sand) whereas the maximum density recorded 1799 kg/m<sup>3</sup> (20% sand), the minimum density in day 28 was 1757kg/m<sup>3</sup> (5% sand) whereas the maximum density recorded 1790 kg/m<sup>3</sup>(20% sand).

### Compressive strength of sand-cement-laterite interlocking blocks

The results of the compressive strength tests of the sand-cement-laterite interlocking blocks are shown in Figure 7.

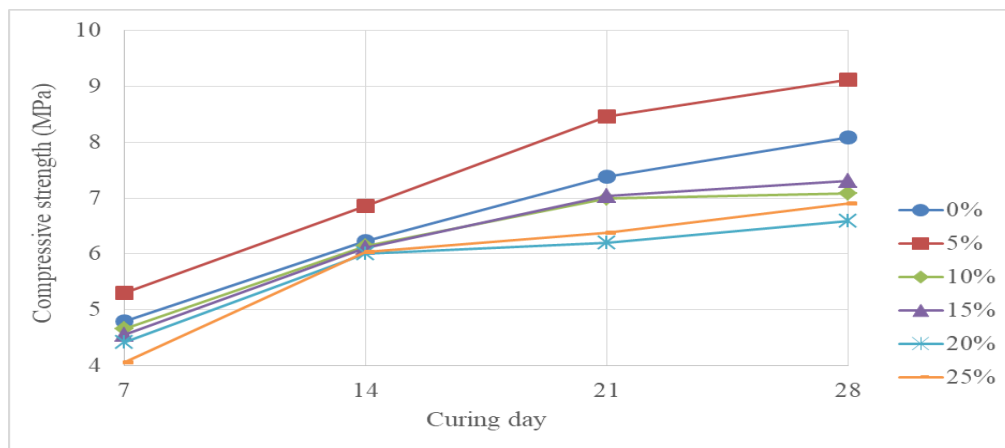

Figure 7: Compressive strength tests results

The effect of curing ages on the compressive strength of sand replacement of laterite presented in Figure 4.1 indicates that all the percentage of sand replacements show continuous increase with increased curing age. However, only 5% sand replacement yielded higher strength above the control specimen (0%) and the rest were all below the control specimen. This is because the sand content in the laterite were more and does not need any sand replacement exceeding 5%. The results show that blocks slowly gained strength at early curing age. This is in line with previous findings that blocks containing sand content at high quantities gained strength slowly at early curing ages (Hossain, 2005; Adesanya & Raheem, 2009a). At 28 days, there was continuous increase in compressive strength for all the percentages of blocks with values ranging from 8.089 MPa for the control to 6.197 MPa for 20% sand replacement. The highest compressive strength (9.1 MPa) at 28-day curing of the cement-laterite interlocking blocks was obtained at 5% sand replacement, which is about 13% increase in strength over the control blocks.

### Stress-strain relationship of the blocks

Figure 8 shows the stress-strain relationship of the cement-laterite interlocking blocks after 28-day curing.

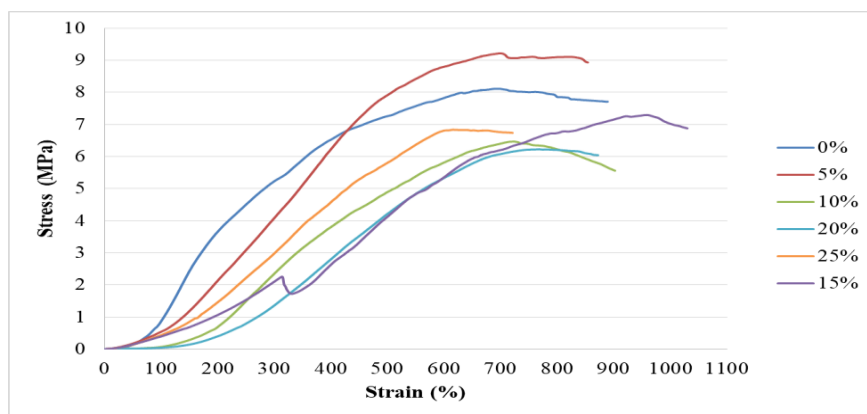

Figure 8: Stress-strain relationship of the blocks at 28-day curing

It can be seen from the stress-strain curves shown in Figure 8 that 5% sand replacement yielded the highest stress above the control level of 0% and the rest of the percentages of sand replacement were below the control. This is due to the fact that there was enough sand content in the laterite so in this case it was only sand content from 0% to 5% which were needed for optimum strength. Similar findings are also shown in a previous study (Fatemeh et al., 2012). The 10% and 15% sand replacement were subjected to higher deformation above the control and the rest of the percentages of sand replacements are below.

### Tensile strength of sand-cement-laterite interlocking blocks

The results of the tensile strength tests on sand-cement-laterite interlocking blocks are shown in Figure 9.

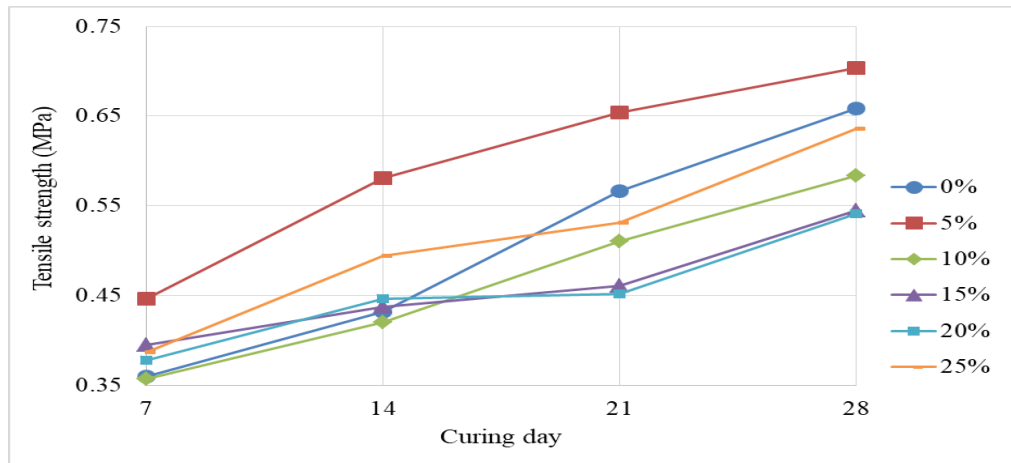

Figure 9: Effect of Sand content on Tensile Strength Test Results

The results indicate that all the percentage of sand replacements show continuous increase with increased curing age. The highest tensile strength (0.707 MPa) at 28-day curing of the cement-laterite interlocking blocks was obtained at 5% sand replacement, which is about 9% increase strength over the control blocks. However, it is observed that the tensile strength of all the sand replacements from 10% to 25% were below the control specimen, which could be due to the fact that the sand content in lateritic soil were high and does not need additional sand content exceeding 5% which will result in the blocks specimen creating more pores. Studies by Bahar et al. (2004) and Morel (2001) and Medjo Eko et al. (2012) with cement as stabilizer in soil blocks recorded similar trend.

## CONCLUSIONS

The following conclusions are drawn from the results:

- It was observed that the densities for cement-laterite interlocking blocks produced with sand replacement at 20% were the highest.
- The results indicated that the highest compressive strength of 9.1 MPa at 28-day curing was obtained at 5% sand replacement of the cement-laterite interlocking blocks, which resulted in about 13% increase in compressive strength over the control blocks.
- Again, it was observed that the highest tensile strength of 0.707 MPa at 28-day curing of the cement-laterite interlocking blocks was achieved at 5% sand replacement, which was about 9% increased strength over the control blocks.
- On the basis of the above, it can be concluded that the sand replacement of laterite in cement-laterite interlocking blocks has the potential of being used as building units for sustainable application. The study recommends 5% sand replacement of laterite for cement-laterite interlocking blocks for construction block producers. Lastly, further investigation on the use of cement laterite interlocking blocks should be made with emphasis on the effect of addition of natural fibres on the strength of the blocks.

## REFERENCES

- Adebakin, I. H., Adeyemi, A. A., Adu, J. T., Ajayi, F. A., Lawal, A. A., & Ogunrinola, O. B. (2012). Uses of sawdust as admixture in production of low-cost and light-weight hollow sandcrete blocks. *American Journal of Scientific and Industrial Research*, 3(6): 458-463.
- Adedeji, Y. M. (2008). Interlocking masonry: Panacea for sustainable low-cost housing in Nigeria. *Pakistan Journal of Social Sciences*, 5(8), 744-750.
- Adedeji, Y. M. (2012). Sustainable housing provision: preference for the use of interlocking masonry in housing delivery in Nigeria. *Architecture Research*, 2(5), 81-86. doi:10.5923/j.arch.20120205.03
- Akintorinwa, O. J., Ojo, J. S., & Olorunfemi, M. O. (2012). Geoelectric Reserve Highway, South-west Nigeria. *Journal of Emerging Trends in Engineering and Applied Sciences (JETEAS)* 3(3): 490-496.
- Bahar, R., Benazzoug, M., & Kenai, S. (2004). Performance of compacted cement-stabilised soil. *Cement & Concrete Composites*, 26, 811-820.
- British Standard EN 12620: (2002). +A1: (2008). Aggregates for concrete masonry units.
- British Standard Institution (1992). Specification for aggregates from natural sources of concrete, BS 882: 1992.
- British Standard EN 771-1: (2011) +A1 (2015). Specification for masonry units.
- BS 1377-9: (1990). Method of test for soils for civil engineering. The British Standard Caldeira, E. (1999). Learn Construction, <http://www.housingzone.com/info/CA379761.html>, 10/03/07, 8pm GMT

- Calkins, M. (2009). *Materials for sustainable sites: a complete guide to the evaluation, selection and use of sustainable construction materials*. Hoboken, NJ, USA: John Wiley & Sons.
- Danso, H. (2017a). Experimental Investigation on the Properties of Compressed Earth Blocks Stabilised with a Liquid Chemical. *Advances in Materials*, 6(6), 122–128, doi: 10.11648/j.am.20170606.13,
- Danso, H. (2017b). Improving Water Resistance of Compressed Earth Blocks Enhanced with Different Natural Fibres. *The Open Construction and Building Technology Journal*, 11, 433-440. DOI: 10.2174/1874836801711010433
- Danso, H. (2015). Use of agricultural waste fibres as enhancement of soil blocks for low-cost housing in Ghana. PhD Thesis, School of Civil Engineering and Surveying, University of Portsmouth, [https://researchportal.port.ac.uk/portal/files/5549269/Thesis\\_Humphrey\\_Danso\\_676877\\_.pdf](https://researchportal.port.ac.uk/portal/files/5549269/Thesis_Humphrey_Danso_676877_.pdf)
- Fatemeh, S. R., Saifullah, R., Abbas, F. M. A., & Azhar, M. E. (2012). Total phenolics, flavonoids and antioxidant activity of banana pulp and peel flours: influence of variety and stage of ripeness *Int. Food Res. J.*, 19 (3): 1041-1046.
- Hossain, K. M. A. (2005). Blended cement using volcanic ash and pumice. *Cement and Concrete Research*, 33(10), 1601–1605. doi:10.1016/s0008-8846(03)00127-3.
- Joshua, O., & Lawal, P. O. (2011). Cost Optimisation of Sandcrete Blocks through Partial Replacement of Sand with Lateritic Soil. *Epistemics In Science Engineering And Technology*, 1(2), 89-94.
- Lasisi, F., & Osunade, J. A. (1984). Effects of grain size on the strength of cubes made lateritic soils. *Building and Environment*; 19:55-8.
- Medjo Eko, R., Offa, E. D., Ngatcha, T. Y., & Minsili, L. S. (2012). Potential of salvaged steel fibers for reinforcement of unfired earth blocks. *Construction and Building Materials*, 35, 340-346, doi.org/310.1016/j.conbuildmat.2011.1011.1050.
- Morel, J. C., Mesbah, A. Oggero, M., & Walker, P. (2001). Building houses with local materials: means to drastically reduce the environmental impact of construction. *Build. Environ.*, 36, 1119-1126.
- Raheem, A.A.; Bello, O. A., & Makinde, O. A. (2010a). A Comparative Study of Cement and Lime Stabilized Lateritic Interlocking Blocks. *Pacific Journal of Science and Technology*. 11(2):27-34.
- Osunade, J. A. (2002). Effect of replacement of lateritic soils with granite fines on the compressive and tensile strengths of laterized concrete. *Building and environment*, 37, 491-496.
- Raheem, A. A., & Adesanya, D. A. (2009). A study of the workability and compressive strength characteristics of corn cob ash blended cement concrete.
- Rahardjo, H., Aung, K. K., Leong, E. C., & Rezam, R. B. (2004). Characteristics of Residual Soils in Singapore as Formed by Weathering. *Journal of Engineering Geology*, 73:157-169
- Udoeyo, F. F., Udeme, H. I., & Obasi, O. O. (2006). Strength performance laterized concrete, *Journal of Construction and Building Materials*, Elsevier, 20(10), 1057-1062.



# ENABLERS OF MUTUAL SATISFACTION IN TRANSNATIONAL PUBLIC INFRASTRUCTURE DEVELOPMENT: THE CASE OF SINO-GHANA

Bridget Tawiah Badu Eshun<sup>1</sup>, Albert P. C. Chan<sup>2</sup> and Frank D.K. Fugar<sup>3</sup>

<sup>1,2</sup>*Dept. of Building and Real Estate, Hong Kong Polytechnic University, Hung Hom, Kowloon, Hong Kong*

<sup>3</sup>*Dept. of Construction Technology and Management, Kwame Nkrumah University of Science and Technology, Kumasi, Ghana*

Sino-Ghana relations have steadily grown over the years and have influenced the increase in various economic sectors especially infrastructure development in Ghana. The unique nature of Chinese corporations heavily engaged in Ghana's infrastructure development has captured research attention. Although several studies have been done on Sino-Ghana trade and infrastructure relations, little attention has been placed on the achievement of mutual satisfaction (MS) for both parties. It is crucial to empirically investigate MS in these partnerships since both parties having distinct interests, collectively work towards the provision of public infrastructure. This study adopted a three-staged approach of identification, assessment, and modelling of factors that enable the achievement of MS in transnational infrastructure partnerships. This involved an extensive review of literature and elicitation of views from purposively sampled private and public experts. The Interpretive Structural Modelling (ISM) approach was adopted in modelling the enablers which generated a systemic structure highlighting their relationships. Results indicated that enablers of achieving MS in these partnerships are interrelated and collectively act to create an environment of achieving mutual satisfaction. The enablers of MS include fair risk-bearing, equal and active participation of project parties, flexible contracting, strategic negotiation, efficient private and public sector capabilities, equitable distribution of project benefits, existence of mutual trust, and commitment. This paper provides an objective approach towards the quest for achieving mutual satisfaction and summarizes enablers that can be used in pushing the attainment of MS in China-Ghana infrastructure relations. Findings can be used as a basis for policy development uniquely for these partnerships to also improve the achievement of value for money and overall project success in China-Ghana infrastructure relations.

Keywords: Interpretive Structural Modelling (ISM), Mutual Satisfaction (MS), public infrastructure, Sino-Ghana, transnational

---

<sup>1</sup> beshun44@gmail.com

<sup>2</sup> albert.chan@polyu.edu.hk

<sup>3</sup> frankfugar@yahoo.com



## INTRODUCTION

Infrastructure is a key measure of the development of any country as it creates an enabling environment for investments and livelihood which promotes economic growth and development (Ajakaiye and Ncube, 2010). This has steered the desire of most country leaders in Africa to strive for infrastructure development. Despite the evident efforts of these leaders, infrastructure development in Africa remains a challenge due to insufficient financial and technical resources. (Mitullah et al.,2016). Embracing foreign direct investments (FDIs) has become the go-to for most African countries towards bridging their infrastructure gap. In the vein of FDIs, studies show an enormous boom in Sino-Africa relations making China the highest donor and investor to African countries in recent times (Habiyaemye and Oğuzlu, 2014; Yu et al.,2019; Wang et. al., 2020).

Relations between China and Africa besides trading have seen a major impact in the aspect of infrastructure provision. China has steadily combined the extension and provision of financial aid for the construction of infrastructure in Africa (Alves, 2013). The Chinese belt and road initiative (BRI) in Africa has been influential in reducing Africa's infrastructure deficit with the provision of roads, ports, railways, energy, etc. (Ndzendze and Monyae, 2019). China's infrastructure engagement in Africa mostly comes as financial or technical aid or both through state-owned firms (Ubi, 2014) therefore projecting a unique transnational private sector initiative in Africa's infrastructure procurement.

African countries must maximize the Sino-Africa engagements to improve their infrastructure by tapping more into the moving trend of transnational public-private partnerships (TPPPs) (Cheng, 2019). TPPPs can briefly be defined as formalized international agreements between a private sector and public sector to deliver collective goods. In TPPPs the non-state actors (private sector) co-govern alongside the state actors (public sector) in the provision of the collective goods which is usually the sole mandate of the state actors (Schäferhoff et al.2009). This describes most Sino-African infrastructure engagements as China through their state-owned enterprises' partner with African governments in the provision of public infrastructure.

Despite, the undeniable evidence of China's aid in Africa's infrastructure, there lies some segmentation in literature on the prime motive of these investments. Some capture the intent of engaging in partnerships that are mutually beneficial and to promote and strengthen cooperation ties while others report that, it is some form of debt trap and interest in raw materials (Addis et al.,2020). Thus, Chinese investments in Africa often targeted to resource-rich countries need to be investigated uniquely. Addis et al., (2020) further stated that the sustainability and whether these partnerships and mechanisms culminate mutually satisfactory deals remains unseen. The realization of maximum benefit to both parties in these dealings requires a deliberate and concerted effort from both actors (Ndzendze and Monyae, 2019).

Given the unique nature of Sino-Africa infrastructure relations amid possible varying perceptions on the motives and overall achievement of mutual satisfaction or win-win for both parties, this study seeks to identify and assess factors that



enable and create the environment for the achievement of mutual satisfaction in these TPPPs. Eshun et al. (2020) conceptualized the achievement of mutual satisfaction or win-win as a system of interacting factors. Therefore, the identified enabling factors are assessed and modelled into a systemic structure (interactive system) using interpretive structural modelling (ISM) depicting how these enablers interact in attaining mutual satisfaction. The case of Ghana is considered in this regard as engagements of China in Ghana have also seen a significant boost.

## **LITERATURE REVIEW**

### **Transnational Public-Private partnerships (TPPPs)**

Despite the immense growth of TPPPs in most policy domains such as social rights and security, environmental politics, and development cooperation, views are divided pertaining to its emergence and description (Schäferhoff et al.2009). TPPPs are “institutionalized transboundary interactions between public and private actors, which aim at the provision of collective goods” (Schäferhoff et al.2009). These models generally move from a more publicly involved towards a more privately involved or owned engagements and are described based on three criteria i.e. actors, goals, and the sharing of risks and responsibilities. According to Park and Jun (2016), the definition of TPPPs is not clear-cut, as the scope can be very diverse hence this paper deduces a definition appropriate for analytical research. The realist perspective is adopted in this study describes Transnational PPPs as the resultant of the overlap between public and private actors ‘interests which is an initiative-based approach towards solving a problem (provision of public infrastructure) by the collective action of these private and public actors (Park and Jun, 2016).

### **Mutual satisfaction in TPPPs**

Studies have shown that public and private actors have varying interests in the delivery of public infrastructure. This has sprung up some shortcomings in the implementation of the project and therefore requires deliberate efforts to attain mutual satisfaction or win-win throughout the project life (Eshun et al., 2020). According to Grimshaw et al., (2002) evidence of the achievement of mutual satisfaction is little in these partnerships due to elements of power imbalance and inequitable distribution of project gains. Furthermore, these partnerships due to the dire need for funding and technical aid on the part of the public actors create room for a leader-follower relationship where, responsibilities, management, and deals are unfair (Shi et al.,2016). Differences in the prime interests of public and private actors are dynamic and therefore the need to continuously thrive for mutual satisfaction through strategic partnership activities (Kobylinska, 2017). This study describes mutual satisfaction as a conscious and continuous effort of project actors to ensure the prime interests of all parties are reasonably achieved. Additionally, following the description by Eshun et al., (2020) this study also considers the achievement of MS as a system of interacting factors where strategies should operate simultaneously for achieving MS.

### **Sino-Africa infrastructure relations**

The rate at which China is engaging and investing in Africa is grabbing attention and such investments have experienced a huge leap in recent years (Ubi, 2014). In 2009, records indicated that China surpassed the world bank (the then top lender)

as Africa's lender and became the largest trading partner to the continent (Akyeampong and Fofack, 2019). China has made several infrastructure investments in Sub-Saharan Africa (Zhang et al., 2014). The nature of Chinese investments differs from that of other western countries due to their dominance of state-owned enterprises and the provision of readily available financial and technical aid hence cannot be treated like any other type of foreign direct investment (Auffray and Fu, 2015). To mention a few, China was involved in the Ethiopia-Djibouti Railway Project, the railway and pipeline predicted to link the ports in Kenya to oil fields in South Sudan and Uganda, expansion of the Suez Canal in Egypt, the Kano-Lagos railway line in Nigeria amongst others.

### ***Sino-Ghana infrastructure relations***

Dating back to 1960, Ghana and China established diplomatic relations which were aimed towards the development and strengthening of bilateral ties between the two countries. The relations between China and Ghana have grown over the years and Ghana has always been well poised to benefit from Chinese interest in funding infrastructure projects overseas (Gocking, 2020). Undoubtedly, China to some extent has propelled Ghana's economic and social growth as well as brought some more tangible benefits to the country. Ghana's infrastructure has seen commendable improvement since the involvement of the Chinese state-owned firms in sectors such as roads, energy, ports, among others. The Shanghai Construction Group played a significant role in the procurement of the national theatre in Accra which was built in 1992 (Odoom, 2017). The energy and water sectors in Ghana have also experienced support from China like the construction of the Bui Hydro-electric Dam and the Sunon Asogli Power Plant through dealings with the Shenzhen energy group and China-Africa development fund. In recent times, national initiatives like the One District One Factory (1D1F), Planting for Food and Jobs and the Year of Roads Policy have benefited from Chinese corporations which provided the needed infrastructure such as roads, interchanges, warehouses, and offices.

Studies on the dealings between China and Ghana have also recorded a two-sided perspective being positive or negative to either party (Odoom 2017; Gocking, 2020). Mutually satisfactory deals for both actors are desired and fueled however the lack of managerial knowledge cripples its full glare. Most often the tendency of a win-lose outcome in such partnerships goes in favor of China (Bbaabla, 2015). A recent report on an interview with H.E. Lu. Kun the Chinese Ambassador to Ghana indicated that China is willing to take new measures to ensure the growth of friendship ties with Ghana. He however stressed the need to carry out collective dialogue and incorporation of effective mechanisms for more practical cooperation.

## **METHODOLOGY**

The approach to this study was three-phased.

**Stage I-Comprehensive literature review:** The study commenced with a comprehensive literature review. This was aimed at identifying constructs or factors captured in previous studies about obtaining mutual satisfaction or generating a win-win situation for both public and private parties. This involved an extensive

probing of literature from online research libraries such as Web of science, Scopus and google scholar. The search was focused on studies relating to construction or infrastructure procurement, delivery, or development. The review yielded several constructs which are summarized and presented in table 4.2.

**Stage II- Semi-structured expert interview:** The results from the review formed the basis of this stage. The constructs identified were developed into the research instrument used for the semi-structured expert interview. Studies with conceptual and practical implications require the use of experts. The reliance on expert opinion remains dominant in most studies as they often serve as a basis for further empirical studies (Bhandari and Hallowell, 2021). This was aimed at refining and scoping the identified constructs into practical context unique to the nature of Sino-Ghana infrastructure provision. Experts engaged were academic and industry practitioners affiliated to either the private sector (China) or the public sector (Ghana). This study purposively contacted professionals who have been engaged (practice or research) in the delivery of public infrastructure projects which involve Chinese contractors and/or funding. Another relevant requirement was to engage professionals who have expertise in TPPPs and other infrastructure procurement routes hence they could effectively relay their current experiences and proficiency suitable to the purpose of the study. This led to the identification of 13 enabling factors of MS in transnational infrastructure provision also summarized in table 4.2.

**Stage III- Development of the Interpretive Structural Model (ISM):** The ISM method was developed to create a systematic problem-solving approach to complex issues (Sohani and Sohani, 2012). Results from the initial stages depict that the constructs identified collectively enable the attainment of mutual satisfaction hence establishing their relationships is key. Moreover, ISM can be pedigreed to Structural Modelling (SM) which is a method that uses words and visuals in thoroughly defined patterns to portray a structure, complex issue or system (Poduval and Pramod, 2015). The modelling approach in ISM produces a hierarchical structure and connectivities amongst the elements based on the pairwise relationship of the elements from the judgment of a group of experts. According to Eshun et al., (2020) in the delivery of infrastructure through TPPPs, the quest for achieving mutual satisfaction can be realized if enablers are integrated and addressed as a system considering their significant relationships. Hence making the ISM an ideal analytical approach for this study.

The representative factors summarized in Table 4.2 were structured into an ISM survey instrument and presented to a purposively sampled group of respondents. Official invitations were sent out to 23 experts out of which 15 participated. Studies have shown that the number of experts engaged in ISM does not have to be huge (Shen et al.,2016; Xu et al., 2020). They could even be as low as two (Ravi and Shankar (2005) if the appropriate experts are engaged. In cases of non-convergence in relationship determination by the experts, the majority rule was applied as per other similar studies (Shen et al.,2016; Saka et al.,2020) making the odd number participation ideal in this case.

The ISM steps are described as follows:

- Step1: Identification of the variables affecting the system i.e. enablers of MS in this study.

- Step 2: Establishment of the conceptual relationship between the variables identified in the initial step.
- Step 3: Development of the Structural Self-Iteration Matrix (SSIM) with the enablers of MS. This illustrates the pairwise relationships among the variables.
- Step 4: Development of the Reachability Matrix from the SSIM and transitivity check.
- Step 5: Level partitioning based on the Reachability Matrix. This includes determining the reachability, antecedent and intersection sets.
- Step 6: Development of a model based on the relationships denoted in the reachability matrix and hierarchical structure projected.
- Step 7: The ISM model is checked for conceptual inconsistency.

## ANALYSIS AND DISCUSSION

### Expert profiling

As captured earlier the adoption of ISM approach requires expert opinion in creating problem solving and systemic conceptualization of an issue based on pairwise relationships. A total of 15 experts were involved in this study. The distribution of these experts is presented in Table 4.1

**Table 4.1 Expert profiling**

Demographics	Category	Number	Percentage
Profession	Researcher	4	26.67
	Engineer	3	20.00
	Quantity surveyor	2	13.33
	Project manager	4	26.67
	Contractor	2	13.33
	Central Government	5	33.33
Type/ Job affiliation	Local Authority	2	13.33
	Private sector consultant	1	6.67
	Public sector consultant	3	20.00
	Academia	4	26.67
Years of Experience	Below 5 years	none	
	5 to 10 years	3	20.00
	11 to 15 years	6	40.00
	16 to 20 years	4	26.67
	Above 20 years	2	13.33
Number of Projects	1-5	1	6.67
	6-10	4	26.67
	11-15	5	33.33
	16-20	3	20.00
	21- 30	1	6.67
	Over 30	1	6.67

## Interpretive Structural Modelling (ISM)

### *Establishment of enablers*

This section presents the results from the literature review and scoping results from the expert interview.

**Table 4.2 Identification of enablers of MS**

ID	Representative Variables (Interview)	Literature Review Variables	Sources
E1	Fair risk bearing	Fair risk sharing Balancing of risks and responsibilities	<i>Carbonara et al., 2014; Wu et al., 2018; Vassallo et al., 2012</i> <i>Storbjörk et al., 2019</i>
E2	Flexible Contracts	Relational and cooperative deals Flexible contract terms	<i>Storbjörk et al., 2019</i> <i>Sang et al., 2019, Zhang, 2009</i>
E3	Mutually beneficial Project gains	Equitable Revenue guarantee structure and sharing Fair distribution of project gains	<i>Carbonara and Pellegrino, 2018a, Chen et al. 2018</i> <i>Carbonara and Pellegrino, 2018b, Tavakoli, and Nourzad, 2020</i>
E4	Efficient financial appraisal and funding package	Strategic financial planning and package Optimum financial computation	<i>Leviäkangas et al., 2016, Carbonara and Pellegrino, 2018b</i> <i>Leviäkangas et al., 2013</i>
E5	Rational concession period and price arrangements	Reasonable Concession period Reasonable Concession price structure	<i>Zhang 2011; Zhang and Chen, 2013, Hadi and Erzajj, 2019</i> <i>Tavakoli, and Nourzad, 2020; Zhang and Chen, 2013</i>
E6	Mechanism for renegotiation of arrangements	Mechanism for renegotiation of arrangements	<i>Domingues and Zlatkovic, 2015,</i>
E7	Periodic reappraisal of project risks	Mechanism for risk reappraisal Adequate skills and knowledge capacity development	<i>Zhang 2011, Zhang and Chen, 2013</i> <i>Leviäkangas et al., 2016; Wakeford and Valentine, 2001</i>
E8	Efficient public and private sector expertise and capacity development	Technical innovation development Continuous performance improvement and innovation	<i>Wu et al., 2018</i> <i>Am et al., 2014</i>
E9	Equal involvement and active participation of stakeholders in decision making	Collaborative management and assessments Active participation of both parties	<i>Feng et al., 2019</i> <i>Am et al., 2014; Carbonara et al., 2014</i>
E10	Active coordination and communication between parties	Equal involvement of parties Coordination mechanism Effective communication and dialogue methods	<i>Shakibaei and Alpkokin, 2020</i> <i>Wakeford and Valentine, 2001</i> <i>Domingues and Zlatkovic, 2015 ; Wakeford and Valentine, 2001</i>
E11	Strategic conflict resolution and Contract negotiation	Cooperative partnership Convergence of interests in negotiation Simultaneous maximization of interests	<i>Liou et al., 2011</i> <i>Liou et al., 2011; Shakibaei and Alpkokin, 2020</i> <i>Repolho et al. 2016</i>
E12	Ensuring balance of Power between parties	Balance of power between parties Ensure equal bargaining power or stands	<i>Grimshaw et al., 2002</i> <i>Interview</i>
E13	Mutual trust and commitment	Commitment enhancement Mutual trust	<i>Domingues and Zlatkovic, 2015; Storbjörk et al., 2019</i> <i>Interview</i>

**Structural Self-Interaction Matrix (SSIM)**

The development of the SSIM reflects the pairwise relationships between the enablers. The enablers are built into a matrix where these variables are written on an X-axis and Y-axis Pane. Where Cell Eij of the matrix shows the relationship direction between variable Ei (on the X-axis) and Ej (on the Y-axis). This reveals the interpretive logic of the 13 enablers in the model. The relationships are defined as follows:

V = Ei influences or helps to achieve Ej whereas Ej does not influence or helps to achieve Ei

A = Ej influences or helps to achieve Ei whereas Ei does not influence or helps to achieve Ej

X = Ei influences or helps to achieve Ej and Ej influences or helps to achieve Ei

O = Ei and Ej are unrelated.

**Table 4.3 Structural Self-Interaction Matrix (SSIM)**

i \ j	E13	E12	E11	E10	E9	E8	E7	E6	E5	E4	E3	E2	E1
E1	X	X	X	A	A	A	V	O	V	X	V	O	X
E2	O	V	V	A	A	A	V	V	O	O	O	X	
E3	A	O	O	O	A	O	O	O	X	A	X		
E4	O	O	O	A	A	A	O	O	X	X			
E5	O	O	O	A	A	A	O	O	X				
E6	O	V	X	A	A	O	X	X					
E7	O	V	X	A	A	A	X						
E8	O	O	V	V	V	X							
E9	X	V	V	X	X								
E10	X	V	V	X									
E11	A	O	X										
E12	A	X											
E13	X												

**Reachability Matrix (RM)**

The conversion of the SSIM into a Binary Matrix is the Reachability Matrix (RM). The RM is developed by expressing the information in the SSIM in 0s and 1s. This is achieved through the application of the following conditional rules to the cells in the SSIM.

If the ij entry in the SSIM is;

- X, the (i,j) in the reachability matrix becomes 1 and the (j,i) entry becomes 1
- V, the (i,j) in the reachability matrix becomes 1 and the (j,i) entry becomes 0

- A, the (i,j) in the reachability matrix becomes 0 and the (j,i) entry becomes 1
- O, the (i,j) in the reachability matrix becomes 0 and the (j,i) entry becomes 0

Table 4.4 illustrates the results of the conversion of the SSIM to the binary matrix. For instance, cell E1/E7 is V in Table 4.3 and the resultant binary figure becomes 1 for cell E1/E7 and 0 for cell E7/E1 in Table 4.4 as per the conditions stated above.

**Table 4.4 Reachability Matrix**

ID	E1	E2	E3	E4	E5	E6	E7	E8	E9	E10	E11	E12	E13
E1	1	0	1	1	1	0	1	0	0	0	1	1	1
E2	0	1	0	0	0	1	1	0	0	0	1	1	0
E3	0	0	1	0	1	0	0	0	0	0	0	0	0
E4	1	0	1	1	1	0	0	0	0	0	0	0	0
E5	0	0	1	1	1	0	0	0	0	0	0	0	0
E6	0	0	0	0	0	1	1	0	0	0	1	1	0
E7	0	0	0	0	0	1	1	0	0	0	1	1	0
E8	1	1	0	1	1	0	1	1	1	1	1	0	0
E9	1	1	1	1	1	1	1	0	1	1	1	1	1
E10	1	1	0	1	1	1	1	0	1	1	1	1	1
E11	1	0	0	0	0	1	1	0	0	0	1	0	0
E12	1	0	0	0	0	0	0	0	0	0	0	1	0
E13	1	0	1	0	0	0	0	0	1	1	1	1	1

**Level partitioning**

This outlines the hierarchical structure of the model. To partition the variables into levels, three computations are made i.e., the reachability set, antecedent set, and intersection set. The reachability set is a set for the enablers (variables) which includes itself and any other variables with a value of one in the corresponding row. The antecedent set also includes itself and any other variables in the corresponding column. The intersection set includes the common items (variables) in both the antecedent and the reachability set. The level partitioning is done by labelling the variables (enablers) with the same items in the reachability set and the intersection set. For instance, E5 had reachability set as (3,4,5) and intersection set (3,4,5) hence qualifies to be labelled as level one. Similarly, E11 had common items of (1,6,7,11) in both the reachability and intersection sets and labelled as level one.

Next, the partitioned enablers are removed from the iteration and the reachability, antecedent and intersection sets are checked again to determine the level two partition for the remaining enablers. The enablers with the same items in the reachability and intersection sets are labelled at level two until no such similarities are identified. The enablers labelled at level two are then removed from the iteration and again the reachability, antecedent and intersection sets are checked to define the subsequent level. The same process is repeated until all the enablers are partitioned. The results are presented in table 4.5.

Table 4.5 Iteration table for level partitioning

Enablers	Reachability set	Antecedent set	Intersection set	Level
<i>Level 1</i>				
E1	1,3,4,5,7,11,12,13	1,4,8,9,10,11,12,13	1,4,11,12,13	
E2	2,6,7,11,12	2,8,9,10	2	
E3	3,5	1,3,4,5,9,13	3	
E4	1,3,4,5	1,4,5,8,9,10	1,4,5	
E5	3,4,5	1,3,4,5,8,9,10	3,4,5	I
E6	6,7,11,12	2,6,7,9,10,11	6,7,11	
E7	6,7,11,12	1,2,6,7,8,9,10,11	6,7,11	
E8	1,2,4,5,7,8,9,10,11	8	8	
E9	1,2,3,4,5,6,7,9,10,11,12,13	8,9,10,13	9,10,13	
E10	1,2,4,5,6,7,9,10,11,12,13	8,9,10,13	9,10,13	
E11	1,6,7,11	1,2,6,7,8,9,10,11,13	1,6,7,11	I
E12	1,12	1,2,6,7,9,10,12,13	1,12	I
E13	1,3,9,10,11,12,13	1,9,10,13	1,9,10,13	
<i>Level 2</i>				
E1	1,3,4,7,13	1,4,8,9,10,13	1,4,13	
E2	2,6,7	2,8,9,10	2	
E3	3	1,3,4,9,13	3	II
E4	1,3,4	1,4,8,9,10	1,4	
E6	6,7	2,6,7,9,10	6,7	II
E7	6,7	1,2,6,7,8,9,10	6,7	II
E8	1,2,4,7,8,9,10,	8	8	
E9	1,2,3,4,6,7,9,10,13	8,9,10,13	9,10,13	
E10	1,2,4,6,7,9,10,13	8,9,10,13	9,10,13	
E13	1,3,9,10,13	1,9,10,13	1,9,10,13	
<i>Level 3</i>				
E1	1,4,13	1,4,8,9,10,13	1,4,13	
E2	2	2,8,9,10	2	III
E4	1,4	1,4,8,9,10	1,4	III
E8	1,2,4,8,9,10	8	8	
E9	1,2,4,9,10,13	8,9,10,13	9,10,13	
E10	1,2,4,9,10,13	8,9,10,13	9,10,13	
E13	1,9,10,13	1,9,10,13	1,9,10,13	III
<i>Level 4</i>				
E1	1	1,8,9,10	1	IV
E8	1,8,9,10	8	8	
E9	1,9,10	8,9,10	9,10	
E10	1,9,10	8,9,10	9,10	
<i>Level 5</i>				
E8	8,9,10	8	8	
E9	9,10	8,9,10	9,10	V
E10	9,10	8,9,10	9,10	V
<i>Level 6</i>				
E8	8	8	8	VI



Results show that E8 “Efficient public and private sector expertise and capacity development” and E1 “Fair risk-bearing” were the enablers solely captured in a level i.e., levels VI and IV respectively. Furthermore, E12 “ensuring balance of power between parties”, E11 “strategic conflict resolution and contract negotiation” and E5 “rational concession period and price arrangements” are captured as level I. Also, E6, E3, and E7 namely, mechanism for renegotiation of arrangements, mutually beneficial project gains, and periodic reappraisal of project risks were captured in level II. The fifth level includes equal involvement and active participation of stakeholders in decision making and the active coordination and communication between parties.

**ISM-based Model.**

This is developed based on the relationships captured in the reachability matrix and partitioning levels. The results from the transitivity checks as described in the ISM steps showed the existence of very dense transitive links among the variables affirming the hypothetical stand of the study that the enablers act as a system of interacting factors that affect each other and should function jointly. The connectivity between the enablers show that they act collectively in the achievement of mutual satisfaction. The structural model shown in Figure 1 depicts significant links.

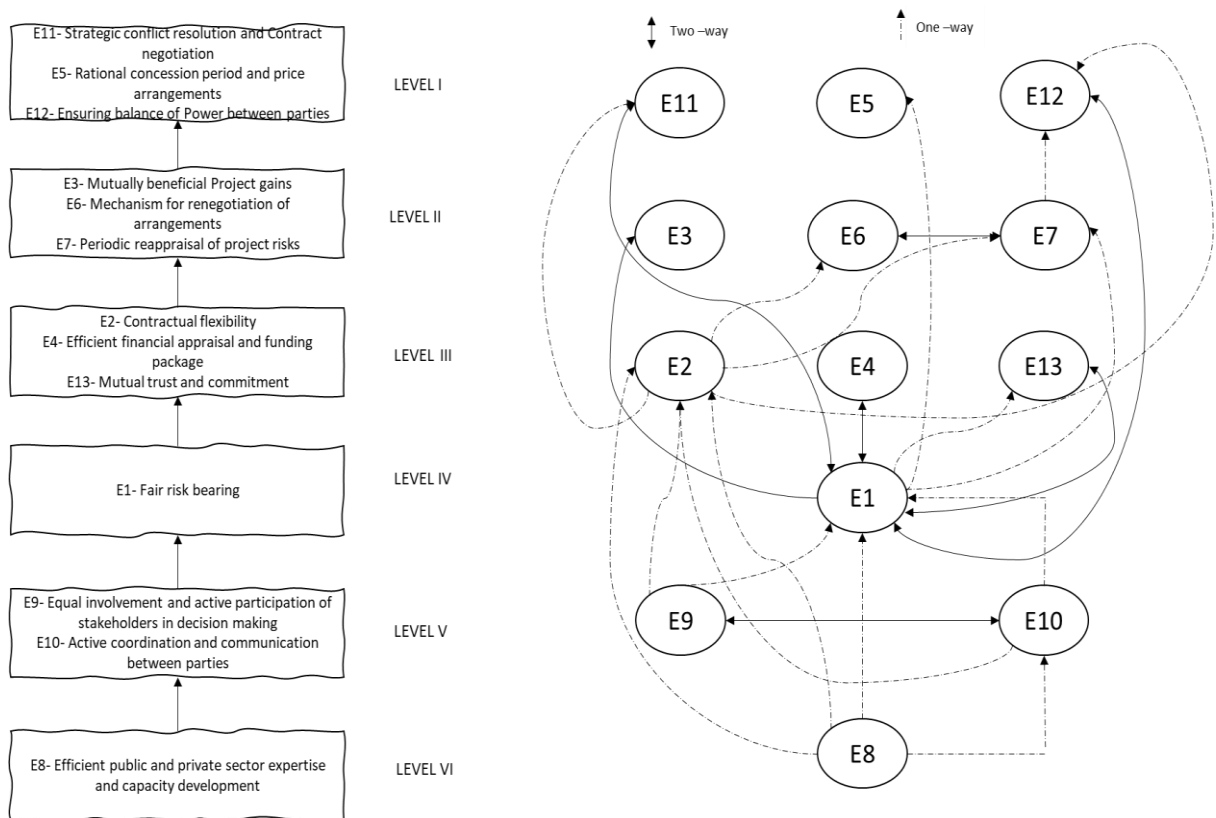

Figure 1; ISM based Model

The model gives a systemic view of the enablers for achieving MS. The results indicate that the top enablers include E12 “ensuring balance of power between parties” E11 “strategic conflict resolution and contract negotiation” and E5 “rational concession period and price arrangements” however the efficient public and private sector expertise and capacity development (E8) at the bottom of the system

should be focused on since it initiates and forms the bedrock of the structure. Falling at the base of the structure means it influences all the other enabling factors hence the quest for MS should begin with deliberate capacity development of both private and public sectors. Furthermore, the equal involvement and active participation of stakeholders in decision making (E9) as well as active coordination and communication between parties (E10) promotes the attainment of MS and contributes to the fair sharing of risks and so on.

**MICMAC analysis**

This creates an improved interpretation of the behavior of the enablers in the model. This analysis was much needed in this study due to the complex nature of the links between the enablers. The main objective of this analysis is to determine and assess the driving and dependency powers of the enablers. The driving power is the sum of 1s on the rows and the dependency variables the sum of 1s on the column from the reachability matrix. These values are presented in table 4.6 and form the X and Y axis used in plotting the graph shown in figure 3. The MICMAC analysis groups the enablers into four clusters namely independent, linkage, autonomous and dependent variables.

**Table 4.6 Driving and Dependency powers**

Enablers of MS	E1	E2	E3	E4	E5	E6	E7	E8	E9	E10	E11	E12	E13
Driving power (y-axis)	8	5	2	4	3	4	4	9	12	11	4	2	7
Dependency power (x-axis)	8	4	6	6	7	6	8	1	4	4	9	8	4

The inputs of table 4.6 is used in plotting the graph for the MICMAC analysis. The graph is divided into four equal quadrants as shown the figure 3. The top right corner is the linkage quadrant while the top left is the independent quadrant. The bottom right is the dependent and the bottom left is the autonomous quadrant.

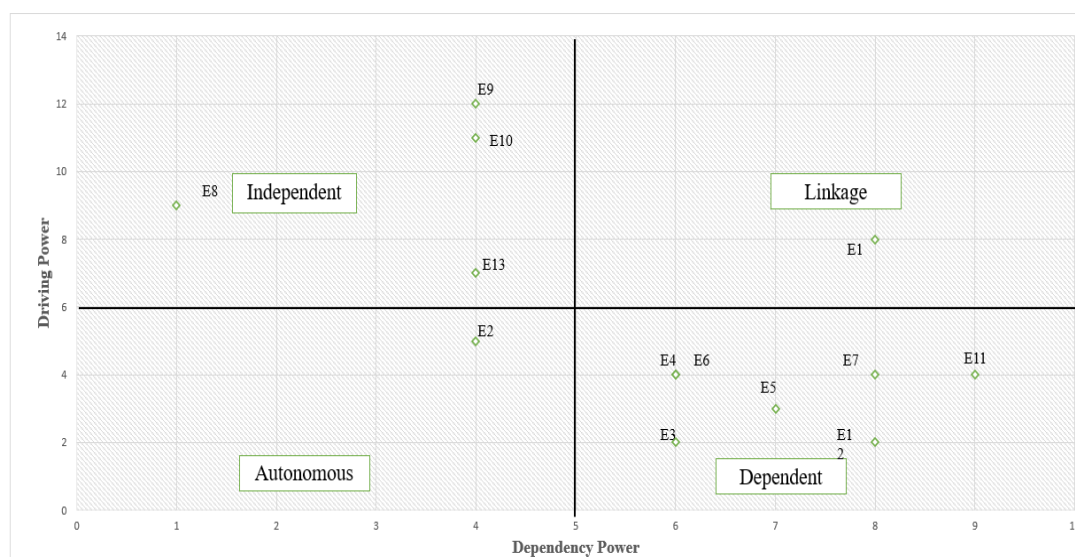

Figure 2; MICMAC Analysis of enablers.

Q1- Independent enablers; these are the enablers that exhibit a high driving power with low dependency power. They include efficient public and private sector expertise and capacity development, mutual trust and commitment, active

coordination and communication between parties and equal involvement and active participation of stakeholders in decision making. It is evident that these independent enablers are unique in classification as they refer to the people or human actors (i.e. the private and public sector stakeholders) involved in the partnership.

Q2- Linkage enablers: these are the enablers with both strong driving and dependence power. These are the variables that are unstable and any action on these variables will have an effect on the others at the same time have feedback on themselves. The enabler in that category is the fair risk-bearing.

Q3- Autonomous enabler- these are considered are those variables somewhat disconnected from the system since they have low dependency and driving powers. Flexible contracts belong to the autonomous group in this study.

Q4- Dependent enablers- they have high dependency power with low driving power namely efficient financial appraisal and funding package, mechanism for renegotiation of arrangements, rational concession period and price arrangements, periodic reappraisal of project risks, strategic conflict resolution and contract negotiation, mutually beneficial project gains and ensuring balance of power between parties. These enablers rely on other factors to be established.

## **Discussion**

Parties to any infrastructure project execution desire to meet their individual interests and motives for engaging in that partnership. The expert-based ISM model developed in this study generally affirms the hypothetical claim that the achievement of MS acts as an ecosystem of factors interacting with each other. This was also captured by Eshun et al.,(2020) in their study of conceptualising a win-win scenario in public-private infrastructure partnerships. The modelling shows that the quest for MS in Sino-Ghana relations relies on the two major actors involved. The capacity and character exhibited by these parties go a long way to affect all the other enablers in the system shown in Figure 2. This agrees with a study by Ndzendze and Monyae (2019) which concluded that the realisation of maximum mutual benefit in these dealings requires additional and concerted effort from both China and the authorities of these African countries. Auffray and Fu, (2015) from their Sino-Ghana study established that there is lack of managerial knowledge on the part of the project actors which requires more effort to improve. These actors must display a commendable degree of trust and commitment while ensuring a balanced representation of stakeholders in decision making on the project (Grimshaw et al., 2002; Feng et al, 2019). The use of flexible contracts is a step in the right direction for MS as it provides the opportunity to reappraise and make rational adjustments to terms susceptible to uncertainties (Storbjörk et al.,2019). According to Domingues, and Zlatkovic, (2015), renegotiation of contract terms facilitates MS as a way of adjusting to real time project dynamics. The basis of transnational PPPs falls on the interest of the actors and the treatment of risk. MS can be achieved if partnerships ensure fair sharing of risks as well as developing financial models that are mutually beneficial and project reasonable payback terms (Carbonara et al., 2014; Tavakoli, and Nourzad, 2020). Shakibaei and Alpkokin, (2020) asserted that parties to any infrastructure project with the desire to meet or fulfil each other's interest must be strategic about negotiation. The negotiation

process allows both parties to solicit win-win or MS goals and reach a fair ground favourable to all. Strategic negotiation should be planned such that both parties display equal bargaining power to prevent asymmetry of terms towards the party with the upper hand (Grimshaw et al., 2002). This will prevent the leader-follower perception of some studies regarding China-Africa infrastructure partnerships (Shi et al., 2020). Strategic negotiation as an enabler for MS does not only capture the procurement stage but negotiations when conflicts arise. Shakibaei and Alpkokin, (2020) purported that conflict resolution strategies adopted by the project stakeholders can influence the achievement of MS during execution.

## **CONCLUSION AND IMPLICATIONS**

Generally, the involvement of the private sector to co-govern and administer the provision of public infrastructure i.e., TPPPs tend to project varying interests, power imbalance and opportunistic behaviour. The unique nature of Chinese corporations investing in Ghana and Africa at large is that these firms are state-owned. This positions the study in the theoretical lens of international relations and governance beyond the state. Though the role of the Chinese state and its organisations in Africa have been considered by some studies as generally pessimistic, further reading suggests that this assertion can be contested. This has drawn a cross perception between these actors and is gradually and consciously fuelling the need to thrive for mutual benefits built on strategic partnership deals and activities. The TPPP lens used in this study provides a well-structured and commonly recognised procurement route that facilitates the objective determination of factors that enable the achievement of mutual satisfaction in Sino-Africa relations at large. The achievement of mutual satisfaction or win-win portrays the desire to achieve project success in fairness to both actors (China and Ghana). Given the established desire for MS, this study aimed at identifying, assessing, and modelling factors that enable the achievement of MS in TPPPs. This was achieved through literature review and expert judgement based on semi-structured interviews and the ISM instrument. The ISM approach was used to establish the relationships and connections between the enablers as a system. Results indicate that attaining MS is processual and involves taking certain measures and activities while focusing on how they influence or affect each other. The MS model presented in this study was developed based on system principles which means that the enablers identified must act collectively for a better realisation of MS in TPPPs. For instance, having fairly shared risks without allowing some contractual flexibility that enables reappraisal of risks to adapt to reality during project implementation defies the course of promoting MS or win-win. These enablers can be used in establishing determinants, unique to the actors involved in the TPPPs and evaluated to predict the tendency of MS achievement from that partnership. Further investigation can be done to assess the shortfall of Sino-Ghana infrastructure partnerships in relation to the quest for MS and findings can be prioritised in planning such partnerships. In view of this, policies and well-defined structures can be put in place to manage Sino-Ghana infrastructure partnerships to ensure mutual satisfaction, promote more of such engagements and strengthen cooperation ties.

### **Acknowledgement**

This paper which forms part of a broader research scope is funded by the Research Grant Council of Hong Kong through the Hong Kong PhD Fellowship scheme.

## REFERENCES

- Auffray, C., & Fu, X. (2015). Chinese MNEs and managerial knowledge transfer in Africa: the case of the construction sector in Ghana. *Journal of Chinese Economic and Business Studies*, 13(4), 285-310. doi:10.1080/14765284.2015.1092415
- Ajakaiye, O., & Ncube, M. (2010). Infrastructure and economic development in Africa: An overview. *Journal of African Economies*, 19(suppl\_1), i3-i12.
- Akyeampong, E., & Fofack, H. (2019). Special issue on 'Africa and China: Emerging patterns of engagement'.
- Am, K., & Heiberg, S. (2014), "Public-private partnership for improved hydrocarbon recovery—lessons from Norway's major development programs", *Energy Strategy Reviews*, Vol. 3, pp. 30-48.
- Angermuller, J., Maingueneau, D., & Wodak, R. (2014). The discourse studies reader. an introduction. *The discourse reader, Main theories and Analysis*. Amsterdam, Philadelphia: John Benjamins, 16-36
- Bhandari, S., & Hallowell, M. R. J. J. O. M. I. E. (2021). Identifying and Controlling Biases in Expert-Opinion Research: Guidelines for Variations of Delphi, Nominal Group Technique, and Focus Groups. 37(3), 04021015.
- Carbonara, N., & Pellegrino, R. (2018a), "Revenue guarantee in public-private partnerships: a win-win model", *Construction Management and Economics*, Vol. 36 No. 10, pp. 584-598, doi: 10.1080/01446193.2018.1467028
- Carbonara, N., & Pellegrino, R. (2018b), "Public-private partnerships for energy efficiency projects: a win-win model to choose the energy performance contracting structure", *Journal of Cleaner Production*, Vol. 170, pp. 1064-1075, doi: 10.1016/j.jclepro.2017.09.15
- Carbonara, N., Costantino, N., & Pellegrino, R. (2014), "Concession period for PPPs: a win-win model for a fair risk sharing", *International Journal of Project Management*, Vol. 32 No. 7, pp. 1223-1232, doi: 10.1016/j.ijproman.2014.01.007
- Chen, Q., Shen, G., Xue, F., & Xia, B. (2018), "Real options model of toll-adjustment mechanism in concession contracts of toll road projects", *Journal of Management in Engineering*, Vol. 34 No. 1, doi: 10.1061/(ASCE)ME.1943-5479.0000558.
- Cheng, E. W. (2019). *Public-Private Partnerships for Critical Infrastructure Development: The Hong Kong Experience*. In *Public Private Partnerships* (pp. 207-232). Springer, Cham.
- Domingues, S., & Zlatkovic, D. (2015), "Renegotiating PPP contracts: reinforcing the 'p' in partnership", *Transport Reviews*, Vol. 35 No. 2, pp. 204-225
- Eshun, B. T. B., Chan, A. P., & Osei-Kyei, R. (2020). Conceptualizing a win-win scenario in public-private partnerships: evidence from a systematic literature review. *Engineering, Construction and Architectural Management*.
- Feng, L., Liu, L., & Zhang, H. (2019), "Game theory-based pathway selection for fair and reciprocal cooperation among ports along the maritime silk road", *Mathematical Problems in Engineering*, Vol. 2019, doi: 10.1155/2019/2812418.
- Grimshaw, D., Vincent, S., & Willmott, H. (2002). Going privately: partnership and outsourcing in UK public services. *Public Administration*, 80(3), 475-502
- Gocking, R. (2020). Ghana's Bui Dam and the Contestation over Hydro Power in Africa. *African Studies Review*. doi:10.1017/asr.2020.41.

- Habiyaremye, A., & Oğuzlu, T. (2014). Engagement with Africa: Making sense of Turkey's approach in the context of growing East-West rivalry. *Uluslararası İlişkiler*, 11(41), 65-85. doi:10.33458/uidergisi.553344
- Hadi, A. H., & Erzaj, K. R. (2019), "Determination a reasonable concession period for (PPP) projects", *Civil Engineering Journal-Tehran*, Vol. 5 No. 6, pp. 1235-1248, doi: 10.28991/cej2019-03091328
- Kobylińska, U. (2017). Barriers and Factors Influencing the Level of Cooperation of Businesses with Public Administration Institutes: Poland as a Case Study. *Economic and Social Development: Book of Proceedings*, 222-231
- Leviakangas, P., Kinnunen, T., & Aapaoja, A. (2016), "Infrastructure public-private partnership project ecosystem-financial and economic positioning of stakeholders", *The European Journal of Finance*, Vol. 22 No. 3, pp. 221-236
- Leviakangas, P., Wigan, M., & Haapasalo, H. (2013), "Financial anatomy of E4 Helsinki-Lahti shadow toll PPP-project", *Built Environment Project and Asset Management*, Vol. 3 No. 2, pp. 165-180, doi: 10.1108/BEPAM-04-2012-0017
- Liou, F. M., Yang, C. H., Chen, B., & Chen, W. (2011), "Identifying the pareto-front approximation for negotiations of BOT contracts with a multi-objective genetic algorithm", *Construction Management and Economics*, Vol. 29 No. 5, pp. 535-548, doi: 10.1080/01446193.2011.564196
- Mitullah, W. V., Samson, R., Wambua, P. M., & Balongo, S. (2016). Building on progress: Infrastructure development still a major challenge in Africa.
- Ndzendze, B., & Monyae, D. (2019). China's belt and road initiative: linkages with the African Union's Agenda 2063 in historical perspective. *Transnational Corporations Review*, 11(1), 38-49. doi:10.1080/19186444.2019.1578160.
- Odoom, I. (2017). Dam In, Cocoa Out; Pipes In, Oil Out: China's Engagement in Ghana's Energy Sector. *Journal of Asian and African Studies*, 52(5), 598-620. doi:10.1177/0021909615599419
- Park, M. J., & Jun, H. J. A. I. S. R. (2016). New Perspectives on Transnational Public-Private Partnerships: A Critical Analysis of the United Nations-Business Partnership. 17(1), 37-54.
- Poduval, P. S., & Pramod, V. R. (2015). Interpretive structural modeling (ISM) and its application in analyzing factors inhibiting implementation of total productive maintenance (TPM). *International Journal of Quality & Reliability Management*.
- Saka, A. B., Chan, D. W., & Siu, F. M. (2020). Drivers of sustainable adoption of building information modelling (BIM) in the Nigerian construction small and medium-sized enterprises (SMEs). *Sustainability*, 12(9), 3710.
- Sang, J., Li, Z.C., Lam, W.H.K. and Wong, S.C. (2019), "Design of build-operate-transfer contract for integrated rail and property development with uncertainty in future urban population", *Transportation Research Part B: Methodological*, Vol. 130, pp. 36-66, doi: 10.1016/j.trb.2019. 10.003.
- Schäferhoff, M., Campe, S., & Kaan, C. J. I. S. R. (2009). Transnational public-private partnerships in international relations: Making sense of concepts, research frameworks, and results. 11(3), 451-474.
- Shakibaei, S., & Alpkokin, P. (2020), "Conflict resolution in competitive liberalized railway market: application of game theoretic concepts", *International Game Theory Review*, Vol. 22 No. 1, doi: 10.1142/S0219198919500130

- Shen, L., Song, X., Wu, Y., Liao, S., & Zhang, X. (2016). Interpretive Structural Modeling based factor analysis on the implementation of Emission Trading System in the Chinese building sector. *J. Clean. Prod.* 127, 214e227
- Sohani, N., & Sohani, N. (2012). Developing interpretive structural model for quality framework in higher education: Indian context. *Journal of Engineering, Science & Management Education*, 5(2), 495-501.
- Storbjork, S., Hjerpe, M., & Glaas, E. (2019), "Using public-private interplay to climate-proof urban planning? Critical lessons from developing a new housing district in Karlstad, Sweden", *Journal of Environmental Planning and Management*, Vol. 62 No. 4, pp. 568-585, doi: 10.1080/09640568.2018.1434490.
- Tavakoli, N., & Nourzad, S. H. H. (2020), "Win-win pricing method for BOT projects using a simulation-based evolutionary optimization", *Construction Management and Economics*, Vol. 38 No. 2, pp. 157-171, doi: 10.1080/01446193.2019.1657234
- Ubi, E. N. (2014). Foreign Aid and Development in Sino-African Relations. *Journal of Developing Societies*, 30(3), 243-272. doi:10.1177/0169796X14536971
- Vassallo, J. M., Ortega, A., & Baeza, M. D. L. A. (2012), "Impact of the economic recession on toll highway concessions in Spain", *Journal of Management in Engineering*, Vol. 28 No. 4, pp. 398-406.
- Wakeford, J., & Valentine, J. (2001), "Learning through partnership: private finance and management in the delivery of services for London", *Public Money and Management*, Vol. 21 No. 4, pp. 19-26, doi: 10.1111/1467-9302.00281.
- Wang, Z., Lu, Y., Zhang, S., & Negash, E. S. (2020). ANALYSIS of the BRI and CHINA'S OFDI in SUB-SAHARAN AFRICA. *Singapore Economic Review*. doi:10.1142/S0217590820500496
- Wu, Y., Song, Z., Li, L., & Xu, R. (2018), "Risk management of public-private partnership charging infrastructure projects in China based on a three-dimension framework", *Energy*, Vol. 165, pp. 1089-1101, doi: 10.1016/j.energy.2018.09.092
- Xu, X., & Zou, P. X. J. J. O. C. P. (2020). Analysis of factors and their hierarchical relationships influencing building energy performance using interpretive structural modelling (ISM) approach. 272, 122650.
- Yu, S. X., Qian, & Liu, T. (2019). Belt and road initiative and Chinese firms 'outward foreign direct investment. *Emerging Markets Review*, 41, 100629. <https://doi.org/10.1016/j.ememar.2019.100629>
- Zhang, J., Ilan, A., & Yanan, C.(2014), "Does Chinese investment affect sub-Saharan African growth?", *International Journal of Emerging Markets*, Vol. 9 No. 2, pp. 257-275.
- Zhang, X. (2009), "Win-win concession period determination methodology", *Journal of Construction Engineering and Management*, Vol. 135 No. 6, pp. 550-558
- Zhang, X. (2011), "Web-based concession period analysis system", *Expert Systems with Applications*, Vol. 38 No. 11, pp. 13532-13542, doi: 10.1016/j.eswa.2011.04.030
- Zhang, X., & Chen, S. (2013), "A systematic framework for infrastructure development through public private partnerships", *IATSS Research*, Vol. 36 No. 2, pp. 88-97, doi: 10.1016/j.iatssr.2012.11.001.



## EVALUATION OF HEALTH AND SAFETY COMPLIANCE OF CONSTRUCTION PROJECTS IN SOUTH EAST NIGERIA

Chidinma Amarachukwu Emma-Ochu<sup>1</sup>, Kevin C. Okolie<sup>2</sup> and Ikem Mbamali<sup>3</sup>

<sup>1</sup>*Department of Architecture, Federal Polytechnic Nekede, Owerri, Imo State, Nigeria*

<sup>2</sup>*Department of Building, Nnamdi Azikiwe University, Awka, Anambra State, Nigeria*

<sup>3</sup>*Department of Building, Ahmadu Bello University Zaria, Kaduna State, Nigeria*

This research is about the evaluation of the level of construction projects compliance to health and safety regulations (South East Nigeria) with a view to identifying action plans for enhancing the compliance in South East Nigeria. This study which is essentially survey based and empirical, where quantitative data and qualitative data was derived from responses generated by the questionnaire survey and field work. The questionnaires were administered to indigenous construction firms and professionals in the construction industry in Abia, Anambra, Imo, Enugu and Ebonyi States of the South East area of Nigeria which are the study population. The tools used for data analysis were Regression using Friedman Q Test Ranking, cross tab, while descriptive statistics used for analyzing others include bar charts, pie charts, tables, chi square, and ranking analysis. All hypotheses were tested at 5% level of significance. The findings revealed that there is association in level of compliance in construction projects to existing Health and Safety (H&S) regulations in South East Nigeria. The study further reveals that the challenges affecting health and safety compliance in South East Nigeria are bribery and corruption, ignorance of the benefits of compliance, lack of health and safety culture, perception of stakeholders, neglect of human rights and moral values, non-commitment of the major construction players, inadequate training of staff and lack of skilled health and safety personnel, non-inclusion of health and safety in contract document & tendering process and inadequate funding. The research also found out that there is significant relationship between health/safety regulations and enforcement of health and safety measures in South East Nigeria and that there is significant positive relationship between health/safety regulations and Action plan for enhancing health safety measures in South East Nigeria. It therefore concludes that effective health and safety practices and planning for construction projects in South East Nigeria are yet to be fully appreciated and implemented among construction firms. This study observes that the lack of awareness and understanding of H&S significantly hinders H&S. The study recommended that to ensure high level of compliance in all the states, allocating H&S responsibilities, which are bound by local laws, will significantly contribute to improving H&S and there should be workable and mandatory H&S consultants for every project. Also the stakeholders in the construction industry (e.g. clients and professionals) should team up to provide enforceable Health and Safety practices and plans that are in sync with health/safety regulations in the Nigerian construction industry and the world at large.

Keywords: construction, construction projects, health, health and safety, safety compliance, safety

<sup>1</sup> chidinmaeochu@gmail.com

<sup>2</sup> Kc.Okolie@unizik.edu.ng

<sup>3</sup> mbamalikem@yahoo.com



## INTRODUCTION

The development of sustainable health and safety environments is becoming one of the key issues globally. The issue of health and safety standards especially in the construction industry in Nigeria has been a source of concern to many authors. It is the view of Umeokafor, Umeadi, Jones & Igwegbe (2014), that in Nigeria, the industry is not covered by any local health and safety (H&S) law, consequently some contractors in Nigeria adopt H&S standards from developed countries and the National Building Code of 2006 which is yet to receive legislative backings.

Okoye, Ezeokonkwo & Ezeokoli (2016) posited that the enforcement of safety regulation is not widespread within the industry. As a result, construction workers are killed or injured and suffer ill health than in any other industry. Dodo (2014), stated that the first effort to regulate and control health and safety of work in Nigeria was the factory Act of 1958 but unfortunately there is lack of provision for enforcement of health and safety standard in the construction industry. Health and Safety on Construction sites is imperative to provide safe working conditions to construction workers due to intrinsic hazards and risks associated with every work situation (Olotuase, 2014). Nigeria adopted the OSH regulatory framework of US & UK which is supposed to be enforced by the Federal Ministry of Labour and Productivity. The OSH regulations have to be encompassing, comprehensive and enforceable for it to be effective and functional. The National Policy on Occupational Safety and Health which has great goals and objectives of creating a general framework for the improvement of working conditions and the working environment, prevent accidents, ensure the provision of occupational safety and health services to workers in all sectors of economic activity has not been able to achieve these great goals and objectives due to many factors. The appraisal and identification of the factors are the focus of this work.

### **Significance and motivation**

This study will evaluate the level of construction projects compliance to health and safety regulations in South East Nigeria with a view to identifying action plans for enhancing the compliance by determining the level of compliance of construction projects to existing health and safety regulations in South East Nigeria, identifying health and safety compliance challenges of construction projects in South East Nigeria and examining the relationship between enforcement of health and safety measures and health and safety regulations, action plans for enhancing health and safety measures and health and safety regulations in construction sites of South East Nigeria.

This study provides a synopsis of previous construction safety research in Nigeria in order to highlight the current state of the industry and direct future research.

The level of compliance of construction projects to existing health and safety regulations in the South East states of Nigeria can be checked from what is applicable at the Federal since the factories Act F1 LFN 2004 empowers the Federal Ministry of Labour and employment (Inspectorate Division)(LPID) to oversee H&S including enforcement. The state controllers 'maintain contact with headquarters office in Abuja. The level of compliance to existing health and safety regulations in the South East states is low due to lack of proper enforcement by existing authority.

The study done by Okoye et al. (2016), on Nigeria construction sites and Anambra State in particular, examined and found out that the level of health and safety knowledge among construction workers in Anambra State was moderate, the level of health and safety compliance, in the state among the workers was low, the study further established a very weak positive correlation between the health and safety knowledge and compliance of construction workers. It further averred that health and safety knowledge and compliance alone are not enough to cause behavioral changes but safety factors like enforceable regulatory framework, management commitment etc. Despite the tremendous infrastructural development both in building projects and road construction going on in the five states in the South East of Nigeria (Abia, Anambra, Imo, Enugu, and Ebonyi), most of these projects are handled by indigenous contractors and there have been cases of construction sites accidents which are not reported. According to Okoye et al. (2016), the increasing level of building collapse together with the government renewed effort in ensuring its minimization through institution of various monitoring and compliance teams have raised the awareness level of safety issues in construction sites in the South East but the construction workers compliance to these health and safety regulations are still low. There is therefore the need for construction organizations in the South East to improve their health and safety knowledge, compliance and project performance. Given these highlighted deficiencies, it is pertinent to further examine the challenges affecting the compliance of H&S regulations in Nigeria. Umeokafor (2017) opines that the Nigerian construction industry like other industries faces challenges which are not limited to: lack of skilled manpower, unstable prices of materials, poor implementation of policies, political instability, corruption, unethical practices but corruption is the major hindrance to the construction industry.

According to Omobolanle & John (2017), Nigeria, the largest African country is beleaguered with bribery and corruption, and Transparency International (2012) ranks the country 139 out of 176 in terms of the corruption perception index. Rantanen (2005), Ezenwa (2001), Cheung et al. (2004), Diugwu et al. (2012), Windapo, 2013, Idubor and Osiamoje (2013) identified ignorance of the benefits of compliance, lack of health and safety culture, perception of stakeholders, neglect of human rights and moral values, non-commitment of the major construction players, inadequate training of staff and lack of skilled health and safety personnel, non-inclusion of health and safety in contract document & tendering process and inadequate funding as challenges affecting the compliance of H&S regulations in Nigeria amongst others.

In Nigeria, there are legislations and guidelines on health and safety but employers do not comply with basic legislations to protect people at work. Barker in Ngwama 2016 observed that deregulation; subcontracting and informal contractual conditions make this situation even worse. Workers often have no choice – either they take a dirty and dangerous job, or they will have no job at all. Thankfully, the new Bill (The Labour, Safety, Health and Welfare Bill of 2012) addresses all the above issues, as it includes the construction industry in the definition of its premises and stipulates severe penalties for violation. This bill covers both the formal and informal industrial sectors in Nigeria. It seeks to repeal the Factories Act and serve as a comprehensive OSH legislation for the workplace.

## METHODOLOGY

This paper evaluates the level of construction projects compliance to health and safety regulations in South East Nigeria with a view to identifying action plans for enhancing the compliance. The research sample was drawn from registered professionals in study area (South East area of Nigeria) and indigenous construction firms as shown in Table 1 and Table 2 and structured questionnaires were administered to them. South East of Nigeria is one of the six geopolitical zones in the country. The region consists of the following states; Abia, Anambra, Imo, Enugu and Ebonyi. The data for the study were collected from Umuahia in Abia, Awka in Anambra, Owerri in Imo, Enugu in Enugu, and Abakiliki in Ebonyi. The questionnaires were distributed to 1400 respondents in the five (5) states in the South East of Nigeria that are knowledgeable and willing to participate but 1300 were retrieved but only One thousand one hundred and ninety (1190) copies were validated for analysis. (See Figure 1). Descriptive analysis was applied on categorical variables such as State, gender, designation of respondent and experience. Ordinary Least Squares Regression Model was used to depict significant predictors of Enforcement of Health and Safety Regulations (ENF) and Action Plans for Enhancing Health and Safety Compliance (APH). Statistics were summarized in tables and charts. Statistics were discussed at the 95% CL (Alpha=0.05) and presented using statistical tables and charts.

## FINDINGS AND DISCUSSION

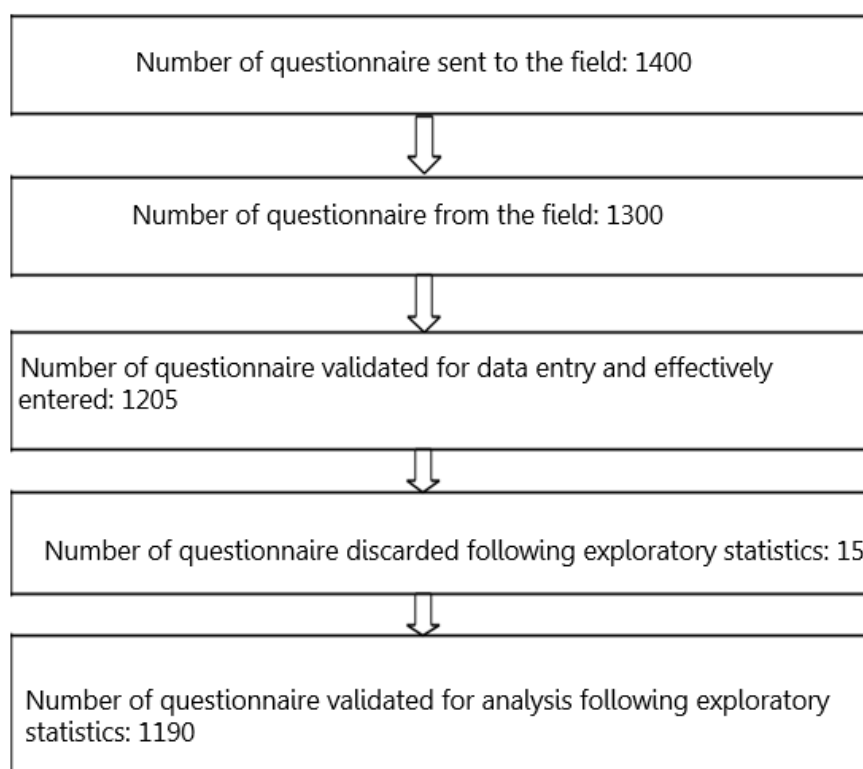

Figure 1: Sample flow chart

**Table 1: Registered professionals in study area**

S/N	STATE	ARCHITECTS	BUILDERS	ENGINEERS	TOTAL
1	Abia (Umuahia)	25	20	30	75
2	Anambra (Awka)	35	40	45	120
3	Imo (Owerri)	70	30	250	350
4	Enugu (Enugu)	150	50	180	380
5	Ebonyi(Abakiliki)	20	52	80	152
	Total	300	192	585	1077

Source: Secretariat of various professional bodies (NIA-Nigerian Institute of Architects, NIOB-Nigerian Institute of Builders, NSE-Nigerian Society of Engineers, NITP-Nigerian Institute of Town Planners) 2020

**Table 2: Indigenous contractors**

S/N	STATE	CONTRACTORS
1	Abia (Umuahia)	20
2	Anambra (Awka)	70
3	Imo (Owerri)	60
4	Enugu (Enugu)	80
5	Ebonyi(Abakiliki)	30
	Total	260

Source: Secretariat of various professional bodies (NIA-Nigerian Institute of Architects, NIOB-Nigerian Institute of Builders, NSE-Nigerian Society of Engineers, NITP-Nigerian Institute of Town Planners) 2020

**Table 3: States sampled for the study**

	STATE	Frequency	Percent	Valid Percent	Cumulative Percent
Valid	ABIA	124	10.4	10.4	10.4
	ANAMBRA	272	22.9	22.9	33.3
	IMO	420	35.3	35.3	68.6
	ENUGU	280	23.5	23.5	92.1
	EBONYI	94	7.9	7.9	100.0
	Total	1190	100.0	100.0	

Source: Survey Questionnaire of the Study, 2020

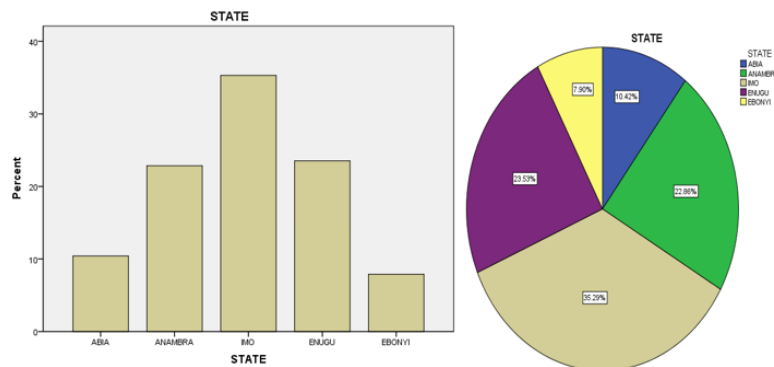

Figure 2: Bar chat and pie chart of sampled States for the study.

Source: Survey Questionnaire of the Study extracted from SPSS output, 2020

Each of the five States of our sample was allotted questionnaires; however the following returns were made (Table 3 and Fig.2): Abia with 124 participants making a proportion of 10.4%, Anambra having a proportion of 272 (22.9%), Imo 420 (35.3%), Enugu 280 (23.5%) and Ebonyi 94 (7.9%). The implication here is that Imo State has the highest number of participant while Ebonyi State has the lowest number of participants.

**Table 4: Gender sampled for the study**

Gender	Frequency	Percent	Valid Percent	Cumulative Percent
Valid MALE	926	77.8	77.8	77.8
FEMALE	264	22.2	22.2	100.0
Total	1190	100.0	100.0	

Source: Survey Questionnaire of the Study, 2020

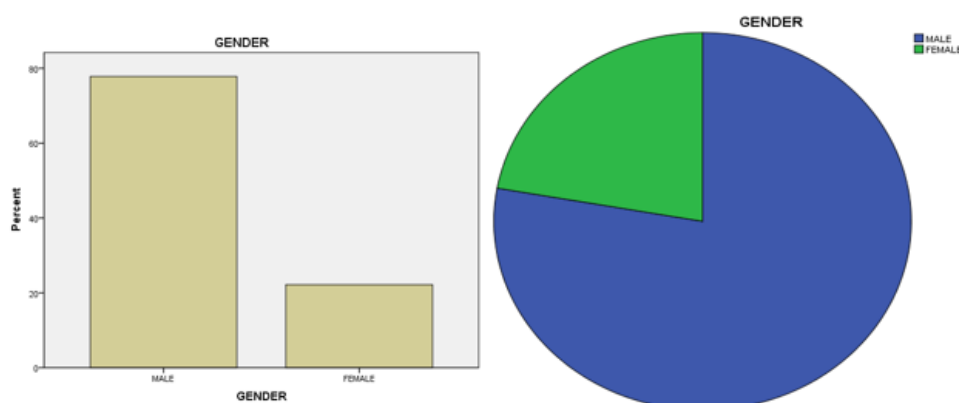

Figure 3: Bar chat and pie chart of sampled gender for the study.

Source: Survey Questionnaire of the Study extracted from SPSS output, 2020

From Table 4 and Figure 3, participants were essentially male with a proportion of 926 (77.8%) as against 264 (22.2%) of the female. it is evidently clear that males dominate the Construction sector of the Nigerian economy.

**Table 5: Designation of respondent sampled for the study**

DESIGNATION	Frequency	Percent	Valid Percent	Cumulative Percent
ARCHITECT	343	28.8	28.8	28.8
BUILDER	168	14.1	14.1	42.9
ENGINEER	163	13.7	13.7	56.6
QUANTITY SURV	212	17.8	17.8	74.5
ESTATE VALUER	124	10.4	10.4	84.9
URBAN REG P	44	3.7	3.7	88.6
CONTRACTORS	136	11.4	11.4	100.0
Total	1190	100.0	100.0	

Source: Survey Questionnaire of the Study, 2020

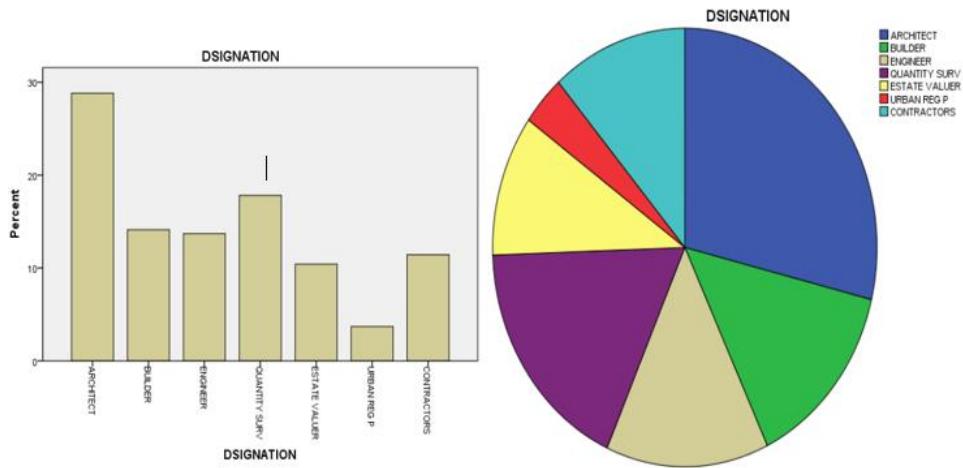

Figure 4: Bar chat and pie chart of sampled designation for the study.  
Source: Survey Questionnaire of the Study extracted from SPSS output, 2020

In these five States, Architects are 343 participants making a proportion of 28.8%, Builders have a proportion of 168 (14.1%), Engineers 163 (13.7%), Quantity Surveyor 212 (17.8%), Estate Valuers 124 (10.4%), Urban and Regional Planners 44 (3.7%) and Contractors 136 (11.4%). The implication is that Architects have the highest number of participants while Urban and Regional Planners have the lowest number of participants, across States. (Table 5 and Figure 4).

Table 6: Experience in years of respondent sampled for the study

EXPERIENCE	Frequency	Percent	Valid Percent	Cumulative Percent
Valid BTW 1&5YRS	503	42.3	42.3	42.3
BTW 6&10YRS	269	22.6	22.6	64.9
BTW 11 &15YRS	259	21.8	21.6	86.6
ABOV 16YRS	159	13.4	13.4	100.0
Total	1190	100.0	100.0	

Source: Survey Questionnaire of the Study, 2020

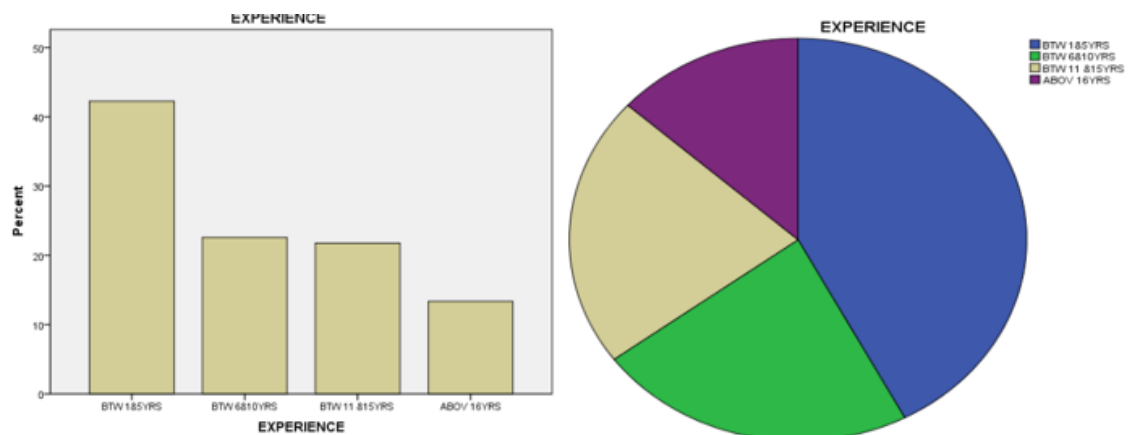

Figure 5: Bar chat and pie chart of sampled designation for the study.  
Source: Survey Questionnaire of the Study extracted from SPSS output, 2020

Cursory examination of table 6 and figure 5 reveals that those with years of experience between 1- 5 years are 503 making a proportion of 42.3%, 6-10 years have a proportion of 269 (22.6%), 11-15 years 259 (21.8%) and above 16 years 159 (13.4%). The implication is that cumulatively those with experience between one year and fifteen years occupy 86.6% of how long in Practice.

**Table 7: Friedman Q test ranking challenges to health and safety compliance in South East, Nigeria.**

ITEMS	MEAN RANK
NON-INCLUSION OF H&S IN CONTRACT DOCUMENT & TENDERING PROCESS (9)	4.92
Non commitment of the major construction players (6)	5.33
INADEQUATE FUNDING (10)	4.86
INADEQUATE TRAINING OF STAFF (7)	5.28
LACK OF H&S CULTURE (3)	5.73
PERCEPTION OF STAKEHOLDERS (E.G. CLIENTS AND PROFESSIONALS) (4)	5.59
LACK OF SKILLED H&S PERSONNEL (8)	5.17
NEGLECT OF HUMAN RIGHTS AND MORAL VALUES (5)	5.44
BRIBERY AND CORRUPTION (1)	6.53
IGNORANCE OF THE BENEFITS OF COMPLIANCE (2)	6.15

Source: SPSS Output of the Study, 2020

Test Statistics <sup>a</sup>	
N	1190
Chi-Square	372.576
df	9
Asymp. Sig.	.000

a. Friedman Test

Source: SPSS Output of the Study, 2020

An SPSS Version 19 template was used to analyze the data gotten from respondents. From Table 7 above this ranked the Challenges to Health and Safety Compliance in South East, Nigeria. Bribery and corruption (with mean rank of 6.53) happens to be the highest challenge to Health and Safety Compliance. This is closely followed by Ignorance of the benefits of compliance, Lack of Health and Safety culture , Perception of stakeholders, Neglect of human rights and moral values , Non commitment of the major construction players, Inadequate training of staff and Lack of skilled Health and Safety personnel with mean ranks of 6.15, 5.73,5.59 ,5.44,5.33,5.28 and 5.17 respectively. It is also evident that Inadequate funding and Non-inclusion of Health and Safety in contract document & tendering process with mean ranks of 4.86 and 4.92 were the least constraint to Health and Safety Compliance in South East, Nigeria. Thus, bribery and corruption are the worst challenge while inadequate funding is the least of the challenges amongst professionals and stakeholders in the construction sub- sector.

The second panel of table 7 shows the various statistics with respect to Friedman’s Q test. The Chi-Square (more correctly referred to as Friedman’s Q) is our test statistic. It basically summarizes how differently the Challenges to Health and Safety Compliance were rated in a single number. The df are the degrees of freedom associated with our test statistic. It's equal to the number of variables we compared - 1. In our example, 10 variables - 1 = 9 degrees of freedom. The Asymp.

Sig. is an approximate p-value. Since  $p (.0000) < 0.05$ , we reject the null hypothesis of equal population distributions amongst the variables.

**Table 8: Chi-square cross tabulation of result and the compliance variables**

Variable	Chi-Square	P-Value	Level of Sig.	Remarks
HSP- HEALTH & SAFETY POLICY	60.781	0.000	Significant	Reject HO
HSA-HEALTH &SAFETY ADVISER	176.614	0.000	Significant	Reject HO
HST- HEALTH & SAFETY TRAINING	35.461	0.000	Significant	Reject HO
ALE-APPROPRIATE LIFTING EQUIPMENT	39.808	0.000	Significant	Reject HO
PPE-PERSONAL PROTECTIVE EQUIPMENT	177.987	0.000	Significant	Reject HO
FAF-FIRST AID FACILITIES	101.614	0.000	Significant	Reject HO
WSS-WARNING SIGNS AND SYMBOLS	82.213	0.000	Significant	Reject HO
RID-ROUTINE SAFETY INSPECTION &DRILLS	122.740	0.000	Significant	Reject HO
SWM-SAFE WORK METHODS	13.093	0.000	Significant	Reject HO
PTW-PERMIT TO WORK	84.564	0.000	Significant	Reject HO
AAO- ACQUAINTANCE &ADHERENCE TO OCCUPATIONAL SAFETY &HEALTH ACT	54.996	0.000	Significant	Reject HO

Source: Extracted from Cross Tabulation of State on Measures to Enhance Health and Safety Compliance SPSS Output of the Study, 2020

Table 8 above helps to ascertain the level of relationship existing between compliance level to health and safety regulations by construction firms in South East, Nigeria. Crosstabs and Chi-Square are powerful ways to analyze survey data with respect to association and relationships.

Thus table 8 showed all the variables used in measuring compliance level. It compared the P-value to the level significance. Usually, a significance level (denoted as  $\alpha$ ) of 0.05 is the rule of thumb. A significance level of 0.05 indicates a 5% risk concluding that an association between the variables exists when there is no actual association. Consequently in all the results of table 8 above, the P-values are 0.000. Since the P-values are less than (0.05) we conclude that all the measures of compliance level are associated with each other in South East Nigeria.



## CONCLUSION

The findings of this paper are as follows:

1. There is association in level of compliance in construction projects to existing Health and Safety regulations in South East Nigeria. This agrees with the findings of Umeokafor (2017) that there is a relationship between self-regulation and compliance with the law. This is because, firstly, enforced self-regulation can be a statutory requirement hence the need to comply with the law. Secondly, the concept of self-regulation including co-regulation is aimed at working with the regulated to develop, administer and control activities to achieve a desired established system -compliance.
2. The different Challenges to Health and Safety Compliance in South East Nigeria were identified as bribery and corruption (with mean rank of 6.53) happens to be the highest challenge to Health and Safety Compliance. This is followed by Ignorance of the benefits of compliance, Lack of Health and Safety culture , Perception of stakeholders, Neglect of human rights and moral values, Non commitment of the major construction players, Inadequate training of staff and Lack of skilled Health and Safety personnel, Non-inclusion of Health and Safety in contract document & tendering process and Inadequate funding. Thus inadequate funding is the least constraint while bribery and corruption is the greatest challenge to Health and Safety Compliance in South East, Nigeria. This corroborates Umeokafor (2017) findings that the factors influencing the self-regulation of construction H&S in Nigeria are categorized as primary or direct factors and secondary or indirect factors. The secondary factors are from the institutional, social, political and cultural environments. They include money, culture, insecurity, inadequate H&S policies, and multiple actors in H&S regulation, cultural institutions, political influence, social status and lack of governmental attention. He further posits that lots of Nigerians are living on below one dollar a day and unemployment level is high. The foregoing are reflected in the construction industry, as a lot in the industry are unskilled, walking straight from the streets to the industry; earning a living is their priority not H&S.
3. The research found out that there is significant relationship between health/safety regulations and enforcement of health and safety measures in South East Nigeria. Idoro (2011) also agrees that there is the need for effective risk management and regulation and control of OHS in the Nigerian construction industry.
4. There is significant positive relationship between health/safety regulations and Action plan for enhancing health safety measures in South East Nigeria. This corroborates the findings of Omobolanle and John (2017) that to promote an H&S culture that would provide continuous H&S performance improvement on construction projects, H&S legislation has to be specific, strictly monitored, and enforced.

## REFERENCES

- Cheung, S. O., Suen, H. C., & Cheung, K. K. A. (2004). A web-based construction project Performance monitoring system. *Automation in Construction*, Vol. 13, (2004) 361–376.
- Diugwu, I. A., Baba, D. L., & Egila, A. E. (2012). Effective Regulation and Level of Awareness: An Expose of the Nigeria's Construction Industry. *Open Journal of Safety Science and Technology*, 2,140-146.
- Dodo, M. (2014). The Application of health and safety plan in Nigeria construction firms. *Jordan Journal of Civil Engineering* 8(1)81-87
- Ezenwa, A. O. (2001). A Study of Fatal Injuries in Nigerian Factories. *Society of Occupational Medicine*, 51 (8), pp. 485-489.
- Idoro, G. I. (2011) "Comparing occupational health and safety (OHS) management efforts and performance of Nigerian construction contractors, "Journal of Construction in developing Countries", 16(2), 151-173.
- Idoro, G. I. (2008) Health and safety management efforts as correlates of performance in the Nigerian construction industry, "Journal of Civil Engineering and Management", 14(4), 277-285.
- Idubor, E. E., & Oisamoje, M. D. (2013). An Exploration of Health and Safety Management Issues in Nigeria's Effort to Industrialize, "European Scientific Journal", ESJ 9 (12).
- Ngwama, J. C. (2016). Framework for Occupational Health and Safety in Nigeria: The Implication for the Trade Union Movement. *Journal of Economics and Sustainable Development*. www.iiste.org ISSN 2222-1700 (Paper) ISSN 2222-2855 (Online) 7(1) 2016.
- Okoye, P. U., Ezeokonkwo, J. U., & Ezeokoli, F. O. (2016). Building Construction Workers' Health and Safety Knowledge and Compliance on Site. *Journal of Safety Engineering* P-ISSN: 2325-0003e-ISSN: 2325-0011 2016; 5(1): 17-26 doi: 10.5923/j.safety. 20160501
- Olutuase, S. O. (2014). A Study of Safety Management in Nigerian Construction Industry. *IOSR Journal of Business & Management (IOSR-JBM)* 16(3)01-10
- Omobolanle Adeyemo and John Smallwood (2017). Impact of Occupational Health and Safety Legislation on Performance Improvement in the Nigerian Construction Industry *Procedia Engineering* 196 (2017) 785 – 791
- Rantanen, J. (2005). Basic Occupational Health Services. *African Newsletter on Occupational Health and Safety*, 15(2), pp 34-37
- Umeokafor, N., Isaac, D., Jones, K., & Umeadi, B. (2014), Enforcement of Occupational Safety and Health Regulations in Nigeria: An Exploration. *European Scientific Journal* February 2014/Special/EDITION Vol. 3 ISSN: 1857- 7881(Print) e- ISSN 1857-7431
- Umeokafor, N., Umeadi, B., & Jones, K. (2014). Compliance with Occupational Safety and Health Regulations: A Review of Nigeria's Construction Industry <http://www.researchgate.net/publication/261711939>
- Umeokafor, N. I. (2017). Realities of Construction Health and Safety Regulation in Nigeria. PhD Dissertation, University of Greenwich 361
- Windapo, A. O., & Jegede, O. P. (2013). A Study of Health & Safety Practices of Nigerian Construction Companies. *Journal of the Professional Builder TPB*, 4(1)92-103



# EXAMINATION OF ENERGY CONSUMPTION REDUCTION MEASURES FOR RESIDENTIAL BUILDINGS IN TROPICAL CLIMATE: A CASE STUDY OF BIRNIN KEBBI, NIGERIA

Nkeleme Emmanuel Ifeanyichukwu<sup>1</sup>, Sani Abdulrahman Tolani<sup>2</sup>, Winston Shakantu<sup>3</sup> and Mbamali Ikemefuna<sup>4</sup>

<sup>1,3</sup>*Department of Construction Management, Faculty of Engineering, the Built Environment and Technology, Nelson Mandela University*

<sup>2</sup>*Department of Building Technology, Waziri Umaru Federal Polytechnic, Birnin Kebbi Nigeria*

<sup>4</sup>*Department of Building Technology, Ahmadu Bello University, Zaria, Nigeria*

Reducing energy consumption in the buildings sector is important and requires significant changes in terms of technology, human behavior, operation and management of the building in order to continue enjoying improved indoor environment without any prejudices on the environment. It is on the premises of this need that this study sought to examine the energy consumption reduction measures applicable to the tropical climate taking the Kebbi state as a case and with particular interest in residential buildings given that household consumption is one of the important factors of reducing energy consumption. It was effected using a structured questionnaire issued to occupant of the residential building (ranging from the less, medium and high energy consuming building benchmarking). Also, information on the energy consumed bills and consumption patterns of the household were collected and examined. Data collected were analyzed using the Statistical package for Social Science (SPSS) version 20 and the result presented using mean and Relative Importance Index (RII) for simplicity and to rank the severity of the energy reduction measures identified as opined by the respondents. The result revealed among others that: 'Consider lower energy consuming appliances, equipment when buying 'and 'the use of Daylight for reading and working in the building 'both (RII=0.8985) were ranked the most promising energy saving measure in the tropical climate. Other measures arranged in their order of viability are: 'keeping light and lighting fixtures clean '(RII=0.8955); and 'Switching off water heater, HVAC systems, pressing iron, and microwave after use '(RII=0.8895) among others. Consequently the Research recommends an orientation residential building occupants on measure that can improve the human behaviour in the use of energy such as paying attention on the energy label of appliances before purchase. Finally, the study recommends the adoption of automatic control system as it will help to curb human behavioural excesses

Keywords: behaviour, benchmark, energy consumption, reduction measure, residential building

<sup>1</sup> S224821946@mandela.ac.za

<sup>2</sup> tolaniabdulrahman@gmail.com; starsani@yahoo.com

<sup>3</sup> Winston.Shakantu@mandela.ac.za

<sup>4</sup> Mbamaikem@yahoo.com

## INTRODUCTION

Household consumption is one of the important factors to be considered in reducing energy consumption and its commensurate carbon dioxide (CO<sub>2</sub>) emission. Because its energy use may directly cause CO<sub>2</sub> emission. The enormity of Nigeria's energy problem creates a greater need for energy efficiency practice to be adopted by residential households as electricity demand in Nigeria far outstrips the supply which is epileptic in nature (Sule, Ajao, Ajimotokan, and Garba, 2011). On the other hand, because much energy is embodied in goods and services, consumption of living commodities and service may result in indirect CO<sub>2</sub> emission (Manzuma, et al. 2018). The income growth, improvement of living standard, the increasing amount of home appliance, housing and private transportation, have driven the indirect energy consumption and increased the amount of indirect CO<sub>2</sub> emission (Nwofe, 2014). Also, the International Energy Agency (IEA, 2011) estimated that, residential, public and commercial buildings account for 30 to 40 percent of the world's energy consumption and contributes 25 to 35 percent of the current world CO<sub>2</sub> emissions.

Growth in the use of a variety of electrical appliances is one factor contributing to the growth of energy use in buildings in recent decades. Therefore, Amann et al., (2007) identified that residential energy intensity, defined as energy use per square foot of living space, declined over the past 30 years in spite of the growing penetration of delivered energy (which is the electricity delivered to a site plus the fuels used directly onsite (e.g., natural gas for heating water). This measure does not account for the losses incurred in generating, transmitting and distributing the electricity.

The energy consumption reduction measures of a building are defined the United Nations Industrial Development Organization (UNIDO, 2006) as the extent to which the energy consumption per square meter of floor area of the building measures up to established energy consumption benchmarks for that particular type of building under defined climatic conditions. Sheila & Alicen, (2011) proposed that reducing existing building energy consumption in residential buildings lie in three synergistic approaches: to reduce energy requirements through implementation of energy efficiency measures in design stage, services design and retrofitting to offset the remaining building energy needs through the use of renewable energy system for existing buildings. It is however important to consider building energy consumption reduction measures before installing renewable energy reduction system, as the outlay cost to invest in energy consumption reduction measures is about half the cost of installing renewable energy generating capacity equal to what the energy reduction measures offsets (IEA, 200). Hence, investments in energy consumption reduction measures in residential buildings generally have much shorter pay-back times than energy supply investment; a particular important consideration in countries where the demand for supplies is growing rapidly (UNIDO, 2006). Africa's rate of urbanization of 3.5% per year is the highest in the world, resulting in more urban areas with bigger population proportional to the expansion of the existing urban areas; there are currently 40 cities in Africa with populations of more than a million; and it is expected that in a few years from now, 70 cities will have population of one million or more (UNIDO, 2006).

Globally, it has been shown that building sector consume more energy than any other sector; consuming about 42% of the world's total energy use. presently, energy consumption in the world is becoming greater and fossil fuels embody large shares to the overall energy use. Japan International Cooperation Agency (JICA, 2005) highlighted that, coupled with the concerned issue on future exhaustion of resources, global warming is also becoming a serious concern due to higher concentration of CO<sub>2</sub> emission in the air through the use of resources. Where electricity is intermittent in developing countries and power rotation is frequent, there is a large demand for diesel or petrol and renewable energy-based backup or standby power generation from end users (UNIDO, 2006). The Federal Ministry of Power Works and Housing FMPWH (2017) stated that reducing energy consumption requirement in buildings lessens the principal and running costs of these standby systems; thereby translating to energy consumption reduction, reduction in the cost of energy, profitability of business outlets, reduction in noise pollution and CO<sub>2</sub> emissions from buildings. Buildings could be emitting as much as 12, 600 tera-grams of CO<sub>2</sub> higher than what they are estimating at present if no proactive measures are taken to abate their energy demands (Forsstrom, Pekka, Esa, Miika, Jari, Kari and Irmeli, 2011).

It is in this view the research intent to assess measures that can be used to reduce energy consumption in residential building of Birnin Kebbi (12.43180N, 4.19560E) with a view to identifying areas of possible improvements in energy usage, using bench marking method.

## **LITERATURE REVIEW**

### **Energy consumption in residential buildings**

Worldwide, buildings consume massive amounts of energy. The United Nations Environment Programme (year) has reported that 30–40 percent of all primary energy produced worldwide is used in buildings. In 2008 the International Energy Agency released a publication that estimated that existing buildings are responsible for more than 40 percent of the world's total primary energy consumption and for 24 percent of global CO<sub>2</sub> emissions. it becomes paramount to examine energy consumption in the evolving built environment in a developing world context and pursue energy conscious measures in the short term, while advocating for a coherent and substantive policies as well as institutional frameworks on the long term. Lukić, Tamburić & Stojić, 2012 affirmed that Housing stock uses up to 40 % of total consumed energy which is significantly more than needed to provide comfort and function. Such wasting of energy significantly contributes to the greenhouse effect. For this reason, saving in energy consumption of the residential buildings can contribute to solving of the global problems such as the climate change and energy safety. Therefore, according to Janda, (2011) energy efficiency is perceived as the action of lowering energy demand by reducing ongoing energy usage. According to Nwofe (2014) energy efficiency in buildings is one of the fundamental steps towards reducing the agents/factors that could lead to global warming and climate change. It is a common knowledge that global warming is becoming more severe universally and poses very big risk to man. Hence, Hall (2010a) posited that buildings can incorporate many green features, but if they do not use energy efficiently, it is difficult to demonstrate that they are truly green. That is to say if a building is not

energy efficient, it cannot be said to be green. Although green buildings, on average, use less energy than conventional buildings, energy efficiency remains elusive. Numerous ways to improve a building's energy efficiency ranges from insulating walls to installing automatic shut off switches for lights. Energy efficiency can be and often is mandated by local and state energy codes, which require that new and substantially renovated buildings comply with increasingly stringent energy efficiency requirements. Lukić et al. (2012) observed that due to the high consumption of energy in buildings, and due to the highest potential for energy and environmental saving, energy efficiency is nowadays the priority of contemporary architecture and power industry. The measures for energy efficiency include: a series of directives and incentive mechanisms, mandatory energy certification of buildings, indicate the urgent need to reduce energy consumption in buildings, which results in a more comfortable dwelling in buildings, long service life of buildings, which in turn preserves the environment. The energy crises the country is facing coupled with population and infrastructural growth and the unrelenting rise of energy prices have stimulated research interest towards finding ways of alleviating or eliminating the unnecessary use of energy.

Oyedepo, (2012) stated that energy consumption reduction means improvement in practices and products that reduces the energy necessary to provide services like lighting, cooling, heating etc. These have endeared the principles of energy efficiency to the building occupants thus making it the key driver of sustainable development in many economies in the world. Furthermore, increasingly energy efficiency is considered to include not only the physical efficiency of technical equipment and facilities, but also the overall economic efficiency of the energy system. According to Hall 2010b, the energy performance of a building must be calculated using standards that indicate the insulation of the buildings, the characteristics of technical systems and installed equipment, the position and orientation of the building in relation to other climatic aspects, exposure, its own capacity for renewable energy sources and other factors, such as indoor environmental quality, that could influence the energy requirements of the building. Karolidis (2002) was of the opinion that the easiest and least expensive way of reducing operational costs in a building is to lower its energy consumption which is best done by increasing energy efficiency. There are great energy-cutting opportunities in simple designs that respond to location and climate. Green buildings are designed to save energy costs by reducing the energy consumption. Conventional (traditional) buildings consume more of the energy resources than necessary and generate a variety of emissions and waste.

### **Energy consumption reduction in residential buildings**

Reducing energy consumption in the buildings sector requires significant changes, but technology alone may fail to guarantee efficient energy performance. Human behavior plays a pivotal role in building design, operation, management and retrofit, and is a crucial positive factor for improving the indoor environment, while reducing energy use at low cost (Tianzhen Hong, Simona D'Oca et.al, 2015). Over the past 40 years, a substantial body of literature has explored the impacts of human behavior on building technologies and operation. The solution to overcome these problems will be to build them green and smart (Samer, 2013). One of the significant components in the concept of green buildings is using renewable energy. Solar energy and wind energy are intermittent sources of energy, so these

sources have to be combined with other sources of energy or storage devices where the variety of energy source and storage devices can be managed very well (Jiang, 2011). The attitude of residential building occupants in Nigeria shows that there is wide ignorance in use of switching off bulbs, appliances (Television, Computers, Microwave, Electric cooker, Water heater (ring), Electric kettle, Blender, Toaster, Oven, and Washing machine and the likes). The awareness on energy saving bulbs and appliance are limited to people in the urban areas while most rural areas are still using conventional bulbs (Tungsten/Yellow filament). Also, the price of a quality energy saving bulbs is still high and turning lights off when not in use would save a gigantic sum of 25,235,680,000 NGN (£55m) and 375000 tons of carbon (iv) oxide thereby preserving the environment and reducing energy cost simultaneously (Nwofe, 2014).

Although the majority of designers appreciate that the behavior of building users can affect energy performance, it is usually considered of little importance compared to engineering solutions to this issue (Janda, 2011). This is despite growing evidence to suggest that the impact of behavior can be extremely significant. Gill et al. (2010) investigated the impact of behavior on energy consumption at a BREEAM Excellent housing estate in the UK. Using a psychological model of planned actions, they discovered that deliberate energy efficient behaviors accounted for 51% and 31% of the variance in heating and electricity use respectively between homes. While the majority of studies on occupant behavior are limited to the domestic sector, Menezes et al. (2012) demonstrated that the level of control occupants believe they possess over lighting and appliances in a commercial office building also accounted for variations in electricity consumption of up to 17%. Traditional biomass fuels have been the single most important energy source in buildings for centuries. They still account for approximately 10% of global total primary energy use concentrated primarily in developing countries. Approximately 60% of all biomass is used in solid unprocessed forms such as firewood, agricultural waste, and dried animal dung burnt in crude and inefficient stoves and open fires for cooking and heating (IEA, 2008). Chronic Obstructive Pulmonary Diseases to which pollution from poor combustion of biofuels indoors contribute are predicted to become the world's third largest cause of death by 2030 (WHO Statistics, 2008).

### **Measuring energy use in buildings**

There are several approaches to reviewing the technologies and design principles available today to make buildings more energy-efficient. Each illuminates a subset of important engineering and physics issues but obscures other subsets. Each approach has its advantages and disadvantages. Therefore, this report does not adopt one preferred style of presentation but instead looks at three different approaches (ASHRAE, 2008). The three methods are:

1. An integrated whole-building or system-wide approach,
2. An approach by end-use and technology description, and
3. An approach by individual "widgets" or detailed energy consumption reduction technologies and measures.

### ***Integrated whole-building or system-wide approach***

The first approach looks at integrated whole-building or system-wide energy use and describes the types of technological improvements that could create savings of a given percentage for whole buildings or whole systems. For example, a small but growing subset of new commercial buildings achieve a savings of 50 percent (relative to prevailing model Energy Code ASHRAE 90.1) in regulated energy use (heating, cooling, air-conditioning, water heating, and lighting) (Amman, 2007). Reviews of highly efficient commercial buildings (NBI, 2008; ASHRAE, 2008; Torcellini et al., 2006) show that such buildings incorporate the following measures:

1. High-efficiency electrical lighting systems that not only incorporate state-of-the-art lamps, ballasts, and luminaires (lighting fixtures), but also use luminaires to provide the desired lighting in the right places (e.g., as task lighting) and use controls that limit electrical lighting when daylighting is available;
2. Fenestration systems and designs that reduce heat gain in climates with high cooling requirements;
3. HVAC controls that provide for the effective operation of the HVAC system during part-load conditions;
4. Regulated energy use refers to energy use covered by building energy codes. Such codes do not apply to plug-in office equipment, for example. There are many reasons why efficiency at part load can be lower. Examples range from systems that do not modulate but simply turn on or off, to chiller designs that are optimized for efficiency at full load and work poorly at part load (perhaps because they are not tested or marketed on the basis of such performance), to overall systems controls that continue to operate one part of the system at full-power use even though other parts are at partial power and do not require that support.
5. On-site power generation such as combined heat and power systems or solar photovoltaic generation to reduce purchased energy. Low-energy buildings do not always operate as they were designed to do. Experience shows that in order to maximize real-world energy savings, it is critical to properly commission and monitor the performance of low-energy buildings and to ensure that control systems are working properly and are adjusted to account for occupancy conditions (Torcellini et al., 2006; Mills, 2009). The net incremental first cost of achieving a 50 percent reduction in energy use through an integrated approach can be at or near zero; the savings from downsizing and simplifying HVAC systems generally pay fully for the additional costs of measures such as additional insulation, better windows, and daylighting (Goldstein, 2008). But the next increment of savings, up to 60 percent, has very few exemplars. For residential buildings, a whole-house energy management approach can result in a 50 percent or greater savings in heating and cooling and a 30–40 percent savings in total-home energy use, and also cost-effectively (DOE, 2004a; Dunn, 2007).
6. An integrated approach involves the design of the HVAC system with that of the envelope system and the lighting system and its controls. Current design practice involves designing the envelope of the building independent of such



integrative consideration, then passing the design onto HVAC engineers, who design the HVAC system without looking back at what could be done differently at the envelope or without looking forward to how lighting designs could enable improved HVAC designs.

***Approach by end-use and technology description***

Because whole-building studies focus on the level of savings achieved and the cost of getting there, they often do not specify the kinds of energy-saving measures used and how relevant they would be to broad-scale application across the economy. Instead, the savings estimates sometimes are based on measured results from demonstration buildings or multi building projects, or on case studies; they sometimes consider simulated energy savings based on integrated designs of new buildings or retrofits; and they sometimes are based on more than one approach. Other studies, however, rely on the end-use and technology description approach to identifying energy efficiency potential. This approach assigns energy use to major end-use categories and reviews the specific technologies and measures available for reducing energy use in each category (often ordered by cost-effectiveness). The end-use approach is based on text and explanation of technologies and measures. Most of these technologies and measures could be incorporated into existing buildings. As an example, space heating is the largest user of energy in residential buildings, and cooling is the second-largest or close to second-largest user. Similar energy-saving measures and strategies can be applied to both. These efficiency measures and strategies include the following (Scheckel, 2007; Amann et al., 2007)

Increasing insulation in all components compared with what is done according to current practice, including the use of selective coatings on windows. These coatings are chosen on the basis of the local climate, to reduce thermal transmission (by increasing the thermal-infrared emissivity and reflectivity of the window). They are most effective on west-and east-facing windows in climates requiring cooling or in transitional climates where an efficient shell can obviate the need to buy an air conditioner. Moving ducts into the conditioned space for new construction, and reducing leakage through on-site pressure testing in both new and existing homes. Improving heating and cooling systems themselves, for example, by using programmable thermostats, by using higher-efficiency furnaces that condense water vapor produced by the combustion of methane (or other fuels) to extract additional energy and achieve efficiencies over 90 percent, by using variable-speed and higher-efficiency motors and fans for air circulation, and by using ground-source heat pumps (for electric heating) or gas-fired heat pumps.

Upgrading equipment for cooling, focusing on better heat transfer from evaporators and condenser coils in air conditioners and employing variable-speed drives that allow units to operate efficiently at partial loads (rather than turning on and off frequently). This measure can control humidity more effectively, as well as save energy.

Changing ventilation systems to provide sufficient fresh air to a system that uses the proper amount of mechanical ventilation while sealing the home to nearly airtight standards. Controlling ventilation can greatly mitigate indoor air quality

and mold problems while also offering the opportunity to recover both latent and sensible heat from the exhaust airstream.

Using evaporative cooling. While once-through evaporative coolers work well only in desert climates, indirect systems that transfer sensible heat from the humidified airstream can provide comfort in a much broader zone of climate while using about one-quarter or less of the energy of compression-based cooling.

Making greater use of passive solar heating and cooling, although this design technique has not yet found widespread acceptance in the marketplace owing to the difficulties of custom designing the orientation and thermal characteristics of each home. After space heating and cooling, the next-largest user of energy in residences is water heating. Water-heating energy use can be reduced both by improving the efficiency of the water-heating device itself and by reducing the demands for hot water, including for clothes washing and bathing, throughout a home. Substantial gains have been made in the best-performing clothes washer and showerhead products compared with standard products. Heat-pump water heaters, which have become very popular in Japan, can reduce electricity use by two-thirds relative to an electric-resistance water heater. Older showerheads use 3.5 or more gallons per minute; newer ones meeting current standards use 2.5 or fewer gallons per minute, and a few newer models use about half this level of water flow to provide a comfortable shower (Harrod & Hain, 2007). Similar lists of technologies for residential lighting and appliances are found in most studies of efficiency potential. Beyond technologies themselves, efficiency can be improved through residential lighting design that raises the ratio of productive light output (lux on the visual task) to power use in homes to a level comparable to that in office buildings.

The major sources of energy use in commercial buildings are heating, ventilation, cooling, and lighting. Studies of energy efficiency potential usually look at specific measures within these categories, such as improving the rated efficiency of rooftop air conditioners by 20–30 percent or substituting 100 lumen per watt lamp-ballast combinations for existing product combinations that provide fewer than 70 lumens per watt.

### ***Energy benchmarking method***

Benchmarks are representative values for common building types against which a building's actual performance in terms of energy use can be measured. The benchmarks permit the comparison of the performance of a building to established standards to know whether or not the building's use of energy is efficient (Manzuma, 2020).

Chung, Hui and Lam (2006) describe energy benchmarking as a tool for enhancing the reduction or efficient use of energy in residential and office buildings. Also, Bloyd, Mixion and Sharp (1999) in their work shows that "benchmarking can be viewed as the first step in understanding and setting goals for energy consumption reduction improvements in buildings". Energy consumption reduction benchmarking can be seen as a tool used for monitoring changes in energy use, it also served as a basis for the design and retrofit in the budgeting for efficient energy use in efficient residential buildings (Lee, 1998 and 2004). However, energy benchmarking approach enable building owners understand the performance of

their buildings compared to similar buildings. Filippin (2000) in his work used a sample of energy consumption data and the floor area to calculate the Energy Use Intensity (EUI); for school buildings in central Argentina. The calculated EUIs were then ranked as a benchmark table and often used for judging the energy-use performance of a commercial building (Kinney and Piette, 2002). Therefore, energy saving potential by the method of benchmark can be classified as whole building metered approach or retrofit isolation approach.

### ***Whole building metered approach***

The whole building metered approach uses a main meter to measure the energy flow to the whole building (ASHRAE Guideline 14, 2002). Energy flow is usually electric, gas oil and thermal. These approaches involve the use of monthly utility bill data or data gathered more frequently from a main meter. The "whole building metered" approach, also called "main meter" approach encompasses procedures that verify the performance of the retrofits for those projects where the whole building pre- and post-retrofit data are available to determine the savings. Utility billing data (usually monthly data) are the basis of data analysis. Continuous measurements of the whole-building energy use before the retrofit and after the retrofit on a more detailed measurement level (weekly, daily or hourly) are also required (APEC, 2001). Consumption and demand values taken from sub-meters are acceptable for use under the whole building approach, where the meter measures energy use of a significant portion of the building area or a group of subsystems (e.g., motor control center). The data will have to meet all the requirements for a utility meter. Sub-meters are particularly useful in multiple building sites served by one utility meter (Energy Star, 2004). It is most appropriate to use a whole building metered approach when the total building energy performance is to be assessed, rather than the performance of specific retrofit (Energy Star, 2004). According to Cui (2006) there are two paths for the whole building approach with the respective criteria and requirements for its applicability, namely, the whole building prescriptive path and the whole building performance path. The former one is most appropriate when the expected savings are greater than 10% of the measured energy use or demand and when the data are continuous and complete with no data points to be excluded, and are expected to remain this way in the post-retrofit period.

## **METHODOLOGY**

### **Research design**

This study was conducted through field survey. The field work of this research was conducted using various research instruments, each adopted to meet a particular research need. The work involves the collection of quantitative data through energy benchmarking, and the use of a well-structured questionnaire as the instrument for primary data collection. The survey yielded data from the meter energy bills and on the energy consumption patterns of the household.

### **The study area**

The research was conducted in Kebbi State (11.49420 N, 4.23330 E) in the northwestern part of Nigeria. It has a tropical continental-type climate with a wet season that lasts from April to October in the south and from May to September in the north—the dry season lasts for the remaining period of the year. The

temperature is generally high with a mean annual temperature of about 26°C in all locations. But during the harmattan season (December to February) the temperature can go as low as about 21°C; between April and June, it can rise as high as 40°C (Bello & Jeb, 2014).

The State was created out of a part of Sokoto State on 27th August, 1991. Kebbi State is bordered by Sokoto State to the North, Niger State to the South, Zamfara State to the East. Dosso region in the Republic of Niger to the West and Benin republic to the Southwest (Mukhtar, 2016).

### Data collection

Firstly, questionnaires were distributed and data collected used to categorize the households into low, average and high energy consumption respectively. A more detailed examination of selected houses in each category furnished some peculiar energy use behaviors and consequently measures through which energy use can be reduced were identified. Energy benchmarking approach enables building owners understand the performance of energy consumption of their building compared to similar buildings. In this case, an examination of the actual investigated residential buildings, including a visual inspection of each of the associated equipment in the selected houses, dimension of space and energy measurements were carried out. Historical data of purchased energy were reviewed to identify patterns of electrical energy usage and compare them with distribution company average benchmark. The energy benchmark for a two-bed room building measuring 95M<sup>2</sup> to 120M<sup>2</sup> in Birnin Kebbi range between 200KWh and 250KWh while for three bed room measuring 121M<sup>2</sup> to 145M<sup>2</sup>, it ranges between 300KWh – 350KWh monthly with eighteen hours (18hrs) daily of electric energy supply (KEDCO, 2019).

### Data analysis

Responses from the questionnaires survey were analyzed using a computer-based software called Statistical Product and Service Solutions (SPSS) IBM version 20 and results were presented as percentages. Relative importance index (RII) was used to identify area of energy wastage and its reduction measures, which when implemented will make the energy usage more efficient, less expensive and more environmentally friendly.

The weighted average for each item was determined and ranks were assigned to each item, representing the perception of the respondents

$$\text{Relative Importance Index (RII)} = \frac{\sum fx}{\sum f} \times \frac{1}{k} \dots\dots\dots (1)$$

Where,

$\sum fx$  = is the total weight given to each attributes by the respondents.

$\sum f$  = is the total number or respondents in the sample.

K = is the highest weight on the likert scale.

Results are classified into three categories as follows (Othman et al, 2005) when;

$RII < 0.60$  -it indicates low frequency in use

$0.60 \leq RII < 0.80$  -it indicates high frequency in use.

$RII \geq 0.80$  -it indicates very high frequency in use.

## FINDINGS AND DISCUSSION

### Demographic information on sampled buildings

From the result presented in Table 1, nine (9) of the buildings falls under less energy consuming building (LECB) with an average energy consumption of 2640KWh (year), Twenty one of the buildings falls under the more energy consuming building (MECB) with an average energy consumption 3840KWh (year) and the remaining Thirty seven buildings falls under high energy consuming building (HECB) with an average energy consumption of 4680HWh (year) forming the population of the study are in Birnin – Kebbi (KEDCO, 2019).

The table show the number of building under each category of energy consumptions from energy billin company, nine of the residential buildings were the LECB, which represented 13.43% of the studied residential buildings; twenty one(21) were in the category MECB representing 31.34% of the residential houses surveyed while thirty seven (37) residential buildings were in the category of HECB, which represented 55.22% of the studied residential buildings

**Table 1 Categories of residential buildings to benchmark**

S/ N	Building Categories	Energy consumption from the Bills (KWH/year)	Number of Buildings assessed	Percentage (%)
1	less energy consuming building (LECB)	0-2640	9	13.43
2	more energy consuming building (MECB)	2641-3840	21	31.34
3	high energy consuming building (HECB)	3641-4680	37	55.22
Total			67	100

Source: Field Survey, (2019)

Table 2, show a comparative examination of the energy consumption of the billing company, the benchmarked energy consumption and the actual energy consumption. From the Table it can be discovered that the LECD used less energy compared to the benchmarks, indicating consumption reduction use of energy in these buildings, most of the MECD building used more energy than the benchmarks and the remaining. Similarly, most of the HECB buildings used high energy compared to the benchmarks, indicating inefficient use of energy in the residential buildings

However, the estimations from the energy audits show that all the buildings were energy efficient. This implies that all the buildings including those that were energy-efficient from the bills can be operated on lower quantities of energy if some measures aimed at avoiding wasteful use of energy are adopted. The variations in the quantity of energy between consumptions from energy bills and

estimates from the audit could be as a result of differences in actual durations of use of appliances and the durations used in the estimations, weather conditions, behaviour of end-users and poor energy efficiency and management practices.

It will also be observed from Table 2 that the differences in consumption from the bills and the audits were quite large. The implication of this is that the occupants in the residential buildings will be able to significantly reduce their expenditure on energy if some of the assumptions used for the audits are adopted.

**Table 2 Comparison of the energy use (KWh/year) in the residential buildings to benchmark**

Buildings	Consumption from Bills	Consumption from Audit	Benchmarks	Difference From Bill (%)	Difference From audit (%)
LECB	2640	1200	3000	-12%	-60%
MECB	3840	1800	3600	6.67%	-50%
HECB	4680	2400	4200	11.43%	43%

Source: Field Survey, (2019)

### Ranking of energy consumption reduction measures

The occupants in the buildings studied ranked their opinion willingness to embrace the possible energy consumption reduction measures identified and the result of the analysis is as presented in the Table 3.

The respondents willingly agree with the finding on the human behaviour to reduction of energy consumption in residential building in Birnin Kebbi, Kebbi State Nigeria. Buying lower energy consuming appliances with RII of 0.8985, Daylight for reading and working in the building with RII of 0.8985, Keep light and lighting fixtures clean with RII of 0.8955, Switch off water heater, pressing iron, microwave after use with RII of 0.8895, Switch off and remove TVs, Computers... plugs when not in use with RII of 0.8805, Ensure all openings are air tight during cooling with RII of 0.8805, Unplug all power loads when not in use with RII of 0.8716, Lighter colour paint on walls and ceiling reduce heat emission with RII of 0.8567, Replace all incandescent bulbs with energy saving types with RII of 0.8507, Clean the reflectors underneath the burners on the stove tops with RII of 0.8388, Reduce heat gain by planting trees and flowers around the building with RII of 0.8268, Turning off light and appliances when not in use with RII of 0.8179, Fill the freezer by ensuring efficient usage of the space with RII of 0.8089, Switching from electrical to solar water heating with RII of 0.8059, Switching from the conventional roofing system to cool roofs with RII of 0.8029, Installation of renewable energy technologies with RII of 0.8029, Use occupancy sensors controls switches for lighting with RII of 0.8000 and Ensure food is cooled before it goes in to the refrigerator with RII of 0.7850 were ranked first, second, third, fourth, fifth, sixth, seventh, eighth, ninth, tenth, eleventh, twelfth, thirteenth, fourteenth, fifteenth, sixteenth, seventeenth and eighteenth respectively are considered very significant factor because their relative significant index is above 0.76. why replacing appliances over ten years old with reduce energy consuming once with RII of 0.7582 and clean cooling coils on a regular basis for efficiency with RII of 0.7164 was ranked nineteenth and twentieth respectively and were considered significant factor between the range of significant index of 0. 67 – 0.75.

**Table 3 Building occupants willingness to embrace energy consumption reduction measures**

S/N	Energy Consumption Reduction Measures	WEIGHTING/RESPONSE FREQUENCY							Mean	RII	Rank
		1	2	3	4	5	( $\Sigma f$ )	$\Sigma fx$			
1	Consider lower energy consuming appliances, equipment when buying?	0	0	0	34	33	67	301	4.4925	0.8985	1
2	Daylight for reading and working in the building	0	0	3	28	36	67	301	4.4925	0.8985	1
3	Keep light and lighting fixtures clean	1	1	2	24	39	67	300	4.4776	0.8955	3
4	Switch off water heater, pressing iron, microwave... after use	0	0	0	37	30	67	298	4.4478	0.8895	4
5	Switch off and remove TVs, Computers... plugs when not in use	1	1	0	33	32	67	295	4.403	0.8805	5
6	Ensure all openings are air tight during cooling	0	1	1	35	30	67	295	4.403	0.8805	5
7	Unplug all power loads when not in use	0	0	4	35	28	67	292	4.3582	0.8716	7
8	Lighter colour paint on walls and ceiling reduce heat emission	1	2	9	20	35	67	287	4.2836	0.8567	8
9	Replace all incandescent bulbs with energy saving types	1	2	12	16	36	67	285	4.2537	0.8507	9
10	Clean the reflectors underneath the burners on the stove tops	0	0	8	38	21	67	281	4.194	0.8388	10
11	Reduce heat gain by planting trees and flowers around the building	0	4	12	22	29	67	277	4.1343	0.8268	11
12	Turning off light and appliances when not in use	3	7	7	14	36	67	274	4.0896	0.8179	12
13	Fill the freezer by ensuring efficient usage of the space	1	1	7	43	15	67	271	4.0448	0.8089	13
14	Switching from electrical to solar water heating		2	15	29	21	67	270	4.0299	0.8059	14
15	Switching from the conventional roofing system to cool roofs	2	3	11	27	24	67	269	4.0149	0.8029	15
16	Installation of renewable energy technologies	0	3	13	31	20	67	269	4.0149	0.8029	15
17	Use occupancy sensors controls switches for lighting	2	3	10	30	22	67	268	4.0000	0.8000	17
18	Ensure food is cooled before it goes in to the refrigerator	2	6	9	28	22	67	263	3.9254	0.7850	18
19	Replace appliances over ten years old with reduce energy consuming once	2	6	17	21	21	67	254	3.7910	0.7582	19
20	Clean cooling coils on a regular basis for efficiency	5	15	6	18	23	67	240	3.5821	0.7164	20

Source: Field Survey (2019).

Where: (1 = Very Unwilling, 2 = Unwilling, 3 = Fairly Willing, 4 = Willing, 5 = Highly Willing)

From the findings on human behaviour to reducing energy consumption in residential building, it can be deduced that buying lower energy consuming appliances, daylight for reading, working, clean lighting fixtures, switch off and unplug all power loads when not in use, finally, using lighter colour paint on walls and ceiling reduce heat emission were found to be the most difficult challenges in human behaviour bedevilling the reduction of energy consumption in residential building in Birnin Kebbi, Kebbi State Nigeria. This deduction tallies with that of Howe (2011), Keith & Cassie (2009), Oyedepo (2012) and Samer (2013).

## **RECOMMENDATIONS AND SUGGESTIONS ON ENERGY SAVING MEASURES**

93.05% of the respondents suggest other means or measures and state government role in ensuring that respondent can adopt to reduce energy use in residential building, only 50.00% of them suggested four (4) ways to reduce energy consumption in residential building are: 16.67% of the respondent suggested that the government should regulate through its agency the importation and local manufacturing of sub-standard electrical appliances, 9.90% of the respondent recommended the use of automatic control system to reduce energy consumption, 20.00% of the respondent believe that all building should be provided, installed and protected prepaid meter in an open save place, finally 8.43% of the respondent suggested alternative source of energy (solar, wind turbine, bio gas) as different ways of reducing energy consumption in Gesse Housing Estate phase (1 & 2) Birnin Kebbi area of Kebbi State Nigeria.

On the state government having a role to play in ensuring energy consumption reduction to avoid the consequences of energy wastages, 38.05% of the respondents suggested that providing policies, regulations and sensitisation of the people to ensure efficient response, enforcement and implementation. The result tally with (Sovacool et al., 2015) are therefore, currently been geared towards reducing energy consumption due to the global problem of insufficient energy.

## **CONCLUSION**

From the data gathered and analysed by the researcher and the major research finding above, the researcher drew the following conclusions:

- a. Less than half of the sampled residential buildings had no formal policy for reducing energy consumption.
- b. Most of the building users don't check energy label before buying energy consuming appliances.
- c. The most selection options by building users in Nigeria is government policies.
- d. The major challenges against successful implementation of reduced energy consumption in residential building are both building design and implementation.
- e. The building services design have a lot of impact on the performance of energy consumption reduction measures in the Nigerian residential buildings.

Conclusively, for residential building in Nigeria to continue to maintain competitive advantage of reduced energy consumption, they must embrace innovative and pragmatic approaches in their building services design and selection of automatic control system.



## RECOMMENDATIONS

The importance of the reduction of energy consumption in residential building in Birnin Kebbi, Kebbi State Nigeria, practices cannot be over-emphasised. Therefore, the following recommendations as drawn from the conclusions above must be well noted.

- a. For residential building to successfully achieve reduced energy consumption they must have in place building services designed policies to guide in giving approvals for building construction in Nigeria.
- b. Certified professionals have to check and recheck building services design before any approval of building design will be adopted,
- c. The building owners and residents needs to have a full knowledge of the building they are residing, this will enable them to fix up the specific duties and responsibilities of every appliance in their facility.
- d. The state government should try and eliminate estimated billing and prove all residential building with meter to reduce over billing to the barest minimum.

## REFERENCES

- Adekunle, A. U., Manzuma, M. B. & Stanley, A. M. (2020). Assessment of Energy Efficiency of Customer Care Buildings of Telecommunications Companies in Selected Towns in Nigeria. *Built Environment Journal* Vol. 17, No 1, 2020, pg 1-16.
- Amann, J. T., Wilson, A. & Ackerly, K. (2007). *Consumer Guide to Home Energy Savings*. 9th Edition. Washington, D.C.: American Council for an Energy-Efficient Economy.
- APEC (1999). APEC Benchmarking System. Asia Pacific Economic Cooperation. Retrieved from <http://eber.ed.ornl.gov/apec/index.htm>.
- APEC (2005). APEC energy overview 2005. Asia Pacific Energy Research Centre, Asia. Pacific Economic Cooperation. Retrieved from [www.apec.org](http://www.apec.org).
- ASHRAE. (2002). ASHRAE Guideline 14-2002: Measurements of energy and demand savings. American Society of Heating refrigeration, and Air-conditioning Engineers, Inc., Atlanta, G.A
- ASHRAE. (2002). ASHRAE Guideline 14-2002: Measurements of energy and Asia-Pacific Economic Cooperation Energy Benchmark System.
- Bello, M. N., & Jeb, D. N. (2014); Analysis of flood risk inundation hazard in Birnin Kebbi town, Kebbi state, Nigeria: *International Journal Of Geomatics And Geosciences* Vol. 5, No 1, ISSN, (0976 – 4380), pub on August 2014, pg 119.
- Bilie, G. S. (2012); *Green Building Elements; Renewable Energy and Energy Efficiency for Tribal Community Development*, Forest County Potawatomi Bingo & Casino Milwaukee, MN.
- BizEE Software Limited (2015); *The What, Why, and How of Energy Management*.
- Bloyd, C. N., Mixion, W. R., & Sharp, T. (1999) Institutionalization of a benchmarking system for data on the energy use in commercial and industrial buildings. Project Report. Asia Pacific Economic Cooperation.

- Boyano, A., Hernandez, P., & Wolf, O. (2013). Energy demands and potential savings in European office buildings: Case studies based on EnergyPlus simulations. *Energy and Buildings*, 65, 19-28.
- Chung, W., Hui, Y. V., & Lam, M. Y. (2006). Benchmarking the Energy Efficiency of Commercial Buildings. *Applied Energy*.
- Cochran, W. G. (1998) COMPARISON OF METHODS FOR DETERMINING Stratum Boundaries. *Bull. Int. Stat Inst*, 38, 2, 345-358
- Colmenar Santos, A., Delober, L., Borge Diez, D., & Castro Gil, M. (2013) Solutions to reduce energy consumption in the management of large buildings. *Energy And Buildings*.56,66.
- CREDC [Center for Renewable Energy Development Commission] (2007). "Promoting renewable energy and energy efficiency in Nigeria",
- Crossley, D. M., Maloney, & G. Watt, (2000). Developing mechanisms for promoting demand side management and energy efficiency in changing electricity businesses. Hornsby Heights, Task VI of the IEA Demand-Side Management Program
- Daly, H. E., (1973). "Towards a Steady State Economy". San Francisco: Freeman
- DanShehu, B. G., Asere, A. A., & Sambo A. S. (2006). Development of community -based solar water heating system. *Nigeria Journal of Solar Energy*. 16, 106.
- DOE (2003) Commercial Buildings Energy Consumption Survey (CBECS). U.S. Energy Information Administration. Retrieved from <https://catalog.data.gov/dataset/commercial-buildings-energyconsumption-survey>
- DOE (2011): A Guide to Energy Audits. U.S. Energy Information Administration. Retrieved from [http://www.pnnl.gov/main/publications/external/technical\\_reports/pnnl-20956.pdf](http://www.pnnl.gov/main/publications/external/technical_reports/pnnl-20956.pdf)
- ECN, (2009). "ECN-NYSC Renewable Energy Training Manual", ECN Abuja.
- ECN, (2009). "ECN Project Report' "Study for the development of energy balance for Nigeria',
- Eguaras-Martínez, M., Vidaurre-Arbizu, M., & Martín-Gómez, C. (2014): Simulation and evaluation of building information modeling in a real pilot site. *Apple Energy* 114:475-484. This study includes occupant behavior in building simulations to demonstrate up to 30% difference when comparing with a real pilot study.
- EIA (2010). Annual Energy Outlook with Projections to 2035. Retrieved from <http://www.eia.gov/oiaf/aeo/pdf/0383> (2010).pdf
- EIA (2012). Use of energy in the US explained: Energy use in commercial buildings. Retrieved from [https://www.eia.gov/energyexplained/index.php?page=us\\_energy\\_commercial#ta2](https://www.eia.gov/energyexplained/index.php?page=us_energy_commercial#ta2)
- Energy efficiency in the workplace (1994)— a guide for managers and staff Good Practice Guide GPG 133 (Action Energy).
- Energy Star. (2004). Available from <http://www.energystar.gov>
- Federal Ministry of environment, Nature conservation and Nuclear safety, BMU (29-30)
- Filippin, C. (2000). Benchmarking the Energy Efficiency and Greenhouse-Gases Emissions of Buildings in Central Argentina. A Paper presented at the International Conference on Improving Energy Efficiency in Argentina.

- FMPW&H (2016). Building Energy Efficiency Guideline for Nigeria. Retrieved from
- Geissler, S., Österreicher, D. & Macharm, E. (2018). Transition towards Energy Efficiency: Developing the Nigerian Building Energy Efficiency code. Retrieved from <http://www.mdpi.com/2071-1050/10/8/2620/pdf>
- Geller, H. P., Harrington, A. H., Rosenfeld, S., Tanishima & Unander, F. (2006). "Policies for increasing energy efficiencies.30 years of experience in OECD countries". Energy Policy. 34 (5): 556-573.
- Gunay, H. B., O'Brien, W., & Beausoleil-Morrison, I. (2013): A critical review of observation studies, modeling, and simulation of adaptive occupant behaviors in offices. Build Environ, 70: 31–47. This paper provides a review of occupant behaviors in offices.
- Hall, M (2010a); Materials for Energy Efficiency & Thermal Comfort in Buildings. Woodhead Publishing Limited.
- Hall, S. (2010b) Assessment of the Performance of Green Commercial Buildings: A Sustainable Built Environment National Research Centre Literature Review, Curtin University and Queensland University of Technology.
- Harrod, J., & L. Hain. (2007). Showerheads! Home Energy. November/December, pp. 40-41.
- Henrik N. (2013) Knudsen Danish Building Research Institute, Aalborg University.
- Hoes, P., Hensen, J. L. M., Loomans, M. G. L. C., de Vries, B. D. Bourgeois (2009): User behavior in whole building simulation. Energy Build, 41:295–302. [https://energypedia.info/images/c/c7/Building\\_Energy\\_Efficiency\\_Guideline\\_for\\_Nigeria\\_2016.pdf](https://energypedia.info/images/c/c7/Building_Energy_Efficiency_Guideline_for_Nigeria_2016.pdf)
- IEA. 2007. Mind the Gap: Quantifying Principal-Agent Problems in Energy Efficiency. Paris, France: IEA.
- IEA.2011. CO2 Emissions from Fuel Combustion. Retrieved from <http://www.iea.org/termsandconditionsusecopyright>
- IPCC, 2007a: Climate Change 2007: Synthesis Report. Contribution of Working Groups I, II and III to the Fourth Assessment Report of the Intergovernmental Panel on Climate Change [Core Writing Team, Pachauri, R.K and Reisinger, A.(eds.)]. IPCC, Geneva, Switzerland, 104 pp.
- Iqbal, I. & Al-Homoud, M. S. (2007). Parametric analysis of alternative energy conservation measures in an office building in hot and humid climate. Building & Environment, 42, 2166 2177
- Janda, K. (2011) Buildings don't use energy: People do. Architectural Science Review, 54, 15-22.
- KEDCO, (2019). Energy purchased data for residential building customer, Kaduna Electricity Distribution Company.
- Kinney, S., & Piette, M. A., (2002). Development of California Commercial-Building Energy Benchmarking Database. In: ACEEE 2002 Summer Study on Energy Efficiency in Buildings. California, United States.
- Kneifel, J. (2010). Life cycle carbon and cost analysis of energy efficiency measures in new commercial buildings. Energy and Buildings, 42, 333 340.
- Lee, S. E. (1998). An Integrated Building Environmental Assessment Using Total Building Performance Approach. (Research Project No: RP 972051) National University of Singapore, Faculty of Architecture, Building & Real Estate. Singapore.

- Lee, S. E. (2004). Performance Benchmarking and Enhanced Energy Efficiency of Buildings, Paper presented at the International Congress on Architecture and Technology, Frankfurt, Germany.
- Lee, W. L. & Yik, F. W. H. (2004). Regulatory and voluntary approaches for enhancing building energy efficiency. *Progress in Energy and Combustion Science*, 30, 477-499.
- Levine, M., Urge-Vorsatz, D., Blok, K., Geng, L., Harvey, D., L and, S., Levermore, G., Mongameli Mehlwana, A., Mirasgedis, S., Novikova, A., Rilling, J., Yoshino, H., (2007), Residential and commercial buildings, *Climate Change 2007*
- Lukić, P; Tamburić, J; Stojić, D (2012); Energy Efficiency of Buildings with Phase-Change Materials; Series: Architecture and Civil Engineering, Vol. 10, No 3, 2012, pp. 343 – 352.
- Managing and motivating staff to save energy Good Practice Guide GPG 84 (Action Energy) (1993) ([www.actionenergy.org.uk](http://www.actionenergy.org.uk)).
- Manzuma, B. M., Mbamali, I., Stanley, M. A., & Sani, M. (2018); Carbon Dioxide Emissions From Use And Mitigation Potential Of Household Behavioural Modifications In Kaduna Metropolis, Nigeria: *Journal of Design and Built Environment*, Vol. 18(1), 2018, pp 1–8.
- NBI (New Buildings Institute). 2008. Getting to Fifty Web site. White Salmon, Wash.: NBI. Available at <http://www.newbuildings.org/gtf>.
- Oforeh, E. C. (2008): Installation and measurement of Electric Works in Building. Third Edition, Cosines Nig Ltd Lagos.
- Ogbuagu J. O, Ajiwe V. I. E, Aboatu A. N. "Solar Energy Applications for Sustainable Development in Nigeria". A review: *Nigeria Journal of Renewable Energy*, (2001), Vol 9, Nos 182, pp
- Parker, D., Mills, E. Rainer, L., Bourassa, N. & Homan G. (2012): Accuracy of the home energy saver energy calculation methodology, in: ACEEE Summer Study on Energy Efficiency in Buildings. (12–206 to 12–222).
- Popescu, D., Bienert, S., Schützenhofer, C. & Boazu, R. (2012). Impact of energy efficiency measures on the economic value of buildings. *Applied Energy*, 89, 454-463
- Ruparathna, R., Hewage, K., & Sadiq, R. (2016). Improving the energy efficiency of the existing building stock: A critical review of commercial and institutional buildings. *Renewable and Sustainable Energy Reviews*, 53, 1032-1045
- Sambo A. S. "Study for Development of Energy Balance for Nigeria", Nigeria, (2009).
- Samer, M. (2013); Towards the implementation of the Green Building concept in agricultural buildings: a literature review. *Agric Eng Int: CIGR Journal*, 15(2): 25–46.
- SECCP "Getting to Grips with Sustainable Energy". Publication of the Sustainable Energy and Climate Change Partnership (SECCP), (2002).
- Sharp, T. R. (1996). Energy Benchmarking in commercial buildings.
- Sharp, T. R. (1998). Benchmarking Energy Use in Schools. Proceedings of ACEEE Simulation for Building Design and Evaluation: The Singapore Perspective. Standardization, Geneva, Switzerland.

- Sovacoo, B. K. (2014),. What are we doing here? Analyzing fifteen years of energy scholarship and proposing a social science research agenda. *Energy Res SocSci* 1:1–29. This paper emphasizes the need for integrating social science methods and techniques into energy related research.
- Sovacool, B. K., Ryan, S. E., Stern, P. C., Janda, K., Rochlin, G., Spreng, D., Pasqualetti, M. J., Wilhite, H., & Lutzenhiser L., (2015). Integrating social science in energy research. *Energy Res Soc Sci* 6:95–99. This paper provides a perspective of the energy studies field from a social science vantage and provides recommendations for better interdisciplinary work with engineering and sciences.
- Sule, B. F., Ajao, R. K., Ajimotokan, A. H., & Garba, M. K. (2011). Compact Fluorescent Lamps and Electricity Consumption Trend in Residential Buildings in Ilorin, Nigeria, *International Journal of Energy sector Management*,5 (2): 162-168, Emerald Group Publishing Limited, UK
- Sylvie B. "Who benefits from sustainable development?" France, (2008).
- The Chartered Institution of Building Services Engineers London; Second edition January 2004 ISBN 1 903287 34 0.
- Torcellini, P., S. Pless, M. Deru, B. Griffith, N. Long, & R. Judkoff. (2006). Lessons Learned from Case Studies of Six High-Performance Buildings. NREL/TP-550-37542. Golden, Colo.: National Renewable Energy Laboratory. June.
- Turner, C., Frankel, M., (2008). U. G. B. Council, Energy Performance of LEED for New Construction Buildings, New Buildings Institute, Vancouver, WA.
- Uihlein, A. & Eder, P. (2010). Policy options towards an energy efficient residential building stock in the EU-27. *Energy and Buildings*, 42, 791-798
- UNIDO (2006), Sustainable Energy Regulation and Policy Making for Africa. Retrieved from [https://www.unido.org/fileadmin/user\\_media/Publications/Pub\\_free/training\\_manual\\_ofsustainable\\_energy\\_regulation\\_and\\_policymaking\\_for\\_Africa.pdf](https://www.unido.org/fileadmin/user_media/Publications/Pub_free/training_manual_ofsustainable_energy_regulation_and_policymaking_for_Africa.pdf)
- UNIDO (2009). Sustainable energy regulation and policymaking for Africa. Retrieved from [https://www.unido.org/sites/default/files/2009-02/Module18\\_0.pdf](https://www.unido.org/sites/default/files/2009-02/Module18_0.pdf)
- US Dept. of Energy, "Annual Energy Report" Energy Flow diagram, (July 2006).
- Yamane, T. (1967). *Statistics, An Introductory Analysis* (2nd Ed). New York: Harper and Row.



---

# FACTORS AFFECTING THE DELIVERY OF BUILDING CONSTRUCTION PROJECTS FUNDED BY DISTRICT ASSEMBLIES COMMON FUND (DACF): THE CASE OF SELECTED REGIONS IN GHANA

Aborah-Osei Castro<sup>1</sup> and Humphrey Danso<sup>2</sup>

<sup>1,2</sup>*Department of Construction and Wood Technology Education, Akenten Appiah-Menka University of Skills Training & Entrepreneurial Development, Kumasi-Ghana*

Work delivery has been one of the effective avenues for appreciating value for money in this current economic situation, especially in the construction industry. Metropolitan, Municipal and District Assemblies (MMDA's) are mandated by legislative and executive functions to also develop local infrastructure. This, thus prompted for the introduction of District Assemblies Common Fund (DACF) as one of the major funding sources for infrastructure project delivery at the various MMDA's. However, the recognition of DACF by the MMDA's in this respect on construction project delivery over the years seems to have been stifled as priority has been given to other sectors other than how these projects should be delivered. The study sought to investigate the factors affecting the delivery of building construction projects funded by DACF. This was achieved by employing a cross-sectional survey in the design from participants in Ashanti, Greater Accra, and Bono East regions in Ghana. The outcome of the study revealed that contractor, project funding, supply chain, site, and client related factors are the 5 main factors affecting the delivery of building construction projects. The findings again identified 7 major effects of these factors; which were cost and time overrun, poor quality standard work, unexploited completed project, contractor bankruptcy or liquidation, accident/disaster, loss of workers, and profit and loss of stakeholders 'trust and confidence. It was concluded that MMDA's building construction project delivery funded by DACF efficiency stands a chance to be improved. It is therefore recommended for the Ministry of Local Government and Rural Development (MLGRD) to review DACF guidelines for utilisation and introduce a project charter in MMDA's building construction project delivery.

Keywords: building construction industry, District Assemblies Common Fund (DACF), Metropolitan Municipal and District Assemblies (MMDA's), project delivery

## INTRODUCTION

Work delivery has been one of the effective avenues of realizing value for money in all spheres of life especially in the manufacturing and service provision industry;

---

<sup>1</sup> castos1985@gmail.com

<sup>2</sup> hdanso@aamusted.edu.gh

and for that matter the work delivered must be of good quality (Tausef, 2012). As a contributor to national socio-economic development and a source of foreign direct investment, the construction industry stands better as such realization and impact from its emerging outcomes are greatly felt especially when the entire process is well delivered (Ofori, 2012). According to Basheka and Tumutegereize (2011) in Kissi et al (2018) the construction industry accounts for a significant portion of the world's Gross Domestic Product (GDP); this, revealed in the report of the Ghana Statistical Service that, between 1st and 3rd quarter of 2020, the construction industry contributed 3.6% to GDP of Ghana. This hypothesized that the construction sector provides a substantial source of direct and indirect employment to majority of the citizens all over the country. Delivering such construction projects many a time is inhibited by a series of drawbacks which impedes its original intent eventually. To this, the study sought to identify these underlying challenges affecting the delivery of building construction projects funded by the DACF in some selected regions of Ghana.

The DACF as established under article 252 of the 1992 Constitution of Ghana confers the purpose of the promotion of local-level development. According to Robinson (2015), the DACF presently presents a major channel for government development assistance, especially to the districts. There is evidence from all over the country that the Common Fund has since its inception been the primary source of project funding in the Metropolitan, Municipal, and District Assemblies (MMDA's) over the last 20 years others (District Assembly Common Fund home page, 2008). In this light, the Common Fund has been the pillar of a vast range of projects including physical infrastructure and human resource development at the district level. Also, the Common Fund has assisted in the implementation of various projects in the MMDA's, focusing on priority areas such as education, health care delivery, portable water supply, market infrastructure, sanitation, roads and drains construction among others (District Assembly Common Fund home page, 2008).

Despite the recognition of DACF needs and appreciation; and the national agenda towards the improvement of the nation's development through DACF, infrastructure project funded from DACF faces serious challenges (Nii - Amoah, 2014). Expanding further, he outlined the following challenges as prime from the lot suffered: delays in disbursement of the fund, over deduction at source, abuse of power by parliament in the approval and disbursement of the fund, the inaccurate formula for the disbursement of the fund to the various MMDA's, mechanism for determination of the total revenue accrued and percentage allocated for the fund. According to Hamzah et al. (2009), delay in construction projects is costly and is related to four main factors such as; late payment, poor cash flow management, insufficient financial resources, and financial market instability. Centred on their findings, it was revealed that poor cash flow management is the most significant factor that leads to poor project delivery, followed by late payment, insufficient financial resources, and financial market instability respectively. According to Ali and Rahmat (2010) in Kissi et al. (2018), they concluded that, despite the immense contributions of the construction industry with regards to resources and services, there have been relentless criticisms of the poor performance in terms of quality project delivery of the major players; and these criticisms have in the recent past occasioned an interest in

several studies that focused on assessing the factors affecting project delivery in the construction industry.

Empirical evidence, however, has proved little as several studies conducted focused on the contribution of DACF to the development of MMDA's which is more concentrated on socio-economic activities but not on specifics such as building construction project delivery. This thus opens up a knowledge deficit. This study, therefore, sought to assess the factors affecting the delivery of building construction projects funded by DACF within some selected MMDA's in Ghana. This outcome will assist in examining how well the DACF concept on building construction project delivery has been adopted, operationalized, and developed in the country.

To this effect, this critical review of the of DACF utilization and the parties involved are presented.

A synthesis of studies on DACF regarding project delivery in Ghana is first presented. Also presented is the methodology employed in establishing the underlying factors affecting the delivery of building construction projects funded by DACF in the country since the post-independence era. Presentation and analysis of the factors affecting the delivery of building construction projects funded by DACF and how they can successfully aid in achieving project delivery goals were similarly presented.

## **LITERATURE REVIEW**

Building Construction Project Delivery (BCPD) is the process and procedures for the design and construction of buildings and grounds (Bill Dikis, 2015). Project delivery consists of planning, design, construction and other services necessary for organizing, executing, and completing a building facility (GKK Works, 2013). Project delivery systems are critical for achieving project success as they entail an essential aspect of an organisation's strategic planning and management processes that seek to minimise risks and uncertainties (Gisela, 2013). Frimpong et al. (2003) as cited by Kissi et al. (2018), assumed that the success of a project is cramped to the project's goals and set objectives within the explicit project scope. Similarly, the success of a project invariably depends on the level of supervision of the project or the managerial skills of the project manager or the site supervisor (Zwikael, 2009). Kissi et al. (2018) further proposed that a project is administrated by many characteristics; however, a completed project which meets its technical requirements required quality and intended duration clearly defines the success of a project. These assertions were further assented by Tengal et al. (2019) that value for money, successful project closure, end-user satisfaction, timely completion of projects and fitness for purpose were the top five monitoring and evaluation outcome features in construction project delivery. Similarly. It has been argued that one major factor that often derails project success is poor management of the delivery system, such that in many occasions underperforming delivery systems tend to undermine the inevitable uncertainties that need to be overcome to avoid project failures (Smith, 1999 in Gisela, 2013). Kissi et al. (2018) postulated that, although every project, whether construction or other non-infrastructure projects comes with their peculiar challenges, those in the construction industry are quite



similar and repetitive. They expanded further that, one would think that construction projects ought to be easier with experience, however, these flaws continue to occur over and over again especially at the local government level. In their assertion, Kissi et al. (2018) argued that inadequacies in government's work generally cause delays; as agreed by Hackman et al. (2021) who postulated that, enhanced democratic governance; improved internally generated funds; utilization of local materials improves faster infrastructure delivery. They continued that these inadequacies tend to affect project delivery, as any delay will influence the cost, time, and quality. Adding, they suggested that effective logistics management is one of the major factors for productivity increase, as such they need for efficient project delivery. It was further revealed that unrealistic timelines for the project were a huge challenge in project delivery amongst Public Work Departments (PWDs) in Ghana. This they attributed to other challenges such as inadequate designs, poor estimates, and others alike. Gisela (2013) also asserted that work delivery has been one of the effective means of realizing value for money in all spheres of life especially in the manufacturing and service provision industry, and for that matter the work delivered must be of good quality. Osei-Tutu and Adinyira (2020) also concluded in their study that, the inclusion of traditional authorities in beneficiary communities helped in an accurate identification of community needs, minimization of cost incurred and high-quality workmanship as well as strengthened ownership.

## **RESEARCH METHODOLOGY**

The study areas included Ashanti, Bono East and Greater Accra Regions of Ghana. These areas selected were due to their geographical location in Ghana and their cultural diverse ethnicity which can have an effect on Building Construction delivery as proposed by H. Danso and R.O. Kwadwo (2020); where Bono East can fairly represent the Northern-belt, the Ashanti representing the Middle-belt and the Greater Accra representing the Southern-belt of Ghana. These will make it authentic to generalise the findings obtained to fairly represent Ghana as a whole. Cross-sectional survey was employed as the design of the study. This decision was informed given the fact that the study will take a snapshot of the participants or better still be studied once and thus not necessitating the researcher to make follow-ups (Shuttleworth, 2010). The population of the study constituted officials who were knowledgeable in the construction industry constituting district coordinating directors, finance officers, head of works, planning officers, budget officers, procurement officers, internal auditors, administrators, general secretaries and programs coordinators within the various MMDA's, Ministry of local Government and rural Development (MLGRD), National Association of Local Authorities of Ghana (NALAG) and DACF secretariats. Simple random and purposive sampling techniques were used to select the sample for obtaining data for the study. Both techniques were used in choosing the institutions from the respective selected study areas. The former was used to select the MMDA's as the latter helped in selecting the DACF secretariat, National Association of Local Authorities of Ghana (NALAG) and Ministry of Local Government and Rural Development (MLGRD) from these areas. Simple random sampling is where each member of population is equally likely to be chosen as part of the sample. It has been stated that "the logic behind simple random sampling is that it removes bias

from the selection procedure and should result in representative samples (Research Methodology.net, 2019). Purposive sampling again was used to select the participants from the institutions mentioned earlier. This was possible as a list of professionals from the respective institutions were obtained from the appropriate quarters and a thorough background check run on them to lay bare those that possessed the needed knowledge relative to the study. They were contacted and used for the study eventually. The technique was used for this class since each participant was an expert with much experience and exposed in their respective fields (Saunders et al, 2012). Purposive sampling is a sampling technique in which the researcher relies on his or her own judgment when choosing members of population to participate in a study (Black, 2010). In effect, the total sample size for the study was 334 drawn from 6 agencies, namely MMDA's, Ministry of Local Government and Rural Development (MLGRD), DACF secretariat, NALAG, Consultants and Contractors were considered for the study. Questionnaire was used to collect data from respondents on the factors affecting the delivery of DACF building construction projects, and the effects of these factors on the delivery of DACF building construction projects on the factors affecting the delivery of DACF building construction projects in Ghana. This instrument was preferred on the merit that the research objectives were quantitative in nature and thus, recommended the use of this instrument coupled with the cost and the number of respondents (Kothari, 2004). A 5-Point Likert scale responses was used. A Likert scale is a set of statements (items) offered for a real or hypothetical situation under study (Joshi et al., 2015). Respondents were asked to rate the variables whether they are strongly affected (5), affected (4), neutral (3), unaffected (2) and strongly unaffected (1). Also, on measures to improve the factors affecting the delivery of DACF building construction projects and the adverse effects of these factors on the delivery of DACF building construction projects in Ghana, the variables for both objectives were rated as strongly agree (5), agree (4), neutral (3), disagree (2) and strongly disagree (1). The questionnaire also captured the demographic characteristics of the respondents. The validity of the questionnaire was determined through pilot testing, attaining a Cronbach's coefficient alpha value of 0.941 attested to the fact the items met the recommended reliability threshold. According to Hair et al. (2010), the acceptable lower limit for the Cronbach's alpha is usually considered to be 0.7, when reached will make the questionnaire reliable for data collection. 173 questionnaires representing 52% of the response rate was appropriately collected from 334 questionnaires self-administered. According to Mugenda and Mugenda (2003) in Nii and Danso (2018) and affirmed in Yehuda and Holtom (2008), this rate is acceptable as a response rate of 50% is adequate for a study. With respect to the interview, fifteen (15) of the professionals were engaged. The process took place in the office of each interviewee with a time span of between 30 minutes to 1 hour. In ensuring as well as increasing the reliability of the responses, all the interviews were recorded.

Factor analysis was performed to identify the factors affecting the delivery of DACF building construction projects in Ghana. Descriptive statistics was used to analyse data on identifying the effects of the factors affecting the delivery of DACF building construction projects in Ghana and ranked subsequently with the appropriate justifications achieved. Kendall's Coefficient of Concordance was correspondently used to establish a degree of agreement among respondents on the variables. The

quantitative data collected from the field through the use of structured closed ended items was presented in tables and analysed on Statistical Package for Social Sciences (SPSS) software version 21.

## RESULTS AND DISCUSSION

This section presents and discusses the results of the study. The focused areas included the demographic characteristics of respondents, factors affecting the delivery of DACF building construction projects, and effects of the factors affecting the delivery of DACF building construction projects delivery in Ghana.

### Demographic characteristics of respondents

**Table 1 Respondents' demographic characteristics**

Characteristics	Category/Option	Frequency	Percentage
Academic Qualification	BSc. Honours	79	45.7
	P.G. Diploma	10	5.8
	HND	33	19.1
	MSc. /MEng.	28	16.2
	MPhil.	7	4.0
	PhD.	16	9.2
	Total	173	100
Agency	MMDA	129	74.6
	Ministry of Local Government and Rural Development (MLGRD)	18	10.4
	District Assemblies Common Fund (DACF) Secretariat	4	2.3
	NALAG	4	2.3
	Contractor	12	6.9
	Consultant	6	3.5
	Total	173	100
Status in Agency	District Coordinating Director	26	15.0
	Finance officer	26	15.0
	Head of Works	24	13.9
	Planning Officer	22	12.7
	Budget Officer	26	15.0
	Procurement officer	22	12.7
	internal Auditor	3	1.7
	Administrator	14	8.1
	General Secretary	1	0.7
	Programs Coordinator	5	2.9
	Researcher	4	2.3
	Total	173	100
Work Experience	5 years or less	29	16.8
	6 - 10 years	102	59.0
	11 - 15 years	29	16.8
	Above 15 years	13	7.5
	Total	173	100
Professional Body	Yes	93	53.8
	No	80	46.2
	Total	173	100

The outline of respondents 'demographics expressed descriptively is presented in Table 1. Featuring on the table includes respondents 'academic qualification, agency, status in agency, work experience and professional body.

**Factors affecting the delivery of DACF building construction projects in Ghana.**

Factors analysis was used to categorize the components into desired dimensions as represented in Table 2. Five main factors were identified in the entire process. Various options were explored in arriving at the factors. First, although the eigenvalue with its thumb rule of 1 or greater made out seven factors, the scree plot shown in Figure 1, upon close examination and review pointed out to five factors. Again, basing on the 5% of variation explained, five factors clearly were able to make this cut cumulating to about 57%. Moreover, the five factors had theoretical considerations thus making them interpretable. Two factors less of these requirements were discarded. Regarding the variance explained, the respective individual percentages of 29.77%, 9.27%, 6.34%, 5.82% and 5.39% accordingly were assigned to component 1, component 2, component 3, component 4 and component 5.

**Table 2 Total Variance explained**

Component	Extraction Sums of Squared Loadings			Rotation Sums of Squared Loadings		
	Total	% of Variance	Cumulative %	Total	% of Variance	Cumulative %
1	10.367	29.767	29.767	5.553	15.944	15.944
2	3.229	9.271	39.039	3.145	9.030	24.974
3	2.209	6.343	45.382	3.490	10.021	34.995
4	2.027	5.819	51.201	2.763	7.934	42.929
5	1.879	5.394	56.595	2.929	8.409	51.337

Extraction Method: Principal Component Analysis

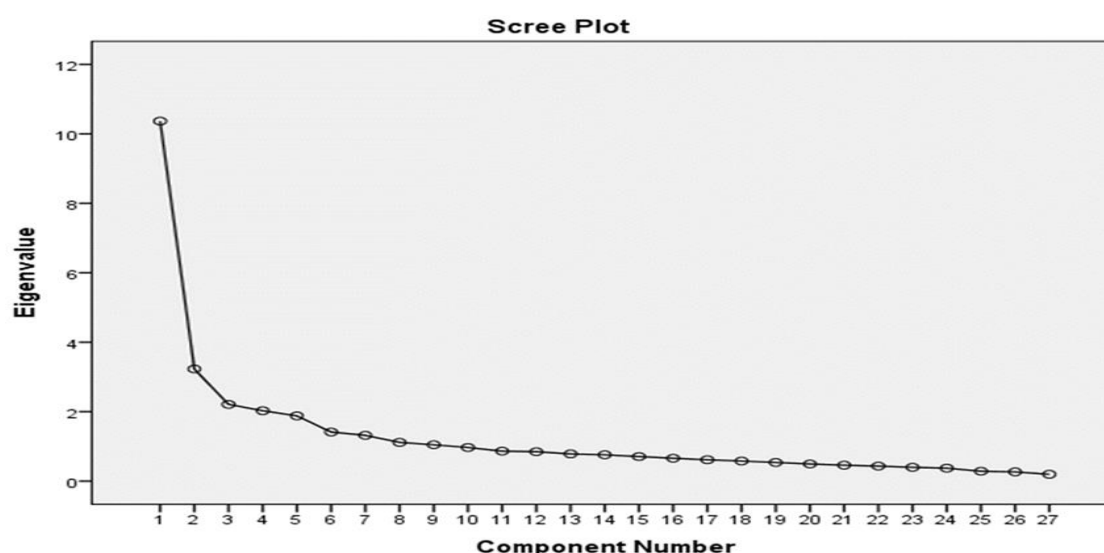

Figure 1: Scree Plot

**Table 3 Factors affecting the delivery of DACF building construction projects in Ghana. (n = 173)**

Causes	Component				
	1	2	3	4	5
Contractor's Financial Difficulties	<b>0.747</b>				
Poor site management	<b>0.731</b>				
Inefficient contractor's selection method and procedure	<b>0.699</b>				
Poor Communication	<b>0.620</b>				
Skill labour Shortage	<b>0.578</b>				
Inapplicable Guidance for the Utilization of DACF		<b>0.787</b>			
Inadequate DACF Allocation for MMDA's projects		<b>0.629</b>			
Delay in disbursement of DACF Fund		<b>0.621</b>			
Excessive Bureaucratic Conditions		<b>0.610</b>			
Poor project planning		<b>0.537</b>			
Equipment and tool Shortage			<b>0.634</b>		
Inadequate logistics			<b>0.618</b>		
Material Shortage			<b>0.638</b>		
Construction Slipups and Defective Works				<b>0.528</b>	
Weather and other Environmental Challenges				<b>0.594</b>	
Design Changes and Variation				<b>0.430</b>	
Inadequate human resource to carry out supervision					<b>0.594</b>
Unrealistic time line for project delivery					<b>0.548</b>
Lack of coordination and cooperation of stakeholders					<b>0.537</b>
Extraction Method: Principal Component Analysis. Rotation Method: Varimax with Kaiser Normalization.					
Rotation Method: Varimax with Kaiser Normalization.					

In arriving at identifying the factors affecting the delivery of DACF building construction projects in Ghana, Table 3 presents details of the factors loaded under the various components. Five factors were loaded onto component one and two with the remaining components each having three. Loading onto component one was the factors; contractor's financial difficulties (0.747), poor site management (0.731), inefficient contractor's selection method and procedure (0.699), poor communication (0.620) and skill labour shortage (0.578). This was labelled Contractor Related factors and explained 15.944% of the variance. Next was component two also with five factors of factor loadings consisting; inapplicable guidance for the utilization of DACF (0.787), inadequate DACF allocation for MMDA's projects (0.629), delay in disbursement of DACF fund (0.621), excessive bureaucratic conditions (0.610), poor project planning (0.537). This component was tagged Project Funding Related factors also explaining 9.030% of the variance. Component three came following with three factors constituting; equipment and tool shortage (0.634), inadequate logistics (0.618) and material shortage (0.638). This was labelled Supply Chain Related factors equally explaining 10.021% of the variance. Similarly, component four had three factors which included; construction slipups and defective works (0.528), weather and other environmental challenges (0.594) and design changes and variation (0.430) as it was named Site Related factors and explained 7.934% of the variance. Loaded under the fifth component were the factors; inadequate human resource to carry out supervision (0.594), unrealistic time line for project delivery (0.548) and lack of coordination and

cooperation of stakeholders (0.537) and was subsequently marked as Client Related factors and explained 8.409% of the variance.

**Table 4 KMO and Bartlett's test**

KMO and Bartlett's Test		
Kaiser-Meyer-Olkin Measure of Sampling Adequacy.		.856
Bartlett's Test of Sphericity	Approx. Chi-Square	1917.019
	Df	351
	Sig.	.000

A Kaiser-Meyer-Olkin Measure of Sampling Adequacy (KMO) and a Bartlett's Test of Sphericity (Table 4) were carried out on the data to warrant the use of factor analysis. Recording a KMO value of 0.856, the Bartlett's test in turn gave high relationships among the variables (Chi-square = 1917.019, df = 351,  $p < 0.000$ ) thus signifying the adequacy and suitability of applying this tool.

#### ***Component one: contractor related factors***

Contractor related factors under this principal component explained 29.767% of the total variance with five factors. Yaser et al., (2017) posits that poor communication among construction parties is considered one of the leading factors to cause an impact on the main project components such as cost, time and quality of construction projects. Buttressing this assertion, Nii and Danso (2018) identified excessive cost and time overrun, poor quality standard work, imprecise assessments due to lack of information, criteria being very complex and difficult to apply in practice among others as the challenges to the contractor selection criteria in Ghanaian construction industry. Many now believe that the public sector system of bid evaluation, which concentrate much on bid price, is one of the major challenges of project delivery problems (Holt et al., 1994; Ellis & Herbsman 1991; Bower 1989) as cited in Kissi et al., (2018). Affirming this claim, they explain that contractors, when faced with shortage of work are more likely to submit low bids simply to stay in business in the short term and with the hope of somehow raising additional income through 'claims' or cutting costs to compensate for their low bids. This is imperious for the managers of the economy to put the DACF high on the precedence and provide the requisite measures for the effective delivery of construction projects in the country.

#### ***Component two: project funding related factors***

The principal component accounted for 9.271 % of the total variance with five factors loading onto it. According to Amponsah (2018), and Modern Ghana (2018) delay in disbursement as well as untimely release of funds nested from inapplicable guidance for the utilization of DACF tend to pose a major challenge to the operations of the fund at the local level. Khalid and Farah (2019), in consonance with this submission also argue that poor planning and management of the construction projects may lead to several negative effects on the duration and completion of projects. This claim is linked to Igwe et al. (2018), Ahadzie and Amoah-Mensah (2010) who equally advocate that poor project management practices have in the recent past contributed to the abandonment of mass house building project as well as poor project planning and implementation culture which indicates an anti-thesis to development. In spite of these, Ahadzie and Amoah-Mensah (2010) proposed that contractors should prepare and adhere to realistic

programme schedule. The findings of the study in consistent with the observed affirmation by Igwe et al. (2018) and Ahadzie and Amoah-Mensah (2010) postulate that DACF building construction project planning and funding procedures is not serving the purpose expected at the local level, which in effect hindering the effective delivery of building construction projects required. This agitation ponders the need to review those procedures to satisfy the local needs at the MMDA's in Ghana.

***Component three: supply chain related factors***

Principal component three had three factors loading onto it and defined 6.343% of the total variance. Another crippling effect on the efficacy in delivery of DACF on building construction projects extent from the availability to the adequacy of materials for the intended projects. Kissi et al. (2018) established that inadequate logistics in the construction processes in various MMDAs have brought most construction projects to a standstill. They reiterated further that when materials ordered is not supplied to the right quantity, there is a clear case of material shortage and hence it effects on a successful project delivery. Danso (2014) affirms this assertion that, plant and equipment shortage as result of its high cost leads to poor work delivery in the Ghanaian construction industry. In the plight of these, it has become necessary for the managers of the economy to make it easy to access materials, equipment and logistics needed for the construction activities since the findings of the study concords with the reverted assertions.

***Component four: site related factors***

The principal component described 5.819 % of the total variance with three factors loading onto it. In this regard, Kissi et al. (2018) indicated that lack of precision in measurement from plans and specifications lead to mistakes in construction and extension of the project duration. They advanced their position further by adding that the weather and its attendant environmental challenges act as a great deal of a challenge to project delivery. However, in consonant with the study, it is essential for Works Department of the various MMDA's to intensify their work supervision as materials, equipment and logistics becomes available, since notwithstanding the satisfaction all aspect of building construction project delivery indicators, poor site management will render it ineffective.

***Component five: client related factors***

Then principal component clearly explained 5.394 % of the total variance with three factors loading onto it. Danso (2014) reinforced this assertion indicating that poor workmanship of construction project in the construction industry is as a result of poor supervision. In their suggestion, Oseghale et al. (2015) were emphatic that construction firms pay extra money for labour, so as delay in schedule in their construction programmes as a result of skilled labour shortage. Consolidating this idea were Kissi et al. (2018) who accentuated that unrealistic timelines for project is a huge challenge in project delivery amongst PWDs in Ghana. Moreover, they argued further that lack of stakeholder's involvement in a project affect project delivery. This was consistent with Gavizon (2013) asserting that, it is easier to get to the objective of the project when all of the participants of the team are rowing in the same direction. Relatively, Modern Ghana (2018) suggested that projects that were planned in consultation with assembly members were more successful in

contrast with those that were done in consultation with government's medium-term development plans (MTDPs).

### Effects of the factors affecting the delivery of DACF building construction projects in Ghana

Descriptive statistics was used to rank the effects of the factors affecting the delivery of DACF building construction projects in Ghana. The outcome is presented in Table 5. The criteria employed in the ranking process projected mean values of three or greater ( $\geq 3.0$ ) as the degree of measure for the main key effects of the factors affecting the delivery of DACF building construction projects in Ghana. Therefore, any mean value below 3.0 was not considered a key factor.

**Table 5 Effects of factors affecting the delivery of DACF building construction projects in Ghana.**

Effects	Mean	Std. Deviation	Rank
Cost and time overrun	3.88	1.109	1
Poor quality Standard work	3.74	1.384	2
Unexploited completed project	3.70	1.202	3
Contractor bankruptcy or liquidation	3.64	1.248	4
Causes accident/disaster	3.52	1.184	5
Loss of workers and profit	3.47	1.301	6
Loss of stakeholders' trust and confidence	3.40	1.104	7
Wastage of materials and resources	2.88	1.202	8
Dispute among Contractors and clients	2.81	1.178	9
Generate waste/scrap to harm the Environment	2.80	1.141	10
Project team isolation and conflict	2.77	1.084	11
Resource Shortages	2.77	1.090	12
Project overall failure	2.47	1.255	13

The key factors therefore included; cost and time overrun, poor quality standard work, unexploited completed project, contractor bankruptcy or liquidation, causes accident/disaster, loss of workers and profit and loss of stakeholder's trust and confidence.

#### ***Cost and time overrun***

Cost and time overrun effect pulled a mean value of 3.88; and was ranked first as the extreme effect of the factors affecting the delivery of DACF building construction projects in Ghana by respondents. Cost and time overrun effect act as a great deal of a challenge to delivery of DACF building construction projects in Ghana. Nii and Danso (2018) indicated that construction projects are subjected to excessive cost and time overrun as a result of the challenges to the contractor selection criteria in Ghanaian construction industry. With the same view point, Yaser et al., (2017); Porreca (2017) attributed this deficiency to poor communication which incurs not only cost overruns but also time overruns and consequently project failure. In-line with these deliberations, respondent indicated that cost and time overrun has been a dilemma in the MMDA's DACF construction projects, where dozens of projects exceeds the time and budget line as result of poor cash flow syndrome of DACF.



### ***Poor quality standard work***

This variable had a mean value of 3.74 and was ranked second as one of the major effects that affects DACF building construction project at MMDA's. It has been noted that building construction projects with poor quality standard work waste resources and create discomfort to end users. Danso (2014) corroborates this claim emphasizing that poor supervision of work and use of inferior or adulterated materials were identified as the major causes of poor workmanship in the construction industry. More so, MMDAs' inability to supervise construction projects effectively has resulted in a lot of conflicts, variations and poor site co-ordination (Kissi et al. 2018). Again, Nii and Danso (2018) argue that selecting a contractor for construction project is a difficult decision to be taken by a client because it may lead to construction delivery problems or successful delivery of the project.

### ***Unexploited completed project***

Standing imperious and affecting the delivery of DACF building construction projects in Ghana is unexploited completed projects which had a mean value of 3.70, indicating a major effect to DCAF building construction project. Ansah (2011) hinted that delay payment leads to abandonment of projects resulting in possible delay which virtually renders the project not available at the time required. In harmony to this affirmation, Ankukumah (2016) noted that projects are rejected by end-users/community as a result of poor inclusion of stakeholders in project delivery. In spite of these occurrences, stakeholder's involvement in the MMDA's project delivery is a challenge.

### ***Contractor bankruptcy or liquidation***

Emanating under this umbrella of factors affecting the delivery of DACF building construction projects in Ghana is contractor bankruptcy or liquidation with a mean value of 3.64. According to Ansah (2011), financial hardship for the construction companies and its impacts are sometimes so harsh that some companies have to close down. In consonance with this perspective, Ramachandra and Rotimi (2011) adds that delay and loss of payment is a serious problem in the construction industry of many countries. These affect the cash flow of contractors which is critical to meeting their financial obligations.

### ***Causes accident/disaster***

Another key component with a mean value of 3.52 underlying the factors affecting the delivery of DACF building construction projects in Ghana, is its cause to accident/disaster. Ajasa (2012) indicated that, accidents emanate from short comings of management and site managers due to non-implementation of safety policies and lack of adequate supervision. Moreover, Kavya and Pradeep (2018) relates to this call stating that accidents are bound to happen when there are lacking organization arrangements, risky practices, and weak frames of mind of development workforce, poor administration responsibility, and deficient wellbeing information and preparing of laborers. Design errors, poor quality of materials and workmanship in similar manner equally contribute to building collapse (Oke, 2011). Putting these instances into perspective to the findings shows the seriousness of MMDA's building collapse, evidence from newsghana.com, 2019 where collapse school building at Dzorwulu a suburb of Accra killed 2 and injured 6. Collapse of DACF building construction is happening and it is causing disaster and waste of resources which can be used for other relevant issue in the economy.

### ***Loss of workers and profit***

Loss of workers and profit is another canker which claimed a mean value of 3.47, situates itself as another key threat affecting the delivery of DACF building construction projects in Ghana. No wonder Abdul Raman and Berani (2006) in Ansah (2011), lays the claim that delayed payment causes the contractor's loss of workers and profit. He continuously by suggesting that contractors may not have sufficient funds to tide him over until such time as conflict is resolved, consequently lose workers. In compliance with this affirmation, Oseghale et al (2015) indicated that construction firms were paying extra money for labour, and Schedule delay in their construction programmes as a result of skilled labour shortage. This assertion confirms together with the results demonstrate the seriousness of how DACF project is abandoned due to lack of financial liquidity.

### ***Loss of stakeholder's trust and confidence***

Involved as one of the significant effects affecting the delivery of DACF building construction projects in Ghana is loss of stakeholders 'trust and confidence, attaining a mean value of 3.40. Windsor (2018) explains explicitly that it is estimated that 1 in 3 projects fail due to poor stakeholder engagement. Stakeholders are critical to project success; failure to communicate regularly with stakeholders can undermine internal support for your project. Consequently, Gamila and Rahman (2017) suggests that low Level of satisfaction among construction parties affect poor delivery of construction project. In point of view from the discussion however affirms to the findings of the need for the inclusion of stakeholders in project delivery processes.

## **CONCLUSION**

The study was set out to identify the factors affecting the delivery of building construction projects funded by District Assemblies Common Fund (DACF) in Ghana. Five main principal components came up as the factors affecting the delivery of DACF building construction projects in Ghana. These were; contractor related factors, project funding related factors, supply chain related factors, site related factors and client related factors. In identifying the effects of the factors affecting the delivery of DACF building construction projects in Ghana, the results pointed out to seven main effects. These constituted; cost and time overrun, poor quality standard work, unexploited completed project, contractor bankruptcy or liquidation, causes accident/disaster, loss of workers and profit and loss of stakeholders 'trust and confidence.

The study thus concludes that, notwithstanding the factor affecting the delivery of building construction projects funded by DCAF in the various MMDA's, its efficiency can be improved while taking a keen look at the measures to improve on the factors. In this regards, it is therefore recommended that the guideline for the utilisation of DACF should be reviewed to meet the local content at the various MMDA's by excluding the infrastructure section from the guideline and the introduction of project charter from the various MMDA's annually to serve as a benchmark to determine the type of construction project to be delivered at particular period for each MMDA. Again, DACF budget earmarked (in the project Charter) for a particular building construction project for MMDA's should be provided before commencement of its delivery process. Also, awareness creation

through seminars and training programmes must be intensified by Ministry of Local Government and rural Development on the factors affecting the delivery of DACF building construction project delivery at various MMDA's to enlightening and give them the opportunity to accept, its effect and participate actively in its recommended measures.

## REFERENCES

- Abdul-Rahman, H., Takim, R., & Min, W. S. (2009). Financial-related causes contributing to project delays. *Journal of Retail & Leisure Property*, 8(3), pp.225-238.
- Ahadzie, D. K., & Amoah-Mensah, K. (2010). Management practices in the Ghanaian house building Industry. *Journal of Science and Technology (Ghana)*, 30(2).
- Aized, T. ed., (2012). Total quality management and six sigma. BoD–Books on Demand.
- Ajasa, A. O., (2012). Effects of accidents on construction projects delivery (doctoral dissertation, department of quantity surveying, school of environmental technology, federal university of technology, akure).
- Amin, M. E. (2005). Social science research: Conception, methodology and analysis. Makerere University.
- Ankukumah, R. K. (2017). The impact of poor stakeholders involvement in the planning and implementation of construction projects case study: Accra Metropolis, Ghana (Doctoral dissertation).
- Ansah, S. K. (2011). Causes and effects of delayed payments by clients on construction projects in Ghana. *Journal of Construction Project Management and Innovation*, 1(1), pp.27-45.
- Ayettey, D. N. A., & Danso, H. (2018). Contractor selection criteria in Ghanaian construction industry: Benefits and challenges. *Journal of Building Construction and Planning Research*, 6(4), pp.278-297.
- Ayodeji, O. (2011). An examination of the causes and effects of building collapse in Nigeria. *Journal of Design and Built environment*, 9(1).
- Baruch, Y., & Holtom, B. C. (2008). Survey response rate levels and trends in organizational research. *Human relations*, 61(8), pp.1139-1160.
- Bavere, J. S. (2011). The role of the district assemblies 'common fund in local development: A comparative study of the Jaman North and South Districts (Doctoral dissertation, Master's Thesis). Department of Planning, Kwame Nkrumah University of Science and Technology, Ghana).
- Black, K. (2010). *Business Statistics: Contemporary Decision Making*. (6th ed.). London: John Wiley & sons.
- BoyeBandie, R. D. (2015). The Effects of the District Assemblies Common Fund on District Assemblies Internally Generated Revenue Mobilisation in Ghana: An Analysis of the Early Years of the Fund. *International Journal of Asian Social Science*, 5(9), pp.529-542.
- Danso, H. (2014). Poor workmanship and lack of plant/equipment problems in the construction industry in Kumasi, Ghana. *International Journal of Management Research*, 2(3), pp.60-70.
- Dikis B. (2015) Project delivery methods for public building construction: A series of Briefs on methods of design and construction for public buildings in Iowa Governmental Affairs Committee, Iowa Chapter, American Institute of Architects (AIA Iowa)

- Gaba, G. (2013). The impact of project delivery systems, cost minimizations and project control on construction project success. Evidence from Ghana (Master's thesis). University College London, London, United Kingdom.
- Gamil, Y., & Rahman, I. A. (2017). Identification of causes and effects of poor communication in construction industry: A theoretical review. *Emerging Science Journal*, 1(4), pp.239-247.
- Gavizon, V. (2013). Six key factors to successful Project delivery <https://www.workhoppers.com/blog/successful-project-delivery/>
- GKK works Company, (2013). Comparison of Project Delivery Methods <https://network.aia.org/HigherLogic/System/DownloadDocumentFile.ashx?DocumentFileKey=f2d69710-6d8b-4c83-82b2-f755dc513f65>. (Sunday 30th December, 2018 at 14:25 GMT)
- GNA., (2015), Delay in disbursement of District Assemblies' Common Fund a bane; Modern Ghana Article 2015 <https://www.modernghana.com/news/613448/delay-in-disbursement-of-district-assemblies-comm.html>
- Hackman, J. K., Ayarkwa, J., Osei-Asibey, D., Adjei-Kumi, T., & Kissi, E. (2021). Re-examining the Benefits of Decentralization for Infrastructure Delivery at the Metropolitan Municipal and District Assemblies (MMDAs) in Ghana. *Advances in Social Sciences Research Journal*, 8(2).
- Hair et al., (2010). *Multivariate data analysis*. Prentice hall
- Huang, W. C., Teng, J. Y., & Lin, M. C. (2010). The budget allocation model of public infrastructure projects. *Journal of Marine Science and Technology*, 18(5), pp.697-708
- Igwe, N. N., & Ude, A. O. (2018). Project planning and implementation in Nigeria: Revisiting international best practices. *European Scientific Journal*, ESJ, 14(14), p.152.
- Invensis. G. L. S. (2019). Who are Project Stakeholders and Why are they Important for a Project, Invensis® Global Learning Services. <https://www.invensislearning.com/articles/pmp/who-are-project-stakeholders-and-why-are-they-important-for-a-project>
- Joshi, A., Kale, S., Chandel, S., & Pal, D. K. (2015). Likert scale: Explored and explained. *Current Journal of Applied Science and Technology*, pp.396-403.
- Kahootz., (2020), The importance of stakeholders in project management success, Retrieved May, 2020 at 3:45 GMT from <https://www.kahootz.com/why-stakeholder-management-is-an-important-part-of-project-management/#:~:text=Knowing%20the%20role%20of%20stakeholders,the%20success%20of%20your%20project.&text=After%20all%2C%20keeping%20shareholders%20happy,negative%20influences%20affecting%20your%20project>
- Kalla S., (2011). *Relationship Between Variables*
- Kavya, K., & Pradeep, T. (2019). Causes and Effects of Construction Accidents. *International Journal of Innovative Technology and Exploring Engineering (IJITEE)* ISSN: 2278-3075, Volume-9 Issue-2, December 2019
- Khalid, F. J. I. (2019). The Impact of Poor Planning and Management on the Duration of Construction Projects: A Review.

- Kissi, E., Mohammed, S. A., & Owusu-Diatuo, K. J. (2018). Challenges facing public works departments in construction project delivery within metropolitan municipal and district assemblies in Ghana. *UDS International Journal of Development*, 5(1), pp.129-143.
- Madadzadeh, F. (2020). Popular Statistical Tests for Investigating the Relationship between Two Variables in Medical Research. *Journal of Community Health Research*, 9(1), pp.1-3.
- Newsletter Ghana statistical service.,2020  
[https://www.statsghana.gov.gh/gssmain/fileUpload/National%20Accounts/Newsletter%20quarterly%20GDP%202020%20\\_Q3\\_December%202020%20Edition.pdf](https://www.statsghana.gov.gh/gssmain/fileUpload/National%20Accounts/Newsletter%20quarterly%20GDP%202020%20_Q3_December%202020%20Edition.pdf)
- Ngacho, C., & Das, D. (2015). A performance evaluation framework of construction projects: insights from literature. *International Journal of Project Organisation and Management*, 7(2), pp.151-173.
- Nii-Amoah N. (2014). The Common Fund Newsletter, issue 2 – December, 2014 DACF and Decentralization objective.
- Ofori, G. (2012). Developing the Construction Industry in Ghana: the case for a central agency. A concept paper prepared for improving the construction industry in Ghana. National University of Singapore, pp.3-18.
- Oseghale, B. O., Abiola-Falemu, J. O., & Oseghale, G. E. (2015). An Evaluation of Skilled Labour shortage in selected construction firms in Edo state, Nigeria. *American Journal of Engineering Research*, 4(1), pp.156-167.
- Osei-Tutu, E., Adinyira, E., Ofori, A. P., Asamoah, R., & Ankrah, S. J. (2019). Promoting Partnership with Traditional Authorities in Development Projects: A Model for Community Infrastructure Project Delivery in Ghana. *Ghana Journal of Science*, 60(2), 84-98
- Owusu-Amponsah, V., (2017). Effects of the District Assembly Common Fund (DACF) on socio-economic development in Ghana: a case study of Tano-South District assembly in the Brong Ahafo Region of Ghana (Doctoral dissertation, University of Cape Coast).
- Porreca L., (2017). How Poor Communication can have an Impact on your Project, <http://7dailyhabits.com/how-poor-communication-can-have-an-impact-on-your-project/>
- Tengan, C., Aigbavboa, C. O., Guribie, F., & Annor-Asubonteng, J. (2019)., "Analysis of the outcome features of effective monitoring and evaluation in construction project delivery", *Journal of Engineering, Design and Technology*, Vol. 17 No. 6, pp. 1192-1201. <https://doi.org/10.1108/JEDT-03-2019-0076>
- Vaardini, S., Karthiyayini, S., & Ezhilmathi, P., (2016). Study on cost overruns in construction projects: a review. *International Journal of Applied Engineering Research*, 11(3), pp.356-363.
- Windsor, G. (2018). A Quick Guide to the Project Management Office.
- Zwikael, O. (2009). Critical planning processes in construction projects. *Construction innovation*.



## FACTORS INFLUENCING PERCEIVED VALUE OF RESIDENTIAL PROPERTIES IN FREE STATE PROVINCE, SOUTH AFRICA

Kahilu Kajimo-Shakantu<sup>1</sup>, Barend Groenewald<sup>2</sup> and Timothy O. Ayodele<sup>3</sup>

<sup>1,2,3</sup>*Department of Quantity Surveying and Construction Management, University of the Free State, Bloemfontein, South Africa*

Various factors influence the value of property and may differ between the different stakeholders in the residential property market. Limited research focuses on the concept of perceived value and how it differs between the professional valuers, real estate agents and homeowners. The aim of this study is to determine the factors that increase the value of residential properties as perceived by homeowners, real estate agents and professional valuers. The study adopted quantitative data, collected through questionnaires distributed among homeowners, real estate agents and professional valuers. Both descriptive and inferential statistics were adopted for data analysis. The results of the study indicated that different stakeholders in the property industry perceive the factors that affect the value of residential properties differently. Professional valuers are far less likely to allocate great importance to single factors that may have an influence on residential property. The results also indicated that certain individual factors that affect property values are perceived as being more important than others by the different groups. Based on the results, it is recommended that concepts such as perceived value are included in training programs for professionals to better understand factors that homeowners perceive as value adding to their properties. Future research can investigate the reasons why certain factors are valued differently by the different groups and how gender influences the perceived value of residential property.

Keywords: homeowners, professional valuers, property value determinants, real estate agents, residential property

### INTRODUCTION

Value is a multifaceted construct, influenced by numerous factors (Australian Property Institute [API], 2015). A factor that plays an important role in the determination of the value of residential property, is the individual conducting the valuation (API, 2015). There are many different role players in the property market with diverse knowledge, experience and qualifications and thus different perceptions of valuations can be expected (API, 2015). Professional valuers base their valuation on expert conclusions that are based on market evidence and

---

<sup>1</sup> kajimoshakantuk@ufs.ac.za

<sup>2</sup> bar3nd@gmail.com

<sup>3</sup> ayodele.t.oluwafemi@gmail.com

proven methods (Blackledge, 2017). Real estate agents equally base their valuation on market evidence, but are however, limited with regard to different valuation methods and types of properties (API, 2015). While homeowners are constrained to make a professional valuation of a property because of their subjectivity and lack of knowledge, homeowners however, subjectively estimate the value of their property based on their perceived value of the property (Lundgren, 2013).

According to Sánchez-Fernández and Iniesta-Bonillo (2007), perceived value is a multi-dimensional construct that exists between the consumer and product, influenced by personal, situational, preferential, perceptual and cognitive affective aspects. As value is influenced by personal aspects, it is possible for homeowners to overestimate the value of their property (Van der Crujisen, Jansen, & Van Rooij, 2018). Van der Crujisen et al. (2018) emphasize the importance of homeowners to be knowledgeable about the "true" value of their home, as opposed to their perceived value, as it might influence their financial decisions, including household spending and saving decisions.

Most homeowners also frequently have misconceptions when they are in the process of selling their home (Forbes Real Estate Council, 2018). Sometimes homeowners in a bid to increase the sales price of their property, make alterations and improvements, and these improvements rarely add value to the property (Forbes Real Estate Council, 2018). Homeowners also perceive their home to be more valuable due to sentimental ties to the property which might not align with the market value (Forbes Real Estate Council, 2018). Conversely, home buyers make property valuations based on the property's physical conditions and the available market information (API, 2015). A home buyer can also pay significantly higher for a property with attributes that they highly value (Adetiloye & Eke, 2014). The foregoing presupposes that property is valued by potential/existing homeowners based on subjective estimates and such estimates differ from that of real estate agents and professional valuers (API, 2015). Property valuation is a complex process that should only be formally undertaken by professional valuers, real estate agents on the other hand tend to often make estimations of property's market price based on their market experience (API, 2015).

The key problem therefore is that homeowners naturally run the risk of overestimating the value of their property (Benitez-Silva et al., 2015; Van der Crujisen et al., 2018; Windsor, La Cava, & Hansen, 2015). When homeowners overestimate the value of their property, it can lead to poor economic decisions, such as household spending and saving decisions in the long term (Van der Crujisen et al., 2018). Furthermore, homeowners might invest and modify their home before selling, believing that these improvements/alterations may increase the value of their property and therefore the final selling price (Forbes Real Estate Council, 2018). This can potentially place the homeowner in a weaker financial position than prior to the improvements. A study investigating the ability of homeowners to accurately calculate the value of their property found that homeowners overestimated the value of their homes with a range of 3,4% - 12,7% (Benitez-Silva et al., 2015). Windsor et al. (2015) similarly found some positive bias among homeowners when valuing their homes and a positive correlation between overestimation and financial spending. The perceived value is therefore a construct that is based on subjective assumptions and can differ among different role players

in the property market (Lundgren, 2013). Therefore, this study identified the need to investigate how homeowners' perceptions differ regarding key factors which they perceive as the most important for increasing the value of residential properties as compared to professional valuers and real estate agents.

Literature search suggests a dearth of studies in the South African property market examining the factors that contribute to the value of residential properties from the viewpoint of homeowners, real estate agents and professional valuers. Given the role of housing on the regional economic growth in South Africa (Simokengne, Bittencourt, & Gupta, 2012), a need exists to conduct market specific studies to investigate different factors that influence property value from the stakeholders perspectives. Towards this end, this study investigates variations in the perceptions of homeowners', estate agents and professional valuers regarding key factors which they perceive as the most important for increasing the value of residential properties.

## **LITERATURE REVIEW**

The literature review examined two main discussions. While the first subsection discussed the perceived value, the second focused on the factors influencing residential property value

### **Perceived value**

Value is a multifaceted construct, as value is not inherent to the product, but changes according to various influential factors (API, 2015). The value of a product, in this case property, can therefore change over time and can be considered a subjective opinion, and not a fact (Blackledge, 2017). Value is a complex, multi-dimensional construct that is found within an interaction between the consumer and a product (Sánchez-Fernández and Iniesta-Bonillo, 2007). It is also influenced by various factors such as personal, situational, preferential, perceptual and cognitive affective aspects (Sánchez-Fernández & Iniesta-Bonillo, 2007). There is a difference between the developer's perception and the consumer's preference with regard to value (Rahadi, et al., 2012). The concept of perceived value is therefore idiosyncratic, as different individuals have different meanings when referring to value.

The process of valuation is defined by the API (2015) as "the act or process of developing an opinion of value". This process includes using data, analytical techniques and applying knowledge, experience and professional judgment. The opinion of the valuer is therefore based on expert conclusions that are based on market evidence. Professional services are needed with the valuation process as the determination of the value of residential property is a complex process, influenced by law, location construction and condition (Mackmin, 2008). Experience and education are therefore needed to make a qualified estimation of value (Mackmin, 2008). An estate agent can provide a valuation for the potential seller, in order to ascertain a buyer but it is not guaranteed that the estate agent will use a professional qualified valuer (Mackmin, 2008). Real estate salespeople and agents develop expertise in valuation; however, they might not base their findings on the factors that professional valuers include (API, 2015).



Homeowners will inevitably estimate the value of their property. However, such estimation of the value is not always correct (Agarwal, 2007). Van der Crujisen et al. (2018) found homeowners to have an optimistic estimate of their property. Van der Crujisen et al. (2018) postulates that psychological explanations for the misestimation include theories such as loss aversion or an endowment effect, where the homeowner will over-value their property. The inaccurate estimation of value can also be due to the lack of information (Henriques, 2013). Over estimation of value can also happen even if homeowners are well informed (Van der Crujisen et al., 2018). If a homeowner overestimates the value of their home, it can lead to poorer important economic decisions, including household spending and saving decisions, leading to negative consequences (Van der Crujisen et al., 2018). It is also important for homeowners not to overestimate the value of their home, as it might lead to high asking prices when selling their home, which can delay the selling process (Van der Crujisen et al., 2018).

Wang et al. (2004) state that clients perception of value, when used correctly, can be applied as an approach to enhance competitiveness, attract and retain customers. Zauner, Koller, and Hatak (2015) adds that consumer perceived value can be incorporated and used in business models, including in areas such as marketing and management. Consumer perceived value can therefore be regarded as a competitive advantage in practice (Zauner et al., 2015).

### **Factors influencing residential property value**

Various factors that increase a property's value are discussed in the literature. These factors may be referred to as property value determinants (Abidoye et al., 2016; Mackmin, 2008). Various studies investigated the different conditions and external and internal factors that plays a role in the perceived value of residential property. Żróbek et al. (2015) presents a summary of the attributes developers consider as important in the residential property market. These attributes include the physical conditions, distances to markets, the opportunity for employment, neighborhood factors, the availability of health care and recreational areas, among others. In the study of Carnoske et al. (2010) realtors indicated various factors that influenced potential purchases. These factors included, but not limited to, perception of affordability, level of neighborhood safety and standard of neighborhood schools.

Location is an important factor that forms part of the value determinants of property. Various studies, including Abidoye et al. (2016) found location to be the most highly valued factor when residential decisions are made. Romkaew (2001) explains that the link of location and the perceived value of the residential property is determined by how well the neighborhood characteristics fulfill the needs of the residents. An example is provided where single families requires access to schools, shopping and employment centers (Romkaew, 2001). Location is emphasized by Coffee et al. (2013) to be the determinant that adds the most value to residential property. The study of Teck-Hong (2011a) also found that the value of residential property increased with location and accessibility, specifically the distance to the workplace, hospitals and public transport. Ferlan et al. (2017) investigated factors influencing the appraised value of residential properties as perceived by different experts. Their findings were that the location in relation to the distance from the city center was the factor that influenced value the most.

Structural attributes of residential properties can play a significant role in the value of property (Dziauddin & Idris, 2018). Structural factors can include, among others, the number and size of rooms (bedrooms and bathrooms), the age and size of the property, fire places, and swimming pools (Oloke et al., 2013). Teck-Hong (2011b) also includes flooring and tiling as structural attributes. Aliyu (2012) states that the value of residential property is determined by structural components of the building, where structural components such as flooring, the type of roof, finishes and decorative aspects can add value to a property. In comparison, properties without these attributes may be viewed as less valuable (Aliyu, 2012). Studies found various factors that increased perceived value, for example functionality and spaciousness (Kauko, 2006), natural daylight and a well proportional layout (Lundgren, 2013) the size, number of bathrooms, location, an environmental attribute (Choudhury, 2017), flooring and finishes (Teck-Hong, 2011b), "green" amenities, including solar and wind power and sealed windows (Carnoske et al., 2010). The state of repair of a property can include aspects such as the finishes and aesthetics of a property. This was found to be an important variable of determining the value of residential property in the study of Abidoye et al. (2016). Ferlan et al. (2017), included, amongst other factors, the residential property orientation, noise level, floor level and the age of the building. The age of the property was found in the study to have had a negative influence on the property value.

Neighborhood characteristics can play a significant role in the value of property (Abidoye et al., 2016; Matthews & Turnbull, 2007). Potential home buyers will develop expectations for their new residential property based on their observations about their image of the neighborhood, which includes the location, availability of amenities, transport and various facilities (Lundgren, 2013). As an example, the quality of the surrounding environment was found in Żróbek et al. (2015) to significantly influence the value of property. Neighborhood factors can include estate plans, infrastructure development, and security (Oloke et al., 2013). Drewnowski, Aggarwal, Rehm, Cohen-Cline, Hurvitz, and Moudon (2014) found that if the neighborhood were perceived as safe, quiet, clean and attractive, the property values were higher. Park facilities also may contribute to the property values, where passive recreation with recreation space, water features and gardens were found to add to value in the study of Lin, Wu, and Sousa (2013). Respondents from the study of Żróbek et al. (2015) identified a sense of security as a factor that were valued by property buyers. A quiet neighborhood, high scenic value was also highlighted. Being able to relax in the neighborhood and feeling safe had the highest impact on the customer perceived value in a study conducted by Lundgren (2013). Other factors such as poor conditions in a neighborhood, including rundown building exteriors, lawn problems, lack of street and walkway maintenance was also found to be associated with declining sales prices (Seo, 2018) as was pollutant emissions, noise and externalities that are produced by heavy infrastructures (Cordera, Chiarazzo, Ottomanelli, dell'Olio, & Ibeas, 2019).

There are numerous reasons why knowledge of these property value determinants are important. Determining what factors is viewed as increasing the value of residential property can be used by real estate experts to make adjustments to sale prices and determine the influence of various factors with more certainty (Ferlan et al., 2017). Also, if it is known what the preferences is, or the factors that influence the choice of residential property, this knowledge can be incorporated in the

design of residential property. Urban planning could be based on these factors and can indicate which factors must be prioritized (Żróbek et al., 2015). Furthermore, Teck-Hong (2011a) agrees that it is important for housing developers to have detailed knowledge of preferences of potential home buyers. The reason they provide is that home buyers have different perceptions and opinions of what they consider to be important. A more holistic view of what factors adds value to residential property is therefore recommended (Teck-Hong, 2011a), as it will contribute to residential environments that homebuyer's value (Żróbek et al., 2015).

## **METHODOLOGY**

An empirical study was undertaken which, epistemologically, followed a non-experimental, quantitative methodology, grounded in the positivist paradigm. The study focused on three target population groups: homeowners, real estate agents and professional valuers. Homeowners was selected through a non-probability sample selection method namely, convenience sampling. Real estate agents registered at the EAAB and professional valuers registered at the SACPVP were requested to participate in the study and were also selected through a convenience sampling method. Given the need to ensure equal proportion among the three categories of respondents, and get the best representation of respondents for each category of respondents in the final sample, the number of respondents for each category was selected using controlled quota sampling.

A closed ended questionnaire was used to collect data. An informed consent section formed part of the questionnaire. The researcher provided homeowners, real estate agents and professional valuers each with a questionnaire by means of an online survey and/or by hand. The first section of the questionnaire included the demographic details of the respondents. The second section included a list of factors that are perceived to increase the value of residential properties as based on the literature review. Participants were asked what percentage of the time a change in different factors will affect their view of a house's value by more than 20%. Their responses were indicated on a 6-point scale and included: < 5%, 5% - 25%, 26% - 50%, 51% - 75%, 76% - 95% and > 95%. The list of factors prepared and put forward to the respondents included the following: location; size of the property; state of repair; number of rooms; age of the property; newly painted and tiled; flat roof/pitched roof; neighborhood characteristics; availability of security; and accessibility to a highway. In the last section, participants were asked to rank the ten factors which may have an influence on the value of property in order of importance. Statistical analysis included both descriptive and inferential statistics. Chi Square tests were conducted for each question. Differences in averages were tested with ANOVA tests. The significance level chosen for this study was 0.05. Approval for this study was requested from the ethics committee of the University of the Free State.

The following hypotheses was investigated in the study:

### ***Hypothesis 1***

1. H0: Homeowners, real estate agents and professional valuers perceive the factors that affect the value of residential properties the same.

- H1: Homeowners, real estate agents and professional valuers perceive factors that affect value of residential properties differently.

**Hypothesis 2**

- H0: Individual factors that affect property values are perceived to have equal importance by homeowners, real estate agents and professional valuers.
- H1: Certain individual factors that affect property values are perceived as being more important than others by homeowners, real estate agents and professional valuers.

**RESULTS**

**Respondents Profile**

An examination of the respondents 'profile (Table 1) showed that majority of home owners were females (66.7%), the gender analysis of the estate agents showed that females (51.6%) were slightly more than the males (48.4%). However, among the professional valuers, the results revealed that the males accounted for 89.7% while the females were 10.3% of the respondents.

**Table 1: Respondents' Profile**

Profile	Home owners (n = 30)		Estate Agents (n = 31)		Professional Valuers (n = 29)		
	Frequency	Percentage	Frequency	Percentage	Frequency	Percentage	
Gender	Male	10	33.3	15	48.4	26	89.7
	Female	20	66.7	16	51.6	3	10.3
	Total	30	100.0	31	100.0	29	100.0
Age	18-29 years	0	0.0	2	6.5	1	3.4
	30-39 years	10	33.3	6	19.4	5	17.2
	40-49 years	6	20.0	7	22.6	10	34.5
	50-59 years	7	23.3	11	35.5	7	24.1
	60+	7	23.3	5	16.1	6	20.7
	Total	30	100.0	31	100.0	29	100.0
	Years of Experience in the Property Market	0 years	3	10.0	0	0.0	0
1-5 years		14	46.7	8	25.8	3	10.3
6-10 years		5	16.7	7	22.6	3	10.3
11-20 years		2	6.7	13	41.9	12	41.4
20+ years		4	13.3	3	9.7	11	37.9
No Response		2	6.7	0	0.0	0	0.0
Total		30	100.0	31	100.0	29	100.0

Analysis of the respondents age showed that most of the respondents across the three categories were aged 40 years and above. Regarding the years of experience of the respondents in the property market, the results showed that while only 10% of home owners have no experience in the property market, 48.4% of estate agents have up to 10 years 'experience. A total number of 79.3% of professional valuers have at least 11 years 'experience in the property market. The results showed that the respondents have some measure of experience in the property market, and should be able to provide reliable responses.

### Factors that increase the value of residential property

The data obtained was split by gender, age, experience and population group. A p-value of  $\leq 0.05$  was accepted as a statistically significant difference between data groups. No statistically significant difference was found when data was split by age and experience. When the data was split by gender, the females rated the influence of the factors on property value to be in general more important than males. In the case of size of property, number of rooms, if property was newly painted and tiled as well as age of property, these were statistically significant at  $p \leq 0.05$  (Figure 1).

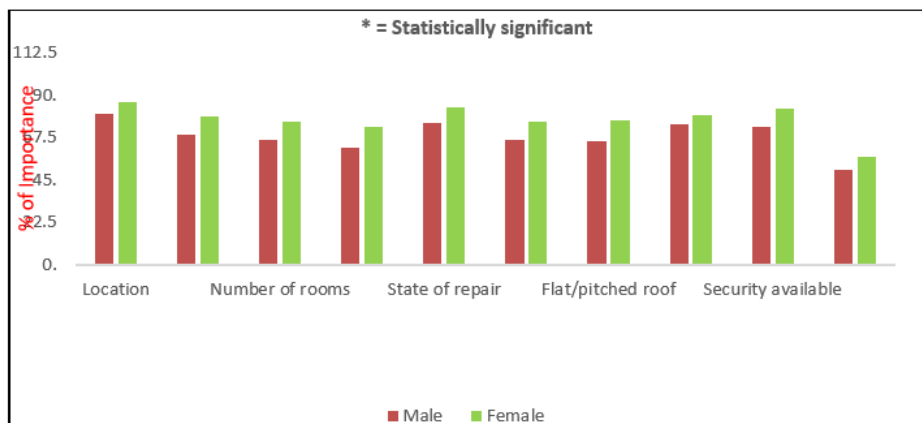

Figure 1: Factors that affect Property value as reported by different genders

The study further sought to evaluate the respondents' perception on the importance of housing features/characteristics on property values. The analysis was disaggregated based on the population group. When split by population group, professional valuers rated the influence of the above-mentioned factors on property value to play in general a lesser role. This perhaps might owe to the expectation that economic forces have a major role to play in determining property value, as opposed to individual items assessed in isolation. Property attributes that were statistically significant at  $p < 0.05$  are size, number of rooms, age of property, painted and tiled, flat/pitched roof and availability of security (see Figure 2).

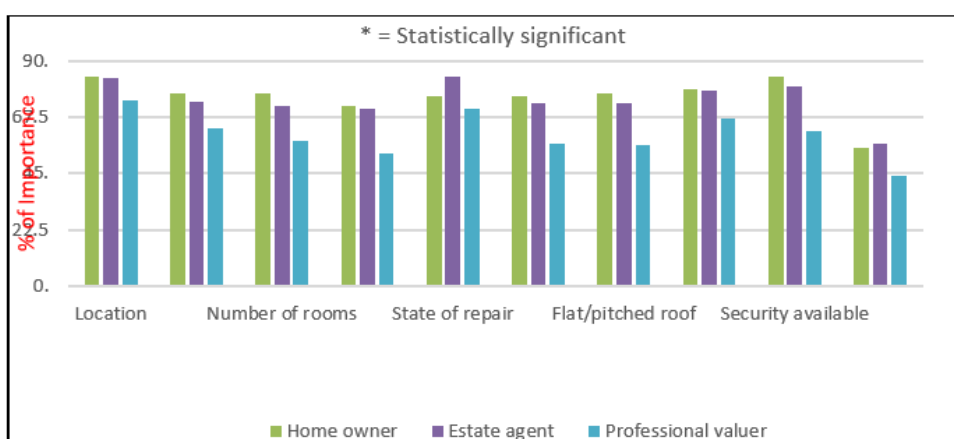

Figure 2: Factors that affect Property value as reported by the population groups

An examination of the modal scores/weightings attached to the features/factors (see Table 2) shows that homeowners rated a 5 point for most of the variables. Only proximity to highway was rated a 3 point. This suggests that home owners expect that these attributes/features significantly translate into increased values

for their property. It thus appears that the homeowners do not give consideration to other peculiar market idiosyncrasies when subjectively assessing the value of their property. Concerning the estate agents, while the least rates feature was proximity to highway (3 points), the highest features were location, repairs and security (6 points). The features/attributes had lower weightage in comparison to the ratings of the homeowners. The differences in the rating might owe to the better understanding of the market peculiarities and factors influencing property values. The ratings of the professional valuers further attributed lower modal scores to the features/factors, with proximity to highways having a modal score of 1, and location, repair and neighbourhood having a modal score of 5. It thus appears that the ratings of the professional are not driven by personal bias, rather a realistic appraisal driven by market fundamentals. Apparently, there are other factors such as cost of development, nature/type of title are some other major issues that attract considerations when estimating market prices/values from the professional perspectives of the property valuers.

**Table 2. Scores/weightings attached to the property features**

Features	Home owners (n = 30)		Estate Agents (n = 31)		Professional Valuers (n = 29)		
	Frequency	Percentage	Frequency	Percentage	Frequency	Percentage	
Location	5%-25%	1	3.3	2	6.5	2	6.9
	26%-50%	1	3.3	3	9.7	6	20.7
	51%-75%	5	16.7	2	6.5	5	17.2
	76%-95%	12	40.0	9	29.0	10	34.5
	>95%	11	36.7	15	48.4	6	20.7
	<i>Modal Score</i>	5		6		5	
Size	< 5%	-	-	-	-	1	3.4
	5%-25%	-	-	2	6.5	3	10.3
	26%-50%	4	13.3	4	12.9	9	31.0
	51%-75%	10	33.3	8	25.8	9	31.0
	76%-95%	9	30.0	12	38.7	4	13.8
	>95%	7	23.3	5	16.1	3	10.3
Rooms	<i>Modal Score</i>	4		5		4	
	< 5%	-	-	1	3.2	-	-
	5%-25%	-	-	-	-	5	17.2
	26%-50%	4	13.3	5	16.1	11	37.9
	51%-75%	8	26.7	12	38.7	9	31.0
	76%-95%	13	43.3	9	29.0	3	10.3
Property age	>95%	5	16.7	4	12.9	1	3.4
	<i>Modal Score</i>	5		4		3	
	< 5%	1	3.3	1	3.2	1	3.4
	5%-25%	1	3.3	2	6.5	6	20.7
	26%-50%	6	20.0	5	16.1	13	44.8
	51%-75%	6	20.0	10	32.3	7	24.1
Repair	76%-95%	11	36.7	7	22.6	1	3.4
	>95%	5	16.7	6	19.4	1	3.4
	<i>Modal Score</i>	5		4		3	
	< 5%	-	-	1	3.2	-	-
	5%-25%	2	6.7	1	3.2	2	6.9
Repair	26%-50%	5	16.7	1	3.2	5	17.2
	51%-75%	6	20.0	4	12.9	8	27.6
	76%-95%	8	26.7	11	35.5	12	41.4

Table 2. cont'd Scores/weightings attached to the property features

	>95%	9	30.0	13	41.9	2	6.9
	<i>Modal Score</i>	6		6		5	
	< 5%	-	-	-	-	2	6.9
	5%-25%	2	6.7	2	6.5	7	24.1
	26%-50%	4	13.3	6	19.4	7	24.1
Painted	51%-75%	8	26.7	7	22.6	7	24.1
	76%-95%	8	26.7	9	29.0	4	13.8
	>95%	8	26.7	7	22.6	2	6.9
	<i>Modal Score</i>	5		5		3	
	< 5%	1	3.3	-	-	1	3.4
	5%-25%	2	6.7	4	12.9	5	17.2
	26%-50%	1	3.3	4	12.9	12	41.4
Roof	51%-75%	6	20.0	8	25.8	5	17.2
	76%-95%	14	46.7	8	25.8	4	13.8
	>95%	6	20.0	7	22.6	2	6.9
	<i>Modal Score</i>	5		5		3	
	< 5%	-	-	-	-	-	-
	5%-25%	-	-	1	3.2	5	17.2
	26%-50%	3	10.0	1	3.2	7	24.1
Neighbour hood	51%-75%	8	26.7	12	38.7	5	17.2
	76%-95%	7	23.3	8	25.8	8	27.6
	>95%	11	36.7	9	29.0	4	13.8
	No response	1	3.3	-	-	-	-
	<i>Modal Score</i>	6		4		5	
	< 5%	1	3.3	-	-	1	3.4
	5%-25%	1	3.3	2	6.5	4	13.8
	26%-50%	1	3.3	3	9.7	6	20.7
Security	51%-75%	2	6.7	6	19.4	12	41.4
	76%-95%	13	43.3	8	25.8	4	13.8
	>95%	12	40.0	12	38.7	2	6.9
	<i>Modal Score</i>	5		6		4	
	< 5%	3	10.0	2	6.5	8	27.6
	5%-25%	7	23.3	4	12.9	6	20.7
	26%-50%	7	23.3	12	38.7	7	24.1
Highway	51%-75%	7	23.3	7	22.6	5	17.2
	76%-95%	3	10.0	5	16.1	3	10.3
	>95%	3	10.0	1	3.2	-	-
	<i>Modal Score</i>	3		3		1	

### Order of importance of factors that increase the value of residential property

When data was split by gender, females rated number of rooms to be more important than males ( $p = 0.00$ ), while males rated neighborhood significantly higher than the females ( $p = 0.00$ ). Analysis based on age, population group and experience were not significant.

### Hypothesis evaluation

When the data was split by occupation, the global hypothesis of no significant difference was rejected. Professional valuers valued the influence of the different factors on property as statistically significant ( $p \leq 0.05$ ) lower than home owners and real estate agents.

Home owners and estate agents valued the size of property, number of rooms, age of property, painted and tiled, flat/pitched roof and availability of security to be

significantly ( $p \leq 0.05$ ) more important than perceived by professional valuers. Therefore, according to this study, certain individual factors that affect property values are perceived as being more important than others by homeowners, real estate agents and professional valuers (H1).

**Table 3. Ranking of the level of importance of property features/facilities**

Features	Home owners (n = 30)			Estate Agents (n = 31)			Professional Valuers (n = 29)		
	Mean	Std. Dev.	rank	Mean	Std. Dev.	rank	Mean	Std. Dev.	rank
Location	2.27	1.999	10	1.45	1.287	10	2.00	2.360	10
Size	4.00	2.101	8	4.06	1.982	9	4.07	2.618	9
Repair	3.80	2.107	9	5.13	2.141	8	4.21	1.760	8
Rooms	4.67	2.187	7	5.35	2.288	7	5.66	2.126	6
Age	6.07	2.258	5	5.97	1.760	4	5.79	1.677	5
Painted	7.10	1.954	2	6.10	1.989	3	6.24	1.939	3
Roof	6.77	2.459	3	6.16	2.818	2	7.52	2.198	2
Neighbourhood	5.13	2.623	6	5.90	2.891	5	4.86	2.587	7
Security	6.33	2.771	4	5.74	2.863	6	6.24	2.668	4
Highway	8.87	2.030	1	9.10	2.055	1	8.41	2.994	1

An examination of the ranking of the level of importance of the individual features/facilities to the respondents (table 3) showed that homeowners rated highway, painting and roof more highly than other housing features. The mean scores of the estate agents and professional valuers were similar. Both groups rated highway and roof (Estate Agents mean score – 9.10 and 6.16 respectively; Professional valuers mean score – 8.41 and 7.52 respectively) more highly than other features. The least ranked feature across all the categories of respondents was location, this had a mean rank of 2.27, 1.45 and 2.00 for the homeowners, estate agents and professional valuers respectively.

## DISCUSSIONS

The concept of perceived value is a multifaceted concept with various influential factors. The results of the study can be interpreted against the literature study. The API (2015) views value as a multifaceted construct influenced by numerous factors, where the individual that conducts the valuation plays an important role. Differences in valuation are explained by the individual conducting the valuation, as the individuals differ with regards to knowledge, experience and qualifications (API, 2015). Based on the findings of the study, professional valuers are far less likely to allocate greater importance to single factors that may have an influence on the value of residential property. This might indicate the propensity of professional valuers to base their valuations on a far broader range of factors, which might include other value determinants, such as economic conditions and comparative analyses, which were not included in the study. The findings from the study corroborates the results of Blackledge (2017) who submitted that professional valuers base their valuation on expert conclusions that are premised on market evidence and proven methods as oppose to individual property attributes/features. This might explain why the results indicated that professional



valuers did not place too much emphasis on the individual factors listed in the questionnaire as a professional valuation requires a holistic approach.

Home owners rated the factors influencing property value in general higher. This finding might possibly indicate that homeowners, due to their subjectivity and lack of knowledge, overvalue their property if it includes certain factors that do not necessarily influence the market value of residential property – as determined by professional valuers and real estate agents. Also, this might lead to a susceptibility of homeowners to make adjustments to their property, incorrectly believing that these factors might increase the value of their building. Homeowners are also prone to subjectivity and do not have knowledge of how to conduct professional valuations. Therefore, estimations of the value of their property are based largely on their perceived value of the property (Lundgren, 2013), influenced by personal, situational, preferential, perceptual, cognitive affective aspects and sentimental ties (Forbes Real Estate Council, 2018; Sánchez-Fernández & Iniesta-Bonillo, 2007). As value is also influenced by personal aspects, it is possible for homeowners to overestimate the value of their property (Benitez-Silva, Eren, Heiland, & Jimenez-Martin, 2015; Van der Crujisen et al., 2018; Windsor, La Cava, & Hansen, 2015). This could possibly explain why the study found that home owners seemed to rate the factors to influence property value generally higher than compared to real estate agents and professional valuers.

The results of the study also emphasised the role of gender, where the perception of the importance of factors did not differ between groups of occupations, but between males and females, where females rated the number of rooms to be more important and males rated neighbourhood factors significantly higher than females.

The results must be interpreted against the limitations of the study. The small sample size (selected through a non-probability sampling method) might not be representative of the rest of the population - therefore limiting the results to be generalized beyond the sample group. Due to the small sample size, gender was not equally represented in the different occupational groups (only 4 females in the group of professional valuers). The questionnaire included a limited amount of factors that influence the perceived value of residential property.

Due to the limitations of the current study, further studies may be necessary to determine which factors increases the value of residential properties as perceived by homeowners, real estate agents and professional valuers in order to provide guidelines to homeowners to make better economic decisions before selling or buying new property. Reasons why specific factors are perceived as being valuable and/or more valuable than others can also be elicited. Future research can explore how the concept of perceived value differs not only between role players in the industry, but also how it differs between genders.

## **CONCLUSION**

In recent years, the concept of perceived value in the property market is becoming increasingly important. This is because the perceived value of customers can also be used by professional property developers when new projects are planned,

thereby aligning their plans with the values of the customers (Lundgren, 2013). A preliminary literature review undertaken found limited studies that specifically focused on factors that influence the perceived value in the property market. The study therefore adds to the current body of knowledge in the area of valuation to better understand how personal perceptions of different groups might influence the property market. Professional valuers and real estate agents may also use the outcome of the proposed study in training programs to better understand consumers and develop more insights into factors that consumers perceive as value adding to their properties.

## REFERENCES

- Abidoeye, R. B., Chan, A.P.C., & Oshodi, O. S. (2016). Factors that influence real estate project investment: Professionals 'standpoint. In: Windapo, A.O., Odediran, S. J. & Adediran, A. (Eds.). *Emerging trends in construction organizational practices and project management knowledge areas: Proceedings of the 9th cidb conference proceedings*. [online]. Cape Town, South Africa: Department of Construction Economics and Management, University of Cape Town, pp. 229-239. Available from: <https://openbooks.uct.ac.za/uct/catalog/view/cidb/7/206-2> [Accessed 28 May 2018].
- Adetiloye, K. A. & Eke, P. O. (2014). A review of real estate valuation and optimal pricing techniques. *Asian Economic and Financial Review* [online], 4(12), pp. 1878-1893. Available from: [http://www.aessweb.com/pdf-files/aefr-2014-4\(12\)-1878-1893.pdf](http://www.aessweb.com/pdf-files/aefr-2014-4(12)-1878-1893.pdf) [Accessed 23 September 2018].
- Agarwal, S. (2007). The impact of homeowners 'housing wealth misestimation on consumption and saving decisions. *Real Estate Economics*, 35(2), pp. 135-154. DOI: 10.1111/j.1540-6229.2007.00185.x
- Aliyu, A. A. (2012). Impact of intangible location attributes on residential property value in Nigeria. Unpublished thesis (PhD). [online]. Nigeria: Abubakar Tafawa Balewa University. DOI: 10.13140/RG.2.2.17230.36167
- Australian Property Institute (API). 2015. *The valuation of real estate*. 2nd edition. Australia, Deakin West: API.
- Benitez-Silva, H., Eren, S., Heiland, F., & Jimenez-Martin, S. (2015). How well do individuals predict the selling prices of their homes? *Journal of Housing Economics*, 29, pp. 12-25. DOI: 10.1016/j.jhe.2015.04.001
- Blackledge, M. (2017). *Introducing property valuation*. 2nd edition. [e-book]. New York, NY: Routledge. Available from: Google Books <https://books.google.co.za/books?id=eFsPDQAAQBAJ&printsec=frontcover&dq=Introducing+property+valuation&hl=en&sa=X&ved=0ahUKEwieoITgyOzmAhXsTxUIHVetBgAQ6AEIKTAA#v=onepage&q=Introducing%20property%20valuation&f=false> [Accessed 28 May 2018].
- Carnoske, C., Hoehner, C., Ruthmann, N., Frank, L., Handy, S., Hill, J., Ryan, S., Sallis, J., Glanz, K., & Brownson, R. (2010). Developer and realtor perspectives on factors that influence development, sale, and perceived demand for activity-friendly communities. *Journal of Physical Activity and Health*, 7, pp. S48-S59. DOI: 10.1123/jpah.7.s1.s48
- Coffee, N. T., Lockwood, T., Hugo, G., Paquet, C., Howard, N. J., & Daniel, M. (2013). Relative residential property value as a socio-economic status indicator for health research. *International Journal of Health Geographics*, 12, 22. DOI: 10.1186/1476-072X-12-22

- Cordera, R., Chiarazzo, E., Ottomanelli, M., dell'Olio, L., & Ibeas, A. (2019). The impact of undesirable externalities on residential property values: spatial regressive models and an empirical study. *Transport Policy*, 80, pp. 177-187. Doi: 10.1016/j.tranpol.2018.04.010
- Drewnowski, A., Aggarwal, A., Rehm, C. D., Cohen-Cline, H., Hurvitz, P. M., & Moudon, A. V. (2014). Environments perceived as obesogenic have lower residential property values. *American Journal of Preventative Medicine*, 47(3), pp. 260-274. DOI: 10.1016/j.amepre.2014.05.006
- Dziauddin, M. F. & Idris, F. (2018). Assessing the relative importance of structural and locational effects on residential property values in Metropolitan Kuala Lumpur. *Pacific Rim Property Research Journal*, 24(1), pp. 49-70. DOI: 10.1080/14445921.2018.1436305
- Ferlan, N., Bastic, M., & Psunder, I. (2017). Influential factors on the market value of residential properties. *Engineering Economics*, 28(2), pp. 135-144. DOI: 10.5755/j01.ee.28.2.13777
- Forbes Real Estate Council. (2018). 11 Common misconceptions homeowners believe about selling their property. Forbes Real Estate Council, 26 January. [online]. Available from: <https://www.forbes.com/sites/forbesrealestatecouncil/2018/01/26/11-common-misconceptions-homeowners-believe-about-selling-their-property/#6605b40d20b7> [Accessed 28 May 2018].
- Henriques, A. (2013). Are homeowners in denial about their house values? Comparing owner perceptions with transaction-based indexes. Federal Reserve Board, Board of Governors of the Federal Reserve System Research Paper Series – FEDS Paper No. 2013-79. DOI: 10.2139/ssrn.2357665
- Kauko, T. (2006). Expression of housing consumer preferences: Proposition for a research agenda. *Housing, Theory and Society*, 23(2), pp. 92-108. DOI: 10.1080/14036090600773097
- Lin, I-H., Wu, C., & Sousa, C. D. (2013). Examining the economic impact of park facilities on neighboring residential property values. *Applied Geography*, 45, pp. 322-331. Doi: 10.1016/j.apgeog.2013.10.003
- Lundgren, B. (2013). Customer-perceived value in residential developments: the case of Hornsberg Strand, Sweden. *International Real Estate Review* [online], 16(1), pp. 1-27. Available from: [https://www.umac.mo/fba/irer/papers/past/vol16n1\\_pdf/01.pdf](https://www.umac.mo/fba/irer/papers/past/vol16n1_pdf/01.pdf) [Accessed 5 June 2018].
- Mackmin, D. (2008). *Valuation and sale of residential property*. 3rd edition. [e-book]. Oxon, OX: Routledge. Available from: Google Books <https://books.google.co.za/books?id=KWVTAQAAQBAJ&pg=PT174&dq=value+residential+property&hl=en&sa=X&ved=0ahUKewjm7L7VurfdAhXiAsAKHTtLA6lQuwUIVTAI#v=onepage&q=value%20residential%20property&f=false> [Accessed 1 April 2018].
- Matthews, J. W. & Turnbull, G. K. (2007). Neighborhood street layout and property value: The interaction of accessibility and land use mix. *Journal of Real Estate Economics*, 35, pp. 111-141. Doi: 10.1007/s11146-007-9035-9
- Oloke, O. C., Simon, F. R., & Adesulu, A. F. (2013). An examination of the factors affecting residential property values in Magodo neighborhood, Lagos State. *International Journal of Economy, Management and Social Sciences* [online], 2(8), pp. 639-643. Available from: <http://eprints.covenantuniversity.edu.ng/2207/1/51f9a0428c1515.70947613.pdf> [Accessed 1 April 2018].

- Rahadi, R. A., Wiryono, K. S., Koesrindartoto, D. P., & Syamwil, I. B. (2012). Relationship between consumer preferences and value propositions: A study of residential product. *Procedia - Social and Behavioral Sciences*, 50, pp. 865-874. DOI: 10.1016/j.sbspro.2012.08.088
- Romkaew, N. (2001). Evaluating the contribution of infrastructure effects on residential property. Unpublished Master's thesis. [online]. Melbourne Australia: RMIT University. Available from: [http://www.prres.net/papers/Romkaew\\_EVALUATING\\_THE\\_CONTRIBUTION\\_OF\\_INFRASTRUCTURE\\_EFFECTS.pdf](http://www.prres.net/papers/Romkaew_EVALUATING_THE_CONTRIBUTION_OF_INFRASTRUCTURE_EFFECTS.pdf) [Accessed 1 April 2018].
- Sánchez-Fernández, R. & Iniesta-Bonillo, M. Á. (2007). The concept of perceived value: a systematic review of the research. *Marketing Theory*, 7(4), pp. 427-451. Doi: 10.1177/1470593107083165
- Seo, W. (2018). Does neighborhood condition create a discount effect on house list prices? Evidence from physical disorder. *Journal of Real Estate Research* [online], 40, pp. 69-87. Available from: <https://aresjournals.org/doi/abs/10.5555/0896-5803.40.1.69> [Accessed 1 April 2018].
- Simo-Kengne, B. D., Bittencourt, M., & Gupta, R. (2012). House prices and economic growth in South Africa: Evidence from provincial-level data. *Journal of Real Estate Literature* [online], 20(1), pp. 97-117. Available from: <https://repository.up.ac.za/handle/2263/20396> [Accessed 1 April 2018].
- Teck-Hong, T. (2011)(a). Neighborhood preferences of house buyers: the case of Klang Valley, Malaysia. *International Journal of Housing Markets and Analysis*, 4(1), pp. 58-69. DOI: 10.1108/17538271111111839
- Teck-Hong, T. (2011)(b). The impact of neighborhood types on the prices of residential properties. *Sunway Academic Journal* [online], 7, pp. 77-88. Available from: [http://eprints.sunway.edu.my/87/1/Tan\\_Walter\\_-\\_final\\_edit\\_16\\_1\\_2011.pdf](http://eprints.sunway.edu.my/87/1/Tan_Walter_-_final_edit_16_1_2011.pdf) [Accessed 22 September 2018].
- Van der Crujisen, C., Jansen, D-J., & van Rooij, M. (2018). The rose-tinted spectacle of homeowners. *The Journal of Consumer Affairs*, 52(1), pp. 61-87. DOI: 10.1111/joca.12134
- Wang, Y, Po Lo, H., Chi, R., & Yang, Y. (2004). An integrated framework for customer value and customer-relationship-management performance: a customer-based perspective from China. *Managing Service Quality: An International Journal*, 14(2/3), pp. 169-182. Doi: 10.1108/09604520410528590
- Windsor, C., La Cava, G., & Hansen, J. (2015). Home price beliefs: Evidence from Australia. *Journal of Housing Economics*, 29, pp. 41-58. DOI: 10.1016/j.jhe.2015.05.002
- Zauner, A., Koller, M., & Hatak, I. (2015). Customer perceived value - Conceptualization and avenues for future research. *Cogent Psychology*, 2, pp. 1-17. Doi: 10.1080/23311908.2015.1061782
- Żróbek, S., Trojanek, M., Żróbek-Sokolnik, A., & Trojanek, R. (2015). The influence of environmental factors on property buyers' choice of residential location in Poland. *Journal of International Studies* [online], 8(3), pp. 164-174. Available from: [https://www.jois.eu/files/13\\_Zrobek.pdf](https://www.jois.eu/files/13_Zrobek.pdf) [Accessed 22 September 2018].



## HOUSEHOLDS' EXPOSURE TO INDOOR AIR POLLUTION FROM FOSSIL FUEL ELECTRIC GENERATOR USE IN MINNA NIGERIA

C. B. Ohadugha<sup>1</sup>, Y. A. Sanusi<sup>2</sup>, A. O. Sulyman<sup>3</sup>, B. N. Santali<sup>4</sup>, M. Mohammed<sup>5</sup> and S. O. Medayese<sup>6</sup>

<sup>1,2,3,4,5,6</sup> *Department of Urban and Regional Planning, Federal University of Technology, P.M.B. 65 Minna Niger State Nigeria.*

Lack of reliable access to modern energy in Minna Niger state results in households 'use of inefficient alternatives especially fossil fuel generators for domestic purposes. The study analyses indoor air pollution from households 'use of generator with a view to determining their exposure to Carbon monoxide. The concepts of energy access, poverty and generator pollution were reviewed. The research employed empirical approaches and adopted the multi-stage sampling technique. The study area has a population of 63,873 households. MSA Altair 5X Multigas detector was employed in the detection of pollution (CO) levels emanating from the generator use. It revealed that inefficient use of generator, generates 60 ppm, above the WHO and NAAQS threshold of 10 ppm. 66.4% of the generator using households are exposed to dangerous levels of CO pollution from generator use at  $\leq 4$  meters 'distance in Minna, Nigeria. The study concluded that households 'access to adequate electricity de-emphasizes the need for generator ownership and use. Households 'liveability is undermined by high level of pollution. It recommended enlightenment on the dangers of exposure to carbon monoxide and that generators should be operated at a minimum distance of 4 meters away from residential buildings.

Keywords: carbon monoxide, domestic energy, energy poverty, generator

### INTRODUCTION

Epileptic power supply is being experienced by households in Minna, the capital of Niger state the acclaimed 'power state 'of Nigeria. They barely experience 24 hours of uninterrupted power supply despite being the host state of three hydro power stations. This lack of steady electricity energy plunges the households into domestic energy poverty situation as most domestic activities requiring energy

<sup>1</sup> chuks@futminna.edu.ng +2348035904147

<sup>2</sup> yasanusi@futminna.edu.ng +2347063848372

<sup>3</sup> l.sulyman@futminna.edu.ng +2348033900864

<sup>4</sup> santali.aliyu@futminna.edu.ng +2348065354304

<sup>5</sup> mohammedmaikudi@futminna.edu.ng +2348036342228

<sup>6</sup> m.samuel@futminna.edu.ng +2348033033184

revolves around electricity energy. Power outage makes them vulnerable security wise especially at night. Increased households 'energy expenditure and pollution exposure is experienced when inefficient alternatives are used especially fossil fuel generators. The generators are majorly resorted to because apart from illumination that other inefficient alternatives can offer, they offer other services such as powering appliances. Fumes from generators contributes to climate change and most importantly increases morbidity and mortality rate through indoor air pollution. Households are at risk when generators are used inefficiently such as in the garage, veranda, balcony, unused rooms, etc. Therefore, the study analyses indoor air pollution associated with generator use in Minna Nigeria with a view to determining households 'exposure to carbon monoxide indoor pollution that will champion the need to play safe in the operations and use of fossil fuel generators.

## LITERATURE REVIEW

### Energy access

In spite of modern energy services being germane to both human and economic development, still electricity is not accessed by over 1.3 billion people (World Energy Outlook (2002). Electricity is needed for lighting, heating, boiling, and cooking and mainly for various domestic appliances operation. However, the inadequacy in generating electric power likewise poor distribution network has subjected a large chunk of the citizenry to inefficient alternatives of Portable Power Electricity Generator (PPEG), kerosene lantern and candle use for their domestic lighting needs. This, puts them at health risk and invariably increases their household expenditure (Ohadugha 2018). Globally, fossil fuel dependent economy and the greenhouse gas emissions increase is drastically changing the climate system and having a noticeable global impact (UNDP 2016).

Resulting from the epileptic nature of electricity supply, a great percentage of urban dwellers and also industries rely on electricity generating plants (Ladan 2013). The result is that operating of the generators has become a source of both indoor and outdoor air pollution in the urban centres. Quantities of smoke and particulates are generated when generators are inefficiently operated as result of the age, lack of maintenance and operational factors (Ohadugha 2018). On daily basis, average level of indoor emitted pollutants often goes beyond current World Health Organisations guidelines and acceptable levels of 9-10 parts per million (ppm).

**Table 1: Nigerian ambient air quality standard**

Air Pollutants	Emission Limits
Particulates	250 (µg/m <sup>3</sup> )
SO <sub>2</sub>	0.1 (ppm)
Non-methane Hydro carbon	160 (µg/m <sup>3</sup> )
CO	11-4 (µg/m <sup>3</sup> ) or 10 (ppm)
NOX	0.04-0.06 (ppm)
Photo chemical Oxidant	0.06 (ppm)

Source: Federal Ministry of Environment (FME, 1991)

In Nigeria, the ambient air quality maximum limit as approved by the Federal Ministry of Environment, Housing and Urban Development (FME & UD) is 10 ppm - 20 ppm for an average time of 8 hours (Abdulkarim et al. 1990). The WHO

standards in Table 1 were adopted as the national standards for residential buildings gaseous emissions against which air quality parameters monitored are compared in order to determine its "cleanliness" (Federal Ministry of Environment 1991).

### **Electric generator and air quality**

Electricity supply is one public service that has witnessed uncomplimentary remarks from both members of the public and policy analysts over the years and this has generated a series of adaptations including proliferation of private small electricity generating plants (Sanusi 2008). This leads to environmental pollution and increased greenhouse gases due to emissions.

The emissions emanating from Portable Power Electricity Generator (PPEG) has become a major indoor air pollution problem in the country and areas experiencing bad electric power situation (Adefeso et al. 2012). Using PPEG to make up for power shortages, owners most often operate them indoors or very close to their homes in response to generator theft and serene disturbance to neighbours (Ashmore and Dimitroulopoulou 2009). Furthermore, indoor levels of air pollutants can be increased by inadequate ventilation. Supporting the observation above, inadequate windows aggravate indoor pollutants accumulation (White and Marchant 2009). United States Consumer Product Safety Commission (US CPSC) reported that generator positioned near open windows, doors, or vents outdoors accounted for 4.8% deaths caused by generator carbon monoxide poisoning (Marcy and Ascon 2004). The carbon monoxide emission factor from PPEG's powered with gasoline was determined and was proved that carbon monoxide concentrations within enclosures dissipates quickly with high rate of air exchange and further concluded that PPEG should be placed above 10 meters away, if wind direction is towards the building (Adefeso et al. 2012).

Generator use impacts both negatively and positively (Ohadugha 2018). Negatively, the use of PPEG impacts on the health of both the users and those around it through the air pollution and noise. In Nigeria, households operate generators for six hours on the average daily (Stanley et al. 2010) with average distance of 5.6m from building contrary to 10m minimum proposed by Adefeso et al. (2012). Along with poor ventilation, these factors have negatively influenced households' indoor air quality implying that the households are exposed to some concentrations of carbon monoxide (Ladan 2013). The most commonly identified reasons of CO poisoning from PPEG in the observations of Hampson and Zmaef (2005) are ignorance of CO poisoning and ventilation requirements likewise operating generators indoor, especially in the garage. Accordingly, increase in indoor carbon monoxide level in India is attributable to PPEG use in their urban areas (Lawrence et al. 2004). In 2008 alone in Nigeria, more than 60 people suffocated to death resulting from the CO effects due to their exposure to its high concentrations (Adefeso et al. 2012). An individual's health condition, length of exposure as well as the CO concentration determines the health effects (Ohadugha 2018). The effects on people differ though dependent on the CO level and the individual peculiarities (WHO 2000).

## **MATERIALS AND METHOD**

### **Study area**

Minna doubles as the capital of Niger state and the headquarters of Chanchaga Local Government Area (Niger state statistical year book year 2011). Chanchaga Local Government Area is encapsulated by Bosso Local Government Area of Niger state. It lies between Latitude 9° 33' and 9° 40' North of the Equator and Longitudes 6° 29' and 6° 35' East of the Greenwich Meridian on a geological base of an undifferentiated basement complex of mainly gneiss and magnetite (Max Lock Nigeria Limited 1979). The state has an area of about 76,363km<sup>2</sup>. With Shiroro, Kainji and Jebba Hydro-Electric Dams of Nigeria located in Niger State, the state is the acclaimed "Power Generating House" of the Nigeria with the slogan "Power State".

### **Methodology**

This study analyses households' exposure to indoor air pollution which entails detecting and measuring the level of pollutants concentration indoors, specifically carbon monoxide resulting from domestic use of electric generators. The research is a household and empirical survey as both primary and secondary data were sourced using semi structured questionnaire from the eventual randomly selected households. Also, portable hand-held gas detector/monitor (MSA Altair 5x Multigas Detector) was used to detect and capture carbon monoxide concentration in the generator using households while the generator is running irrespective of the reason for using generator.

The analysis was done with Statistical Package for the Social Sciences (SPSS) as a tool. In order to examine households' exposure to indoor pollution induced by generator use in Minna, the generators mode of use was examined. Gas concentrations indoors were discerned using MSA Altair 5X Multigas Detector which aided determining the level which urban residents are exposed to indoor pollution in the study area. The MSA Altair 5X Multigas Detector Version: SW 1.27.06.50 S/N: 0056759 manufactured by Mine Safety Appliances Company; 1000 Cranberry Woods Drive Cranberry Township, PA 16066 USA is a portable hand-held device used to measure the concentration of gases in the environment. The device is available with a maximum of four sensors, which can display readings for five separate gases (one Dual Toxic Sensor provides both CO and H<sub>2</sub>S sensing capabilities in a single sensor), Oxygen (O<sub>2</sub>) and 2 combustible gases including Pentane.

### **Population and sampling technique**

The 2018 projected population of the study area which is 319,366 and with national household size average of five (<https://dhsprogram.com/pubs/pdf/FR148/02Chapter02.pdf>) resulted to approximately 63,873 households.

Using online sample size calculator with confidence level of 95% and 5% margin of error, the sample size is 382. Extra 18 questionnaires were added to make up for possible unanswered rounding it up to 400. Eventually, they were all correctly filled and returned. Hence, 400 copies of the research instrument were proportionally distributed to households in the neighbourhoods making up the study area according to their population. Multi-stage sampling technique involving clustering



(neighbourhoods), stratifying (residential houses) and purposive randomising (households using generators) was adopted for the study in selecting the sampled units.

## RESULTS AND DISCUSSION

This section evaluates households 'exposure to indoor pollution in Minna metropolis. It involves analysing the generator use, operating position and distance and their emission (carbon monoxide concentration) to determine the safety or otherwise of the households.

### Alternative lighting energy

With the incessant power outage experienced in the study area, the primary domestic energy types used for lighting during power outage include solar, inverter, generator, kerosene lantern, rechargeable lanterns, torchlight and candle. For the purpose of the study which involves pollution, generator was considered. Other prevalent pollutant emitting lighting energy types such as candles and kerosene lanterns with average CO emissions of 2 ppm and 1 ppm respectively were not considered because their emissions are very minimal to endanger human health.

### Emission from lighting devices

There are varying CO emission levels from the 'dirty 'alternative lighting fuel households use in times of power outage. As shown in Plate I, a candle stick measuring 19cm (length); 1.5cm (base diameter) and 1cm (tip diameter) burned for 3 hours in an enclosure (windows and door closed) with average carbon monoxide concentration of 2 ppm.

With the same specification of candle but in an opened enclosure (windows and door opened), the candle burned for 2 hours 45 minutes and yielded zero emission. The implication is that candles, in terms of carbon monoxide emission are safer than generators that are used inefficiently though they are rarely used because of the low illumination and the risk of fire hazard if not administered properly.

Similarly, kerosene lantern used by 1.3% of the households observed for one hour emits an average carbon monoxide emission of 1 ppm.



Plate I: Measuring CO Emission from Candle  
Source: Authors 'field work, 2018.



Plate II: Observing CO level

Generators come in various sizes and capacities but the commonest in use is the TG950 model (I pass my neighbour) because it is more affordable and portable to most urban residents. Also of interest is its operating principle regarding emission

because engine oil is added to the petrol which aggravates emission of carbon monoxide. Equally, its size makes it flexible position-wise as it can be adjusted at will. For example, bringing it closer or even within the dwelling corridors and veranda during adverse weather conditions such as rain.

The research adopted two scenarios to represent the generator operating position within and outside dwellings. Observing CO level in an indoor environment (worst-case scenario) was done in a 400 m<sup>2</sup> hall where a TG950 model (I pass my neighbour) generator was used alongside measuring tape and a gas detector (Plate II).

The generator is placed at the centre of the hall and the readings were recorded at an interval of one meter up to ten meters distance from the generators four sides. This was done to observe possible variations in the readings. The measurement range of 1 - 10 meters as depicted in Table 2 was based on the assumption that generators placed above 10m has minimal adverse impact in terms of air pollution.

**Table 2: Varying carbon monoxide concentration from a generator in an enclosure**

Distance (m)	Side A	Side B	Side C	Side D	Avg conc/dist (ppm)
1	125	25.2	62.4	87.2	74.95
2	68.6	20.4	59.4	88	59.1
3	50.6	16	53.2	99	54.7
4	50.4	26.4	58	110.2	61.25
5	51.8	27.6	57.8	108.8	61.5
6	21.4	29.6	58.6	114.2	55.95
7	4	32.4	69.2	118.6	56.05
8	4	37.2	65.2	120.2	56.65
9	6	36.6	72.6	124.2	59.85
10	24.8	39	60.2	123.8	61.95
Avg conc/ side	40.66	29.04	61.66	109.42	60.19

Source: Authors 'field work, 2018.

As shown in Table 2, it was discovered that at one meter away from the exhaust pipe side, the CO concentration was highest at 125 ppm and the side adjacent to the exhaust pipe has the overall highest CO level. The mean emission is observed to be approximately 60 ppm.

For the best-case scenario (out-door), the generator is placed with the exhaust pipe directed away from building openings (windows and doors) at intervals of one meter up to ten meters and gas detector readings indoors were recorded. The result of the observation in both best- and worst-case scenarios (out-door and in-door) at distances of one meter to ten meters from the source point is shown in Figure 1. In the same way, for in-door environment, the generator was at the centre of the hall from where measurements were taken from the exhaust pipe direction, opposite and both adjacent directions. The indoor environment result is the average of the results from the four directions of the source point.

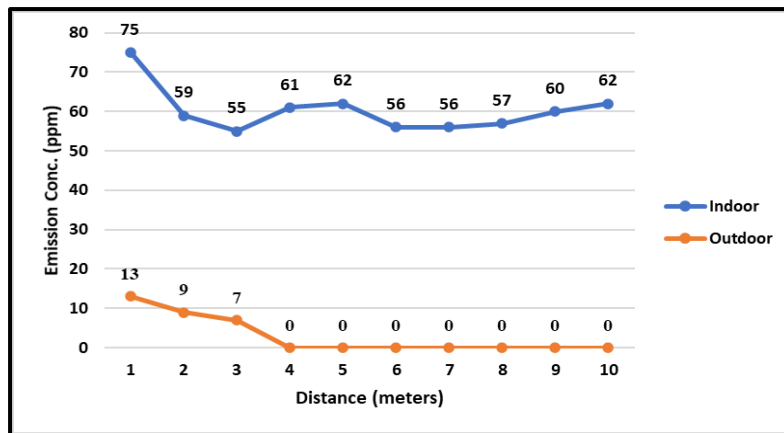

Figure 1: Average concentration levels at various distances in both scenarios  
 Source: Authors 'field work, 2018.

Apart from indicating the various concentration levels at various distances in both scenarios, Figure 3 also shows that from the source point in an enclosed environment, the concentration fluctuates as the distance increases but rises at the extreme (wall barrier). It was also observed that wind (speed and direction) influences emission concentrations levels. The indoor experience implies that operating generators within the buildings is a health risk because emissions within the dwelling build up to dangerous levels.

**Generator operating positions and distances**

Portable Petroleum Electricity Generators (PPEG) are operated from varying positions and distances during power outages. From the survey, the generator operating positions were identified and classified in Table 3 as follows: Generator house – enclosure purportedly built for generators to be operated from; outside the building (dwelling) – open operating position outside the dwelling from varying distances dependent on the convenience of that position and; within the building – operating positions under the same dwelling roof such as corridors, underutilized rooms, verandas, balconies, in-built garages and in tangent to dwelling walls.

**Table 3: Generator operating position**

Generator Position	Frequency	Percentage
Generator house	59	23.6
Outside the Building	148	59.2
Within the building	43	17.2
Total	250	100

Source: Authors 'field work, 2018.

Out of the generator users, 23.6% operate their generators from generator house, 17.2% within the dwellings such as in the corridors, verandas, lobbies and unused rooms within the building while 59.2% operate PPEGs outside the dwellings from various distances. It is worthy of note that distance wise, those PPEGs operated from purposeful generator houses are assumed to be safe in terms of indoor pollution while those operating within the buildings are assumed to be at zero distance. Generators operated within and outside the dwellings apart from generator houses are the bases for the analysis.

Based on the worst-case scenario observations stated earlier, 17.2% of the households that operate their PPEGs within the dwellings are at risk of greater exposure to carbon emission from generating plants. From the enclosed environment, carbon monoxide concentration observed from the study recorded an average of 60 ppm. For a minimum of 30 minutes exposure with such concentration, symptoms of headache and dizziness would be experienced by the occupants and would tend to a hazardous level for 8 hours exposure (Goldstein 2008; Struttmann et al., 1998). This result suggests that 66.4% generator using households representing 41.5% of the entire households in the study area are exposed to hazardous level of PPEG induced indoor pollution.

The observations further revealed that generators placed at 4 meters away from dwellings with other conditions met, zero (0 ppm) carbon monoxide concentration was recorded. It is imperative to reiterate the conditions to include; air/wind influence, exhaust pipe directed away from dwelling openings and against the wind direction. These conditions especially the wind influence in terms of speed and direction are major constraints to the record taking. This was addressed by taking measurements at intervals and eventually using their average.

In summary, Figure 2 reveals that 66.4% of the generator using households are at great risk of exposure to indoor pollution as they operate their PPEGs within the observed generator operating distance of less than or equal to 4 meters. This represents 41.5% of the entire households in the study area.

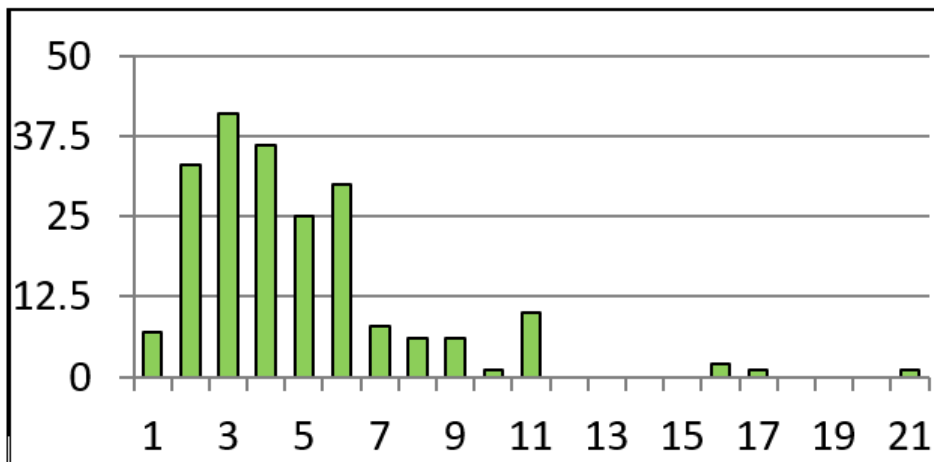

Figure 2: Dangerous Generator Operating Distance  
Source: Author's field work, 2018.

Generator use characteristics as observed by the survey vary as such variations are indicators of how safe or not households are in terms of emission exposure with reference to generator operating distances outside the dwellings. The analysis is based on the observed safe operating distance of 4 meters in Minna metropolis. The study discovered that 66.4% of the households using generator as their primary lighting energy type are at risk of emission exposure based on 4 meters generator safe operating distance from houses.

## CONCLUSION AND RECOMMENDATIONS

Promoting access to electric power in particular is a very important dimension to consider in enhancing households' access to energy. Poor accessibility to modern energy is the main rationale for households' reliance on pollutant emitting domestic lighting energy types that endangers their health through indoor pollution. It could be deduced that neighbourhood quality and liveability is undermined by the extensive and high level of pollution. Abnormal use of PPEGs such as its proximity to building openings, faulty and subserviced plants, positioning the exhaust pipe against wind direction also aggravates morbidity rate of households through indoor pollution.

In order to improve both human and environmental health likewise reducing dependence on emission generating domestic lighting energy sources in Minna metropolis, the study recommends operating generators above 4 meters away from users and dwellings and ensuring compliance to reduce pollutants concentration. Also, enlightenment on the dangers of exposure to carbon monoxide is imperative likewise encouraging installation of affordable carbon monoxide detector(s) in homes. This alerts the households when carbon monoxide level exceeds safe limit of 9 ppm.

## REFERENCES

- Abdulkarim, B. I., Chiroma, T. M., & Joseph, T. (1990). Assessment of CO, CO<sub>2</sub> and Suspended Particulate Matter Emissions. [http://lejpt.academicdirect.org/A11/109\\_116.htm](http://lejpt.academicdirect.org/A11/109_116.htm) WHO offset Publication, Geneva, 1990. p9.
- Adefeso, I., Sonibare, J., Akeredolu, F., & Rabiu, A. (2012). Environmental Impact of Portable Power Generator on Indoor Air Quality, 33 pp60–5. Int Conf on Env, Energy and Biotech IPCBEE 33 (2012)
- Ashmore, M. R., & Dimitroulopoulou, C. (2009). Personal exposure of children to air pollution. *Atmos Env.* 2009, 43: pp128-141.
- Federal Ministry of Environment (1991). Guidelines and Standards for environmental pollution control in Nigeria.
- Goldstein, M. (2008). Carbon monoxide poisoning. *J of Emergency Nursing: JEN* 34 6: pp538–542. doi:10.1016/j.jen.2007.11.014. PMID 19022078.
- Hampson, N. B., & Zmaeff, J. L. (2005). Carbon monoxide poisoning from portable electric generators. *AJPM* 2005 Jan; 28 1:pp123-5. <https://dhsprogram.com/pubs/pdf/FR148/02Chapter02.pdf> Retrieved on 2/9/18
- Ladan, S. I. (2013). Examining Air Pollution and Control Measures in Urban Centres of Nigeria, 4 6, pp621–8.
- Lawrence, A. J., Mashi, A., & Taneja, A. (2004). Indoor/Outdoor relationship of carbon monoxides and oxides of nitrogen in domestic home with roadside, urban and rural locations in a central India region. *Indoor Air.* 2004, 15: pp76-82.
- Marcy, N. E., & Ascon, D. S. (2004). Memorandum: Incidents, deaths, and in-depth investigations associated with carbon monoxide from engine-driven generators and other engine-driven tools, 1990-2004. Bethesda, MD, US CPSC 18.
- Max Lock Nigeria Limited (1979). "Minna Master Plan". Minna: Max Lock Nigeria Limited

- Niger state statistical year book year (2011). State Bureau of Statistics Niger State Planning Commission
- Ohadugha, C. B. (2018). 'Analysis of Domestic Energy Poverty and Exposure to Indoor Pollution Among Urban Households in Minna Nigeria'. An unpublished Ph.D Thesis submitted to the Fed Uni of Tech, Minna Nigeria
- Sanusi, Y. A. (2008). Service Security in Gbazango Residential Area of Kubwa, FCT Abuja. URP Conf Proc 1 1: pp136 -144
- Struttman, T., Scheerer, A., Prince, T. S., Goldstein, L. A. (1998). "Unintentional carbon monoxide poisoning from an unlikely source". JABFM 11 6: pp481–4. doi:10.3122/jabfm. 11 6. 481. PMID 9876005.
- White, L., & Marchant, P. (2009). An Overview of Residential Indoor Air Problems. Dept of Health, Washington.
- WHO (2000). Carbon Monoxide. Chapter 5 Air Quality Guideline 2nd Edition. WHO Regional Office for Europe, Copenhagen, Denmark, Retrieved on 22/8/15 from [http://www.euro.who.int/data/assets/pdf\\_file0020/123059/AQG2ndEd\\_5\\_5\\_carbonmonoxide.pdf](http://www.euro.who.int/data/assets/pdf_file0020/123059/AQG2ndEd_5_5_carbonmonoxide.pdf)
- World Energy Outlook (2002). Energy and Poverty. Chapter 13; World Energy Outlook Series. International Energy Agency
- UNDP 2016. Goal 7: Affordable and clean energy. Retrieved online from <http://www.undp.org/content/undp/en/home/sdgooverview/post-2015-development-agenda/goal-7.html> on 8/3/2016.



## HOUSING AFFORDABILITY IN OSOGBO OSUN STATE NIGERIA

Akinremi Adenike R.<sup>1</sup>, Adedayo Adeyanju G.<sup>2</sup>, Saheed Jelili<sup>3</sup>, Yussuf Shakirat O.<sup>4</sup>  
and Ojo Omotayo Mubo<sup>5</sup>

<sup>1,3,5</sup>*Department of Estate Management Osun State College of Technology, Esa-Oke, Nigeria.*

<sup>2</sup>*Department of Estate Management Federal Polytechnic Ede, Osun state, Nigeria.*

<sup>4</sup>*Department of Architectural Technology Osun State College of Technology, Esa-Oke, Nigeria.*

The aim of this study is to determine housing affordability in Osogbo using Olorunda local government area as case study. Survey research design was adopted and data were collected from both primary and secondary data, primary data were gathered by administering structure questionnaires to 343 owners – occupiers and rentals. Random sampling technique was adopted in administering the questionnaires, The Pearson Product Moment Correlation and Regression involving dummy variables (logit model) was used to test the stated hypothesis. Findings show that the rate at which rent on houses and the cost of building houses did not correspond to the rate at which salaries/incomes of household increases. Only 37 (10.8%) earns above #200,000. the cost of construction is above #5m, 39(21.4%).73 (45.1%) of the respondents paid between #5,000 and #15,000 rent every month. Majority of the people find themselves living in houses that do not reflect their social economy status, furthermore, 17.8% of the residents are left with 20% to 29% of their income after paying their rent, this study reveals that more than 30% of their income is spent on housing indicating that housing are not affordable this shows that there is a positive relationship between construction cost and capital value (.384 < 0.05), the simple Regression analysis shows that the overall level of explanation of expenditure by income is 85% (r<sup>2</sup> of 0.85). The income of respondents is not sufficient to pay the rent for decent houses, thus housing is unaffordable. Government should adopt policies that will increase the mobilization of housing finance system for the provision of affordable houses.

Keywords: affordability, housing, income, occupiers, rent

### INTRODUCTION

Housing is the basic need of man which is fundamental to the welfare, survival and health of individuals (Aribigbola, 2011).It has been a major priority to the government. Since independence, various housing programme and policies was

<sup>1</sup> akinremiadenike@gmail.com; +2348034665908

<sup>2</sup> graceadedayo@gmail.com; +2348060251434

<sup>3</sup> jelilisaheed55@gmail.com; +2348038534067

<sup>4</sup> shakiratyussufmohammed@gmail.com; +2347035095280

<sup>5</sup> tayolase@gmail.com; +2348033798870

enacted by the government to see that adequate and affordable housing units are provided for the masses. The effort of the government in production of housing units was not sufficient enough to meet the housing need of the growing population as a result of urbanization. In order to address this issue, the private sector also have been key players in meeting the nation's housing need by providing housing units but majorly for the medium and high income earners because of the cost of the housing units This is attributed to high rise of cost of building materials, inflation rate, high space and quality standard adopted by designs, fess of professionals involved design and construction, excessive profit of contractors and developers (Sadou, 2019). Efforts of households especially the low income earners to meet up with their housing obligations have been jeopardized due to high cost of housing. Thus majority of their incomes are spent on housing while other needs are greatly affected. Housing affordability is subject to the income of the household with respect to the housing price. The complexity in housing affordability required more consideration beyond mere economic viability to include life quality and well-being of households. (Anthonia, 2019).This study, therefore, examines the housing affordability in Olorunda local government area of Osogbo in Osun Towards this broad goal, the specific objectives are to:

1. Determine access to owner-occupied and rental house;
2. Examine the income level of the residents in relation to housing consumption;
3. Assess the relationship between rental value and level of affordability;
4. Assess the experience of low-income households in acquiring (un)affordable housing;
5. Identify problems associated with housing affordability.

## CONCEPTUAL FRAMEWORK AND LITERATURE REVIEW

In early times, housing has been recognized as one of man's basic needs and access to housing is an important factor in maintaining and improving the quality of life as well as an essential component of the society. (Ghilenca, 2019). Housing connotes a physical structure which serves as domicile of man's activities and it is widely recognized as a human right. In Nigeria, low income households struggle when it comes to finding adequate shelter that does not leave them in financial difficulty (Adegun,2019).The gap between the supply and demand of housing have led to acute shortages thereby resulting in high property values, unaffordability and overcrowding. Most people cannot afford to pay rent or own their desired homes due to income limit.(Anthonia et,2019).Affordability is concerned with the securing some given standard of housing or different standard at a price or rent which does not impose an unreasonable burden on household incomes.(HUD,2005)

Jingchun (2011), gives the characteristics of affordable housing as follows;

- I. Government involving as the main provider of affordable housing is not commercial real estate developer but the government affordable housing project is planned by the government including the location, housing type, building standards and the level of house price.



- II. Consumers are fixed. There is limitation for affordable housing consumers, like low-income crowd. Government has the principles for affordable housing purchase like family members, income level and background. It should be noted that affordable housing market is opened to specific consumers.
- III. Complicated applicant selection. That is the number of affordable housing supply is less than the demand, because if the supply is higher than the demand, it will make the price to fall thereby affecting the commercial housing market.

Ankeli, Dabara, Oyeleke, Joshua & Eytayo (2015) confirmed that most families in Nigeria cities spends over 50% of their annual income on housing rents owing to lack of property availability, infrastructural services, location etc. but. Right to adequate affordable housing is an important component of standard of living as well as social and economic investment to individual, family and the community at large (Babatunde, 2017). Affordable housing was also recognized by the United Nations as a fundamental human rights (Luminita et, 2020). The housing price in most of the cities in Nigeria are very high due to the abnormality in the cost per unit of a building, cost of construction materials and technology. Few people are able to afford it This resulted into a wide gap between income and shelter. (Adegan, 2019). People are also faced with financial constraint and difficulty to obtain housing loans to get their own accommodation, (Norhasiliya et, 2017). The socio economic characters of low income civil servants, their housing choice and individual preferences are some of the factors that significantly influence affordability level (Adeleye et 2016). This is an indication that housing affordability has to do with housing cost in relation to income. The Nigerian urban market primarily target high income earners and thus leaves larger parts of Nigerians population excluded from formal housing provision. Anthonia, (2019), stated that the availability of affordable housing in the developed countries contributes to the achievement of house ownership which directly relieves household from stress but aiding quality of life and sustainable development plans. But this is not the situation in Nigeria (Balchin et 2001), revealed that in countries like Latin America, there is scanty research in affordable housing due to minimal affordability and limited investment in social housing.

Factors accounting for housing unaffordability are unstable employment, income inequality and living condition (Jing, 2014). In 2011, Meen introduced long-run Eco metric model to evaluate the impacts of different levels of housing construction on affordability these includes housing price, household formation, housing tenure, migration, demograph and labour. Pualetic (2017), considered that for housing to be affordable, it should not exceed three times the gross annual household income.

The purpose of housing affordability is to assist the low income households (McClure, 2019) but reduction of fees and the Developers profit has been a challenge.

## RESEARCH METHODOLOGY

This study will use both primary and secondary data in order to get relevant information on housing affordability.

### Primary data

Reconnaissance survey was carried out in the study area in order to get familiarized with the area; residents of the area were interviewed on housing and rate of affordability. Structured questionnaire was administered to the respondents in order to get information on their socio-economic status, assessment of the dwellings, facilities and services provided, rate of housing construction, cost of construction, and the persisting rent problems of the study area.

### Secondary data

The secondary sources of data for this research includes review of literature, from published materials like textbooks, Journals, Published information in annuals and other reports are consulted which revealed the existing literature relevant to this research. Unpublished materials like papers presented at conferences, seminars and workshops and dissertations from library were used. Moreover, relevant rating documents of Valuation department of Olorunda LGA was used to know the numbers of housing units in the area, Osun State Ministry of Lands and Physical Planning and Town planning department of Olorunda Local Government were also visited in order to collect the database maps of Osun State and that of Olorunda Local Government.

### Sample frame, sample size and sampling procedure

Olorunda Local Government is one out of the two local Governments in Osogbo. The local Government comprises of seventeen (17) zones which was demarcated into three residential densities as shown in the table below.

**Table 1. Selected zones in Olorunda Local Government Area**

s/n	Zone	Streets	Density	No. of houses (Sample Frame)	Sample Size at 8 %
1	A	Ajegunle, Agowande	Low	158	13
2	B	Agowande, Olatunji, Oke Oniti, Igbona	Medium	316	25
3	C	Olunsogo, Church St, Owoeye, Dejo Babalola, Ikirun Rd., Elebolo, Irewole, Oke Oniti, Ayedun, Fadesere, New Ikirun Rd.	Medium	312	25
4	D	Salako, Alh. Ajadi Aresa, Power Line, Beside Ajewole, Ota efun.	Low	149	12
5	E	Ota efn, Dejo Kolawole, Odunade Adesina, Kobongboge	Low	75	6
6	F	Camp, Off Gafar, Olabiyi, New Ikirun, Off New Ikirun, Alabameta, Otaefun/Kobongboge	Low	181	15
7	G	New Ikirun Rd., Powerline, Testing ground, Opp Powerline, Old Ikirun Rd.	Medium	322	26

**Table 1 Cont'd. Selected zones in Olorunda Local Government Area**

8	H	Ayetoro, Kolabalogun, Oke Ayo, Pepsi Cola, Omo west Area.	Medium	387	31
9	I	Testing Ground, Kolabalogun, Old Ikirun Rd., Sabo, Olorunosebi, Off Irepodun.	Medium	382	31
10	J	Sabo, Atelewo, Kolawole, Arikalamu, Oluode, Agana, All Saint Church, Elebolo, Abija, Oleyo Olayinka, Akojun.	High	823	66
11	K	Awolowo way, Abaku, Tewogade compd. Owo Ope, Ebolobi compd. Sabo	Medium	229	18
12	L	Igbona, Ayetoro, Obadio, Agaana, Sabo	Medium	232	19
13	M	Owode	Low	74	6
14	N	Oluode, Owode, Balogun, Station Rd., Gbemu	Medium	292	23
15	O	Latona, Ajegunle, Bishop, Asipa, Oke Oniti	Low	176	14
16	P	Okefia, Adesina Amo, Ilobu Rd.	Low	57	5
17	Q	Sabo, Atelewo	Low	97	8
		Total		4,262	343

Source: Estate and Valuation Department, Olorunda Local Government, 2021.

### ***Sampling procedure***

Time and resources limitation made a comprehensive survey of all zone in Olorunda Local Government unpractical. Therefore, random sampling technique was adopted for the purpose of administering the questionnaire. At the first stage, all zones that fall within the local government were identified. These are zones A to Q. At the second stage, the streets and densities were identified as shown in Table 1 above. With the view of taking samples from the zones at the third stage, the researchers selected all the zones, and sampling ratio was used to determine the sample size. The total number of the residential properties in the zones was four thousand two hundred sixty two (4,262), the researchers used a sampling ratio of eight (8) percent. This is based on Neuman's (1991; 2004) assertion that larger population permit smaller sampling ratio for equally good samples. Using the sampling ratio of 8 percent, the sample size obtained stood at three hundred and forty three (343) while the sample frame was 4,262 the breakdown of respondents for selected zones is contained in Table 1 above.

Finally, at the fourth stage, the researcher used systematically selected appropriate number of households from the streets. In other words systematic sampling technique was used to select buildings from the streets. In all, a total of 343 questionnaires were adequately administered.

### ***Research design and methods***

The data was collected from the residents through the questionnaire. Appropriate statistical techniques including frequency tables and percentages were used to explain the results of the study. The ANOVA test of independence was used to ascertain the relationship between monthly income and housing affordability in the study area.

## THE STUDY AREA

Olorunda Local Government council area is one of the thirty (30) LGAs that constitute the present Osun State. It is bounded on the East by Irepodun Local Government/ Surulere Local Government of Oyo state, Osogbo Local Government on the West, Ifelodun/Boripe and Egbedore on the North and South respectively. The Local Government Area covers an area of about 600 square kilometers.

Igbona, in Osogbo Township, which is the administrative headquarter of the LGA lies on Latitude 70471 North of the Equator and Longitude 40331 of the Greenwich Meridian. It lies within the rainforest area that spreads towards the grassland belt of Ikirun with an annual rainfall of about 0.6 meters. The rainy season begins in March and ends in September or early October. The harmattan or dry season begins in October and ends in March. The climate is less humid although the effects of the harmattan winds are strongly felt in the dry season. The population of Olorunda Local Government as revealed by the National Population Commission provisional result of 1991 was put at 83,347. The distribution of 1991 population census shows that part of the Osogbo township of Olorunda Local Government accommodates about 83.5% of the population, Oba-Ile, another town in the Local Government has about 4.2%, Oba-Oke 4.4%, Ilie 2.7% and the remaining 5.2% is shared among the remaining villages and hamlets in the Local government.

## DATA ANALYSIS AND RESULT

This study examined the housing affordability in Olorunda local government Osogbo, Osun state. The following information were gathered and analyzed from the respondents as shown in the tables below:

**Table 5.1: Rented apartment**

Household resident	Frequency	Percentage
Yes	162	47.2
No	181	52.8
Total	343	100.0

Source: field survey, 2021.

From table 5.1, 47.2% of the respondents lived in rented by saying yes. 52.8% of the respondents did not live in rented resident, but owner occupied.

**Table 5.2: Rent payable (monthly)**

Rent (N)	Frequency	Percentage
<5000	35	21.6
5000-15,000	73	45.1
15,000-30,000	34	21.0
>30,000	20	12.3
No response	181	0.0
Total	343	100.0

Source: field survey, 2021.

Table 5.2 revealed that 35(21.6%) paid below N5000. 73 (45.1%) of the respondents paid between N5000-N10, 000 as rent. 34(21.0%) of the respondents paid between 10,000 to 20,000. 20 (12.3%) of the respondents paid above N20, 000 as rent.

**Table 5.3: Level of the rent**

Level of rent	Frequency	Percentage
Fairly high	42	25.9
High	56	34.6
Exorbitant	26	16.0
Moderate	38	23.5
No response	181	0.0
Total	343	100.0

Source: field survey, 2021.

Table 5.3 indicated that 42 (25.9%) of the respondents consider the rent paid has fairly high, 56(34.6%) considered the rent paid to be high, 26(16.0%) of the respondents considered it to be exorbitant, 38 (23.5%) of the respondents considered the rent to be moderate.

**Table 5.4: Causes of high rent**

Causes of high rent	Frequency	Percentage
Landlord decision	79	23.0
High demand	87	25.4
Increase in the number of people	92	26.8
Employment opportunities	46	13.4
Location	39	11.4
Total	343	100.0

Source: field survey, 2021.

Table 5.4 indicated the causes for high rent in the study area. 79(23.0%) of the respondents gave the reason that the landlord increases the rent intentionally, 87(25.4%) of the respondents gave the reason to be the number of people demanding for housing units in the area. 92(26.8%) of the respondents gave the reason to be the influx of the people to the study area, 46(13.4%) gave the reason to be as a result of employment opportunities while the remaining 39(11.4%) of the respondents gave the reason for rent increase to be location.

**Table 5.5: Cost of construction**

Cost (N)	Frequency	Percentage
1m-2m	13	7.2
2m – 3m	25	13.8
3m – 4m	48	26.5
4m – 5m	56	30.9
> 5m	39	21.5
No response	162	0.0
Total	343	100.0

Source: field survey, 2021.

Table 5.5 shows that 13(7.2%) used below 1m to build their houses, it costs between 1m -2m 25(13.8%) of the respondents to build their houses, 48(26.5%) of the respondents used between N3m -4m to build their houses. It cost 3(21.5%) of the respondents above 4m to build their house.

Table 5.6 indicated that 20(5.8%) of the respondents has their housing market value below N500,000, 36(10.5%) of the respondents has their housing market value between N500,000-N1000000, 68(19.8%) has their housing market value to be between N1000000-N1500000, 83 (24.2%) has their housing market value to be

between N200000-N25000000 while the remaining 136(39.7%) of the respondents have their housing market value to be above N25000000.

**Table 5.6: Housing market value**

Market value (N)	Frequency	Percentage
2m – 4m	20	5.8
4m – 6m	36	10.5
6m – 8m	68	19.8
8m – 10m	83	24.2
<10m	136	39.7
Total	343	100.0

Field survey, 2021.

**Table 5.7: Development period (years)**

Development period (years)	Frequency	Percentage
< 5	66	19.2
5 – 10	34	9.9
> 10	81	23.6
No response	162	47.2
Total	343	100.0

Source: field survey, 2021.

Table 5.7 revealed that 66(19.2%) of the respondents built their houses under 5 years, 34(9.9%) uses above 10 years to build their houses while 162(47.7%) are not sure of the period because they are tenants as indicated in table 5.7 above.

**Table 5.8: Sources of fund for development**

Sources	Frequency	Percentage
Borrowing / loan	45	13.1
Profit from business	35	10.2
Salary	61	17.8
Others	40	11.7
No response	162	47.2
Total	343	100.0

Source: field survey, 2021

Table 5.8 shows that 45(13.1%) of the respondent borrowed or took loan for development of their houses, 35(10.2%) got their fund from their business profit, 61(17.8%) are those that uses the salary for housing construction while 40(11.7%) did not indicate how they get money for development and 162(47.2%) of the respondent are without response to the question because they are tenant which is in table 5.8 above.

**Table 5.9: Effects of housing construction on livelihood**

Effects	Frequency	Percentage
Yes	185	55.1
No	154	44.9
Total	343	100.0

Field survey, 2021.

Table 5.9: indicated that 185 (55.1%) of the respondents say yes that the housing construction has effects on their livelihood while the remaining 154 (44.9%) says no that the housing construction did not have effect on their livelihood.

**Table 5.10: Completion of the house**

House completion	Frequency	Percentage
Yes	229	66.8
No	114	33.2
Total	343	100.0

Field survey, 2021

Table 5.10 revealed that 229 (66.8%) of the respondents say yes that they have completed their buildings while 114(33.2%) say no they have not completed their buildings.

**Table 5.11: Causes for delay**

Causes	Frequency	Percentage
Low income	130	37.9
Family needs	107	31.2
Bad economy	78	22.7
Others	28	8.2
Total	343	100.0

Field survey,2021.

It was discovered during the survey that 37.9% of the respondents had delay in completing their houses due to low-income, 31.2% were delayed due to pressing family needs, 22.7% had delay due to bad economy while the remaining 8.2% of the respondents cannot actually give any reason for to delay in completion of their buildings.

**Table 5.12: Remedies for the high rent**

Remedies	Frequency	Percentage
Provision of affordable housing	98	28.6
Reduction in price of building materials	76	22.2
Eradication of caretaker	69	20.1
Development or rural areas	72	21.0
Others	28	8.2
Total	343	100.0

Source: field survey, 2021

In respect to table 5.12, the remedies given by the respondents indicated that 98(28.6%) of the respondents says that provision of affordable housing will solve the problem of high rent, 76(22.2%) gave the remedy to high rent as reduction in price of building materials. 69(20.1%) of the respondents say caretakers should be eradicated. 72(21.0%) of the respondents suggest that the rural areas should be developed while others 28(8.2%) of the respondents did not give any remedy for reduction in house rent.

**Table 5.13: Does rent equalize facilities available**

Responses	Frequency	Percentage
Yes	61	17.8
No	101	29.4
No responses	181	52.8
Total	343	100.0

Source: field survey, 2021

Table 5.13 revealed that 61(17.8%) of the respondent said that rent paid is equal to facilities provided in their houses while 101(29.4%) said no that rent is above the facilities provide which affordability problem. And 181(52.8%) are not tenant.

**Table 5.14: Percentage of income left after paying house rent**

	Frequency	Percentage
<20%	19	5.5
20-29%	61	17.8
30-39%	55	16.0
≥40%	27	7.9
No response	181	52.8
Total	343	100.0

Source: Field survey, 2021

From the above table, 19 (5.5%) of the respondents said that less than 20% of their income is left,, 61 (17.8%) said 20-30% while 27 (7.9%) said they are left with greater than or equal to 40% of their income but the remaining 181 (52.8%) of the respondents did not give answer to the question because the belief it is personal to them.

**Table 5.15: Profile for housing value**

Profile	Frequency	Percentage
Moderate	92	26.8
High	108	31.5
Very high	69	21.1
Exorbitant	74	21.6
Total	343	100.0

Field Survey, 2021.

From the field survey, 26.8% of the residents considered the profile for housing value to be moderate, 31.5% considered it to be high 20.1% considered it to be very high while the remaining 21.6% of the resident consider it to be exorbitant.

## DATA ANALYSIS

### *Inferential statistics*

Regression statistics	
Multiple R	0.206487
R square	0.042637
Adjusted R square	0.03687
Standard error	0.356009
Observation	169



The correlation coefficient (R) value of 0.2065 implies a weak relationship between housing affordability and income of the respondents in Olorunda local government area. The R<sup>2</sup> value of 0.0426 also indicates that less than 5% (4.2637) of the variation in housing affordability can be attributed to the variation in income while about 95% of the remaining variations is accounted for by other factors.

**Hypothesis 1**

H0: There is no significant relationship between income and housing affordability in Olorunda local government

H1: There is significant relationship between income and housing affordability in Olorunda local government

Level of significance: 5%

**ANOVA**

	df	SS	MS	F	Significance F
Regression	1	0.937	0.937	7.392964	0.007244
Residual	166	21.03919	0.126742		
Total	167	21.97619			

Decision: From the ANOVA table above, since the value of significant F = 0.007244 is less than the level of significance = 0.05, we reject the null hypothesis H0.

Conclusion: there is significant relationship between income and housing affordability in Olorunda Local Government.

**SUMMARY OF FINDINGS**

The findings from the analysis of questionnaire obtained from respondents coupled with personal interview, observation and reconnaissance survey of housing affordability in Olorunda Local Government revealed the following.

Findings shows that the rate at which rent on houses or the cost of building houses did not correspond to the rate at which their salary/income increases or their social economic status increases, these are revealed in table 5.1 average income per month, only 37(10.8%) earns above N30,000, the cost of construction is above N4m, 39(11.4%) as shown in table 5.2 while 73(21.3%) of the respondents paid above N5000-N10,000 as rent every month as shown in table 5.3 Majority of people find themselves living in houses that do not reflect their socio-economic status.

**CONCLUSION**

Natural growth increase within the urban area demand additional dwelling units for the growing population since the supply of housing units has not meet up with the housing demand. There is need for the government to making the housing production a continuous priority especially for the low and very low-income earners. Housing is a human right therefore there is need to make it affordable to majority of Nigerians.

## RECOMMENDATIONS

In order to increase the level of affordable housing units in Olorunda Local Government area of Osun State and Nigeria in general, the following suggestions are hereby made:

1. The income level of the people determines where they live, there is need for the government both at the local, state and federal to cater for general welfare of their staff through increment in salary, prompt payment of salary arrears and provision of building loans to boost the staff capacity to build community-based and non-governmental organization should be encouraged in facilitating the production of self-built housing.
2. There should be review and effective implementation of existing national housing policy in such a way that it will recognize the need to encourage a multiplicity of other actors (corporate private sectors, civil society organizations and individuals in housing delivery and improvement process.
3. There should be favourable investment climate for the private sector through reforming the housing finance structure, tax incentives and financial grants redefinition of institutional roles.
4. Site and services scheme should be encouraged the more. Since housing is not just a shelter built includes basic infrastructures and facilities around and within the house.
5. Provision of affordable building materials should be put in place by the government. This will ensure that construction materials are affordable to an average Nigerian.

## REFERENCES

- Adegun, O., Joseph, A., & Adebunsi, A. (2019). 1ST International Conference on Sustainable International Development
- Adeleke, F., & Olaleye, A. (2016). Determinants of Housing Affordability. Literature Review. AIRE FRES 2016-303. African Real Estate Society.
- Ankeli, I., Dabara, I., Oyeleke, O., Josua & Eytayo, J. (2015). Housing Condition and Residential property values, in Ede Nigeria. Conference of International Journal of Art and Sciences
- Aribigbola, A., & Okewole, I. A. (2011): Innovations and sustainability in housing policy conception and implementation, in Nigeria in I.A Okewole, A.Ajayi, A Daramola, K Odusanmi, O Ogunba (Eds): The built environment: Innovation of policy and sustainable development Ota Ogun state, Nigeria covenant university pp414-420,
- Anthonia, O., Adeniran, Hishamuddin, Mohd, A. (2019). Unleashing the Potentials Housing Affordability among the Nigeria Low-middle Income groups. International Journal of Scientific and Technology Research. Vol 8 July 2019.
- Babatunde, F. (2017). Determining Factors for Housing Affordability in Ibadan. Ethiopian Journal of Environment Studies and Management. 10 (5)642-633
- Balchin & Stewart (2001). Social Housing in Latin America. Opportunities for affordability in a region of housing need. Journal of Housing and Built Environment. 16,333-341.

- Gbilena, L., Roman, L. (2019). Housing Fund year 2019. Bucharest (RO): National Institute of Statistics (updated) 2020 May 2025. <http://inssc.ro/no/tags> .
- Housing and Urban Development (2005). Affordability Housing. CPD-HUD. <https://portal.hud.gov//affordablehousing>.
- Jingchun, L. (2011): "The development of Affordable housing. A case study in Guangzhou city, china" MSC thesis submitted to the department of real estate and construction management. Division of building and real estate economics, china.
- Jing, L. (2014). Recent Trends in Housing Affordability. Research studies. What are we up to? Urban Research Group. Working Paper series. No 5/2014.
- Luminta, M., Daniella, L., Vasiliu, H. (2020) Housing Affordability in the context of Co-Pandemic- New challenges for Romania. Lumen proceedings. Series ISSN.2601-2521.
- Meen, (2011). A long run Model of Housing Affordability. Housing Studies 26(718)1081-1103
- McClure, K. (2019): The allocation of rental assistance resources. The paradox of high housing costs and high vacancy rates, international journal of policy analysis 19,69-94. doi 10.1080/11949124.2017.1362756. (Taylor and Francis online).
- Pauletich & Cox, W. (2017). Housing affordability survey 2017 Belleville: 13th annual Demographic International.
- Sadou, A. (2019). 2018 Housing finance yearbook: Nigeria country profile Centre for affordable Housing Finance Africa. John Nnabugwu.



# IMPACT OF RISK FACTORS ON CONSTRUCTION PROJECTS' QUALITY IN NIGERIA

Ziyadul Hassan Ishaq<sup>1</sup>, Mu'awiya Abubakar<sup>2</sup>, Shehu Muhammad<sup>3</sup>, Yarima Sallau Lawal<sup>4</sup> and Ibrahim Isah<sup>5</sup>

<sup>1,2,3,4,5</sup>*Department of Building, Ahmadu Bello University, Zaria, Nigeria.*

One of the primary objectives of every construction project is meeting or exceeding the quality requirements of clients. The nature and complexity of construction projects encompass a lot of risks, which could hinder the attainment of the desired project quality. Evaluating the impact of risk is essential for determining the extent to which it could derail the attainment of project objectives. This study assessed the impact of risk factors on construction projects' quality in Nigeria. Quantitative research method comprising questionnaire survey was used for the study. Data was obtained using close ended structured questionnaires distributed to 192 construction practitioners. The impact of 65 risk factors on construction project quality was evaluated. Descriptive statistics was used to analyse the data. The study found eighteen (18) risk factors as having high impact on projects quality; the topmost being 'shortage of skilled labour' (MS = 4.30), 'poor design' (4.19), 'inadequate experience by project team' (4.18), 'deviating from specifications due to misunderstanding of drawings and specifications' (4.05) and 'inadequate project monitoring' (3.96). The study concludes that the impact of some risk factors could adversely lead to unacceptable quality reduction. The study recommends paying more attention to managing the risk factors having high impact so as to achieve the desired projects quality.

Keywords: assessment, construction projects, impact, quality, risk factors

## INTRODUCTION

The Construction sector is crucial to social and economic development of nations because of several reasons. Adeagbo (2014) posited that the sector possesses huge potential with respect to employment generation. The various activities undertaken in the sector are very useful to developing effective linkages among various sectors of the economy as well as sustaining economic development. Efforts at ensuring sound and sustainable national and economic development cannot ignore the importance of infrastructural development (transportation-road, rail, air, sea modes), industrial development (construction of industrial parks and factories),

<sup>1</sup> ziyadishaq2@gmail.com

<sup>2</sup> muawiyaabubakar@gmail.com

<sup>3</sup> shehudal@yahoo.com

<sup>4</sup> yerimasallau@gmail.com

<sup>5</sup> isahmk125@gmail.com

construction of institutional buildings, and provision of accommodation with respect to construction of various types of buildings, among others. These are areas where the construction sector is indispensable.

The Nigerian construction sector makes modest contribution to the national economy. According to National Bureau of Statistics '(NBS, 2011; 2012 and 2014) the sector accounted for 1.84 % of the country's Gross Domestic Product (GDP) in 2008. Furthermore, in year 2016 and 2017, the sector's contribution improved to 3.55% and 3.77% respectively (NBS, 2018). Moreover, 2020, the sector accounted for 3.50% of real GDP (NBS, 2021). The sector's average contribution over these years stood at 3.17%. Despite its contribution to the GDP, the sector and its stakeholders are afflicted with so much risks because of the nature of construction environment, organizations, business activities and processes (Ibironke, Famakin & Akingunola, 2011). According to Chieng, Wu and Huang (2014), the size and complexity of construction projects (CPs) are increasing, thus increasing risks.

ISO 31000 (ISO, 2009) simply defines risk as any event that has the potential of hindering the achievement of objectives. Odeyinka (2006) described risk in construction as a variable in the construction process whose variation results in uncertainty as to the final cost, duration, and quality of the project. In the construction industry, risk is a combination of activities that affect the project objectives (POs) of time, cost, quality and scope (Ehsan, et al, 2010). Therefore to successfully deliver a construction project, it is necessary to have risk management (RM) as an integral part of construction project management practice (Zou, Chen, & Chan 2010).

In the construction projects context, RM is a systematic way of identifying, analysing, and dealing with risks associated with a project with the aim of achieving the project objectives. Risks cannot be ignored in construction projects because the success or failure of a construction project may solely be dependent on the RM competences of the key stakeholders of such projects. Construction stakeholders are constrained by this reality and therefore continuously seek measures that will guarantee economic balance between risks and attainment of the primary project objectives (time, cost and quality).

Quality is described as the totality of features required by a product or service to satisfy a given need; fitness for purpose (Parfitt & Sanvido 1993). In a simpler term, quality means meeting or exceeding the clients 'requirement. Requirements will be predefined by client in contract agreement and the requirements consist of the established characteristics of products, processes, and services. All the parties involved in the project must fully understand those requirements and expectation in order to achieve a complete project that meets clients 'quality expectation (Ganaway, 2006). Quality performance can be determined by taking clients 'satisfaction into consideration.

Risk in construction, if not properly managed, could have a negative impact on the projects 'quality and could in turn causes client's dissatisfaction. Satisfaction has been explained as a function to make comparison between a perception of an outcome by an individual and the expectation of the outcome. Client's satisfaction has become challenging issue for the past few decades in construction industry. Usually, clients of construction sector experienced dissatisfaction in many aspects

including poor quality (Tiong et al., 2014) and could partly be attributed to improper identification and management of the risks.

Risk has also been broadly categorized as either subjective or objective and so, risk can either be subjectively or objectively analysed. Subjective risks are the ones which are analysed based on the experience and knowledge of the analyst, whereas objective risks are analysed by calculation of their actual impact and likelihood recorded in project risk registers. Adams (2008) believes that most of the construction project's risks are subjective because there are not sufficient historical data for their quantitative analysis and should be analysed according to analyst's judgment. This study therefore adopted the subjective risk assessment method.

Researchers (Laryea et al., 2012; Enshassi & Mosa, 2008; Aliyu, 2013; Baba, 2014; Hedaya & Saad, 2017) have identified the risk factors that affect construction projects success. These include changes in scope of work on site, incomplete design at the time of tender, contractual claims, financial difficulty of owner, delay in progress payments by clients, poor of cost planning and monitoring of funds, variations and additional works among others. Many research efforts (Ishaq et al 2020; Ishaq et al 2021a; Ishaq et al 2021b; Abd El-Karim et al 2015; Yusuf 2016; Ghulam & Noel 2017,) have been made to study the influence of risk on time and cost objectives of construction projects. However, there is dearth of literature on the influence of risk on construction project's quality especially at the design and construction phases. Much has not been documented in this regard and therefore construction stakeholders have less information on the risk factors that could have high impact on projects 'quality. More so, quality is considered as one of the three primary objectives of construction projects that cannot be ignored. Therefore, this study sought to fill this knowledge gap.

## **LITERATURE REVIEW**

### **Risk and construction projects**

Risk is an uncertain event or set of circumstances that its occurrence will have an effect on achievement of one or more project objectives (PMI, 2004). Risk in relation to construction is an event in the process of a construction project in which its occurrence will lead to uncertainty in the final cost, duration or quality of the project (Akintoye & Macleod, 1997). According to Smith et al (2006), construction project irrespective of its size is subject to more risks because of distinctive characteristics of construction such as financial intensity, complex procedures, lengthy duration, aggressive environment and dynamic arrangements of organizations. Many other factors affect the level of risk including situation of market, level of competition, size of the project, political and economic variations, expertise of parties (PMI, 2004).

Because of the complexity and uniqueness of construction projects, the risk present in each construction project vary (Panthi et al., 2009). Construction projects consist of various stages or phases as described by different authors with all leading to the similar project life cycles. Liu and Zhu (2007) divide construction stages into conceptual, design, tender, preconstruction, and construction. Zou et al (2006) also divided the stages of a construction project into feasibility, design, construction, and operation. PMI (2004) defined phases of construction project as Concept,

Planning, Detailed Design, Construction, and post Construction. The number of phases may also increase depending on the managers 'viewpoint.

Risks in construction projects are distributed through the entire project life cycle. It is very likely that some of the risks may occur at more than one phase of the project life cycle. There are arguments regarding the degree of risk in different phases of a construction project. Godfrey (1996) believe that the greatest degree of risk exist in the earliest phase of the project when available information about the project is the least. This is in agreement with other researchers such as Hassanein and Afify (2007) who have stated that risk is at its peak in the conceptual phase. However, Zou et al. (2006) consider the construction phase to be more risky phase than the feasibility (conceptual) phase. In addition, there are other theorists believing that risks of construction projects increase as the project progresses which means that each phase of the construction project includes more risks than the previous ones. However, Wang et al (2004) considers that risk in construction projects greatly depends on the type of the project as well as the contract type. Oyewobi et al. (2012) further asserted that, the common consequences of project risks amongst others are cost overruns, time overruns, poor quality, and disputes among the parties to a construction contracts. Oyewobi et al., (2012) also added that risk is an important issue to contractors as well as clients and consultants of the industry and that, the problems of risk assessment are complex and poorly understood in practice.

Various institutes and authors have classified construction risks into different types and hierarchies. Smith and Bohn (1999) have classified construction risk as either internal or external. Risk has also been broadly categorized as either subjective or objective. Risks can be further subcategorized into smaller groups according to their type and impact. Wiguna and Scott (2006) classified risks into four categories: economic and financial risks, external and site condition risks, technical and contractual risks, and managerial risks. PMI (2004) also categorise risk into another four categories: Technical risks, organizational risks, project risks and external risks (TOPE risks). Hedaya and Saad (2017) classified risk into 8 groups to include contractor's site management related factors, design and documentation related factors, financial management related factors, information and communication related factors, human resource related factors, non-human resource related factors, project management and contract administration related factors, and environmental related factors. Enshassi and Mosa (2008) also classified risk as physical, environmental, design, logistics, financial, legal and construction. The risk factors from various studies were harmonized and adopted to develop the questionnaire for the study.

## **METHODOLOGY**

The study adopted quantitative research approach because of the nature of the problem that seek to address 'how much of an impact 'using questionnaire survey. A structured closed ended questionnaire containing 65 project risk factors (grouped into 10) was designed to enable data collection. Questionnaire is the most widely used and useful instrument for collecting survey information because it provide structured, often numerical data and it can be administered with or without the presence of the researcher (Wilson & McLean 1994; Cohen, Manion &

Morrison 2007). The questionnaire was validated by experts in academia and industry prior to commencement of data collection. Respondents were asked to rate the impact of the risk factors on project quality (PQ) on a 5-point scale (1= Negligible to 5= Very high). A risk impact assessment guide by PMI (2004) as shown in Table 1 was adopted to guide the respondents and discussion of the results.

The study population consists of construction practitioners (Architects, Builders, Engineers, Quantity Surveyors and Project Managers). The justification for the selection of practitioners is that, practitioners have the knowledge and skills with regard to technical and managerial aspect of construction works. Hence, they are aware or more informed about the various risks associated with construction projects as well as the effects the risks may have on the quality of construction projects. A minimum sample size of 96 was determined using by Cochran (1977) formula, at 95% confidence level, 10% confidence interval and 50% degree of variability. In accordance with Glenn (1992) the sample size was increased to account for non-responses and incomplete responses. Considering the large number of variables contained in the data collection instrument, a valid response rate of at least 50% was assumed. Therefore 100% of the estimated sample size was added making a total of 192 distributed questionnaires. Convenience sampling technique was used to administer the questionnaires to target respondents. A total of 138 questionnaires were duly completed and returned while only 114 were useful for analysis, representing 59.38% valid responses.

Descriptive statistics was used to analyse the data. This has also been used in similar studies by Ishaq et al (2021a); Ishaq et al (2021b); Salawu (2016); Abdulrahman (2018). Mean scores and standard deviation were computed and used to rank the impact of the risk factors on PQ. A risk factor having mean score  $\leq 1.49$  is considered to have negligible (very low) impact; risk factor with mean score 1.5 to 2.49 is considered to have low impact; risk factor with mean score 2.5 to 3.49 is considered to have moderate impact; risk factor with mean score 3.5 to 4.49 is considered to have high impact; and risk factor with mean score  $\geq 4.5$  is considered as having very high impact. The standard deviation was used to rank the factors where there is a tie in the mean scores.

**Table 1: Risk impact assessment guide**

Identified risk factor	Project objectives	Negligible 1	Low 2	Moderate 3	High 4	Very high 5
Risk factor	QUALITY	Quality degradation barely noticeable	Only very demanding applications are affected	Quality reduction requires sponsor approval	Quality reduction unacceptable to sponsor	Project end item is effectively useless

Source: PMI (2004)

## RESULTS AND DISCUSSION

### Assessment of impact of the risk factors on Project Quality (PQ)

Respondents were presented with 65 risk factors affecting construction projects and were asked to rate the impact of the risk factors on quality of construction



projects on a 5 point scale (1= negligible and 5= very high). The risk factors are categorised into 10 groups and the result is presented in Table 2.

**Table 2: Impact of the risk factors on project quality (group wise)**

S/N	Risk Factors	Mean	SD	Group Rank
A	Contract Administration and Project Management Related Factors			
1	Bribery and Corruption	3.91	.916	1
2	Poor project management	3.69	1.131	2
3	Inaccurate quantity take-off	3.12	.599	3
4	Undefined scope of work	3.10	.852	4
5	Change in the scope of the work	3.02	.794	5
6	High Competition in Bids	2.94	1.885	6
7	Delay in decision making	2.17	1.180	7
	Group Mean	3.14		
B	Design Related Factors	Mean	SD	Group Rank
1	Poor design	4.19	.833	1
2	Mistakes/ errors in design	3.77	.866	2
3	Frequent design changes	3.63	.827	3
4	Incomplete design at the time of tender	3.09	.978	4
5	Delay in approval of design	2.59	1.331	5
6	Delay in design	2.38	.849	6
	Group Mean	3.28		
C	Construction and Contractor's Site management Related Factors.	Mean	SD	Group Rank
1	Inadequate experience by project team	4.18	.928	1
2	Deviating from specifications due to misunderstanding of drawings and specifications	4.05	.727	2
3	Inadequate project monitoring	3.96	.775	3
4	Poor site supervision	3.89	.615	4
5	Mistakes during construction	3.82	.793	5
6	Inadequate cost estimate	3.74	.821	6
7	Poor site management	3.74	.753	7
8	Inadequate project control	3.73	.856	8
9	Incompetent subcontractors	3.56	1.013	9
10	Inadequate time estimate	3.22	1.029	10
11	Schedule delay	3.14	.889	11
12	Equipment failure	2.93	.761	12
13	Equipment unavailability	2.81	.694	13
14	Undocumented change orders	2.69	.597	14
15	Materials theft	2.64	1.001	15
16	Shortage of materials	2.61	.771	16
17	Late delivery of materials	2.58	1.261	17
18	Materials wastage	2.54	.804	18
19	Late delivery of equipment	2.50	1.262	19
20	Labour accident	2.27	1.016	20
	Group Mean	3.23		
D	Financial Related Factors	Mean	SD	Group Rank
1	Poor cash flow management	3.39	.699	1
2	Financial difficulties of owner	3.39	.771	2
3	Financial failure of contractor	3.38	1.020	3
4	Delay in progress payment by owner/client	3.32	.896	4
5	Poor financial control on site	3.13	.759	5
6	Delay in payment to supplier/subcontractor	2.66	.865	6
7	Contractual claims	2.42	1.318	7
	Group Mean	3.10		
E	Information and Communication Related Factors	Mean	SD	Group Rank
1	Lack of coordination between stakeholders	3.03	.864	1
2	Poor communication between stakeholders	2.91	.868	2
3	Slow information flow between stakeholders	2.84	.974	3
	Group Mean	2.93		

**Table 2 cont'd: Impact of the risk factors on project quality (group wise)**

F	Legal Related Factors	Mean	SD	Group Rank
1	Legal disputes during construction phase among contract parties	2.81	.830	1
2	Lack of specialised arbitrators to help settle dispute fast	2.27	1.182	2
3	Difficulty of obtaining permits from regulatory authorities	2.26	1.311	3
4	Ambiguity of work legislations	2.10	1.381	4
	Group Mean	2.36		
G	Human Resource (Workforce) Related Factors	Mean	SD	Group Rank
1	Shortage of skilled labour	4.30	.499	1
2	Shortage of technical personnel	3.80	.658	2
3	Difficulty in training new labour	3.70	.889	3
4	Shortage of unskilled labour	3.43	.975	4
5	Poor labour productivity	3.12	.898	5
6	Labour absenteeism	2.95	.850	6
7	High cost of labour	2.74	1.064	7
	Group Mean	3.43		
H	Economic Related Factors	Mean	SD	Group Rank
1	Increase in interest rates	2.89	.866	1
2	Increase in exchange rates	2.78	.870	2
3	Increase in prices of materials	2.77	.729	3
4	Increase in cost of labour	2.56	.799	4
5	Increase in fuel/oil Prices	2.12	.922	5
	Group Mean	2.63		
J	Political Related Factors	Mean	SD	Group Rank
1	Political crises/Civil unrest	3.23	1.004	1
2	Changes in governmental Laws	2.40	1.086	2
3	Unfavourable Governmental policies	2.36	1.012	3
	Group Mean	2.66		
K	Environmental Related Factors	Mean	SD	Group Rank
1	Force majeure (earthquake, flood etc.)	3.86	1.231	1
2	Unfavourable project location	3.11	.910	2
3	Effects of weather	2.98	1.052	3
	Group Mean	3.32		

Table 2 presents the impact of the risk factors on projects quality (PQ). As seen in the Table, a total of 65 risk factors were presented and grouped into 10. The first group of factors (Group A) is the Contract administration and project management related factors containing 7 sub factors. Risk incurred due to bribery and corruption has the highest mean value (3.91) and is therefore considered as the risk factor with the highest impact on PQ within this group thus ranked 1st. while Poor project management (3.69) and inaccurate quantity take-off (3.12) are the 2nd and 3rd risk factors with highest mean value. On the other hand, the risk factor having the lowest mean value under this category is Delay in decision making (2.17) thus ranked 7th. Also as it can be seen in the same group (A), first two risk factors (those ranked 1st and 2nd) have a mean value within the range of (3.51 to 4.49) thus

considered as having high impact on PQ while all the remaining risk factors under this group with the exception of the risk factor ranked 7th have mean value ranging from (2.51 to 3.49) and are considered as having moderate impact on project completion cost. However, the risk factor ranked 7th (delay in decision making) have a mean score of (2.17) thus considered as having low impact on PQ. Furthermore, this group has an overall mean value of (3.14)

The second group of factors (Group B) is the design related risk factors. Under this category, it can be seen that, the risk factor with highest impact on PQ is poor design having a mean score of (4.19) and is therefore ranked 1st followed by mistakes and error in design (3.77) ranked 2nd and Frequent design changes (3.63) ranked 3rd. on the other and, the risk factor with the least impact on PQ is delay in design having a mean value of (2.38) and therefore ranked 6th. Risk factors ranked 1st to 3rd under this group have a mean value ranging from (3.50 to 4.49) and are therefore categorised as having high impact on project completion cost while the risk factors ranked 4th and 5th have a mean value ranging from (2.50 to 3.49) hence considered as having moderate impact on PQ. The risk factor ranked 6th have a mean value of (2.38) and is therefore considered as having low impact on PQ. This group also has an overall mean value of (3.28)

Construction and contractors site management related factors (Group C) contain 20 sub factors. Under this group, the first three risk factors with the highest mean score are inadequate experience by project team (4.18), deviating from specifications due to misunderstanding of drawings and specifications (4.05) and inadequate project monitoring (3.96). These risk factors are ranked 1st, 2nd and 3rd respectively. On the other hand, materials wastage (2.50), late delivery of equipment (2.47) and late delivery of materials (2.39) are the risk factors with the lowest mean value in this group in this group thus ranked 18th 19th and 20th. Furthermore, out of the twenty risk factors under this category, nine of them (factors ranked 1st to 9th) have a mean score ranging from (3.5 to 4.49) and are therefore considered as having high impact on PQ while all the remaining risk factors under this group with the exception of the risk factor ranked 20th have mean score ranging from (2.5 to 3.49) and are therefore considered as having moderate impact on PQ. The risk factor ranked 20th (labour accident) have a mean value of (2.27) and is therefore considered as having low impact on PQ. Furthermore, this group has an overall group mean of (3.23).

Financial related factors (Group D) has 7 sub factors. Under this category, the first three risk factors with the highest mean score are Poor cash flow management with mean score of (3.39), financial difficulties of owner (3.39) and financial failure of contractor (3.38). These factors based on their mean scores are ranked 1st, 2nd and 3rd respectively. On the other hand, the risk factors with lowest mean scores are delay in payment to supplier/subcontractor (2.66) and contractual claims (2.42) thus ranked 6th and 7th respectively. Furthermore, it can also be seen from the Table that risk factors ranked 1st to 6th under this category have mean score ranging from (2.5 to 3.49) and therefore can be considered as having moderate impact on PQ while the risk factors ranked 7th have a mean score of (2.42) thus, considered as having moderate impact on PQ. This group also have an overall group mean of (3.10).

Information and communication related factors (Group E) has 3 sub factors. All the risk factors have a mean score ranging from (2.5 to 3.49) and are considered as having moderate impact on PQ. The risk factor with highest mean score under this category is lack of coordination between stakeholders (3.03) followed by poor communication between stakeholders (2.91) and slow information flow between stakeholders (2.85). These risk factors are ranked 1st, 2nd and 3rd respectively. The group also has an overall mean score of (2.93).

Legal related factors (Group F) have 4 sub factors. The risk factor with highest impact on project completion cost is Legal disputes during construction phase among contract parties (2.81) followed by lack of specialised arbitrators to help settle dispute fast (2.27). These risk factors are ranked 1st and 2nd respectively. On the other hand, Ambiguity of work legislations have the least mean score (2.10) thus ranked 4th. Furthermore, the risk factor ranked 1st under this category has a mean score of (2.81) thus considered as having moderate impact on PQ while the remaining risk factors (those ranked 2nd, 3rd and 4th ) have a mean score ranging from (1.5 to 2.49) thus considered as having low impact on PQ. The group also has an overall mean score of (2.36)

Human resources (workforce) related factors (Group G) has 7 sub factors. Under this group, the first three risk factors with the highest mean values are shortage of skilled labour with mean score of (4.30), Shortage of technical personnel (3.80) and difficulty in training new labour (3.70) and are therefore ranked 1st, 2nd and 3rd respectively. On the other hand, the risk factors with lowest mean values are poor labour productivity (3.12), labour absenteeism (2.95), and high cost of labour (2.74) and are ranked 5th, 6th and 7th respectively. Furthermore, the Table also shows that under this category, the risk factors ranked (1st to 3rd) have mean score ranging from (3.5 to 4.49) therefore can be considered as having high impact on PQ while risk factors ranked (4th to 7th) have a mean score ranging from (2.5 to 3.49) and are considered as having moderate impact on PCC. The group has an overall mean score of (3.43)

Economic related factors (Group H) has 5 sub factors. The risk factor with highest mean score under this category is increase in interest rates with a mean score of (2.89) followed by increase in exchange rates (2.78). On the other hand, the risk factor with the lowest mean score is increase in fuel/oil prices with a mean score of (2.12). Furthermore all the risk factors under this category, with the exception of the factor ranked 5th obtained a mean score ranging from (2.5 to 3.49) and are thus considered as having high impact on PQ. The risk factor ranked 5th has a mean score of (2.12) thus has moderate impact on PQ. The group has an overall mean value of (3.63)

Political related factors (Group J) has 3 sub factors. The risk factor with highest mean score under this category is political crises/civil unrest (3.23) followed by changes in governmental Laws (2.40) and unfavourable Governmental policies (2.36). These risk factors are ranked 1st, 2nd and 3rd respectively. The risk factor ranked 1st has a mean score ranging from (2.5 to 3.49) thus considered as having moderate impact on PQ while the remaining two risk factors under this category have a mean value ranging from (1.5 to 2.49) and are therefore considered as having low impact on PQ. The group has an overall mean score of (2.63).

The last group of the risk factors Group (K) is the environmental related factors having 3 sub factors. The risk factor with the highest mean score under this category is force majeure (earthquake, flood etc.) (3.86) and therefore ranked 1st followed by unfavourable project location (3.11) ranked second and effects of weather (2.98) ranked 3rd. The risk factor ranked 1st has a mean value of (3.86) thus considered as having high impact on PQ while the risk factors ranked 2nd and 3rd have mean values ranging from (2.50 to 3.49) thus considered as having moderate impact on PQ. This group has an overall mean score of (3.32).

Comparing the group mean scores of the risk factors, human resources (workforce) related factors has the highest group mean (3.43) therefore ranked 1st followed by design related factors (3.28) and environmental related factors (3.32) thus ranked 2nd and 3rd respectively. On the other hand, the groups with the lowest mean score are economic related factors having a mean score of (2.77) and legal related factors (2.36) thus ranked 9th and 10th respectively. The results are presented in Table 3

**Table 3: Comparison of Mean scores for the impact of the risk factors on project quality across the Categories of Factors**

Codes	Risk factors group	Group Mean	Group Rank
G	Human resources (workforce) related factors	3.43	1
K	Environmental related factors	3.32	2
B	Design related factors	3.28	3
C	Construction and contractors' site management related factors	3.23	4
A	Contract administration and project management related factors	3.14	5
D	Financial related factors	3.10	6
E	Information and communication related factors	2.93	7
J	Political related factors	2.66	8
H	Economic related factors	2.63	9
F	Legal related factors	2.36	10

As seen in Table 3, all the groups of factors with the exception of legal related factors (group F) have a group mean scores ranging from (2.5 to 3.49) thus considered as having moderate impact on PQ while the exception have a mean value ranging from (1.5 to 2.49) thus considered as having low impact on PQ. Human resources (workforce) related factors (3.43) was identified as the group with highest impact on PQ though the overall impact was moderate, followed by environmental related factors (3.32) and design related factors (3.28).

Furthermore, Table 4 presents the overall impact of the risk factors on PQ in descending order of their mean values.

**Table 4: Overall impact of the risk factors on construction project quality.**

S/N	Risk Factors	Mean	SD	Rank
1	Shortage of skilled labour	4.30	.499	1
2	Poor design	4.19	.833	2
3	Inadequate experience by project team	4.18	.928	3
4	Deviating from specifications due to misunderstanding of drawings and specifications	4.05	.727	4
5	Inadequate project monitoring	3.96	.775	5
6	Bribery and Corruption	3.91	.916	6
7	Poor site supervision	3.89	.615	7
8	Force majeure (earthquake, flood etc.)	3.86	1.231	8
9	Mistakes during construction	3.82	.793	9
10	Shortage of technical personnel	3.80	.658	10
11	Mistakes/ errors in design	3.77	.866	11
12	Poor site management	3.74	.753	12
13	Inadequate cost estimate	3.74	.821	13
14	Inadequate project control	3.73	.856	14
15	Difficulty in training new labour	3.70	.889	15
16	Poor project management	3.69	1.131	16
17	Frequent design changes	3.63	.827	17
18	Incompetent subcontractors	3.56	1.013	18
19	Shortage of unskilled labour	3.43	.975	19
20	Poor cash flow management	3.39	.699	20
21	Financial difficulties of owner	3.39	.771	21
22	Financial failure of contractor	3.38	1.020	22
23	Delay in progress payment by owner/client	3.32	.896	23
24	Political crises/Civil unrest	3.23	1.004	24
25	Inadequate time estimate	3.22	1.029	25
26	Schedule delay	3.14	.889	26
27	Poor financial control on site	3.13	.759	27
28	Inaccurate quantity take-off	3.12	.599	28
29	Poor labour productivity	3.12	.898	29
30	Unfavourable project location	3.11	.910	30
31	Undefined scope of work	3.10	.852	31
32	Incomplete design at the time of tender	3.09	.978	32
33	Lack of coordination between stakeholders	3.03	.864	33
34	Change in the scope of the work	3.02	.794	34
35	Effects of weather	2.98	1.052	35
36	Labour absenteeism	2.95	.850	36
37	High Competition in Bids	2.94	1.885	37
38	Equipment failure	2.93	.761	38
39	Poor communication between stakeholders	2.91	.868	39
40	Increase in interest rates	2.89	.866	40
41	Slow information flow between stakeholders	2.84	.974	41
42	Equipment unavailability	2.81	.694	42
43	Legal disputes during construction phase among contract parties	2.81	.830	43
44	Increase in exchange rates	2.78	.870	44
45	Increase in prices of materials	2.77	.729	45
46	High cost of labour	2.74	1.064	46
47	Undocumented change orders	2.69	.597	47

**Table 4 cont'd: Overall impact of the risk factors on construction project quality.**

48	Delay in payment to supplier/subcontractor	2.66	.865	48
49	Materials theft	2.64	1.001	49
50	Shortage of materials	2.61	.771	50
51	Delay in approval of design	2.59	1.331	51
52	Late delivery of materials	2.58	1.261	52
53	Increase in cost of labour	2.56	.799	53
54	Materials wastage	2.54	.804	54
55	Late delivery of equipment	2.50	1.262	55
56	Contractual claims	2.42	1.318	56
57	Changes in governmental Laws	2.40	1.086	57
58	Delay in design	2.38	.849	58
59	Unfavourable Governmental policies	2.36	1.012	59
60	Labour accident	2.27	1.016	60
61	Lack of specialised arbitrators to help settle dispute fast	2.27	1.182	61
62	Difficulty of obtaining permits from regulatory authorities	2.26	1.311	62
63	Delay in decision making	2.17	1.180	63
64	Increase in fuel/oil Prices	2.12	.922	64
65	Ambiguity of work legislations	2.10	1.381	65

Table 4 presents the impact of all the 65 risk factors on PCC irrespective of their groupings. As seen in the Table, the first five risk factors with the highest mean scores are shortage of skilled labour (4.30), poor design (4.19), inadequate experience by project team (4.18), deviating from specifications due to misunderstanding of drawings and specifications (4.05) and inadequate project monitoring (3.96). These risk factors are ranked 1st, 2nd, 3rd, 4th, and 5th, respectively. On the other hand the last five risk factors having the lowest mean score are lack of specialised arbitrators to help settle dispute fast having a mean value of (2.27), difficulty of obtaining permits from regulatory authorities (2.26), delay in decision making (2.17), increase in fuel/oil Prices (2.39) and ambiguity of work legislations (2.10) and are therefore ranked 61st, 62nd, 63rd, 64th and 65th respectively.

Furthermore, out of the 65 risk factors considered in the study, eighteen risk factor (those ranked 1st to 18th ) have a mean value ranging from (3.5 to 4.49) and are therefore considered to have high impact on PQ. This implies that, these risk factors could lead to project quality reduction that will not be acceptable by the client. Therefore, the risk factors identified to have high impact on PQ should be given more attention and appropriately managing them to minimise their adverse effects on the quality of the construction works.

Similarly, thirty seven risk factors (those ranked 19th to 55th) have a mean score ranging from (2.5 to 3.49) hence, can be considered as having moderate impact on PQ. Meanwhile the remaining ten risk factors (those ranked 56th to 65th) have a mean score ranging from (1.5 to 2.49) hence considered as having low impact on PQ.

## CONCLUSIONS

The paper assessed the impact of project risk factors on construction projects' quality. The study concludes that, shortage of skilled labour, poor design, inadequate experience by project team, deviating from specifications due to misunderstanding of drawings and specifications and inadequate project monitoring to be the six (6) topmost risk factors that negatively impacts the quality of construction projects. Moreover, it was also concluded that, of the sixty five (65) risk factors assessed, eighteen (18) risk factors have a high impact on PQ while thirty seven (37) risk factors are having a moderate impact on PQ, ten (10) of the risk factors have a low impact. In addition, it was also concluded that the impact of some risk factors (those with high impact) could adversely lead to unacceptable quality reduction. The study recommends paying more attention to managing the risk factors having high impact so as to achieve the desired projects' quality.

The limitation of this research is that, the paper did not consider the frequency of occurrence of the risk factors, however, in order to determine the significance/severity of the effects of the risk factors on project 'quality, there is the need to assess the frequency of occurrence of the risk factors and make further evaluation. This is because the severity of a risk factor is best determined as a product of the frequency of occurrence of the risk and its magnitude of impact. As such, further research is being carried out in this regard.

## REFERENCES

- Abd El-Karim, M. S. B. A., El Nawawy, O. A. M., & Abdel-Alim, A. M. (2015) "Identification and assessment of risk factors affecting construction projects", *HBRC Journal* (2015), <http://dx.doi.org/10.1016/j.hbrj.2015.05.001>
- Abdulrahman, R. S. (2018). Assessment of the Risk management Maturity of Construction Organisations in Joint Venture Projects in Nigeria. Unpublished M.Sc. Dissertation. Ahmadu Bello University, Zaria.
- Adams, F. K. (2008) „Construction contract risk management: a study of practices in the United Kingdom“, *Cost Engineering*, 50(1), pp. 22-33
- Adeagbo, A. (2014). Overview of the Building and construction sector in the Nigerian Economy ISSN 1596-8308. [www.transcampus.org/journals](http://www.transcampus.org/journals); [www.ajol.info/journals/jorind](http://www.ajol.info/journals/jorind)
- Akintoye, A. S., & Macleod, M. J. (1997) „Risk analysis and management in construction“. *International Journal of Project Management*. 12(1), pp.31-38
- Chieng, K.-F., Wu, Z.-H., & Huang, S.-C. (2014). Identifying and assessing critical risk factors for BIM projects: Emperical study. *Automation in Construction*, 45:1-15. DOI: 10.1016/j.autcon.2014.04.012
- Cohen, L., Manion L. & Morrison, K. (2007). *Research Method in Education*. Taylor & Francis: London
- Ehsan, D. N., Alam, M., Mirza, E., & Ishaque, A. (2010). Risk Management in Construction Industry. *Intitute of Electrical and Electronics Engineers*, 16-21.



- Enshassi, A., & Mosa, J. A. (2008). Risk Management in Building Projects: Owners' Perspective. *The Islamic University Journal (Series of Natural Studies and Engineering)*, Vol. 16, No.1, pp. 95- 123. ISSN 1726-6807, <http://www.iugaza.edu.ps/ara/research>
- Ganaway, N. B. (2006) *Construction Business Management: A Guide to Contracting for Business Success*, Butterworth-Heinemann, London, UK, 2006
- Ghulam, A. N., & Noel, P. (2017) Significant Factors Causing Cost Overruns in the Construction Industry of Afghanistan. *7th International Conference of Engineering and Production Management*, 182(2017) 510-517
- Glenn D. I., (1992). "Determining Sample size" IFAS, University of Florida. PEOD-6. October
- Godfrey, P. (1996) *Control of risk: a guide to the systematic management of risk from construction*, construction industry research and information association, London.
- Hassanein A. G., & Afify, H. M. (2007) „Contractor"s perceptions of construction risks – a case study of power station projects in Egypt", *Cost Engineering*, 49 (5), pp. 25-34.
- Hedaya, A. M. A. & Saad, M. A. S. (2017). "Cost Overrun Factors in construction projects in Bahrain" *Modern Applied Science*; 11 (7) <https://doi.org/10.5539/mas.v11n7p20>
- Ibironke, O. T., Famakin, I. O., & Akingunola, T. O. (2011). Evaluating Risk factors for Build, Operate & Transfer Procurement in the Nigeria Construction Industry. *Built Environment journal*, Vol. 8, No. 1, pp. 37- 44.
- Ishaq Z. H., Abubakar, M., Muhammad, S., & Lawal, Y. S. (2021b). [Forthcoming]. Impact of Risk Factors on Construction Projects 'Completion Cost in Nigeria. *LAUTECH Journal of Civil and Engineering Studies*, DOI:10.36108/laujoces/1202.60.0270
- Ishaq Z. H., Muhammad, S., Abubakar, M., & Lawal, Y. S. (2020). [Forthcoming]. Effects of Project Risk Factors on Construction Projects 'Completion Time in Nigeria *Environ*
- Ishaq Z. H., Muhammad, S., Abubakar, M., & Lawal, Y. S. (2021a). An Assessment of the Impact of Project Risk Factors on Project Completion Time in Nigeria. *A journal of Faculty of Environmental Studies (JED)*, University of Uyo, *JED* 16(1),93-101
- ISO. (2009). "Risk management—Principles and guidelines." ISO 31000, Lausanne, Switzerland, 10–11.
- Liu, L. & Zhu, K. (2007) „Improving cost estimates of construction projects using phased cost factors", *Journal of Construction, Engineering and Management*, 133(1), pp. 91-95.
- NBS (2011). 2010 and Q1, Q2 2011 GDP for Nigeria, NBS, Central Business District, Abuja [www.nigerianstat.ng](http://www.nigerianstat.ng), accessed on September 18, 2018.
- NBS (2012) Revised 2010 and Estimates for Q1- Q4, Gross Domestic Product for Nigeria, NBS, Abuja, [www.nigerianstat.ng](http://www.nigerianstat.ng), accessed on September 18, 2018.
- NBS (2014) 2012 and Estimates for Q1-Q3, 2013 Gross Domestic Product for Nigeria, NBS, Abuja, [www.nigerianstat.ng](http://www.nigerianstat.ng), accessed on September 19, 2018
- NBS (2018) 2017 Q4, and full year Gross Domestic Product for Nigeria, NBS, Abuja, [www.nigerianstat.ng](http://www.nigerianstat.ng), accessed on October 17, 2018
- NBS (2021) 2020 Nigerian Gross Domestic Product Report Q4 & Full year. [www.nigerianstat.ng](http://www.nigerianstat.ng), accessed on March 04, 2020.
- Odeyinka H. A., (2006). An Evaluation of the use of Insurance in Managing Construction Risks, *Construction Management and Economics* 18(5), 519-524

- Oyewobi, L. O., Ibrahim, A. D., & Ganiyu, B. O. (2012). Evaluating the Impact of Risk on Contractor's Tender figure in Public Buildings Projects in Northern Nigeria. *Journal of Engineering, Project, and Production Management*, 2(1), 2-13.
- Panthi, K., Ahmed, S., & Ogunlana, S. (2009) „Contingency estimating for construction projects through risk analysis“. *International journal of construction education and research*. 5, pp. 79-94.
- Parfitt M. K., & Sanvido V. E. (1993). Checklist of critical success factors for building projects," *Journal of Management in Engineering*, vol.9, no.3, pp.243–249
- Project Management Institute (PMI), (2004) *Project Management Body of Knowledge (PMBOK)*, 3rd ed. USA: Project Management Institute, Inc.
- Salawu, R. A. (2016). Time risk assessment framework for highway projects in Nigeria. Unpublished PhD thesis. Universiti Teknologi Malaysia.
- Smith, G., & Bohn, C. (1999) "Small to Medium Contractor Contingency and assumption of risk". *Construction Engineering and Management*. 125 (2), pp. 101-108.
- Smith, N. J., Merna, T., & Jobling, P. (2006). *Managing risk in construction projects*. Oxford: Blackwell Science Ltd.
- Tiong, K. L., Norhayati, Z., Muhamad Z. M. S., Mohd. S. M A., & Choy, S. T (2014). Using Project Performance to Measure Effectiveness of Quality Management System Maintenance and Practices in Construction Industry. *The Scientific World Journal* Volume 2014, Article ID 591361.<http://dx.doi.org/10.1155/2014/591361>
- Wang, S. Dulaimi, M., & Aguria, M. (2004) „Risk management framework for construction projects in developing countries“, *Construction Management and Economics*, 22, pp. 237-252.
- Wiguna, I. P. A., & Scott, S. (2006) „Relating risk to project performance in Indonesian building contracts, *Construction Management and Economics*, 24(11), pp. 1125-1135.
- Wilson, N., & McLean, S. (1994) *Questionnaire Design: A Practical Introduction*. Newtown Abbey, Co. Antrim: University of Ulster Press.
- Yusuf, O. A. (2016). Relationship between Time Overrun And Completion Cost of Construction Projects In Lagos State, Nigeria. Unpublished M.Sc. Dissertation submitted to Department of Quantity Surveying, Obafemi Awolowo University, Ile-Ife, Osun State, Nigeria
- Zou, P., Zhang, G., & Wang, J. Y. (2006) "Identifying key risks in construction projects: Life cycle and stakeholder perspectives", *Proc. 12th Pacific real estate society conference*. Auckland, New Zealand, 22-25 January.
- Zou, P., Zhang, G., & Wang, J. Y. (2006) "Identifying key risks in construction projects: Life cycle and stakeholder perspectives", *Proc. 12th Pacific real estate society conference*. Auckland, New Zealand, 22-25 January.



# INVESTIGATING THE EFFECT OF COVID-19 DRIVEN INFLATION ON COMMERCIAL PROPERTY HEDGING CAPACITY IN LAGOS, NIGERIA

Muktar Babatunde Wahab<sup>1</sup>, Wasiu Ayobami Durosinmi<sup>2</sup>, Matthew Mamman<sup>3</sup>,  
Yetunde Christianah Charles-Afolabi<sup>4</sup> and Dodo Usman Zakari<sup>5</sup>

<sup>1</sup>*Estate Management Department, Kaduna State University Kafanchan Campus, Nigeria*

<sup>2</sup>*Estate Management Department, University of Ilorin, Kwara State, Nigeria*

<sup>3</sup>*Estate Management Department, Federal Polytechnics Kaduna, Nigeria*

<sup>4</sup>*Estate Management Department, Redeemer's College of Technology and Management, Ogun State, Nigeria*

<sup>5</sup>*Estate Management & Valuation Department, Niger State Polytechnics, Zungeru, Nigeria*

The study investigated the current effect of covid-19 driven inflation on commercial property investment in Lagos with a view to establishing the hedging capacities of the commercial property market. The study thereby focused on examining complete, partial, perverse and zero hedging characteristics of inflation driven by covid-19 in the market. The study used monthly data (March, 2020 and March 2021) on covid-19 rates, inflation rates (actual, expected and unexpected) and returns on commercial properties. The study therefore investigated the co-movement between covid-19 rates and inflation rates in order to establish the causal linkage between covid-19 rates and inflation rates using pair-wise correlation, and it was discovered that covid-19 rate caused changes in general price level. The study further established the inflationary characteristics of covid-19 on commercial properties returns. The study therefore utilized Ordinary Least Squares, Augmented Dicker Fuller (ADF), Engle Granger cointegration and cointegrating regression analysis. The result of FMOLS revealed that commercial properties in Lagos are completely hedged against actual and expected inflation rates while other were perversely and partially hedged against covid-19 driven inflation. The study therefore found that effect of disruption caused by covid-19 pandemic in the economy has not fully manifested in the real estate market, but there is possible future far-reaching effect if measures are not put in place. Property market is thereby susceptible to loss of value by continue locking down the economy over a long period.

Keywords: commercial properties, hedging capacity, inflation, rental price

<sup>1</sup> babatunde.wahab@kasu.edu.ng; Tel. +2347032907744

<sup>2</sup> duwas11@gmail.com; Tel. +2348055837352

<sup>3</sup> mamman16@gmail.com; Tel. +2348065350020

<sup>4</sup> sikemicharles@gmail.com; Tel. +2348038206872

<sup>5</sup> zakaridodo@gmail.com; Tel. +2348059126053

## INTRODUCTION

The World Health Organization (WHO) in March 11, 2020 had therefore characterized COVID-19 as a pandemic, pointing to over 3 million cases and 207,973 deaths in 213 countries and territories. The infection has not only become a public health crisis but has also affected the global economy. Significant economic impact has already occurred across the globe due to reduced productivity, loss of life, business closures and trade disruption (Pak et al, 2020). Commercial properties as investment good and critical assets to real estate investors, apart from been an income generating assets, it is regarded as wealth generating asset of a nation (Belo & Agbatekwe, 2002). Apart from been a critical asset nation's development, commercial properties have been viewed as an integral part of national economy that provide alternative investment options in growing economy, and due it significant contribution to economic nation's development, it has become influential asset to national income through the real estate sector (Fraser 1993; Belo & Agbatekwe, 2002). Also, over the years, commercial properties have been professed to have power to protect investment's fund over eroding power of inflation therefore investors want to be sure that investing in commercial investment would cover a range of risks associated with real estate investment (Amidu & Aluko, 2006), every rational investors would prefer more returns on their real invement over and above systematic and unsystematics risks associated real estate market (Olaleye, 2008). Government at every level has recognized economic importance of investing in commercial properties as major source revenue to local government through rating (Aluko, 2005)

However, real estate has been seen as an hedge against dearth of inflation but fears have recently been expressed about the development in the economic due global pandemic (covid-19) that whether the effect of this economic disruption would have a far reaching effect on real estate investment. During the lockdown phase, the covid-19 pandemic and related lockdown measures affect the supply and demand of certain products through their prices. the supply of consumer product was therefore disrupted which triggered the general increase in price level or inflation rate (Pak et al, 2020). Ehsan, et al., (2020) noted that potential drivers of inflation amid covid-19 pandemic during the lockdown and reopening phases are characterized by restrictions in mobility and disruptions in potential supply. Ehsan et al., (2020) further proved that there was no evidence of upward movement in actual inflation but there existed a rise in variance of expected inflation thereby indicating uncertainty and potential risk of unexpected inflation. According to Alagidede and Panagiotides (2007) observed that 1% rise in price of good in Nigeria causes 0.12% rise in general stock returns thereby providing partial hedge against inflation. Currently in Nigeria, inflation has been trending on double digit rate and bank lending rate has also be trending on double digit (CBN, 2019), therefore real property investors need to ascertain the level of security of the investment. Most of the real property investors in Nigeria are risk-averse, in other word, would like to have more returns on the investment at less risk (Olaleye, 2008), this is therefore attributed to the fact that Nigeria real property market is characterized as immature market because of naïve decision-making by property stakeholders.

It is really against the background of economic disruption caused by covid-19, volatility and recession that has recently characterized the economy that left the investors in a state of fear about the security of the real estate investment. Therefore the extent of disruption in commercial property market is therefore required a careful investigation. Over the years, commercial properties investment has been characterized as a hedge the dearth of inflation by providing a protective device for investors 'capital against eroding power exhibited by general increase in consumer price index (CPI) (Amidu & Aluko, 2006). Recently, the phobia of many investors has been construed that whether real property is actually a hedge against the recent economic instability, recession and the presence of covid-19 pandemic that characterized the economy. The dynamic effect of covid-19 is more felt in emerging economy of Nigeria where supply disruption combined with weak currency therefore triggered the general increase in price level (inflation) during and after containment period. It is against this background that this study seeks to answer this question 'to what extent has the impact of covid-19 driven inflation arising from an increase in consumer price index been hedged from eroding the value of commercial properties in Lagos? 'with a with a view to restoring the confidence of investors in real estate investment.

## LITERATURE REVIEW

### **Covid-19 and inflation in the economy**

Ehsan et al., (2020) examined the dynamic effect of inflation during the COVID-19 pandemic between phases (lockdown and reopening phases) in advanced and developing economy in Europe and America. The study found that early evidence of increase in actual inflation from advanced and emerging market economies but was not in broader perspective, thereby the measure of inflation showed no evidence of increase in actual inflation but there was rise in variance of unexpected inflation indicating significant of uncertainty. Brunnermeier, Merkel, Payne and Sannikov (2020) studied inflationary and deflationary pressure amid covid-19. The study found that initially deflationary forces played significant role due idiosyncratic risk and recovery brought through government lending and other measures lead to excessive inflation.

The lockdown phase entails the combination of substantial shocks in both demand and supply, and the pandemic therefore leads to deflation, disinflation, or higher inflation. As falling in aggregate demand to heightened uncertainty and reductions in incomes and liquid wealth in advanced and emerging economies has lead to deflationary pressures (Pak et al., 2020). Conversely, inflationary pressures may arise from increases in production costs, due to interrupted supply chains and to the impact of social distancing restrictions on labour supply especially in emerging economy. By shutting down sectors of the economy, the Great Lockdown has led to changing patterns of demand that translate into shifts in the degree of market power firms exercise, which will affect equilibrium inflation. These pressures in inflation are differed across sectors and nations. Sectoral inflation heterogeneity in turn is likely to feed through to heterogeneous inflation experiences across households. Conclusively, The dynamics could, however, be quite different in emerging markets (EMs). Supply disruptions combined with currency depreciations might lead to an increase in inflation even during the containment period.

### **Inflation and real estate investment: the empirical studies**

Several studies have linked inflationary pressure to real estate market both in Nigeria and abroad, such studies together with their findings are summarized as follows:

In the study carried out by Voigtlander and Demary (2009) while analysing the real estate hedging capacities across selected states in Europe and America, it was discovered that real estate's equities failed to provide a protective power against inflation. Xiarong and Sherwood (2010) examined inflation hedging in real estate market in china between 2000 and 2008 using autoregressive technique. It was found that long run equilibrium between changes in real estate prices and inflation showed no evidence of relationship and concluded Chinese real estate market had no good protective power against inflation. In a similar study conducted by Leung (2010) on commercial (office and shop) and industrial properties hedging abilities in Australia between 1984 and 2008, it was discovered that property assets (commercial and industrial) provided a complete hedge against inflation. Hartzell and Webb (2010) while analysing the relationship between commercial real estate and inflation during the period of low and high occupancy in United States, it was therefore found that real estate maintained a balanced hedge against expected inflation and partially relationship with unexpected inflation. Odu (2011) while studying commercial real estate hedging capacity in Lagos using Ordinary Least Square (OLS), it was discovered that commercial real estate returns was perversely hedged actual inflation in some selected areas and completely hedged against actual inflation in some selected areas. In the same vain, Anyakora, et al., (2012) also carried out a similar study in Lagos Metropolis (Ikoyi, Victoria Island, Lagos Island, Apapa and Surulere), it was found that inflationary hedging capacities of commercial real estate varied across geographical neighborhoods. . Osagie, et al., (2012) studies the evidence of commercial properties as a good hedge against inflation in Lagos and discovered that while office properties provided a good hedge, shop properties failed to provide a good hedge.

Umeh and Oluwasore (2012) ascertained uncertain inflation hedging capacities of residential investment returns between 2002 and 2014. Ordinary least squares indicated that hedging capacities vary across the geographical sub-markets, such that residential investment returns failed to hedge actual inflation across the geographical areas; other geographical sub-market provided a complete and partial hedges against inflation. Amonhaemanon, et al., (2013) examined inflation hedging capacity in commercial real estate in thailand between 1987 and 2011. It was found that commercial real estate returns had positive relationship with unexpected inflation over the period. The structural changes in the economy as control measure showed that the relationship between inflation and commercial real estate returns change under certain economic environment. Ogunba et al., (2013) analysed the characteristics of inflationary hedging of commercial real estate in Ibadan. Using consumer price index and 91-day Treasury bill as a proxy for actual inflation and expected inflation respectively, it was discovered through ordinary least squares that commercial real estate had poor hedge against actual inflation, partially hedged against unexpected and completely hedged against expected.

Amonhaemanon et al., (2014) examined ex post and ex ante inflationary hedging abilities of real estate in Thailand, the further discovered that real estate returns had positive relationship with ex post and unexpected inflation and real estate provided a super hedge against inflation. It was therefore concluded that relationship between real estate and inflation depends on the state of economy especially in the period of financial crisis. This finding updated the finding of Amonhaemanon et al., (2013). Dabara (2014) while investigating the inflation-hedging characteristics in Gombe residential market of Nigeria between 2003 and 2012. It was found that residential investment market in Gombe was completely hedged expected inflation, partially hedged against actual inflation while perversely hedged against unexpected inflation. Umeh and Oluwasore (2015) in another similar study of hedging capacity of residential market in Ibadan using OLS, the result found that residential market failed to provide a complete hedge against actual inflation while providing complete hedge against expected inflation and partially hedge against unexpected inflation. Wahab et al., (2018) conducted full study of residential hedging capacities in Abuja residential market by examining both short and long runs inflationary characteristics. It was discovered that the use of OLS could not explicitly provide a complete the hedge across the markets, and further analysis long run hedging capacities provided a complete hedge across all the markets.

Conclusively, the variance in results of the above studies suggests the need to constantly investigate the inflation hedging capacities of real estate investments from time to time and across different regions or areas, and recent disruptions in supply combined with currency depreciations associated with covid-19 pandemic might lead to an increase in inflation even during the containment period which required careful investigation. In an emerging economy like Nigeria where market equilibrium is difficult to attain, the advent of covid-19 had posed a threat to wealth asset (commercial property) of the Nation as the condition of financial market in is worsened by weak currency and covid-19 driven inflation which resulted in loss value of assets. This has therefore posed threat to real estate market. Finally, since the effect of covid-19 pandemic has a link to inflation in the economy in many studies (Ehsan et al., 2020; Pak, et al., 2020; Brunnermeier, et al., 2020. Therefore, the need to investigate the extent of hedging capacity of commercial property investment against covid-19 driven inflation during lockdown and reopening phases has become sacrosanct to real estate investors.

## METHODOLOGY

The primary data adopted for this study comprised of computed monthly returns on office commercial office properties in Lagos (March 2020 to March 2021) from registered estate firms. Secondary data comprised of monthly consumer price index which is used as a proxy for actual inflation and 90-day Treasury bill which is also used as a proxy for expected inflation rate according to Ogunba et al., (2013), there information were sourced from National Bureau of Statistics (NBS), while unexpected inflation is the different between actual inflation and expected inflation. Secondary data on the rate of monthly covid-19 infections in Lagos was used for the study. The study adopted correlation to test the strength of relationship between the rate of monthly covid-19 infections and inflation rates, conintegrating regression using Fully Modified Least Squares (FMOLS) to establish

both short and long run inflationary characteristics of house prices respectively. FMOLS used to estimates relationships in cointegration analysis by modifying ordinary least squares (OLS) to account for both serial correlation and endogeneity in the regressors. It is therefore asymptotically related to methods like Johansen (1988). FMOLS identifies long-term relationship just like Johansen method and used to test for cointegration by examining stationarity test through Augmented Dicker Fuller (ADF). The study applied Augmented Dicker Fuller (ADF) unit root test to determine the extent of stationarity of the data. The test of stationarity of the series was carried out for the study in order to detect the presence of unit root (non-stationary) or not, and to determining the order of integration of the variables in the model presented in equation 1.

$$\Delta Y_t = \beta_0 + \beta_1 Y_{t-1} + \sum_{i=1}^k \pi_i \Delta Y_{t-1} + U_t \text{ eq1.}$$

Where  $Y_t$  represents vector of time series,  $t$  represent  $t_i + me$ ,  $U_t$  represents the error terms and  $\pi$  represents the coefficient matrix of the variables,  $\Delta$  represents differences in variables.

The study adopted a sampled size model developed by Frankfort-Nachmias (1996) to determine appropriate sample size from large number of commercial office properties across the selected areas and this model is purposely adopted when the population is large. This model is therefore presented and described in equation 2.

$$n = \frac{z^2 pqN}{e^2(N - 1) + Z^2 pq} \text{ eq. 2}$$

Where  $N$  is population size,  $n$  is sample size,  $p$  at 95% confidence level of the target population

$$q = 1-p, e = \text{Acceptable error } Z = 1.96$$

The model for commercial real estate returns ( $R$ ) is described as in the equation 3.

$$R = \frac{p_t - p_{t-1}}{p_{t-1}} \text{ eq. 3}$$

$R$  is commercial office returns indices,  $P_t$  is commercial office returns at end of period  $t$ ,  $P_{t-1}$  is the commercial office returns beginning of period  $t$ . The decision rule for hedging capacities of real estate is described in table 1.

**Table 1 Decision rule**

Hedges in Real Estate	Decision rule
A complete hedge against inflation	If $\beta$ is not significantly less than 1 (i.e. between 1 and 0.5)
A partial hedge against inflation	If $\beta$ is significantly less than 1 (i.e. between 0.4 and 0.1)
Zero hedge against inflation	If $\beta$ is not significantly different from zero. 0.001-0.000
A perverse hedge against inflation	If $\beta$ is negative



## PRESENTATION OF RESULTS

Figure 3.1 shows the rising cases of COVID-19 pandemic in the study area. the trend revealed that from February 28th 2020 to April 28th 2020, there was slow raising cases covid-19, and after April 28th, there was high rising in number of cases recorded . This was attributed to poor response of government to the pandemic; in term of safety guide and measures against the spread. The sharp raising recorded after April 28th was associated to the fact that the lack preparedness in the case of pandemic. The rising continues till September 19th 2020 and after which there was slow rising in number of cases. This is therefore attributed high of compliance to lock down measures. The gradual reopening from lockdown had suddenly led to sharp rising in number of cases from November 30th till date. The implication is that the global and local economy and financial markets have been severely affected due to the significant reductions in income, a rise in unemployment, and disruptions in the transportation, service, and manufacturing industries caused by the covid-19 pandemic. Consequently, the correction of the damage in the economy required a slow adjustment over a period.

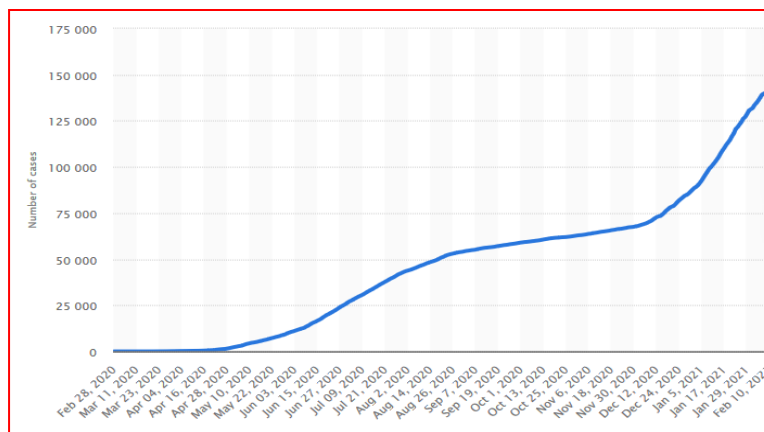

Figure 1: Cumulative Number of Confirmed Coronavirus Cases (COVID-19) in Nigeria from February 28, 2020 to February 10, 2021

Source: Computed From NCDC Monthly Report

Figure 2 revealed the monthly trend in inflation rates between February 2020 and February 2021. The figure presented the high trend in inflation during lockdown phase (February 2020 to October, 2020) where the general price level experienced downward trend due to various lockdown measures made by the government, while the period reopening (November, 2020 to February, 2021) suddenly experienced rise due to government removal of various measures of palliative made during the lockdown. The study utilized consumer price index as a proxy for actual inflation, 90-day Treasury bill as a proxy for expected inflation. The difference between expected and unexpected inflation is unexpected inflation rate. At the beginning of the lockdown, there was sharp rise in actual and unexpected inflation rates from February, 2020 to April, 2020 due to lockdown. But the partial reopening from May, 2020 to October 2020 made the prices to come down due to increase in production of good and partial movement, but sudden rise in number of recorded covid-19 cases in November 2020 and December 2020 restricted the production goods and give rise to general increase in both expected inflation and after which actual inflation followed suit. Actual and expected inflation rates have started rising since December 2020 up till February 2021. The implication is that

there is instability in the prices due to covid-19 and which has caused disruption in the market.

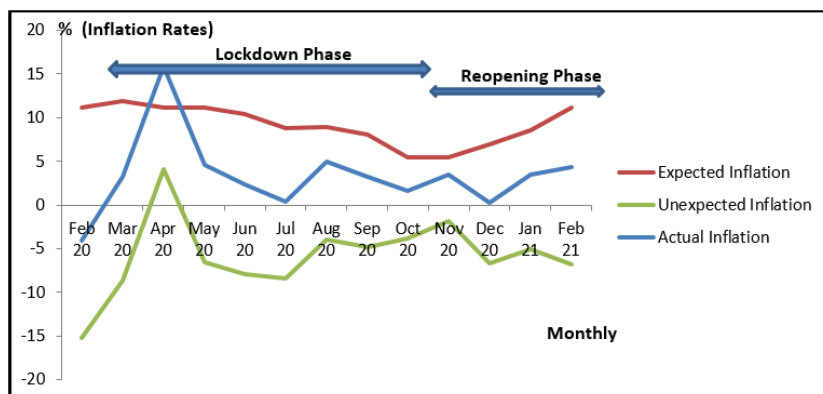

Figure 2: Monthly expected, unexpected and actual inflation rates amid Covid-19 (From Feb; 2020 to Feb; 2021)  
 Source: Field survey, 2021.

The result in Table 2 showed the correlation between inflation rates and covid-19 rate of infections. The result revealed that there is positive insignificant correlation between actual inflation and covid-19 rates at 0.204 which indicates direct relationship. Expected and unexpected inflation rates maintained positive significant correlation with covid-19 rates at 0.557 and 0.590 respectively. This thereby suggests a direct relationship with covid-19 rate. By implication, covid-19 rate is related to general inflation rate in the economy, as a result, linking covid-19 to property market through inflation with real estate market become the premise of this study.

Table 2: Pairwise matrix correlation between inflation rates and Covid-19 rate

		Actual Inflation	Expected Inflation	Unexpected Inflation	Covid-19 rate
Actual Inflation	Pearson Correlation	1			
	Sig. (2-tailed)				
	N	13			
Expected Inflation	Pearson Correlation	.220	1		
	Sig. (2-tailed)	.469			
	N	13	13		
Unexpected Inflation	Pearson Correlation	.870**	-.288	1	
	Sig. (2-tailed)	.000	.340		
	N	13	13	13	
Covid-19 rate	Pearson Correlation	.204	.557*	.590*	1
	Sig. (2-tailed)	.504	.048	.039	
	N	13	13	13	13

Figure 3 showed the movement in commercial property returns between February 2020 and February 2021. There was upward and fluctuated movement in returns during the lockdown phase ( February, 2020 to October, 2020). The period of

reopening (November, 2020 to February, 2021) showed downward movement in returns. The study suggested that there was distortion in the market that gives rise to volatility in the trend in returns on commercial real estate. From February 2020 to May 2020 there was sharp fall in returns due to general lockdown in the country. A partial reopening phase from May 2020 leads to sharp rise in returns from May 2020. After which there was fluctuated decrease in returns up till December when there deep fall in returns across the markets and after there was sharp rise in returns from January 2021 to February 2021. This instability in returns is attributed to disruption caused by covid-19 pandemic in economy.

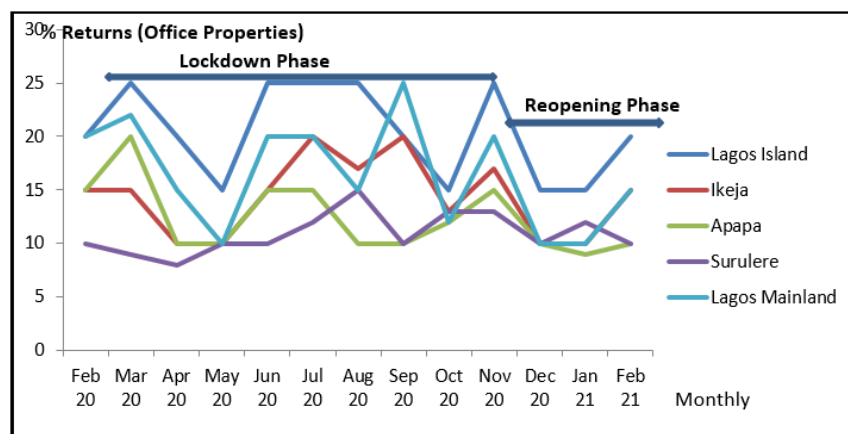

Figure 3: Monthly returns on commercialized office properties in Lagos amid Covid-19 (From Feb; 2020 to Feb; 2021)

Table 3 reveals the result of stationerity test (unit root test) conducted through Augmented Dicker Fuller (ADF) for all the variables employed for the study. One of the properties of time series data is that it must stationary over a period, in other word; it must have no unit root before it can be used or considered suitable in any econometric analysis. Therefore, the result of ADF unit root test revealed that actual, expected and unexpected inflation were stationary at first-order difference, only return indices commercial office properties across the markets were stationery at level. The implication of this test is that the time series data employed for this study is suitable and appropriate for further analysis. Technically, it implies that the time series variables free from unit root.

**Table 3: Stationarity or unit root test**

Variables	Critical ADF @0.05	Computed ADF t-Statistics	Prob.*	Order of Integration
Δ Actual inflation	-3.042012	-4.301672	0.0131	I(1)
Δ Expected Inflation	-3.023441	-4.488337	0.0038	I(1)
Δ Unexpect inflation	-3.014522	-3.510113	0.0156	I(1)
Lagos Mainland(R)	-3.031345	-4.889604	0.0014	I(0)
Lagos Island (R)	-3.030221	-4.179963	0.0082	I(0)
Ikeja (R)	-3.042901	-3.987214	0.0215	I(0)
Apapa (R)	-3.030271	-4.779778	0.0029	I(0)
Surulere (R)	-3.030271	-3.158997	0.0389	I(0)

Table 4 reveals the outcome of Engle granger cointegration test used to determine the long run relationship between commercial office returns and inflationary characteristics of covid-19. The result in Table 3 shows tau- statistic and z-statistics as well as respective p-values. The result of the statistics shows the evidence of two or more cointegrating equations at 0.05(5%) level of significance therefore the study rejects null hypothesis of no cointegration among the variables at 5% through z-statistics across the selected markets in Lagos. In other word, with a given sample size probabilities and critical values, therefore there is a long run convergence among the variables across the market locations. In other word, there is long run relationship between commercial office property returns and inflationary characteristics of covid-19 pandemic. This finding is consistent with that Wahab et al., (2018) It can therefore be said that inflationary characterized by covid-19 pandemic has long run relationship with commercial office property market in selected commercial office centers (Lagos mainland, Lagos Island, Ikeja, Apapa and Surulere) in Lagos.

**Table 4: Engle Granger Cointegration Test**

Market	Dependent	tau-statistic	Prob.*	z-statistic	Prob.*
Lagos mainland	Lagos mainland log	-3.879911	0.1469	-29.78126	0.0048
	Actual_Inflation_Index	-2.666152	0.1377	-23.85091	0.0122
	Expected_Inflation_Index	-3.567676	0.1451	-25.02675	0.0105
	Unexpected_Inflation_Index	-3.755981	0.1470	-23.11275	0.0129
Lagos Island	Lagos Island log	-5.021218	0.0338	-21.67113	0.0255
	Actual_Inflation_Index	-2.977603	0.3907	-24.72358	0.0000
	Expected_Inflation_Index	-2.331006	0.5612	-11.77025	0.6118
	Unexpected_Inflation_Ind	-3.415022	0.3226	-13.13251	0.3448
Ikeja	Ikeja log	-2.088602	0.4550	-11.82028	0.4415
	Actual_Inflation_Index	-3.880022	0.2131	-22.84788	0.0224
	Expected_Inflation_Index	-3.799555	0.1194	-21.85511	0.0141
	Unexpected_Inflation_Ind	-3.719802	0.2291	-21.88861	0.0139
Apapa	Apapa log	-2.114722	0.8610	-6.558291	0.8174
	Actual_Inflation_Index	-3.330511	0.4155	-21.99843	0.0261
	Expected_Inflation_Index	-3.221022	0.4242	-20.81727	0.0252
	Unexpected_Inflation_Ind	-3.154555	0.4338	-20.98133	0.0258
Surulere	Surulere log	-7.335491	0.0053	-24.44900	0.0035
	Actual_Inflation_Index	-3.664162	0.3501	128.5624	1.0000
	Expected_Inflation_Index	-2.385208	0.6695	-7.393662	0.7702
	Unexpected_Inflation_Ind	-3.885625	0.2977	-90.76532	0.0000

Table 5 shows the outcome of analysis of cointegrating regression carried out. The result of cointegrating regression showed the hedging capacity of commercial office property amid covid-19 in Lagos. It has been proved that the use of ordinary least square could not reveal the long run hedging capacity of commercial real estate (Wahab et al, 2018). Therefore the use of fully Modified Ordinary Least Square (FMOLS) revealed the true characteristics of long run hedging capacity of commercial office properties. In all the selected markets, commercial official returns is completely hedged against actual and expected inflation, this finding is consistent with Ogunba et al., (2013) and Wahab et al., (2018). This finding further indicates that the market independent of negative effect of inflation caused by covid-19 disruptions in the economy, and therefore the real estate investor's returns is thereby secured from eroding. Commercial office properties in Lagos

Mainland and Lagos Island are partially hedged against unexpected inflation arose amid covid-19 pandemic, this finding is found consistent with Hartzell and Webb (2010).

**Table 5: Cointegrating Regression Analysis (FMOLS Estimates)**

Market	Variable	Unstandardize d Coefficient	Std. Error	Beta	R-Square	Prob.	Hedging Status
Lagos mainland	(Constant)	38.05	9.549		.801	.000	
	Actual inflation $t-1$	.520	.132	.889		.000	Complete Hedged
	Unexpected inflation $t-2$	.310	.136	.225		.005	Partial hedged
	Expected inflation $t-1$	.601	.122	.894		.000	Complete Hedged
Lagos Island	(Constant)	44.37	7.994		.874	.008	
	Actual inflation $t-1$	.675	.140	.661		.000	Complete Hedged
	Unexpected inflation $t-2$	.818	.345	.131		.006	Partial Hedged
	Expected inflation $t-1$	.677	.022	.981		.000	Complete Hedged
Ikeja	(Constant)	-58.84	10.246			.025	
	Actual inflation $t-1$	.482	.063	.977	.891	.000	Complete Hedged
	Unexpected inflation $t-2$	.465	.103	.686		.003	Complete Hedge
	Expected inflation $t-1$	.677	.083	.966		.000	Complete Hedged
Apapa	(Constant)	36.43	8.039		.799	.005	
	Actual inflation $t-1$	.633	.072	.908		.000	Complete Hedged
	Unexpected inflation $t-2$	-.473	.296	-.329		.027	Perverse hedged
	Expected inflation $t-1$	.470	.063	.861		.000	Complete Hedged
Surulere	(Constant)	55.07	11.071		.750	.010	
	Actual inflation $t-1$	.761	.040	.967		.000	Complete Hedged
	Unexpected inflation $t-2$	-.076	.767	-.232		.161	Perverse hedged
	Expected inflation $t-1$	.706	.048	.894		.000	Complete Hedged

Fully Modified Least Squares (FMOLS)

This further indicates that, the investors in Lagos Mainland and Lagos Island markets can break-even in advent of sudden rise in general price level caused by lockdown in the economy due to covid-19 pandemic, in other word, the value of investment cannot be eroded below the market value. Only commercial office market in Ikeja provided a complete hedge against unexpected inflation that arose amid covid-19 pandemic. Commercial office properties 'in Apapa and Surulere are perversely hedged against unexpected inflation that arose due to disruption in the economy caused by covid-19 pandemic. In other word, investors 'in these two

markets (Apapa and Surulere) have high possibility of losing their investment because in the case of sudden rise in inflation in the economy due to covid-19 pandemic would erode the value of investment, in that, the markets are not matured enough to provide an hedge. Finally, The overall influence of inflation rates in the economy caused by covid-19 pandemic on commercial office returns across the markets ranges between 89.1%-75.0%.

## IMPLICATION OF FINDINGS

From the findings, the rate of covid-19 infection has positive relationship with inflation rates, in other word, over the period of study it can be deduced that covid-19 pandemic granger causes changes in inflation rates due to disruption in the economy. This is because, the study has demonstrated upward and downward movement in the rate of inflation caused by economic disruption associated with covid-19. By implication, all the stakeholders in the real estate sectors must be cautioned when investing into the market. The fact that real estate is hedged against inflation as it was construed theoretically still required empirical evidence because certain conditions could affect the efficacy of the theory such as general instability in the economy, economic recession and other unforeseen circumstances such as war and pandemic like covid-19. The result expressly showed the market maturity in term of its hedging characteristics in some the selected markets. Generally, all the selected markets provided a complete hedge against the eroding power of actual and expected inflation which by implication making the market to be independent of dearth of covid-19 driven inflation, in other word, the value of real estate investment market could not be eroded and investors is therefore protected against the loss of investment. Conversely, while some the selected market (Lagos Mainland and Lagos Island) were found to be partially hedged against unexpected inflation, other selected market (Apapa and Surulere) were perversely hedged against unexpected inflation. By implication, being partially hedged the market is still protected but to certain degree immunity. This therefore means that real estate market is still developing in term hedging characteristics, and in this market, investors must be economically guided. Also being perverse, the market value of real estate investment is threatened and there is possibility of unexpected inflation eroding the value of investment, and investors must carry out careful analysis of the investment. One the selected market (Ikeja) said to have provided a complete hedged against actual, expected and unexpected covid-19 driven inflation.

## CONCLUSION

It is therefore construed from this study that disruption caused by covid-19 driven inflation has not fully affected the commercial property market, this is because while markets provided high degree of immunity against the eroding power of covid-19 driven inflation, some other market provided little and others are been threatened. Therefore, the effect is not far-reaching, but there is possible future far-reaching effect if palliative measures are not put in place to subvert the effect. the adjustment and re-structuring as well as various measures taken by the government to prevent adverse effect of covid-19 pandemic on the economy, there

is need to continuously investigates the market to unravel the situation and provide empirical guide to the real estate investors from time to time.

## REFERENCES

- Alagidede, P., Panagiotidis, T. (2007). Can common stocks provide a hedge against inflation? Evidence from African countries, *Review of Financial Economics* 19 (2) 91-100.
- Aluko, B. T. (2005). Building Urban Local Governance Fiscal Autonomy Through Property Taxation Financing Option. *International journal of strategic management*.
- Amidu, A. R., & Aluko, B. T. (2006). Performance Analysis of Listed Construction and Real Estate Companies in Nigeria. *Journal of real estate portfolio management* , 177-185.
- Amonhaemanon, D., De Ceuster, J. K., Annaert, J., & Long, I. H. (2013)The Inflation-Hedging Ability of Real estate Evidence in Thailand: 1987-2011. *International Conference on Applied Economics (ICOAE) 2013. Procedia Economics and Finance* 5 ( 2013 ) 40 – 49.
- Amonhaemanon<sup>1</sup>, D., Annaert, J., & De Ceuster, J. K. (2014) The Inflation-Hedging Ability of Real Estate Thai Evidence: 1987-2011 *Advances in Management & Applied Economics*, vol. 4, no.1, 2014, 1-15.
- Anyakora, M., Idowu, O., Osagie, J., & Omirin, M. (2012) Inflation Hedging Capacity of Commercial Real Estate Investment (Case Study of Lagos- Nigeria Property Market). *Journal of Contemporary Issues in Real Estate*, 2(1), 1-12.
- Brunnermeier, M., Merkel, S, Payne, J., & Sannikov, Y. (2020) COVID-19: Inflation and Deflation Pressures: <https://fred.stlouisfed.org/series/>, June 14, 2020. 15th September, 2020
- Dabara, D. I. (2014). The Inflation-Hedging Performance and Return Characteristic of Residential Property Investment in Gombe, Nigeria. *AIR* 3(1), 71-83.
- Ehsan, E., Deniz, I., & Soledad, M, (2020). The Impact of COVID-19 on Inflation: Potential Drivers and Dynamics. *IMF Research*, 2020.
- Hartzell, D. J., & Webb, R. B. (2010). Commercial real estate and inflation during periods of high and low vacancy rates. Available from [http://www.eri.org/research/abstract\\_pdf/wp14.pdf](http://www.eri.org/research/abstract_pdf/wp14.pdf)
- Leung, A. (2010). Commercial property as an inflation hedge; An Australian perspective. *Journal of pacific rim research* 16(1), 97-115.
- Odu, T. (2011). An analysis of relative inflation hedging capacities of prime commercial properties in Lagos. *Global Journal of human social science*, 11(10), 42-51.
- Ogunba, O., Obiyomi, O. & Dugeri, T. (2013). The Inflation Hedging Potential Of Commercial Property Investments in Ibadan, Nigeria. *West Africa Built Environment Research (WABER) Conference Accra, Ghana*, 1101-1111.
- Olaleye, A. (2008). Property Market Nature And The Choice Of Property Portfolio Diversification Strategies: The Nigeria Experience. *International Journal of Strategic Property Management* , 35–51.
- Osagie, J., Gambo, Y., Anyakora, M., & Idowu, O. (2012). Are Commercial Properties A Good Hedge Against Inflation? Evidence from slected commercial centres in Lagos. *ATBU journal of contemporary issues in Real Estate*, 5(1).

- Pak, A., Adegboye O. A., Adekunle, A. I., and Rahman, K. M., Emma, S., McBryde<sup>1</sup> and Damon, P., & Eisen<sup>1</sup> (2020) Economic Consequences of the COVID-19 Outbreak: the Need for Epidemic Preparedness *Frontiers in Public Health* | www.frontiersin.org May 2020 | Volume 8 | Article 241
- Umeh, O. L., & Oluwasore, O. A. (2015). Inflation hedging abilities of residential properties of selected areas of Ibadan metropolis, Nigeria. *ATBU journal of environmental technology* 8(2).
- Voigtlander, M. & Demary, M. (2009). The inflation hedging properties of real estate: A comparison between direct investments and equity returns. Available from <http://www.eres2009.com/papers/5Dvgtlaender.pdf>
- Voigtlander, M., & Demary, M. (2009, May 20). The Inflation Hedging Properties of Real Estate: A Comparison between Direct Investments and Equity Returns. Retrieved October 22, 2010, from ERES Conference 2009: [http://www.eres2009.com/papers/5Dvoigtlaender.p df](http://www.eres2009.com/papers/5Dvoigtlaender.pdf)
- Wahab, M. B., Ola, O. S., Sule, A. I., Adepoju, A. S., & Dodo, Z. I. (2018) Inflationary Hedging Capacity Of House Price Returns In Emerging Economy Of Nigeria. *LAÜ Sosyal Bilimler Dergisi (IX-II)*: 152-166
- Xiaorong, Z., & Sherwood, C. (2010). The Inflation Hedging Ability of Real Estate in China. *Journal of Real Estate Portfolio Management*: 2010, 16(3), 267-277.





# INVESTIGATING THE EFFECT OF CURING METHODS ON THE STRENGTH PROPERTIES OF CONCRETE

Francis Kwesi Nsakwa Gabriel-Wetley<sup>1</sup> and Humphrey Danso<sup>2</sup>

<sup>1</sup>*Basic Design and Technology, Islamic Research School, P. O. Box OH 387, Kasoa, Central Region, Ghana.*

<sup>2</sup>*Construction and Wood Technology Education, Akenten Appiah-Menka University of Skills Training and Entrepreneurial Development, P. O. Box 1277, Kumasi, Ghana.*

In the hot humid climate, the method of curing used is critical in achieving the needed strength of concrete for construction application. This study sought to investigate how the different curing methods can influence the compressive and flexural strengths of concrete in the hot humid climate. The targeted compressive strength of the concrete at 28-day of curing was 20 N/mm<sup>2</sup>. Plain concrete cubes and beams were prepared with a mix ratio 1:1.5:3 by weight and 0.6 water-cement ratio. A total of 120 concrete specimens were prepared, comprising 60 each for cubes and beams. Four different curing methods (immersion, wet jute sack covering, plastic sheet covering and water sprinkling) were adopted. The concrete specimens were tested on 7, 14, 21, 28 and 56 days of curing. It emerged that the immersion curing method recorded the highest compressive values of 23.43 and 25.83 N/mm<sup>2</sup>, respectively for the 28 and 56 days curing at a significant difference of 16% increase strength over the sprinkling method. It was also found that the immersion curing method obtained the highest flexural strength of 2.81 and 3.49 N/mm<sup>2</sup>, respectively for the 28 and 56 days curing at 14% increase strength over the sprinkling method. The study, therefore, concludes that the use of appropriate method of curing can have an effect on the flexural and compressive strengths of the concrete, and therefore recommend the adoption of immersion curing method, especially in the hot humid climate for precast and laboratory-based concrete units 'production.

Keywords: compressive strength, concrete, curing method, flexural strength, slump tests

## INTRODUCTION

Cement and concrete products require curing for development of strength, durability, and other properties. This is because cement and concrete products require hydration process in initially damp condition to allow for optimum development of their properties. Olanitori (2006) described concrete as a product which constitutes the mixture of binding agent, fine aggregate, coarse aggregate and an appreciable amount of water. In some instances, admixtures are added to

---

<sup>1</sup> geewett4@gmail.com

<sup>2</sup> hdanso@uew.edu.gh

the mixture to improve the concrete's properties such as colour, setting rate and workability (Surahyo, 2019). Among all the major characteristics of cement and concrete products namely, durability, workability, permeability and strength, the latter is considered the most valuable and desirable. This suggests that careful attention must be given to these factors that influence the concrete's strength. The curing of concrete in the right environment and condition, after the placement of concrete contributes to obtaining quality concrete, especially in the early stages of hardening.

The durability and quality of concrete depends on several factors. It is not limited to the characteristics or quality of the constituents of the concrete but also depends on factors such as the methods of preparation, placing, curing and environmental conditions to which it is exposed over its service life. Proper curing of concrete is requisite in developing its optimum properties. Sufficient supply of moisture during curing is essential in ensuring good hydration. This reduces the porosity of the concrete and helps attain the desired durability and strength (Federowicz et al., 2020; Rahman et al., 2012). According to a study of Mamlouk and Zaniewski (2006), concrete allowed to only dry in the air without proper curing can only gain up to 50% of its desired strength when adequately cured. The authors further stated that the concrete will attain 60% of the desired strength if cured for only three days and will gain 80% of its desired strength if cured for only seven days. Improper curing leads to insufficient moisture in the concrete, which results in the development of cracks, reduced strength as well as the long-term durability (Zain et al., 2000; Wojcik & Fitzgarrald, 2001; Rao et al., 2010).

According to Nurrudin et al. (2018) and Usman and Nura Isa (2015), curing has significant influence on the durability and properties of concrete and geopolymer since it contributes to the hydration of cement in the mix. Without moisture, the hydration of cement virtually ceases when the relative humidity of reduces below 80%. Nahata et al. (2014) also posited that, hardened concrete's properties are greatly affected by the method used in curing it. The sensitivity of concrete to curing is influenced by methods used in curing. There are several methods of curing concrete such as ponding (immersion), dry-air-curing, fogging (sprinkling), saturated wet covering, curing compound, plastic sheet, self-curing concrete and jute sack (wet covering), wrapped curing, wet gunny bags curing, etc. The different curing methods are employed based on the construction method and the nature of the project as well as the site conditions (Boakye et al., 2014). According to Liu et al. (2020) the effect of curing methods of on the properties of concrete have been relatively less studied. Despite these numerous methods used in curing to improve concrete properties, concrete structural failure and collapse is on the increase. Moreover, in spite of the extensive publications on the concrete curing methods and their effect on concrete strength properties in other countries, the topic has not been researched into detail in hot humid climate. This study therefore investigates the influence of the different curing methods on the strength properties of concrete in the hot humid climate, particularly in controlled environment for precast and laboratory-based concrete units.

## MATERIALS AND METHODS

### Materials

Crushed granite rock aggregate procured from a commercial quarry company at Ntensere in the Ashanti Region, Ghana was used for the study which had 20mm maximum size of aggregate. The coarse aggregates used was clean, free from waste and impurities. Natural sand is usually used as a fine aggregate in a concrete mix, however, in this study quarry sand was used as a replacement of natural sand. The quarry sand was air-dried to remove the moisture, in order not to change the chosen water cement ratio. The drying of the quarry sand was done at room temperature condition. The quarry sand was sieved using BS 3.75mm sieve to obtain the required sizes and to also remove any foreign materials that can influence the quality of the concrete.

Super Rapid Ordinary Portland Cement (class 32.5 R) produced by Ghana Cement Company Limited (GHACEM) that conformed to BS EN 197-1 (2011) was used in the study. It was procured from a retailing outlet prior to the experimental work and was kept in the laboratory, in a dry place to prevent premature hydration that could lead to caking of the cement. Tap water from Ghana Water Company supplied to the College of Technology Education, Kumasi, laboratory of the Construction Technology was used for the study. The use of tap water was premised on the fact that, water meant for concrete and construction works must be free from harmful chemicals (salts and oil) and impurities (suspended particles). The plastic sheet used for the curing purposes was purchased from suppliers in the commercial market in Kumasi. The specimens were covered with plastic (polyethylene) sheets in two layers to retain moisture in the concrete specimens. Jute sack materials were obtained from the commercial market in Kumasi, Ghana. The jute sacks were used to cover the concrete specimens and kept wet during the curing period.

### Preparation of concrete specimens

The concrete was prepared in the controlled laboratory setting. A laboratory pan mixer was used for the mixing of the concrete. A concrete grade of M20 with the targeted compressive strength of 20 N/mm<sup>2</sup> was used for the study. The mix proportion adopted for the experiment was a ratio of 1:1.5:3 with 0.6 water-cement ratio. The concrete beams and cubes were produced following BS EN 12390-1 (2012) and BS EN 12390-2 (2019) respectively. Steel mould of size 100 × 100 × 100 mm was used for casting concrete cubes and 100 × 100 × 500 mm for casting beams. A total of 180 specimens (120 cubes & 60 beams) were prepared for experiment. The curing was following BS EN 12390-2 (2019). After an overnight setting of the, the concrete specimens (cubes and beams) were de-moulded and were labelled for easy identification. The specimens were subjected to 7, 14, 21, 28 and 56 days of curing before testing. Four different curing methods were adopted for the curing of the specimens. The methods were immersion (ponding), plastic (polyethylene) sheet covering, Jute (hessian) sack covering, and sprinkling.

### *Immersion curing*

The specimens were put in water in a curing tank in the laboratory (see Figure 1a). The water for curing was tested every 7 days and the temperature of water was on





respectively for 28 and 56 days of curing. The low strength obtained for the sprinkling method of curing can be attributed to high moisture movement and evaporation in the concrete specimens as the specimens are uncovered and unprotected against early drying out of the concrete (Rahman et al., 2012).

The finding corroborates the assertion that concrete curing age has an influence on strength (James et al., 2011). The result therefore confirms the claim that appropriate curing method is critical and necessary for all concrete structures. For the targeted concrete grade of M20, it was expected that on the 28-day of curing the compressive strength should attain strength value of 20 N/mm<sup>2</sup>. It can be observed from Table 1 that all curing methods attained more than the of 20 N/mm<sup>2</sup>, except the sprinkling method (19.80 N/mm<sup>2</sup>) which was even closed to the targeted strength. The immersion method recorded an average compressive strength of 23.43 N/mm<sup>2</sup> as compared to the sprinkling method of 19.80 N/mm<sup>2</sup> which translates to about 16% increase of the immersion method over the sprinkling method. This therefore implies that the appropriate curing method use for curing concrete can have a significant effect on the compressive strength of the concrete, especially in the controlled environment for precast and laboratory-based concrete units.

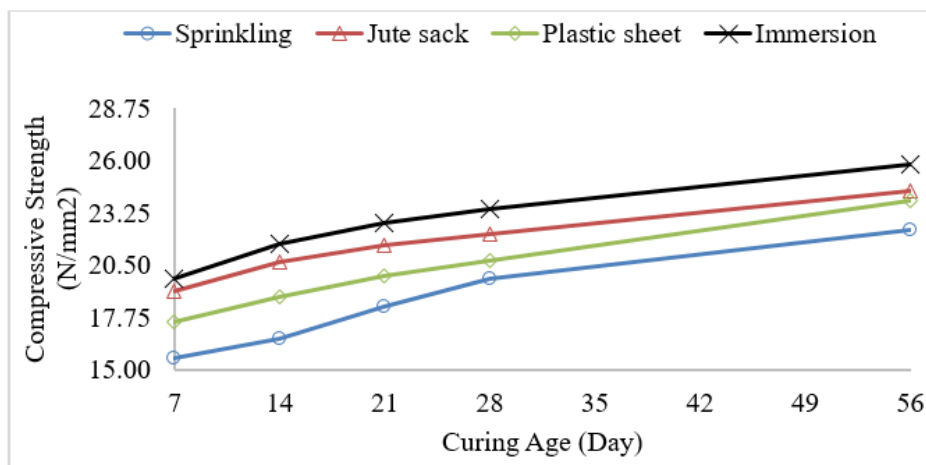

Figure 3: Compressive strength of concrete cube specimens

Table 1: Average test results

Curing day	Compressive strength (N/mm <sup>2</sup> )				Flexural strength (N/mm <sup>2</sup> )			
	Sprinkling	Plastic sheet	Jute sack	Immersion	Sprinkling	Plastic sheet	Jute sack	Immersion
7	15.63	17.53	19.10	19.80	1.82	2.02	2.15	2.44
14	16.63	18.80	20.68	21.60	2.01	2.12	2.22	2.54
21	18.33	19.97	21.57	22.70	2.24	2.31	2.43	2.65
28	19.80	20.74	22.10	23.43	2.40	2.50	2.61	2.81
56	22.33	23.90	24.43	25.83	3.01	3.16	3.39	3.49

### Flexural strength of concrete beams

The result of the flexural strength test of the concrete specimens are shown in Figure 4. The flexural strength result followed the pattern of the compressive strength result. As was also expected, the flexural strength of the concrete



specimens increased with increase age of curing. This result is consistent with Elinwa and Kabir (2019) findings that flexural strength of concrete increased as the curing age increased. It can be observed that the specimens cured by immersion method recorded the highest flexural strength for all the curing days with strength values of 2.81 and 3.49 N/mm<sup>2</sup>, respectively on 28 and 56 days of curing. Nahata et al. (2014) attributes the high strength to low water loss from the concrete specimens during curing. Wet jute sack covering method followed with average values of 2.61 and 3.39 N/mm<sup>2</sup>, respectively on 28 and 56 days of curing. The specimens cured by sprinkling method recorded the lowest flexural strength values of 2.4 and 3.01 N/mm<sup>2</sup> on the 28th and 56th days of curing respectively. In general, it was observed that there was increase in flexural strength with respect to curing age. This is similar to what Neville (1996) reported that flexural test results may be influenced by the specimen's preparation and size; moisture conditions, curing; and the type and volume of coarse aggregates used for specimen preparation.

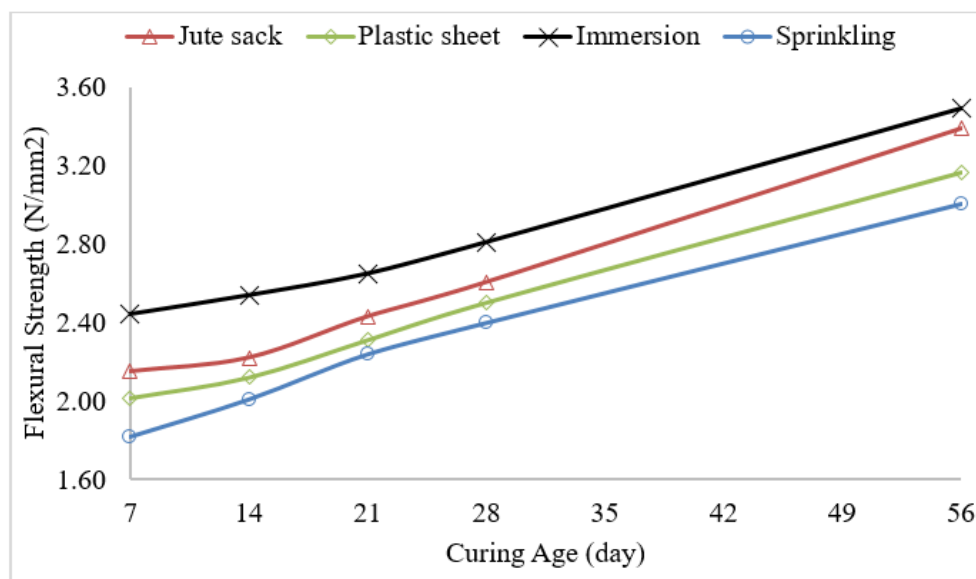

Figure 4: Average flexural strength of concrete beam specimens

## CONCLUSION

The study investigated the effect of curing methods on the strength properties of concrete in the hot humid climate, particularly in the hot humid climate for precast and laboratory-based concrete units. The study found that the immersion method of curing obtained the highest compressive and flexural strength of the concrete specimens with about 16 strength improvement. The study, therefore, concludes that the use of appropriate method of curing can have an effect on the compressive and flexural strengths of the concrete, and therefore recommend the adoption of immersion curing method to concrete producers, especially in the hot humid climate for precast and laboratory-based concrete units 'production. This study only focused on the strength properties of concrete cured under different methods, and therefore recommend further studies to investigate the effect of curing methods on the physical and durability properties of concrete produced in the hot humid climate.

## REFERENCES

- Boakye, D. M, Uzoegbo, H. C, Mojagotlhe, N., & Malemona, M. (2014). Effect of different curing methods on the compressive strength development of pulverized copper slag concrete. *Journal Materials and Engineering Structures*, 1(1), 11–21, <http://oaji.net/articles/2014/980-1403726549.pdf>
- BS EN 197-1 (2011). *Cement Composition, Specifications and Conformity Criteria for Common Cements*. British Standard Institution. London.
- BS EN 12390-2 (2019). *Testing Hardened Concrete. Making and Curing Specimens for Strength Tests*. British Standard Institution. London.
- BS EN 12390-1 (2012) *British Standard for Testing Hardened Concrete-Part 1 Shape, Dimensions and Other Requirements for Specimens and Moulds*. British Standard Institution. London.
- BS EN 12390-3 (2019). *Testing hardened concrete – Part 3: Compressive strength of test specimens*. British Standard Institution. London.
- BS EN 12390-5 (2019). *Testing hardened concrete – Part 5: Flexural strength of test specimens*. British Standard Institution. London.
- Danso, H., & Boadi, J. K. (2019). Replacement of Sand with Bauxite Mining Waste in Concrete Production. *Journal of materials and Engineering Structures*, 6(4), 525–534, <http://revue.ummt0.dz/index.php/JMES/article/view/2052/pdf>
- Elinwa, A., & Kabir, N. (2019). Flexural Strength and Compressive Strength Relations of Hospital Waste Ash Concrete. *SSRN Electronic Journal*. DOI: 10.2139/ssrn.3309506.
- Federowicz, K., Kaszyńska, M., Zieliński, A., & Hoffmann, M. (2020). Effect of Curing Methods on Shrinkage Development in 3D-Printed Concrete. *Materials*, 13, 2590. <https://doi.org/10.3390/ma13112590>.
- James, T. A., Malachi, A., Gadzama, E. W., & Anametemfioka, V. (2011). Effect of Curing Methods on the Compressive Strength of Concrete. *Nigerian Journal of Technology*, 30(3), 14-20.
- Liu, B., Jiang, J., Shen, S., Zhou, F., Shi, J., & He, Z. (2020). Effects of curing methods of concrete after steam curing on mechanical strength and permeability. *Construction and Building Materials*, 256, 1-10, <https://doi.org/10.1016/j.conbuildmat.2020.119441>.
- Mamlouk, M. S., & Zaniewski, J. P. (2006). *Materials for civil and construction engineers*, (2nd ed.). New Jersey: Pearson Prentice.
- Nahata, Y., Kholiab, N., & Tank, T. G. (2014). Effect of Curing Methods on Efficiency of Curing of Cement Mortar. *APCBEE Procedia*, 9 (2014) 222 – 229.
- Neville, A. M (2002). *Concrete technology*. England: Pearson Education Limited. p.438.
- Neville, A. M. (1996). *Properties of concrete* (4th Ed.). Edinburg Gate, Harlow, England: Addison Wesley Longman Limited, Pearson Education Ltd.
- Nurrudin M. F., Haruna S., Mohammed B. S., & Sha'aban, I. G. (2018). Methods of curing geopolymer concrete: A review. *International Journal of Advanced and Applied Sciences*, 5(1), 31-36.
- Olanitori, L. M. (2006). Mitigating the effect of clay content of sand on concrete strength. 31st Conference on Our World in Concrete and Structures. Singapore: CI-Premier PTE LTD. Retrieved from: <http://www.cipremier.com/100031035>.



- Raheem, A. A., & Abimbola, S. A. A. (2006). Effect of Specimen Size on the Compressive Strength of Concrete. *USEP. Journal of Research Information in Civil Engineering (RICE)*, 3(1), 55-64.
- Raheem, A. R., Soyngbe, A. A., & Emenike, A. J. (2013). Effect of Curing Methods on Density and Compressive Strength of Concrete. *International Journal of Applied Science and Technology*, 3(4), 55-63.
- Rahman, M. S., Islam, S. M., & Abedin, M. Z. (2012). Effect of Curing Methods on Compressive Strength of Concrete. *Bangladesh Journal of Agricultural Research* 23(1&2):71-76.
- Rao, M. V., Krishna, P., Rathish Kumar, K., & Azhar, M. (2010). A study on the influence of curing on the strength of a standard grade concrete mix. *Facta Universitatis Series: Architecture and Civil Engineering*, 8(1), 23-34.
- Surahyo, A. (2019). *Concrete Construction: Practical Problems and Solutions (1st Ed.)*. Springer Nature Switzerland AG. ISBN-13: 978-3030105099.
- Usman, N., & Nura Isa, M. (2015). Curing Methods and Their Effects on The Strength of Concrete. *Journal of Engineering Research and Applications*, 5(7), 2248-2269.
- Wojcik, G. S., & Fitzgarrald, D. R. (2001). Energy Balances of Curing Concrete Bridge Decks. *Journal of Applied Meteorology*, 40(11), 2003–2025.
- Zain, M. F. Safiuddin, M. M., & Yusof, K. M. (2000). Influence of Different Curing Conditions on the Strength and Durability of High-Performance Concrete. In the Proceedings of the Fourth ACI International Conference on Repair, Rehabilitation Maintenance. Seoul, South Korea.





# KEY FACTORS FOR ELECTRONIC PROCUREMENT SYSTEMS IN THE PROMOTION OF SUSTAINABLE PROCUREMENT IN CONSTRUCTION PROJECTS

Sitsofe Kwame Yevu<sup>1</sup>, Ann Tit Wan Yu<sup>2</sup>, Amos Darko<sup>3</sup> and Mershack Opoku Tetteh<sup>4</sup>

<sup>1,2,3,4</sup>*Department of Building and Real Estate, The Hong Kong Polytechnic University, Kowloon, Hong Kong SAR*

The current drive for digitalization in the construction industry has increased the attention on various construction processes including construction procurement. To improve efficiency in construction procurement, electronic procurement systems (EPS) were introduced to automate the process. However, there are global concerns for construction industry's contribution to sustainability. Hence, the interest for digital transformations to focus on sustainability underscores the use of sustainable procurement initiatives in construction procurement. Although, EPS have gained some attention in literature, their relationship with the dimensions of sustainability are limited in extant literature. Therefore, the aim of this study is to identify EPS relationships with the initiatives of sustainable procurement in the construction industry. Specifically, the key issues needed to enhance EPS contribution to sustainable procurement are highlighted. A systematic literature review was conducted using a three-stage process to examine previous studies. The findings revealed that EPS mostly contributes to economic cost sustainability. Environmental and social sustainability issues need to be improved with the use of EPS. Especially, the contribution of EPS towards to green criteria and local inclusiveness have to be strengthened. Future research directions were provided to address the knowledge gaps identified in literature. This study provides researchers and practitioners with knowledge on EPS areas that needs to be strengthened to enhance the promotion of sustainable procurement initiatives in construction procurement.

Keywords: construction industry, construction procurement, electronic procurement, sustainable procurement

## INTRODUCTION

The construction industry has long been criticized for decreased levels of efficiency and effectiveness in its activities (Adriaanse et al., 2010; Lines et al., 2017). More importantly, the impact of construction processes on the environment, society and

<sup>1</sup> sitsofe-k.yevu@connect.polyu.hk

<sup>2</sup> bsannyu@polyu.edu.hk

<sup>3</sup> amos.darko@connect.polyu.hk

<sup>4</sup> mershack-opoku.tetteh@connect.polyu.hk

economic activities calls for the construction industry to improve sustainability urgently (Roman, 2017; Ikram et al., 2020). This need motivated the construction industry to adopt innovative technologies such as electronic procurement systems (EPS) in construction procurement processes as internet technology emerged (Grilo and Jardim-Goncalves, 2011). Considering that construction procurement has been the crucial avenue for obtaining construction-related products and services, it has also been challenged to contribute to sustainability via initiatives concentrating on environmental, social, and economic aspects (Brammer and Walker, 2011). In effect, sustainable procurement (SP), which focuses on infusing initiatives, specifications and criteria into construction procurement to make it more compatible with sustainability goals, were introduced (Ramkumar and Jenamani, 2015).

With digitization advancing a global revolution in the construction industry, EPS present a promising future for digitalizing construction procurement to increase efficiency and to facilitate sustainability (Yevu and Yu, 2019). However, research on EPS has had less focus on how EPS relate to sustainability initiatives. This is important because as EPS matures to become the normal practice for construction procurement, project organizations would still be faced with the reality that sustainability is longer a matter of choice – but reality (Roman, 2017). This raises questions concerning the contributions of EPS toward sustainable development through the initiatives of SP. Though limited attempts have been made in literature to address this issue by few studies (Walker and Brammer, 2012, Ramkumar and Jenamani, 2015), till date, there is no comprehensive review of extant literature to examine the scope of EPS connections to SP initiatives. Hence, this study aims to explore the contributions of EPS to SP initiatives via a systematic review of existing literature. This would promote scholarly debate on holistic evaluation of EPS usage in construction procurement. For researchers and practitioners, this study highlights the areas of sustainability that could be improved with the use of EPS in construction projects.

## LITERATURE REVIEW

The literature review section provides the research developments regarding EPS and SP in the construction industry. Further, procurement from the perspective of the building lifecycle is discussed in this section.

### **Electronic procurement systems**

Since the turn of the twentieth first century, EPS have gained attention due to the benefits it brings to construction procurement (Yevu et al., 2021). Benefits associated with the improvements of efficiency and effectiveness were the main motivators of EPS adoption. EPS refer to the use of web-based systems or online platforms to digitize and automate the manual paper-based procurement process for construction projects (Mehrbod and Grilo, 2018). Since construction procurement has many processes, EPS comprise of several tools that conduct various functions of the procurement processes at any stage in the project (Ibem and Laryea, 2015). For instance, the e-tendering/e-bidding tool conducts the tendering/bidding functions at the pre-contract stage of projects. Hence, based on the functions desired by the project or client, several EPS tools can be combined on a project. Other EPS tools, such as project payment monitoring tools, could be combined with the e-tendering tool based on the procurement functions required.

Integration of other technologies with EPS have been explored in literature. While Grilo and Jardim-Goncalves (2011) challenged the reluctant effort of integrating EPS and building information modelling (BIM) in construction research, it highlights the potential for holistic digitization of design and procurement activities. Also, infusing cloud computing into EPS operations by Costa and Tavares (2013) offers ameliorating avenues to improve EPS operations in a digitized built environment. In advocating the use of EPS in construction procurement, the need for sustainability has not attracted much interest in construction research.

### **Sustainable procurement (SP)**

Generally, SP refers to procurement and supply chain practices that emphasize on sustainability to achieve sustainable outcomes (Ruparathna and Hewage, 2015). More specifically, SP is described as infusing technologies, specifications and criteria into procurement for environmental protection, societal progress and economic development through initiatives such as resource efficiency, improved quality of products and services and cost optimisation on whole life basis (McMurray et al., 2014; Grandia, 2016). Therefore, SP allows organizations to obtain materials, products and construction works with value addition not only to the project organization, but also to the environment and society. Accordingly, Yu et al. (2020) indicated that various governments had made efforts to promote SP initiatives through construction procurement in order to enhance sustainable developments. Considering the social dimension of SP, EPSs provide transparency and collaboration opportunities which are needed to facilitate social sustainability initiatives such as networking, social capital leverage and local supplier inclusiveness. Also, transparency enhances new supplier identification in procurement networks. While the environmental dimension of SP focuses on conservation or efficient use of resources throughout the lifecycle of projects, the economic dimension of SP places emphasis on improving the time and cost involved in projects. However, in promoting SP, the use of EPS which would become the main avenue for procurement in the future of construction, has not garnered research attention. This creates a limitation for advancing sustainability in construction procurement processes.

### **Lifecycle assessment with SP**

A core element of SP is to focus on the lifecycle perspective. Through this, resources selected for projects are assessed considering their implications on the environment from project the planning stage to the end-of-life of the project (Walker and Brammer, 2012). Lifecycle assessment is the systematic evaluation of the environmental impacts of resources/products through all stages of building lifecycle including material production, on-site construction, operation, maintenance and final demolition and disposal (Luo et al., 2019). Hence, SP recommends processes/products that have less impact on the environment to be used in construction of projects. The promotion of a paperless environment with the use of EPS provides a suitable platform to catalogue construction materials for specifications regarding lifecycle assessments in projects. Undoubtedly, EPS offer future construction the ability to execute sustainable buildings.

## RESEARCH METHODOLOGY

This study adopts the systematic literature review method to examine research articles in a three-stage process, as adopted in similar review studies such as Hong et al. (2012) and Yu et al. (2020). Systematic literature reviews facilitate the identification and evaluation of existing literature for value addition in the development of knowledge (Seuring and Müller, 2008; Yevu et al., 2020). Broadly, the activities of the three-stage process involve database selection, screening and selection of articles and examination of articles and examination of articles. Fig. 1 presents the review process in this study.

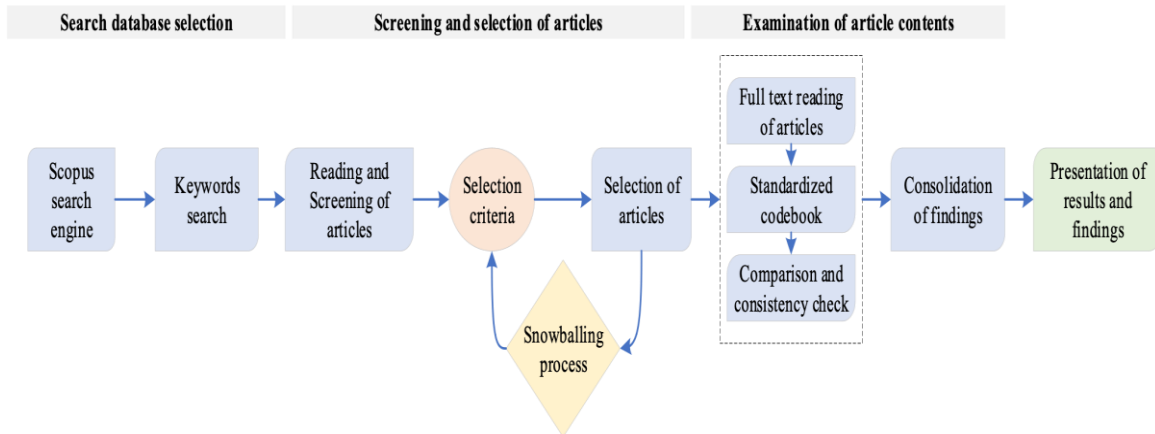

Fig. 1 Review process for the study

### Selection of search database for articles

For the selection of publications on EPS and SP in the construction industry, an effective search engine – Scopus, was adopted. Scopus provides a wider scope of coverage for construction publications and has a greater level of precision in capturing current publications as compared to other databases such as PubMed and Web of Science (Falagas, 2008). In conducting the search, keywords were used the title/abstract/keywords section of Scopus. These keywords focused on phrases or terms commonly used to represent EPS and sustainability in procurement. The string of keywords employed for the search are – "Electronic procurement" OR "E-procurement" OR "Digital procurement" OR "E-tendering" OR "E-bidding" AND "Sustainable procurement" OR "Green procurement" OR "sustainability" OR "Environment" OR "Economic" OR "Social" AND "Construction" OR "Built environment". The search filter was set with limitations to English and journal articles. However, there was no limitation on the year range. The initial search resulted in 28 articles. In addition, a snowballing technique was adopted by searching through the references of these selected articles to identify other relevant articles for this study using a selection criteria (Yu et al., 2020; Govindan and Bouzon, 2018).

### Screening and selection of articles

In selecting the most relevant publications, a careful screening of the abstracts of these publications was conducted. During the screening process, the selection criteria was publications that focused on EPS connections with sustainability. Publications that did not focus on EPS connections to sustainability or SP were excluded. Consequently, 17 articles were selected after the initial screening. As

previously stated, the snowballing technique that was used to screen the references of selected articles led to the identification of five additional articles. In total, 22 relevant articles were selected for through and detailed examination. Details of the journal sources and the number of publications for each journal is presented in Table 1. Since this research area is in its infantile stages, the number of articles retrieved were considered suitable as it compares favourably with literature reviews in established research areas (e.g. Osei-Kyei and Chan, 2015).

**Table 1. Journals with relevant articles**

No.	Journals	Number of articles
1	Journal of Cleaner Production	2
2	Journal of Information Technology in Construction	4
3	Quality Innovation Prosperity	1
4	Built Environment Project and Asset Management	1
5	Engineering, Construction and Architectural Management	1
6	International Journal of Procurement Management	1
7	International Journal of Managing Projects in Business	1
8	KSCE Journal of Civil Engineering	1
9	Automation in Construction	1
10	Computers in Industry	1
11	Journal of Financial Management of Property and Construction	1
12	International Journal of Economics and Management Engineering	1
13	Government Information Quarterly	1
14	Journal of Construction Research	1
15	IEEE Systems Journal	1
16	International Journal of Production Economics	1
17	International Journal of Construction Management	1
18	International Journal of Operations and Production Management	1

### Examination of article contents

A careful reading of the full contents of article was conducted by the authors independently at this stage. The research articles were carefully examined by structuring the contents of the articles into a standardized codebook. This allowed the authors to identify and categorize the relevant topics discussed regarding EPS connections to sustainability and SP. The use of multiple authors and a standardized codebook facilitated consistency checks with the categorization of EPS contributions to SP initiatives (i.e. environmental, social and economic). Furthermore, the standardized codebook contained the descriptive analysis of the articles selected (publication year, authors, countries and the respective journals). Aside the descriptive analysis, the structural categories for analysis were based on the dimensions of sustainability derived from EPS contributions. Since this search is exploratory in nature, the inductive approach was adopted for the identification of sub-categories regarding the dimensions of sustainability in the standardized codebook. In doing this, the authors were able to compare the sub-categories derived from the full content readings, which allowed the sub-categories to reflect core initiatives of sustainability in construction (Yu et al., 2020). Consequently, the authors consolidated their findings, respectively. From the consolidation exercise,

the connections between EPS and sustainability were mapped and visualized. The analysis and results are discussed in the subsequent sections.

## RESULTS AND DISCUSSIONS

To provide insights into the research developments for aspects of EPS in terms of SP and sustainability initiatives, the findings from the analysis are presented as follows; publication trend, descriptive and structural categories results and future research directions.

### Annual publication trend

Fig. 2 shows that research interest in EPS in relation to sustainability began in 2003 and has been fairly stable a decade afterwards. Possible explanation for this occurrence could be the emergence of internet technology in construction processes which led to the introduction of EPS. Hence, highlighting EPS in relation sustainability initiatives was not the main focus. However, the spike in 2015 and ascension in publication from 2019 provides an indication of research interest in exploring the sustainability aspects of EPS in recent years. Partly, this phenomenon could be attributed to active renewal of including sustainability in procurement (Lupova-Henry and Dotti, 2019).

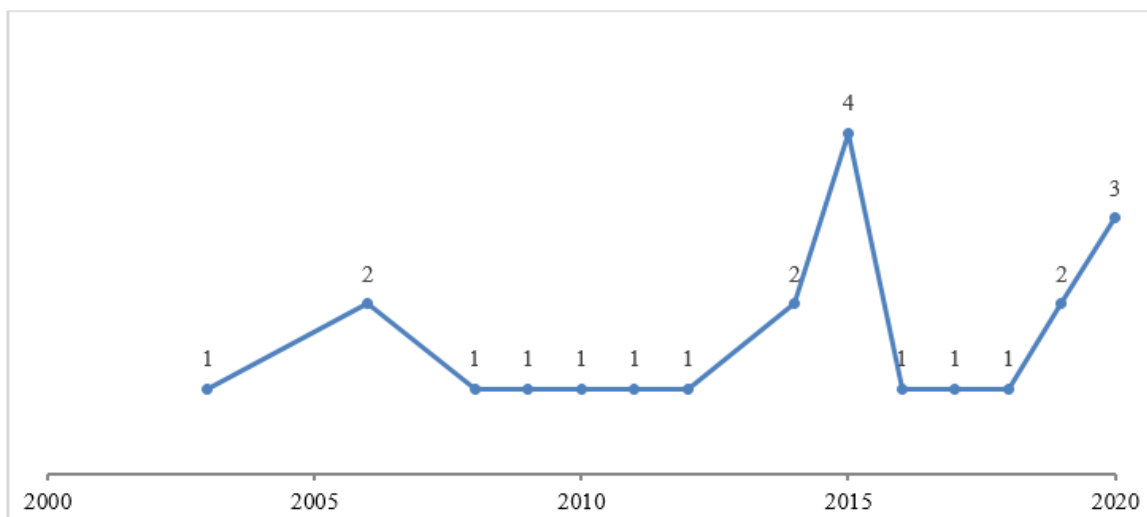

Fig. 2. Annual publication trend

### Descriptive and structural categories

Since, SP endeavors to promote the three main dimensions of sustainability by focusing on environmental protection, social progress and economic development with procurement, it has been associated with initiatives and specifications such as resource efficiency, optimization of cost, quality of products, job creation (Roman, 2017; Walker and Brammer, 2012). Therefore, in this study, the functionalities/benefits of EPS in relation to sustainability were assessed in three main structural categories, i.e. economic, environmental and social contributions. Sub-categories were deduced for the main structural categories – cost optimization, time reduction, productivity, resource efficiency, green criteria, transparency and trust and local inclusiveness. Table 2 presents the connections EPS with the initiatives of sustainability in research.



**Table 2. EPS connection to SP initiatives in literature**

Ref. <sup>1</sup>	Sustainable procurement initiatives							Country <sup>2</sup>
	Economic		Environmental			Social		
	Cost optimization	Time reduction	Productivity	Resource efficiency	Green criteria	Transparency and Trust	Local inclusiveness	
R1	✓	✓	✓	✓		✓	✓	Hong Kong
R2	✓	✓	✓					Nigeria
R3	✓					✓		Slovakia
R4	✓	✓		✓		✓		Saudia Arabia
R5	✓	✓	✓	✓		✓		Hong Kong
R6	✓	✓		✓				Australia
R7						✓		UK
R8	✓							Korea
R9						✓	✓	Portugal
R10	✓	✓	✓			✓		Columbia and Spain
R11	✓	✓	✓			✓		UK
R12	✓	✓						Iran
R13	✓		✓					UK
R14			✓			✓		Italy, UK, Australia
R15	✓			✓				Australia
R16	✓	✓						UK
R17	✓	✓	✓			✓		USA
R18	✓	✓		✓		✓		India
R19	✓			✓	✓			UK
R20					✓			Canada
R21	✓	✓	✓					South Africa
R22	✓							UK

Note: R1= Yu et al. (2020); R2= Ibem et al. (2020); R3= Delina et al. (2020); R4= Sayed et al. (2019); R5= Yevu and Yu (2019); R6= Al-Yahya et al. (2018); R7= Naoum and Egbu (2016); R8= Eom et al. (2015); R9= Costa and Tavares (2014); R10= Tarazona-Bermudez et al. (2014); R11= Eadie et al. (2011); R12= Farzin and Nezhad (2010); R13= Lou and Alshawi (2009); R14= Hardy and Williams (2008); R15= Betts et al. (2006); R16= Wong and Sloan (2006); R17= Issa et al. (2003); R18= Ramkumar and Jenamani (2015); R19= Walker and Brammer (2012); R20= Ruparathna and Hewage (2015); R21= Ibem and Laryea (2017); R22= Meehan and Bryde (2015).

<sup>2</sup>Referring to Country of study.

### EPS economic connections to SP initiatives

Considering that construction industries around world contribute more than 10% to national economies and play a vital role in national economic developments, cost associated with procurement is essential (Santoso and Bourpanus, 2019). To that end, EPS have been applied to target economic elements such as cost and

time value for money. It is worth mentioning that majority of the studies identified economic contributions of EPS to sustainability.

In terms of cost optimization, which is the most identified sub-category (Table 2), past studies highlighted the influence of EPS in promoting a cost-effective procurement process, which in turn, impacts the cost of projects. For instance, Eadie et al. (2011) and Ibem et al. (2020) indicated low transaction cost in the procurement process with EPS adoption on projects. Further, cost savings in the management of procurement processes were noted by several studies (Lou and Alshawi, 2009; Al-Yahya et al., 2018; Farzin and Nezhad, 2010). Other contributions of EPS to economic sustainability lies in cost-effectiveness by facilitating negotiations with suppliers (Delina et al., 2020). For economic cost sustainability, EPS have potentials of enhancing online payments and reducing the cost accrued in the procurement processes (Meehan and Bryde, 2015). Generally, issues surrounding project cost attracts much attention in the construction industry. Therefore, it is not surprising that cost optimization has been the focus of EPS. Although, these studies identified the cost benefits of EPS, they did not explicitly associate such benefits to the economic sustainability paradigm in literature.

For time reduction, Ibem and Laryea, 2017 and Sayed et al. (2019) showed the increased transaction speed effect of EPS adoption in procurement processes for projects. Such speed is needed to avoid unnecessary delays that usually beset the manual paper-based process. Consequently, many studies focused their attention on the ability of EPS to reduce the cycle times of procurement processes as shown in Table 2 (Issa et al., 2003; Yevu and Yu, 2019). Typically, construction procurement has many stakeholders exchanging procurement related information, hence, the faster flow of information and data among such stakeholders improves decision-making in the procurement cycle duration for project activities. While existing literature acknowledges the reduction of time towards efficient use of project resources, more quantifiable evidence are needed to guide their contributions towards sustainability.

The productivity improvements EPS bring lie with competitiveness, quality improvement, error reduction and document management (Hardy and Williams, 2008; Ibem and Laryea, 2017). In addition, EPS enhance better coordination and management of procurement activities and suppliers while ensuring accuracy in procurement activities (Issa et al., 2003; Tarazona-Bermudez et al., (2014). Through these productivity improvements while using EPS, construction procurement is equipped to foster economic sustainability in the construction industry. However, existing literature on productivity improvements, specifically construction procurement, do not actively recognize the incremental benefit that productivity improvement bring to economic sustainability. Hence, there is a lack of research on how productivity improvement translates to sustainability.

### **EPS environmental connections to SP initiatives**

As environmental concerns increase regarding construction activities, improving practices that are environmentally friendly have gained the spotlight in construction procurement, since it is a vital artery in the selection of material, practices and services for project delivery. Although EPS have been touted as an environmentally sustainable way in construction procurement, previous studies

mostly focused on aspects of resource efficiency while the use of EPS in promoting green criteria has been under-studied in extant literature (see Table 2).

The promotion of paperless environment by reducing the volume of paper documentations used in procurement activities has been frequently identified as enhancing resource efficiency in literature. For example, by reducing paper documents for tendering, EPS promote environmentally friendly practices in efforts to enhance procurement practices (Ruparathna and Hewage, 2015; Ramkumar and Jenamani, 2015). In addition, EPS reduces excess transportation energies expended in conducting procurement activities (Yevu and Yu, 2019). Other studies identified the potential of EPS in resource efficiency via promoting waste reduction and recycling (Walker and Brammer, 2012; Yu et al., 2020). Though EPS facilitate a paperless environment, their use for assessment of specifications for recycle is limited in literature. This provides fertile avenues to enhance the use EPS in construction product specifications.

On the contrary, the use of EPS in facilitating green criteria has not gained much attention in existing literature. However, this identification provides an avenue for using EPS to apply green criteria and specifications. In support of this, Walker and Brammer (2012) indicated that EPS help with specifying suppliers' environmental practices, labour, health and safety requirements. In fact, EPS could help facilitate green procurement specifications and requirements checks for products and materials from relevant authorities. Further, EPS aids in improving environmental practices as suggested by Ruparathna and Hewage (2015). While the infantile literature shows the potential of EPS in applying green criteria, more research is needed to consolidate the ways in which EPS can be used effectively in evaluating green specifications in procurement.

### **EPS social connections to SP initiatives**

Social requirements for construction procurement affect procurement processes and have implications on project organizations (Montalbán-Domingo et al., 2019). Hence, the provision of social initiatives in procurement must be situated in a relational approach to sustain communities and improve livelihoods (Roman, 2017). While the sub-category – transparency and trust, has gained considerable interest from existing EPS literature, elements associated with local inclusiveness has been neglected (see Table 2).

Building transparency and trust in procurement processes is key for achieving the confidence of many stakeholders in a project for sustainable developments. In effect, EPS ability to improve transparency in procurement processes and activities culminates in attaining public trust and equity from multiple stakeholders at the project and community levels. For instance, since EPS provides online monitoring applications, other external stakeholders can track the progress of projects, thereby, making the procurement process, visible, transparent and accountable (Hardy and Williams, 2008; Naoum and Egbu, 2016; Eadie et al., 2011). Transparency and trust have been highlighted as contentious issues in existing studies, hence this study highlights EPS features that ensure transparency in procurement which is a critical element of facilitating sustainability.

For local inclusiveness, Walker and Brammer (2012) indicated that more efforts are needed to improve EPS contributions to SP initiative. Perhaps, this could be the

explanation for the limited attention to this sub-category. Notwithstanding, Costa and Tavares (2014) and Yu et al. (2020) pointed out the potential of EPS for local supplier involvement and collaboration. This is exemplified in the study of Costa and Tavares (2014) by growing EPS social networks for suppliers to encourage collaboration and local job creation. Fig. 3 presents a summary of relationships regarding EPS and sustainability initiatives. This finding presents new ways to engage EPS in promoting social sustainability which has not been much addressed in existing studies.

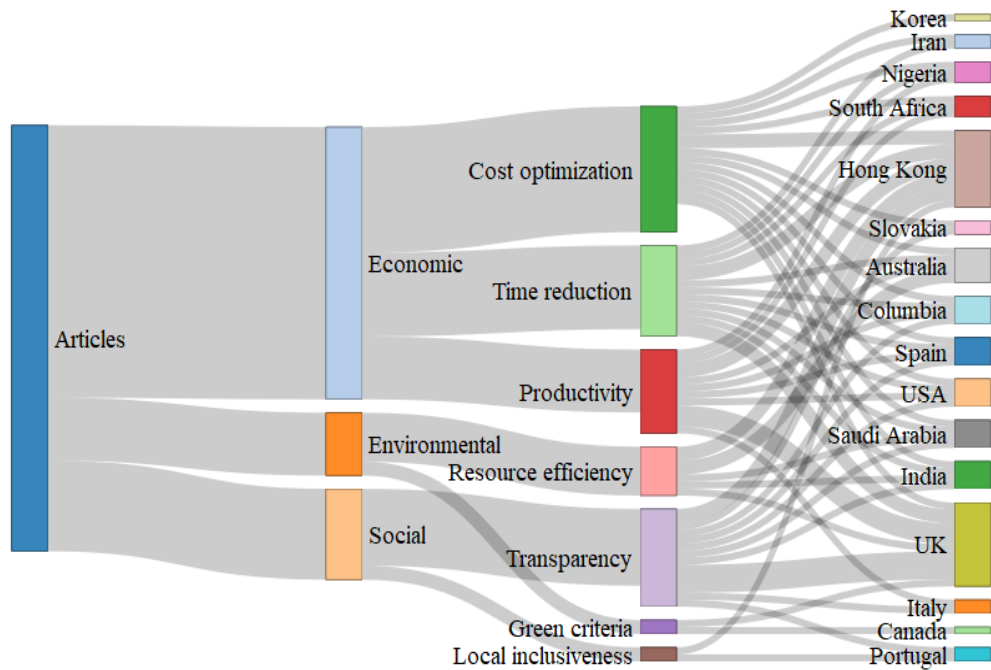

Fig. 3 Summary of relationships regarding EPS and sustainability initiatives.

## FUTURE RESEARCH DIRECTIONS

Although EPS economic cost sustainability has gained prominence in literature, the evidence is sparsely coupled with SP initiatives in the construction industry. Future research should target comprehensive evaluations of the benefits/functions of EPS towards SP initiatives on cost efficiency.

For environmental initiatives, future research could focus on: (1) quantitative models that assess the gains of less paperwork with the use of EPS. This is essential in the provision of evidence for EPS contribution to environmental protection initiatives, which is lacking in EPS literature; and (2) developing technology or management systems/frameworks that accelerate the application and checking of green criteria and specification of contractors and suppliers. In doing this, integrated platforms for checking green certification of construction products and materials would be enhanced. Also, through EPS integration with databases such as cloud computing, contractors/suppliers environmental performance could be verified before projects are awarded. This ensures compliance with green specification and requirements, e.g. low carbon initiatives.

Concerning social initiative, futures studies should pay more attention to how local inclusiveness could be incorporated into EPS functions, as EPS needs more strengthening in this aspect of sustainability. Measures such as developing a platform that promotes small and medium sized organizations at local communities via supportive supplier frameworks could be used in EPS enhance inclusiveness.

## **CONCLUSIONS**

Recent developments to make the construction industry more sustainable with digitization, brings the spotlight on EPS in construction procurement. Although, EPS have been identified with many gains to construction procurement, there is scarce literature indicating their sustainability potential. Specifically, there is a lack of literature that underscores the contributions of EPS to SP initiatives. This study aimed to review the contributions of EPS to the economic, environmental and social dimensions of SP. In a three-stage search process, adopting Scopus search dataset, relevant research articles were carefully selected and critically examined. The results show an embryonic stage of development with EPS contribution to SP research in the publication trend. The findings show that while the economic cost sustainability contributions of EPS have gained traction in literature, the environmental and social contributions are considerably evolving with social contributions being the least researched aspect of EPS. Based on these findings, future research avenues are provided to aid in the development of theory and practice by improving EPS functions in terms of environmental practices and social inclusiveness. This study provides valuable insights for researchers and practitioners to shift attention to other environmental and social aspects that has the potential to aid EPS contribute to goals of sustainability. Nonetheless, compared to the relatively small sample of studies in this study, researchers could increase the number of studies in future research as the knowledge domain matures.

## **ACKNOWLEDGEMENT**

The study forms part of a PhD research project on adoption of electronic procurement systems in the construction industry, which shares similar background and methodology with other papers but with different objectives and scopes. The authors thank the Department of Building and Real Estate of The Hong Kong Polytechnic University for funding this research.

## **REFERENCES**

- Adriaanse, A., Voordijk, H., & Dewulf, G. (2010). Adoption and use of interorganizational ICT in a construction project. *Journal of Construction Engineering and Management*, 136(9), 1003-1014.
- Al-Yahya, M., Skitmore, M., Bridge, A., Nepal, M. P., & Cattell, D. (2018). E-tendering readiness in construction: an a priori model. *International Journal of Procurement Management*, 11(5), 608-638.

- Betts, M., Black, P., Christensen, S., Dawson, E., Du, R., Duncan, B., & Gonzalez Nieto, J. (2006). Towards secure and legal e-tendering. *Journal of Information Technology in Construction*, 11(e-Commerce in Construction), 89-102.
- Brammer, S., & Walker, H. (2011). Sustainable procurement in the public sector: an international comparative study. *International Journal of Operations and Production Management*, 31(4), 452-476.
- Costa, A. A., & Tavares, L. V. (2013). Advanced multicriteria models to promote quality and reputation in public construction e-marketplaces. *Automation in Construction*, 30, 205-215
- Costa, A. A., & Tavares, L. V. (2014). Social e-business as support for construction e-procurement: e-procurement network dynamics. *Automation in Construction*, (43), 180-186.
- Delina, R., Michňová, M., Húska, P., & Spišák, J. (2020). The Role of Supplier Quality in e-Procurement Negotiation. *Quality Innovation Prosperity*, 24(1), 29-39.
- Eadie, R., Perera, S., & Heaney, G. (2011). Key process area mapping in the production of an e-capability maturity model for UK construction organisations. *Journal of Financial Management of Property and Construction*, 16(3), 197-210.
- Eom, S. J., Kim, S. C., & Jang, W. S. (2015). Paradigm shift in main contractor-subcontractor partnerships with an e-procurement framework. *KSCE Journal of Civil Engineering*, 19(7), 1951-1961.
- Falagas, M. E., Pitsouni, E. I., Malietzis, G. A., & Pappas, G. (2008). Comparison of PubMed, Scopus, web of science, and Google scholar: Strengths and weaknesses, *FASEB Journal*, 22(2), 338-342.
- Farzin, S., & Nezhad, H. T. (2010). E-procurement, the golden key to optimizing the supply chains system. *International Journal of Economics and Management Engineering*, 4(6), 837-843.
- Govindan, K., & Bouzon, M. (2018). From a literature review to a multi-perspective framework for reverse logistics barriers and drivers. *Journal of Cleaner Production*, 187, 318-337.
- Grandia, J. (2016). Finding the missing link: Examining the mediating role of sustainable public procurement behaviour. *Journal of Cleaner Production*, 124, 183-190.
- Grilo, A., & Jardim-Goncalves, R. (2011). Challenging electronic procurement in the AEC sector: A BIM-based integrated perspective. *Automation in Construction*, 20(2), 107-114.
- Hardy, C. A., & Williams, S. P. (2008). E-government policy and practice: A theoretical and empirical exploration of public e-procurement. *Government Information Quarterly*, 25(2), 155-180.
- Hong, Y., Chan, D. W. M., Chan, A. P. C., & Yeung, J. F. Y. (2012), "Critical analysis of partnering research trend in construction journals", *Journal of Management in Engineering*, 28(2), 82-95.
- Ibem, E. O., & Laryea, S. (2015). e-Procurement use in the South African construction industry. *Journal of Information Technology in Construction*, 20, 364-384.
- Ibem, E. O., & Laryea, S. (2017). E-tendering in the South African construction industry. *International Journal of Construction Management*, 17(4), 310-328.

- Ibem, E. O., Aduwo, E. B., Afolabi, A. O., Oluwunmi, A. O., Tunji-Olayeni, P. F., Ayo-Vaughan, E. A., & Uwakonye, U. O. (2020). Electronic (e-) Procurement Adoption and Users' Experience in the Nigerian Construction Sector. *International Journal of Construction Education and Research*, 1-19.
- Ikram, M., Sroufe, R., & Zhang, Q. (2020). Prioritizing and overcoming barriers to integrated management system (IMS) implementation using AHP and G-TOPSIS. *Journal of Cleaner Production*, 254, 120121.
- Issa, R. R., Flood, I., & Caglasin, G. (2003). A survey of e-business implementation in the US construction industry. *Journal of Information Technology in Construction (ITcon)*, 8(2), 15-28.
- Lines, B. C., Perrenoud, A. J., Sullivan, K. T., Kashiwag, D. T., & Pesek, A. (2017). Implementing project delivery process improvements: Identification of resistance types and frequencies. *Journal of Management in Engineering*, 33(1), 04016031.
- Lou, E. C. W., & Alshawi, M. (2009). Critical success factors for e-tendering implementation in construction collaborative environments: people and process issues. *Journal of Information Technology in Construction*, 14, 98-109.
- Luo, T., Tan, Y., Langston, C., & Xue, X. (2019). Mapping the knowledge roadmap of low carbon building: A scientometric analysis. *Energy and Buildings*, 194, 163-176.
- Lupova-Henry, E., & Dotti, N. F. (2019). Governance of sustainable innovation: Moving beyond the hierarchy-market-network trichotomy? A systematic literature review using the 'who-how-what' framework. *Journal of Cleaner Production*, 210, 738-748.
- McMurray, A. J., Islam, M. M., Siwar, C., & Fien, J. (2014). Sustainable procurement in Malaysian organizations: Practices, barriers and opportunities. *Journal of Purchasing and Supply Management*, 20(3), 195-207.
- Meehan, J., & Bryde, D. J. (2015). A field-level examination of the adoption of sustainable procurement in the social housing sector. *International Journal of Operations and Production Management*, 35(7), 982-1004.
- Mehrbod, A., & Grilo, A. (2018). Tender calls search using a procurement product named entity recogniser. *Advanced Engineering Informatics*, 36, 216-228.
- Montalbán-Domingo, L., García-Segura, T., Amalia Sanz, M., & Pellicer, E. (2019). Social sustainability in delivery and procurement of public construction contracts. *Journal of management in engineering*, 35(2), 04018065.
- Naoum, S. G., & Egbu, C. (2016). Modern selection criteria for procurement methods in construction: A state-of-the-art literature review and a survey. *International Journal of Managing Projects in Business*, 9(2), 309-336.
- Osei-Kyei, R., & Chan, A. P. (2015). Review of studies on the Critical Success Factors for Public-Private Partnership (PPP) projects from 1990 to 2013. *International journal of project management*, 33(6), 1335-1346.
- Ramkumar, M., & Jenamani, M. (2015). Sustainability in supply chain through e-procurement—An assessment framework based on DANP and liberatore score. *IEEE Systems Journal*, 9(4), 1554-1564.
- Roman, A. V. (2017). Institutionalizing sustainability: A structural equation model of sustainable procurement in US public agencies. *Journal of cleaner production*, 143, 1048-1059.
- Ruparathna, R., & Hewage, K. (2015). Sustainable procurement in the Canadian construction industry: current practices, drivers and opportunities. *Journal of Cleaner Production*, 109, 305-314.

- Sayed, A. M., Assaf, S., Aldosary, A. S., Hassanain, M. A., & Abdallah, A. (2019). Drivers of e-bidding implementation in the Saudi Arabian construction industry. *Built Environment Project and Asset Management*, 10(1), 16-27.
- Seuring, S., & Müller, M. (2008). From a literature review to a conceptual framework for sustainable supply chain management. *Journal of cleaner production*, 16(15), 1699-1710.
- Tarazona\_Bermudez, G., G-Bustelo, B. C. P., Martínez, O. S., Alvarez, B. T., & Rojas, L. A. R. (2014). Reverse electronic auction web tool for B2B. *Computers in industry*, 65(5), 841-849.
- Walker, H., & Brammer, S. (2012). The relationship between sustainable procurement and e-procurement in the public sector. *International Journal of Production Economics*, 140(1), 256-268.
- Wong, C. H., & Sloan, B. (2006). An Empirical Survey of the UK Construction SMEs' E-Procurement Readiness from the E-Legal Aspects. *Journal of Construction Research*, 7(01n02), 81-97.
- Yevu, S. K. & Yu, A. T. W. (2019). The ecosystem of drivers for electronic procurement adoption for construction project procurement: A systematic review and future research directions. *Engineering, Construction and Architectural Management*, 27(2), 411-440.
- Yevu, S. K., Yu, A. T., Tetteh, M. O., & Antwi-Afari, M. F. (2020). Analytical methods for information technology benefits in the built environment: towards an integration model. *International Journal of Construction Management*, 1-12.
- Yevu, S. K., Yu, A. T. W., Darko, A., & Addy, M. N. (2021). Evaluation model for influences of driving forces for electronic procurement systems application in Ghanaian construction projects. *Journal of Construction Engineering and Management*, 147(8), 04021076.
- Yu, A. T. W., Yevu, S. K., & Nani, G. (2020). Towards an integration framework for promoting electronic procurement and sustainable procurement in the construction industry: A systematic literature review. *Journal of Cleaner Production*, 250, 119493.





## MICRO-CLIMATIC BENEFITS OF GREEN INFRASTRUCTURE (TREES) IN A HOUSING ESTATE IN ABUJA, NIGERIA

Tobi Eniolu Morakinyo<sup>1</sup>, Olumuyiwa Bayode Adegun<sup>2</sup>, Morisade O Adegbie<sup>3</sup> and Olawale Oreoluwa Olusoga<sup>4</sup>

<sup>1</sup>*School of Geography, University College Dublin, Ireland*

<sup>2,3,4</sup>*Department of Architecture, Federal University of Technology, Akure, Nigeria*

Urban overheating and the consequent outdoor thermal discomfort is plaguing many cities. Notably, housing development to cater for urban population explosion has increased grey infrastructure at the expense of urban vegetation which serves as green infrastructure. The integration of green infrastructure such as trees, green-roof and vertical greening is now being advocated and re-implemented in many cities around the world. This study presents an evaluation of the thermal benefits of greening a housing estate – King’s Park Estate in Abuja, Nigeria. Three different greening scenarios namely “current greening”, “one tree, one house” and “one street, one house plus street trees” were evaluated for their outdoor thermal comfort outcomes using the ENVI-met simulation tool. The ENVI-met software helps to simulate the micro-climatic impacts of the interactions within urban systems by assessing the effects of vegetation, materials etc. Result shows that planting one tree per house combined with street trees can offer up to 10°C reduction in Physiological Equivalent Temperature (PET). To have sustainable built environment, it is important to consider the addition of trees per house and on streets in current and future housing estate development.

Keywords: ENVI-met, green infrastructure, thermal comfort, urban design

### INTRODUCTION

Planning and designing climate -sensitive built environment through the adoption of green infrastructure helps to ameliorate the effect of rising urban temperatures and hence mitigate climate change. The loss of natural vegetation to urban housing development leads to a phenomenon of urban heat island effect (UHI). This is a situation of higher temperature in urban than the surrounding sub-urban and rural areas because of the aggregation of heat storing construction material during the daytime which are emitted at nighttime leading to significant warmer urban areas. This usually result from decrease in evaporative cooling and shading provided by trees.

---

<sup>1</sup> tobi.morakinyo@ucd.ie

<sup>2</sup> obadegun@futa.edu.ng

<sup>3</sup> moadegbie@futa.edu.ng

<sup>4</sup> ooolusoga@futa.edu.ng

The estimation that three billion people (about 40% of the world population) would need access to adequate housing by the year 2030 (UN-Habitat, 2012) predisposes urban areas to higher temperatures, where housing development is without adequate consideration to green infrastructure. Urban heat island is a notable emerging problem in Abuja, with the increase in development of housing estates. The city has been experiencing increase in both surface and atmospheric temperatures in recent years. Housing and infrastructural development has led to increase in impermeable surfaces and reduction in permeable surfaces (vegetal cover, naked ground) thus modifying the local climates such that built up areas experience higher day-time temperature. Isioye et al.'s (2020) mapping and analysis on Urban Heat Island (UHI) indicates that the peripheries parts of the city are more thermally comfortable than the inner-city segments, an area where the Housing Estate being studied is located. They found that 40% of the entire city coverage experiences bad or worse UHI effects. This situation highlights the need for increasing greening in the built-up areas. According to Adeyeri et al.'s (2007:66) analysis of relationship between land surface temperature and vegetation indices over Abuja, 'increasing vegetation cover led to a decreasing temperature gradient'.

The present study aims at evaluating the thermal benefit of the embracing green infrastructure implementation, in particular, tree-planting in the housing sector, using the ENVI-met model. The thermal environment of a housing estate – King's Park Estate in Abuja, Nigeria was evaluated in three different greening scenarios using the ENVI-met model. It involved simulating the built environment of the Housing Estate as an illustrative example while evaluating and comparing the micro-climate and thermal comfort improvement of three green coverage ratios within/around the estate.

## **GREENING URBAN HOUSING THROUGH GREEN INFRASTRUCTURE**

The integration of green infrastructure (trees, green-roof, and vertical greening) in housing estate development is an aspect of sustainable development in the building sector that promotes eco-friendly and sustainable environment. It seeks to minimize negative impacts on the environment while focusing on efficient use of resources including energy. Green infrastructure in housing development is crucial, currently, because of the significant contributions of the building sector to the global environmental and climate crisis. Building construction and operations accounts for 36% of global final energy use and 39% of energy-related carbon emissions (UNEP, 2018). The building sector is one of the sectors offering significant possibilities in tackling global crisis.

Green infrastructure in housing development and practices usually involve different approaches to reduce the environmental impacts of new and existing residential buildings. Landscaping is a notable aspect of greening within the built environment. This is akin to green infrastructure or nature-based based solutions for climate adaptation and mitigation which involves the integration of vegetation on ground and building surfaces. While its possibilities and advantages are increasingly been recognized in urban settings globally, intentional inclusion of green infrastructure has not become a regular practice/feature in many housing estates within major cities in Nigeria. In their investigation of property developers' willingness to invest in green features in Abuja, Oyewole et al. (2019) found that

landscaping/ecological features did not rank high among possible investment options for green housing development. Planting outdoor shady plants was also not top-ranking among investments made by residents who occupied a mass-developed housing estate in Akure (Adegun and Ayoola, 2019).

The benefits of green infrastructure in housing development abound. Scant number of studies conducted in Nigeria are showing these benefits in terms of thermal conditions, energy demand, and environmental quality. A field measurement study in Akure shows that tree-shading around a building can result in cooling up to 3 degrees in summer, resulting in 1500Kwh energy saving in a 6-month period (Morakinyo et al., 2013; 2014; 2016). Up to 79% reduction in solar heating through tree-shading is also possible, as an Owerri study shows (Ogueke et al., 2017). In Enugu, up to 70% reduction in solar radiation was observed, depending on the tree canopy, height, and specie (Obi, 2014). Similar result was obtained in Lokoja (Alabi and Christian, 2013). Air pollution mitigation and carbon sequestration were reported in a quasi-experimental study within residential estates in the Ibadan (Adesoye et al., 2019). Temperature and CO<sub>2</sub> were higher around buildings and precincts with fewer or no trees.

## **THE ROLE OF SIMULATION AND MODELLING IN UNDERSTANDING GREEN INFRASTRUCTURE BENEFITS**

To understand and quantify the thermal and environmental benefits green infrastructure, conventional field measurement approach is useful. It provides the actual magnitude of the chosen indicator with limited error. However, it is an expensive approach as the quantity of instruments needed increases with increasing spatial resolution of measurement points. Besides, the approach does not offer the opportunity for pre-development evaluation of the environmental impact of green infrastructure implementation. On the other hand, modelling involves abstraction of reality using mathematical equation and simplification assumptions, it is however offering the opportunity to evaluate "what-if" scenarios thereby informing decision making.

To model the vegetation impact on urban microclimate, several simulation tools/models have been developed and have been categorized into two broad groups (Yang et.al 2018): the Energy Balance Models (EBM) such as RayMan, SOLWEIG (Solar LongWave Environmental Irrandiance Geometry), green-CTTC (Cluster Thermal Time Constant), TEB-Veg (Town Energy Balance); and the Computational Fluid Dynamics (CFD) models such as OpenFOAM, FLUENT and STAR-CCM+, PHOENICS with the plant canopy module FOLIAGE and the CFD-based ENVI-met model. A review of vegetation evaluation models by Yang et.al (2018) reveals that the CFD-based models are more used than the EBM and about 50% of reviewed literature used ENVI-met. This is mainly due to its geometric domain structure, and the ability to the embedded plant model to mimic the radiation and aerodynamic effects of vegetation coupled with the atmospheric (Heat, humidity and wind) model, a combination not found in other counterparts.

As an example of the ENVI-met model's application is a study by Morakinyo et. al (2016) where ENVI-met was integrated with the Building Energy Simulation (BES) program, EnergyPlus to assess the impact of tree-shading on indoor and outdoor

summer thermal conditions of two similar buildings, where one is shaded by trees, and the other unshaded (see Figure 1). Other studies (Tsoka et.al, 2018, and Lobaccaro and Acero, 2015 and Shi et.al, 2020) have applied the tool in evaluating urban heat mitigation strategies such cool roof and pavements, façade greening, water bodies and urban morphology modification, among others.

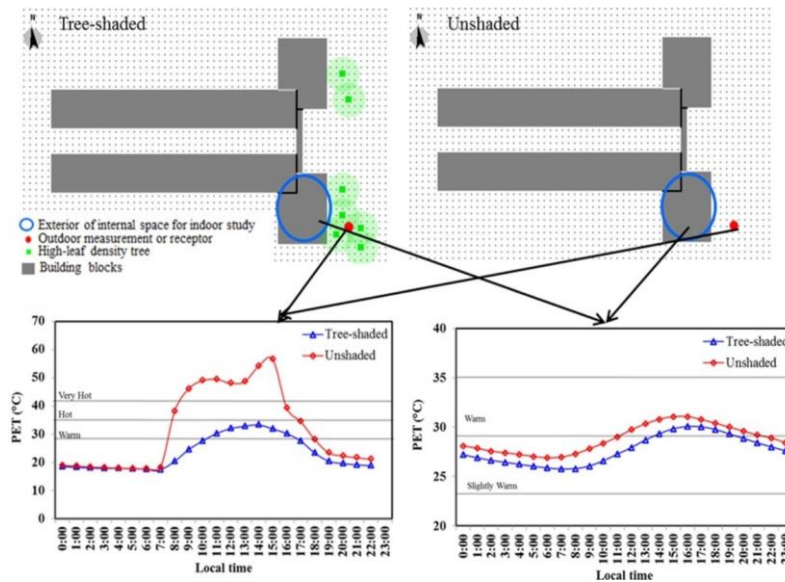

Figure 1 – Hourly thermal comfort profile of outdoor and indoor area of a tree-shaded and unshaded buildings (Morakinyo et.al, 2016).

## STUDY AREA AND PREVAILING CLIMATE

### The King’s Park Housing Estate, Abuja

Abuja, where the study site is located is part of the Federal Capital Territory which covers approximately 400sqm. Its undulating terrain is located roughly 840m above sea level and receives between 1100 and 1600mm of precipitation annually (Itiowe et al., 2019). The climate is tropical – the koppen classification. It is yearlong warm or hot, with an average daily high temperature of only 32 degrees. The temperature can reach 40 degrees during the day in the dry season, although dry winds could at times lower it up to 12 degrees at night (Abubakar 2014).

The Federal Government of Nigeria has historically been involved in housing provision, infrastructure, and services in Abuja under the Federal Capital Territory Administration (FCTA) and Federal Capital Development Authority (FCDA). Many housing estates were developed through these agencies. With increasing population and demand for housing, Mass Housing through Public–Private Partnership (PPP) was flagged off around the year 2000. Government sought active participation of the private sector towards housing delivery through granting land to real estate developers (Ukoje and Kanu, 2014). The study site, the Kings Park housing estate is one of the privately developed housing schemes in Abuja. It is on Latitude 9° 0' 55.1" N, Longitude 7° 25' 44.4"E, located at the Kukwaba district, along the Umaru Musa Yardua Expressway, near Abuja Games Village (See Figure 2). Seating on a 36,254m<sup>2</sup> of land, the housing estate contains over 60 buildings with dwelling units on multiple floors distributed into 3-bedroom, 4-bedroom, 5-bedroom apartments.

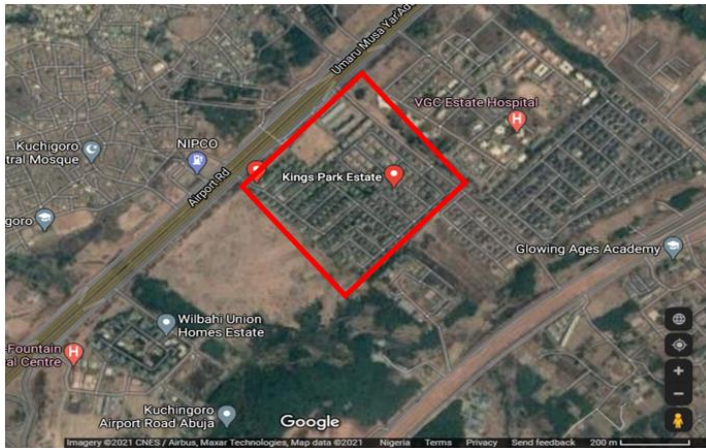

Figure 2. Satellite Image of Kings Park Estate, Abuja, Nigeria

## METHODOLOGY

### Description of ENVI-met

As earlier mentioned, this study was carried using the urban micro-climate simulation tool, ENVI-met (Bruse and Fler, 1998; Huttner, 2012) which has ability to simulate at high spatial (0.5 to 5 m) and temporal (1 to 5 sec) resolution the surface-plant-air interactions resulting in near-accurate modelling of microclimatic parameters in a complex environment with buildings and surfaces of unique or diverse materials and greenery. ENVI-met treats plants as porous, living and dynamical bodies with adjustable morphological characteristics and can interact through evapotranspiration and energy absorption with the neighboring environment. These capabilities are crucial for this study given the aim to apply the understanding thermal benefit of green infrastructures (i.e. trees) reasonable accuracy. The model is widely adopted by practitioners and researchers interested in evaluating the effectiveness of certain urban heat mitigation and adaptation strategies such as urban greenery and water bodies (Morakinyo et.al, 2020). Further information on the model, including all embedded equations, documentation and downloads can be found at <http://www.envi-met.info>.

### Scenario development, model setting, initialization

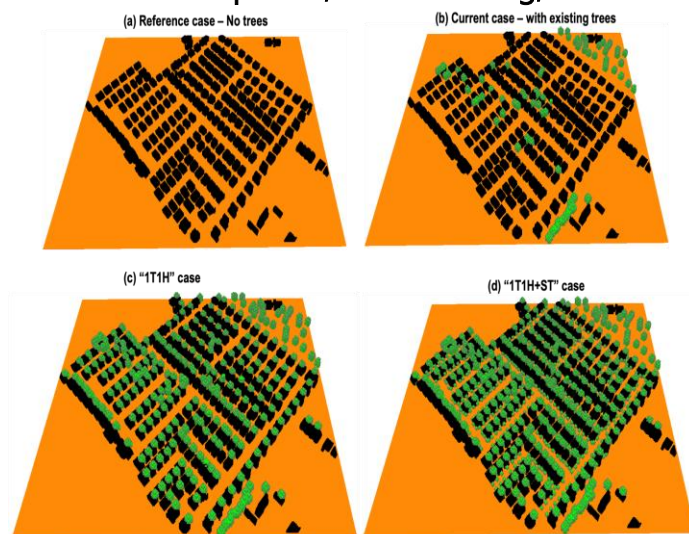

Figure 3: Greenery and building coverage extent under various scenarios (a) Reference case, (b) current case, (c) "1T1H" case, and (d) "1T1H+ST" case.

In ENVI-met's SPACES, we developed the built environment of Kings Park Estate in a horizontal computational domain sized 616 X 510 m<sup>2</sup> with a grid resolution 2m X 2m and a vertical height of 30m at 3m vertical resolution. To ensure enough distance before the upstream building and after the downstream building and to minimize edge-effect, ten (10) nested grids were added to the computational domain.

To model the buildings, we made use of the building footprint from google map and uniform height of 10m was applied to all buildings. To achieve the goal of the study, four scenarios of grey-green were developed (see Figure 3):

- 1) **Reference case** – a scenario with “no trees” within the estate.
- 2) **Current case** – a scenario with observable limited existing tree coverage from google map
- 3) **1T1H case** – this scenario assumes a proposal and adoption of “one tree(1T), one house(1H)”.
- 4) **IT1H+ST case** - this scenario assumes the adoption of “one tree(1T), one house(1H)”, with added street trees (ST) on all roads with the estate.

For the last two cases, we assumed a dense foliage medium height tree (Figure 4a) on the Eastern/North-Eastern side of the all the building within the domain while small palm trees (Figure 4b) were added at intervals on all streets and roads in the modelled estate.

To initialize the simulation, a simple forcing mode was employed representing a typical hot-dry day in Abuja with minimum and maximum hourly air temperature set to 21-33°C, minimum and maximum relative humidity at 27 - 53%, prevailing wind speed at 2.00m/s and direction 40°.

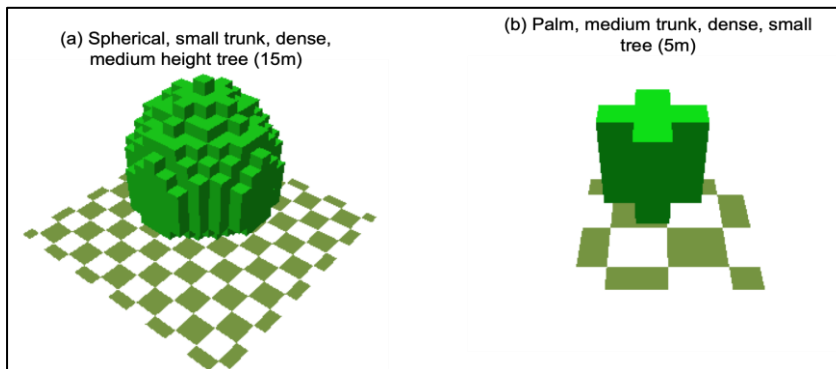

Figure 4: Model of tree added in the simulation

To assess the outdoor thermal comfort and the impact of tree-shades, a thermal comfort index, Physiological Equivalent Temperature (PET) was adopted. PET is defined as equivalent to the air temperature that is required in a standardized indoor setting (without wind and solar radiation), to balance heat budget of the human body with the same core and skin temperature as under the complex outdoor conditions to be assessed (Hoppe, 1999). Following the calculation done, obtained values can be categorized to different thermal sensation and stress classes (Table 1) for a standardized person characterized by a work metabolism of 80W of light activity, 0.9 clo of heat resistance from clothing in a tropical climate.



**Table 1: PET range and corresponding human thermal perception and physiological stress in stub-tropical climate**

PET (°C)	Thermal Perception	Physiological stress
<13	Very cold	Extreme cold stress
13 – 17	Cold	Strong cold stress
17 – 21	Cool	Moderate cold stress
21 – 25	Slightly cool	Slight cold stress
25 – 29	Neutral	No thermal stress
29 – 33	Slightly Warm	Slight heat stress
33 – 37	Warm	Moderate heat stress
37 – 41	Hot	Strong heat stress
>41	Very Hot	Extreme heat stress

## RESULTS AND DISCUSSION

### Effect of neighborhood trees on the micro-climate and thermal comfort

We present here the simulation results of Physiologically Equivalent Temperature (PET), an outdoor thermal comfort that is a function of air temperature, humidity, wind speed and mean radiant temperature. Figure 5 shows the distribution of the simulated PET within and around King Park’s Estate at 3PM (the hottest period of the day) for the four scenarios. Irrespective of the case, the range of 35.7 – 55.6°C observed indicated a thermal sensation of between “Warm” and “Very Hot” (according to Table 1) mostly experienced around the buildings shadow and open-sky area, respectively. However, with the addition of trees near the buildings and streets/roads, the coverage of lowered PET increased significantly as the tree coverage increased as shown in the figure 5 where the red/pink zones in the reference and current cases, changed to lowered PET values. This observation is mainly due to the reduction of direct solar radiation by the tree canopies leading to lower radiant temperature under and around the tree canopies.

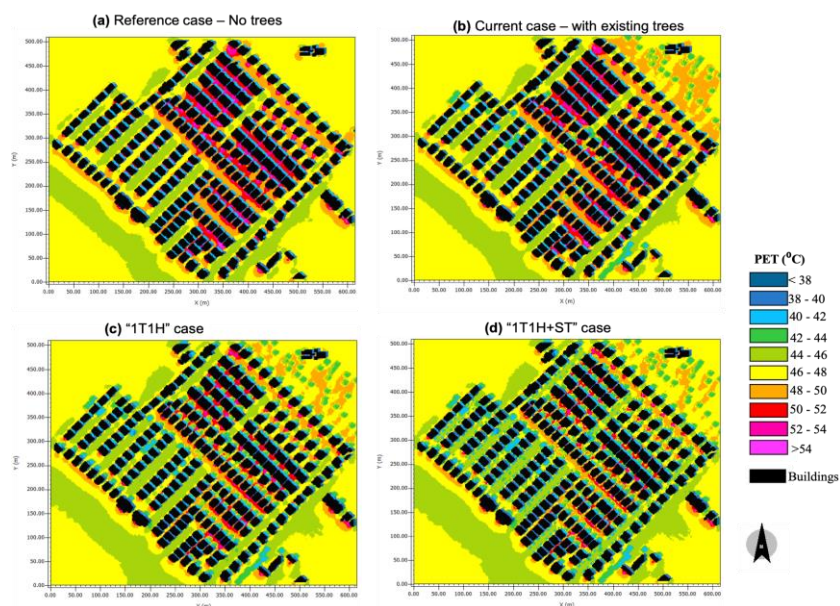

Figure 5: Spatial distribution of simulated PET within and around King Park’s Estate at 3PM for (a) Reference case (b) current case , (c) “1T1H” case, and (d) “1T1H+ST” case.

To quantify the thermal effect of the implemented neighborhood greening, Figure 6 shows the difference in PET of the reference situation – no tree and (a) current situation (b) when an assumed “one tree, one house” (1T1H case) and (c) “one tree house and street trees” (“1T1H+ST” case) at 3PM, the period of maximum temperature (i.e. peak thermal discomfort).

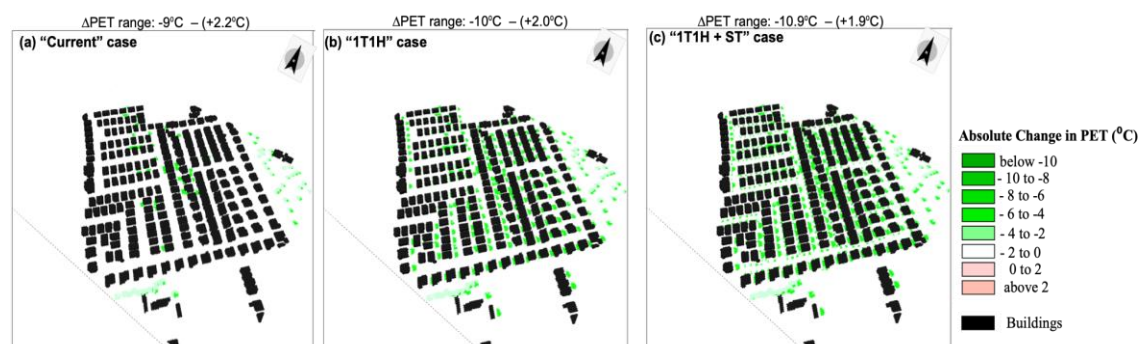

Figure 6: Spatial distribution of simulated change in PET within and around King Park's Estate at 3PM between the Reference case and (a) current case , (b) “1T1H” case, and (c) “1T1H+ST” case.

A similar range of absolute difference:  $-9^{\circ}\text{C} - (+2.2^{\circ}\text{C})$ ,  $-10^{\circ}\text{C} - (+2.0^{\circ}\text{C})$ , and  $-10.9^{\circ}\text{C} - (+1.9^{\circ}\text{C})$  was observed in the “current”, “1T1H” and “1T1H+ST” case, respectively. Spatially, variable magnitude of PET reduction can be observed in the other cases relative to the reference. Highest reduction of up to  $10^{\circ}\text{C}$  were found under individual tree canopy and streets or areas with overlapping tree crowns. The areal magnitude of the PET reduction is obviously dependent of tree coverage ratio. With the current case, the most grids experience not more than  $2^{\circ}\text{C}$   $\Delta\text{PET}$  while the coverage of intensified reduction are observed in the “1T1H” and “1T1H+ST” cases, the latter giving the most area coverage of the increased PET reduction especially at the inner core of the estate.

## DISCUSSION AND CONCLUSION

This study has shown the urban overheating mitigation and thermal comfort improvement of tree-planting in an existing tropical housing estate using the ENVI-mt simulation tool. The ground areas and building walls around trees were shown to have reduced radiant temperature and improvement in thermal comfort. Similar findings were observed in earlier studies from outside Nigeria (See for example, Wang et. al, 2019; Lee and Mayer, 2018, and Morakinyo et.al, 2020) where greening mitigation strategies have been proven to improve the thermal environment of residential neighborhood. Other greening strategies such green-roof, façade greening, cool materials and water bodies can be simultaneously added in certain areas where improved cooling is desired.

Several aspects are not considered in this study but could be the focus of future research using the same simulation tools and/or field measurement approach. For instance, it is possible to study the effect of different ground surface, and walling materials, whereas concrete material was assumed is the present study. Also, similar tree species are assumed and implemented while it is possible to model, implement and evaluate the effect of different tree species (Morakinyo et.al., 2017). To make more objective decision, representative prevailing climate condition can also be tested. Here we evaluated with the typical dry season condition occurring



between December and January in Abuja. Simulation for the wet season can also be conducted. Based on the overall outcome of this study, policy makers, architects, urban designers and developers are encouraged to strongly consider the addition of trees per house and on streets in current and future housing estate development.

## REFERENCES

- Abubakar, I. R. (2014). Abuja City profile. *Cities*, 41: 81-91.
- Adegun, O. B., & Ayoola, H. A. (2019). Adaptation to Heat Stress within Housing Estates in Akure, Nigeria. *Covenant Journal of Research in the Built Environment*, 7(1): 49-60.
- Adesoye, T., Sridhar, M., Coker, A., & Adejumo, M. (2019). Landscaping of Residential Estates as a Mitigation Measure to Reduce Carbon Dioxide and Temperature Levels in Inner Ibadan City, Nigeria, *International Journal of Environmental Monitoring and Analysis*, 7(5): 93-102.
- Adeyeri, O. E., Akinsanola, A. A., & Ishola, K. A. (2017). Investigating surface urban heat island characteristics over Abuja, Nigeria: Relationship between land surface temperature and multiple vegetation indices. *Remote Sensing Applications: Society and Environment*, 7:57-68.
- Alabi, M. O., & Christian, E. I. (2013). Street Tree Canopy Cover Variation Effects on Temperature in Lokoja, Nigeria. *Journal of Agriculture and Environmental Sciences*, 2(2):25-31.
- Balogun, A. A., Morakinyo, T. E., & Adegun, O. B. (2014). Effect of tree-shading on energy demand of two similar buildings. *Energy and Buildings*, 81: 305-315.
- Bruse, M., & Fleer, H. (1998). Simulating surface-plant-air interactions inside urban environments with a three-dimensional numerical model. *Environmental Modelling & Software*, 13(3-4), 373-384.
- Höppe, P. (1999). The physiological equivalent temperature—a universal index for the biometeorological assessment of the thermal environment. *International journal of Biometeorology*, 43(2): 71-75.
- Huttner, S. (2012). Further development and application of the 3D microclimate simulation ENVI-met. Doctoral dissertation, Universitätsbibliothek Mainz.
- Isioye, O. A., Ikwueze, H. U., & Akomolafe, E. A. (2020). Urban Heat Island Effects and Thermal Comfort in Abuja Municipal Area Council of Nigeria. *FUTY Journal of the Environment*, 14(2):19-34.
- Itiowe, T., Hassan, S. M., & Agidi, V. A. (2019). Analysis of Rainfall Trends and Patterns in Abuja, Nigeria. *Current Journal of Applied Science and Technology*, pp.1-7.
- Lee, H. & Mayer, H. (2018). Maximum extent of human heat stress reduction on building areas due to urban greening. *Urban Forestry & Urban Greening*, 32: 154-167.
- Lobaccaro, G., & Acero, J. A. (2015). Comparative analysis of green actions to improve outdoor thermal comfort inside typical urban street canyons. *Urban Climate*, 14: 251-267.
- Morakinyo, T. E., Ouyang, W., Lau, K. K. L., Ren, C., & Ng, E. (2020). Right tree, right place (urban canyon): Tree species selection approach for optimum urban heat mitigation-development and evaluation. *Science of The Total Environment*, 719: 137461.

- Morakinyo, T. E., Balogun, A. A., & Adegun, O. B. (2013). Comparing the effect of trees on thermal conditions of two typical urban buildings. *Urban Climate*, 3: 76-93.
- Morakinyo, T. E., Dahanayake, K. K. C., Adegun, O. B., & Balogun, A. A. (2016). Modelling the effect of tree-shading on summer indoor and outdoor thermal condition of two similar buildings in a Nigerian university. *Energy and Buildings*, 130: 721-732.
- Obi, N. I. (2014). The influence of vegetation on microclimate in hot humid tropical environment-a case of Enugu urban. *International Journal of Energy and Environmental Research*, 2(2), pp.28-38.
- Ogueke, N. V., Nwakanma, A. F., Ngharamike, T., Nduka, C. F., Onyejizu, E. F., & Anyanwu, E. E., (2017). Energy-saving potentials of some local trees. *Energy Efficiency*, 10(1): 171-181.
- Oyewole, M. O., Ojutalayo, A. A., & Araloyin, F. M. (2019). Developers 'willingness to invest in green features in Abuja, Nigeria, *Smart and Sustainable Built Environment*, 8 (3): 206-219.
- Shi, D., Song, J., Huang, J., Zhuang, C., Guo, R., & Gao, Y. (2020). Synergistic cooling effects (SCEs) of urban green-blue spaces on local thermal environment: A case study in Chongqing, China. *Sustainable Cities and Society*, 55, 102065.
- Tsoka, S., Tsikaloudaki, A., & Theodosiou, T. (2018). Analyzing the ENVI-met microclimate model's performance and assessing cool materials and urban vegetation applications—A review. *Sustainable Cities and Society*, 43, 55-76.
- Ukoje, J. E., & Kanu, K. U. (2014). Implementation and the challenges of the mass housing scheme in Abuja, Nigeria. *American International Journal of Contemporary Research*, 4(4): 209-218.
- United Nations Environment Programme, (2018). *Global Status Report: Towards a zero-emission, efficient and resilient buildings and construction sector*. Retrieved from [www.unep.org/resources/global-status-report-2018](http://www.unep.org/resources/global-status-report-2018)
- UN-Habitat, (2012). *Going Green: Handbook of Sustainable Housing Practices in Developing Countries*. UN-Habitat, Nairobi.
- Wang, Y., Zhou, D., Wang, Y., Fang, Y., Yuan, Y., & Lv, L. (2019). Comparative study of urban residential design and microclimate characteristics based on ENVI-met simulation. *Indoor and Built Environment*, 28(9): 1200-1216.



# MODELLING OF FUTURE LAND USE/LAND COVER CHANGE DYNAMICS IN LAGOS, NIGERIA USING CELLULAR AUTOMATA AND MARKOV CHAIN (CA-MARKOV) MODEL

Auwalu Faisal Koko<sup>1</sup>, Wu Yue<sup>2</sup>, Muhammed Bello<sup>3</sup> and Ghali Abdullahi Abubakar<sup>4</sup>

<sup>1,2</sup>College of Civil Engineering and Architecture, Zhejiang University, China

<sup>3</sup>Department of Architecture, Kaduna Polytechnic, Kaduna State, Nigeria

<sup>4</sup>College of Environmental and Resource Sciences, Zhejiang University, China

Many cities in developing countries have witnessed rapid urbanization, resulting in various land use/land cover (LULC) changes. However, few studies focus on the growth and development of African cities. As a result, this study aims to predict the future land use/land cover of Lagos, Nigeria, from 2020-2050 using a combination of cellular automata and the Markov Chain model (CA-Markov). The CA-Markov model utilises historical land cover data and transition probabilities to simulate future LULC patterns through Geographic Information System (GIS) techniques. In this study, the land use/land cover pattern of Lagos was modelled and validated using the city's historical maps. The maps were derived from satellite images using the maximum likelihood classification. The historical LULC indicates that Lagos had witnessed an increase and decrease in the city's different land-uses, comprising built-up areas, vegetation, barren land, and water bodies. Over the last 20 years, the city's built-up areas and barren land have increased by approximately 19.81 km<sup>2</sup> and 3.13 km<sup>2</sup> per annum, while vegetation and water bodies have decreased annually by 15.89 km<sup>2</sup> and 7.06 km<sup>2</sup>, respectively. The Land Change Modeler (LCM) of TerrSet software was utilised in simulating the CA-Markov model to forecast the city's future land cover based on the historical LULC trends. The predicted result reveals that in 29 years, Lagos will experience a notable increase in built-up areas from 1255.91 km<sup>2</sup> in 2020 to 1544.95 km<sup>2</sup> in 2050, while barren land will expand by 257.62 km<sup>2</sup>. This change is expected to occur at the expense of vegetation, and water bodies, which will decline by approximately 314.76 km<sup>2</sup>, and 231.90 km<sup>2</sup>. Therefore, this study provides critical data useful to urban planners, policy, and decision-makers in formulating strategies and initiatives for a sustainable built environment in Africa's most populous city.

Keywords: CA Markov, Geographic Information Systems(GIS), land use/land cover change, LULC prediction, remotely sensed data

---

<sup>1</sup> 11812112@zju.edu.cn

<sup>2</sup> ywu100@zju.edu.cn

<sup>3</sup> mbello02@kadunapolytechnic.edu.ng

<sup>4</sup> ghaliaa@zju.edu.cn

## INTRODUCTION

The recent changes in land use/land cover have become an issue of utmost environmental concern globally due to their unprecedented impact on the ecosystem (Alawamy, Balasundram, Hanif, & Teh, 2020; Halmy, Gessler, Hicke, & Salem, 2015). The continuous trend of socio-economic development and increasing population in most regions of the world have contributed to the wide-ranging modification of the earth surfaces, particularly land use/land cover (Gong, Yuan, Fan, & Stott, 2015). Several studies have indicated significant changes among different land-uses due to human-induced activities (Shi et al., 2019; Song & Deng, 2017; Yang, Yang, Li, & Huang, 2021). The consequences of these alterations have impacted directly and indirectly to the environment and climate. Some of the adverse effects of these changes include loss of fertile land, water resources, and biodiversity, forest degradation, deforestation, depletion of the ozone layer, emission of greenhouse gases (GHG), and urban heat island development (Al-sharif & Pradhan, 2014; Gogoi et al., 2019; Xu, Xie, Qi, Luo, & Wang, 2018; Zhong et al., 2017). Therefore, examining spatiotemporal temporal changes in LULC plays a crucial role in formulating policies on managing the built environment and natural resources. It is appropriate to analyse LULC changes and forecast the possible future changes for effective and long-term planning (Du et al., 2019; Haque & Basak, 2017). Such studies envisaging environmental alterations are of utmost importance in cities of developing countries such as Nigeria, having rapid urbanization with associated change in land-uses.

The use of remote sensing techniques has provided numerous ways of producing land use/land cover maps of a given area and generating statistical data for analyzing LULC change dynamics (Ayele et al., 2018; Koko, Yue, Abubakar, Hamed, & Alabsi, 2020). Butt, Shabbir, Ahmad, and Aziz (2015) opine that the availability of remotely sensed data and their advantages of high-resolution spatiotemporal images, when incorporated with GIS techniques, has provided a potential means of detecting land cover change scenarios on the earth's surface. The increase in satellite platforms has contributed to faster, continuous, and regular images, which help manage and forecast changes in various environmental studies (Abubakar et al., 2020). Such data assist in planning and remedying the negative effects associated with the alteration of land-uses. Previous studies have identified several models for detecting and predicting changes in LULC. Such models include empirical models (Cromley & Hanink, 1999; Veldkamp & Fresco, 1996), agent-based models (Rouchier, Bousquet, Requier-Desjardins, & Antona, 2001), evolutionary models (Sahebgharani, 2016), Cellular automata (CA), and Markov chain model (Abdulrahman & Ameen, 2020; Liping, Yujun, & Saeed, 2018). However, the integration of Cellular automata and Markov chain models are the most widely used methods for the LULC change prediction due to its spatiotemporal consideration of land use/land cover (Aneesha Satya, Shashi, & Deva, 2020).

Several studies have analysed spatiotemporal land use/land cover changes using various satellite data and GIS techniques while employing the CA-Markov model to predict the future LULC. A comprehensive review of the Cellular Automata and Markov chain modelling techniques for geospatial environment simulation can be found in Ghosh et al. (2017). In a recent study carried out by Koko et al. (2020), the

future land use/land cover pattern of Zaria city, Nigeria, was predicted using an integrated CA-Markov chain model. Similarly, Aneesha Satya et al. (2020) used open-source GIS methods to simulated the future land cover scenario in Warangal city, India. Wang and Maduako (2018) studied the spatio-temporal urban growth dynamics of the Lagos Metropolitan Region in Nigeria using a Hybrid approach for land cover modelling and prediction. Liping et al. (2018) analysed and predicted the LULC changes in the hilly region of Jiangle county, China, using remote sensing and GIS techniques. Gidey, Dikinya, Sebego, Segosebe, and Zenebe (2017), used the Cellular Automata and Markov Chain in predicting the future LULC scenarios in Raya, Northern Ethiopia. The integrated CA-Markov model has also been utilised in projecting the land cover changes in the urban renewal areas of Hong Kong (Zheng, Shen, Wang, & Hong, 2015). The result of these studies have demonstrated the efficiency of the integrated modelling approach for LULC prediction and provided credible data for informed decision-making on the management of land uses and natural resources.

Although numerous land use/land cover studies have been carried out on cities in different geographical regions, very few studies monitored and predicted the land use/land cover dynamics of rapidly growing cities in Africa, particularly Lagos, which is Nigeria's most populous city. The focus of such studies has always been the metropolitan area of the city, without any studies covering the entire city of Lagos. Therefore, to fill this existing research gap, the present study detected and modelled the future land use/land cover of Lagos, Nigeria, using an integrated modelling method, i.e., CA-Markov. To achieve this, the study; (i) derived and analysed the historical LULC data of Lagos city using remotely sensed images and GIS techniques, (ii) modelled and validated the simulated LULC pattern of Lagos in 2020, (iii) utilised the transition area matrix and transition probability matrix generated for the period between 2010 and 2020 to predict Lagos city's future LULC pattern in 2050. The findings of this paper provided the essential land use/land cover information that could be used as scientific data with a view of comprehensively understanding and planning the entire city of Lagos through environmental and developmental programs that are crucial to achieving sustainable development of the city.

## **MATERIALS AND METHODS**

### **Study area**

Lagos is located in a low-lying area in Nigeria's south-western zone, stretching over a landmass of approximately 3,577 square kilometers (Lagos State Government, 2020). The city has a latitudinal extent between 6° 15' and 6° 45' N, and a longitudinal coverage between 2°45' and 4°15' E as shown in Figure 1. It borders the Atlantic Ocean to the south, the Benin Republic to the west, and Ogun state to the north and east. Lagos has tropical rainforest climatic conditions, similar to other southern regions of Nigeria, with high temperatures and humidity throughout the year. It has an average annual precipitation of 1600mm and an average yearly temperature of 25°C (Jimoh et al., 2018). Lagos has two main seasons: a wet season, which occurs from April to October, and a dry season witnessed from November to March. These distinct seasons are often accompanied by dry Harmattan winds between December and February.

### Location Map of the Study Area (Showing the Geographical Location of Lagos)

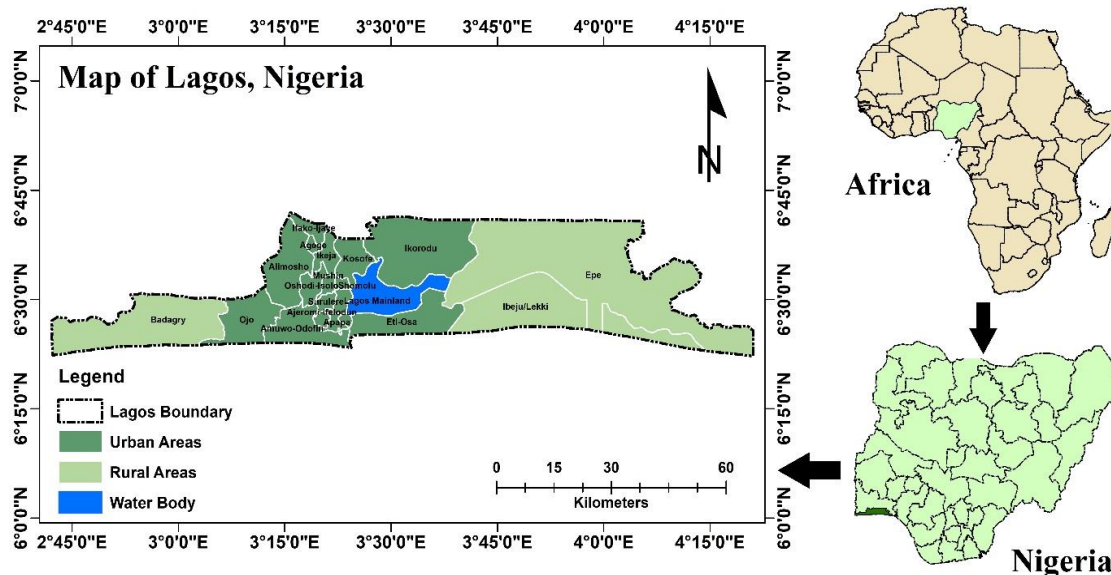

Figure 1: Geographical location of Lagos, Nigeria

Like many other rapidly growing urban centers, Lagos has witnessed increased urban development and expansion due to rapid urbanization. This development has altered the city's land-use/land cover and transformed Lagos from a port city to Nigeria's most vibrant socio-economic hub, contributing over 30% of its Gross Domestic Product (GDP). The city of Lagos is a crucial contributor to Nigeria's non-oil sector, with over 60% of Nigeria's commercial and industrial activities (Lagos State Government, 2020). The availability of urban infrastructures has contributed immensely to the migration of the people to the city. Lagos having nearly 80% of Nigeria's international flight traffic and over 70% of Nigeria's cargo freight, has helped connect the city to different parts of the world. Lagos city's population had rapidly increased from about 4.8 million in 1990 to approximately 14.4 million in 2020. The city is projected to have approximately 24.4 million inhabitants by 2035, which is expected to increase twice by 2050, making the city one of the world's top three largest cities (Population Stat, 2020). Hence, the motivation for selecting Lagos as the study area mainly emanated from the city's rapid urbanization and increased population, which contributes to the numerous environmental challenges that affect the city.

## METHODS

To achieve the study's aim. The procedures were divided into two main steps: i) the generation of spatiotemporal land-use/land cover data from remotely sensed satellite images and ii) using the acquired LULC data to forecast the future changes in LULC patterns. For the generation of spatiotemporal LULC data, Landsat (level 1) satellite images of the study area were acquired without any cost from the United States Geological Survey (USGS) website (<https://earthexplorer.usgs.gov/>) for 2000, 2010, and 2020. The images were obtained during the dry season between October and February to acquire cloud-free images and avoid atmospheric distortions. The satellite data comprises Landsat ETM+ for 2000 and 2010 and Landsat OLI for 2020.

Google earth images of the study area were also obtained to ascertain the actual ground conditions during the study's different time nodes.

The methodological flowchart of the study is illustrated in Figure 2. It consists of two (2) main sections. Section (a) demonstrates the various steps involved in the classification of LULC and its accuracy assessment, while section (b) illustrates the procedure utilised for modelling the future LULC pattern of the study area. The various processes utilised are further discussed below.

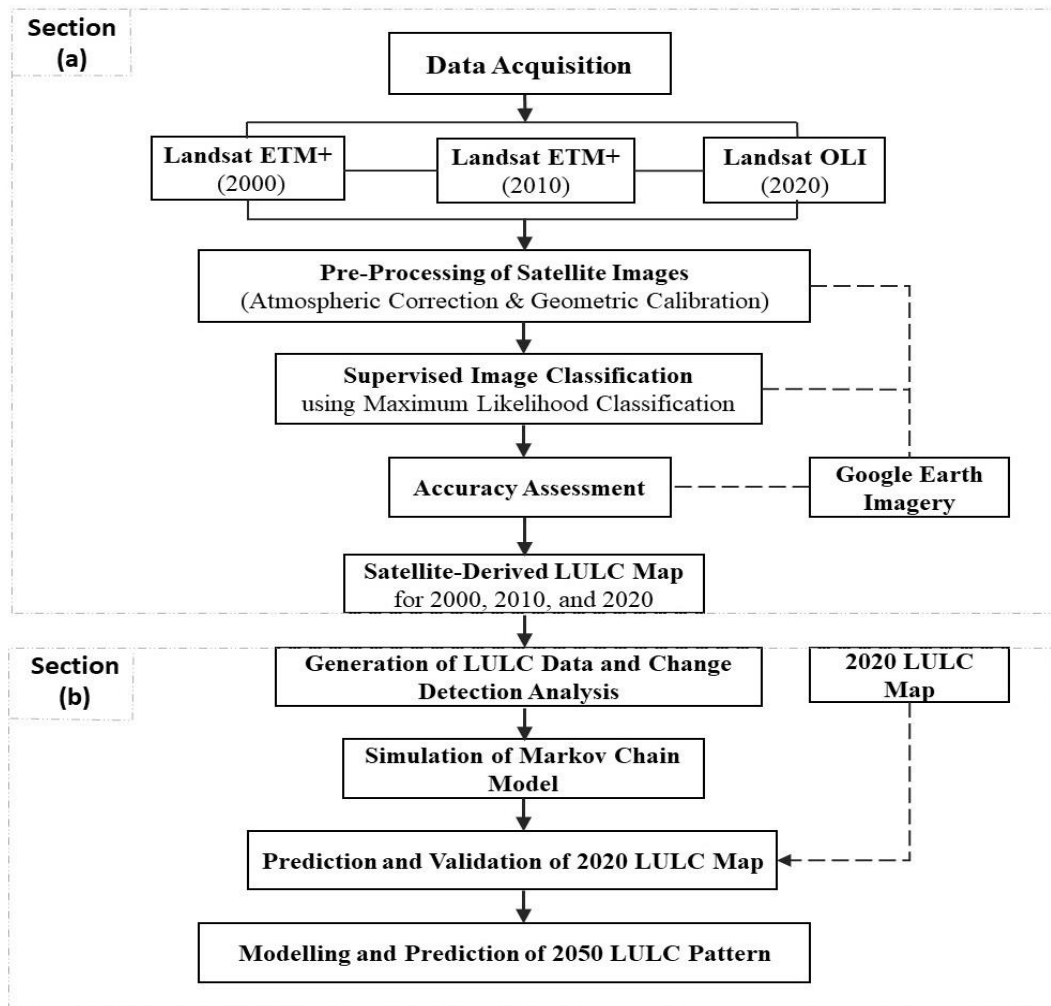

Figure 2: Methodological flowchart of the study comprising (a) LULC classification procedure and (b) LULC modelling steps.

### Image pre-processing and classification

The study utilised Landsat Enhanced Thematic Mapper Plus (ETM+) and Landsat 8 Operational Land Imager (OLI) to derive the LULC data and model the study area's future change dynamics. It acquired full scenes of datasets for three different periods (i.e., 2000, 2010, and 2020). The images were downloaded at a spatial resolution of 30m having the visible, near-infrared (NIR), and mid-infrared (MIR). However, processing these satellite images or remotely sensed data could be challenging due to few distortions in acquiring systems or sensors (Koko et al., 2020). Therefore, prior to image classification, satellite images 'pre-processing is vital in minimizing errors and building a more reliable connection between the actual ground condition and satellite data (Coppin, Jonckheere, Nackaerts, Muys,

& Lambin, 2010). The study utilised pre-processing operations that included gap filling, sub-setting, radiometric, atmospheric, and geometric corrections. These operations were performed in ArcGIS 10.7.1 and ENVI 5.3 image processing software. All the images were mapped using WGS84 ellipsoid and georeferenced to the Universal Transverse Mercator (UTM) Zone 31N. The classification of images aided in cataloguing the entire pixels of the individual satellite images into land use/land cover classes using thematic maps. It assigns spectral signatures to land-use categories based on the diverse LULC classes 'reflectance attributes (Cheruto, Kauti, Kisangau, & Kariuki, 2016). The Maximum Likelihood Classifier (MLC) algorithm was used for the classification of images. The images were classified into four broad classes comprising the built-up/urban area, vegetation, bare soil/barren land, and water bodies. The description of each LULC class is presented in Table 1.

**Table 1: Description of various LULC classes adopted in this study.**

S/No.	Broad LULC Classification	Description
1.	Urban/Built-Up Area	Areas covered by buildings and other human-made structures having residential, commercial, mixed-use, and industrial facilities/services
2.	Vegetation	It includes areas covering various shrubland, mixed forests, agricultural land, farmlands, crop fields, and other plantations.
3.	Bare Soil	Comprises areas having no vegetation cover. Such lands include bare ground, exposed soil and rock surfaces, quarries, construction, and excavation site.
4.	Water Bodies	Includes areas such as swamps, lakes, streams, rivers, reservoirs, and ponds

### Accuracy assessment of classified images

Accuracy assessment is a vital process in land use/land cover classification. It evaluates the reliability of classified LULC maps derived from satellite images. Satellite images are usually compared with ground truth data using land-use maps, field observations, and other high-resolution satellite images such as google earth imagery. In this study, the accuracy assessment was conducted using high-resolution satellite imagery retrieved from Google Earth Pro (Version 7.3.3.). The satellite images of 28th January 2010 and 7th January 2020 were used to validate the classified LULC maps. The study employed a random sampling method to generate validation points for each LULC category. A total of 200 reference points were randomly created, having approximately 50 sample points per LULC class as suggested by Congalton (1991). The reference points were compared with the classified land use/land cover map of 2010 and 2020 to produce an error matrix. The LULC classification accuracy was evaluated using various measures obtained from the error matrix, which mainly includes the overall accuracy and kappa coefficient (k). An overall accuracy above 80% is often considered an acceptable land use/land cover classification (Rwanga & Ndambuki, 2017). A kappa coefficient above 0.8 signifies an excellent agreement. 'k' values between 0.4 and 0.6 represent a good agreement, whereas values less than 0.4 signifying a poor agreement (Foody, 2004).

### Modelling of future LULC pattern

The spatiotemporal modelling of the future LULC distribution was carried out using Lagos 'historical land use/land cover data between 2010 and 2020. During this



period, Lagos had witnessed significant LULC alterations due to rapid urbanization. Therefore, to predict the city's future land use/land cover of 2050, this period's LULC transition was considered. The study employed the Land Change Modeller (LCM) of TerrSet (Version 18.31) geospatial monitoring and modelling software to predict the city's future LULC. The modelling system is suitable for simulating land use/land cover changes, mainly when physical mapping is time-consuming and difficult. It utilises the combination of Markov chain and cellular automata models. The Markov chain model has been widely used in modelling changes in land use/land cover conditions due to its advantages for predicting land cover conditions through transition probabilities. However, the model lacks the ability to simulate the various alterations in spatial trends of land use/land cover classes. Therefore, the integrated CA-Markov model is considered in urban planning as an effective and robust simulation model that helps improve the efficiency of spatiotemporal land-use/land cover prediction. It computes transition matrixes based on the number of temporal changes among the different LULC classes. The CA-Markov helps simulate spatial variation by utilizing remotely sensed datasets and GIS techniques (Cunha, Santos, Silva, Bacani, & Pott, 2021). It is also a model that considers the suitability of changes in land use/land cover categories and the effect of natural, societal, and economic factors on LULC change dynamics (Sang, Zhang, Yang, Zhu, & Yun, 2011). In our present study, the modelling of the LULC changes was therefore conducted using the CA-Markov model due to the numerous advantages of the model for forecasting land use/land cover conditions. The CA-Markov model was trained in the land change modeler by combining the Markov chain processes and cellular automata filter functions. The simulation model utilised the transition probability matrix, transition areas matrix, and transition probability map of the simulated and validated period, i.e. the year 2020 to predict the changes in land use/land cover of Lagos in the forecasted period i.e. year 2050. The procedures involved for the land use/land cover simulation include; (i) analyzing the historical LULC data, (ii) modelling and validation of simulated LULC of 2020, and (iii) modelling the city's 2050 LULC pattern.

## **RESULTS AND DISCUSSION**

### **Historical LULC distribution and its changes**

The mapping of Lagos 'historical LULC pattern for the years 2000, 2010, and 2020 are illustrated in Figure 3, with the area statistics and its changes presented in Table 2. The result revealed significant growth in built-up areas from 23.43% in 2000 to 34.23% in 2020, increasing 10.8% over the last 20 years. The result shows that vegetation areas declined from 49.74% in 2000 to 45.29% in 2020. Water bodies declined from 22.90% in 2000 to 19.05% in 2020, while the bare soil increased from 3.93% in 2000 to 5.64% in 2020. The outcome signifies an increase and decrease in the different LULC patterns of Lagos, which can be attributed to the city's increased socio-economic activities that continuously alter land-use/land cover distribution (Auwalu, Wu, Ghali, Roknisadeh, & Akram Ahmed, 2021). Therefore, analyzing the historical LULC changes and forecasting future land-uses could help manage the city's built environment and drive policy interventions in areas needed.

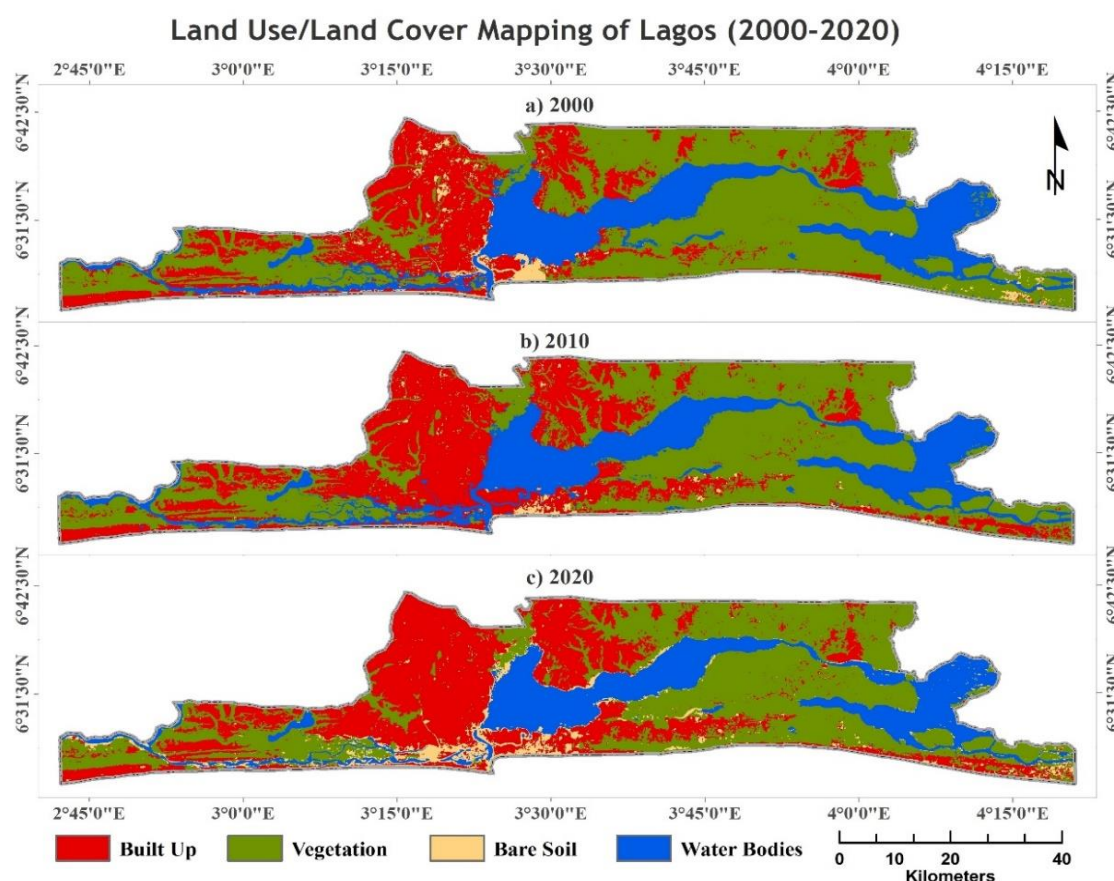

Figure 3: Land use/Land Cover Classification Mapping of Lagos in 2000, 2010, and 2020.

Table 2: LULC class distribution and its periodic changes.

LULC Categories	2000		2010		2020		Total Change in Area (2000-2010)		Total Change in Area (2010-2020)		Total Change in Area (2000-2020)	
	Area (km <sup>2</sup> )	Area (%)	Area (km <sup>2</sup> )	Area (%)	Area (km <sup>2</sup> )	Area (%)	(km <sup>2</sup> )	(%)	(km <sup>2</sup> )	(%)	(km <sup>2</sup> )	(%)
Built-Up	859.62	23.43	1112.84	30.33	1255.91	34.23	253.22	29.46	143.07	12.86	396.29	46.10
Vegetation	1824.93	49.74	1661.62	45.29	1507.21	41.08	-163.31	-8.95	-154.41	-9.29	-317.72	-17.41
Bare Soil	144.23	3.93	75.78	2.07	206.89	5.64	-68.45	-47.46	131.11	173.01	62.66	43.44
Waterbody	840.16	22.9	818.70	22.31	698.93	19.05	-21.46	-2.55	-119.77	-14.63	-141.23	-16.81

The study demonstrated the historical changes of the different LULC classes categorised into three different study periods, i.e., period one (2000-2010), period two (2010-2020), and period three (2000-2020). The analysis of the change detection result of the first period, i.e., 2000-2010, revealed an increase of 29.46% in Lagos city's built-up areas while the area of vegetation, water bodies, and bare soil declined by 8.95%, 2.55%, and 47.46%, respectively. During these ten years, the built-up area expanded rapidly by 253.22 km<sup>2</sup> while a significant decrease of 163.31 km<sup>2</sup>, 21.46 km<sup>2</sup>, and 68.45 km<sup>2</sup> was observed in vegetation, water bodies, and bare soil, respectively. These changes can be attributed to the city's socio-economic development that attracted a massive influx of people. In the second period between 2010 and 2020, the increase in the built-up areas was observed in Lagos city's central axis, precisely in urban areas around Ikeja, Mushin, Oshodi-

Isholo, and other adjoining areas. This period witnessed a lower growth magnitude in built-up areas having a decline of 16.6% compared with the earlier period between 2000 and 2010. Vegetation and water bodies also experienced a decreasing trend between 2010 and 2020, declining by 154.41 km<sup>2</sup> and 119.77km<sup>2</sup>, respectively. However, bare soil observed a significant increase of 173.01%, approximately 131.11 km<sup>2</sup>, during this second period. During the third period between 2000 and 2020, the built-up area expanded by 396.29 km<sup>2</sup>, i.e., 46.10%, while vegetation and water bodies decreased by 317.72 km<sup>2</sup> and 141.23 km<sup>2</sup>, respectively, signifying a decline in area of about 17.41% and 16.81%.

**Accuracy assessment of classification**

The study employed google earth images to evaluate the accuracy of classified land use/land cover maps. For this, the study compared the generated LULC maps of Lagos and the actual ground condition. It is an effective and reliable method of validating the accuracy of each LULC category. The result revealed an overall accuracy of 89.86% in 2000, 91.03% in 2010, and 95.12% in 2020. Also, it indicated a Kappa coefficient of approximately 0.85, 0.86, and 0.93 in 2000, 2010, and 2020. Anderson, Hardy, Roach, and Witmer (1976) specified 85% as the minimum level of accuracy for LULC class classification. In this study, the overall accuracies for all the periods under study were above 85%, indicating a reliable LULC classification (Congalton, 1991). Besides, a Kappa coefficient above 0.75 signifies good agreement between ground truth data and classified LULC categories.

**Simulation and validation of 2020 LULC**

The study compared the simulated land use/land cover map of 2020 with the satellite-derived LULC map of the study area in 2020, which served as the reference map representing the city’s actual ground condition. The automated 2020 LULC map comparison validated the simulation model for the CA-Markov.

**Table 3: Markov Transition probabilities for LULC change from 2010 to 2020.**

LULC Classes		2020			
		Built-up	Vegetation	Bare Soil	Water Bodies
2010	Built-up	0.9110	0.0186	0.0704	0.0000
	Vegetation	0.1744	0.7624	0.0609	0.0022
	Bare Soil	0.5396	0.0045	0.4559	0.0000
	Water Bodies	0.0841	0.0042	0.2638	0.6479

The validation information of the specified period (i.e., the year 2020) was used in the study to evaluate the certainty of the CA-Markov model for future LULC prediction. The result revealed four Kappa coefficients comprising a Kno value of 0.86, Klocation value of 0.81, KlocationStrata value of 0.82, and Kstandard value of 0.79. The analysis of the result shows that the individual kappa coefficients ‘values are all above 0.75, demonstrating a good and reliable simulation process (Landis & Koch, 1977). The validation result signifies that the simulation model along its composition is satisfactory for modelling future LULC changes. Thereafter, the model was employed to project the future land use/land cover of Lagos in 2050. The transitions in the various LULC classes during this period (i.e., (2010-2020) are presented in Table 3. The transitions indicate bare soil as the land cover class with the most significant probability of changing into built-up with a transition

probability of 0.5396, followed by vegetation with 0.1744 and then water bodies with 0.0841. Therefore, the study utilised the transition probability matrix between 2010 and 2020 to model the future land use/land cover of Lagos in 2050

### Predicted LULC pattern of 2050

The spatial distribution of LULC was mapped from 2020 to 2050. It relied on the result of the good validation process of the CA-Markov and utilised the simulation model for the prediction. The derived LULC maps of 2010 and 2020 were used to map Lagos 'future LULC distribution in 2050. The LULC map of 2020 was used as the base map for the CA Markov while incorporating the transition probability matrix for the period between 2010 and 2020 into the model. The modelling result of the LULC pattern of Lagos in 2050 is presented in Figure 4. Also, the comparison of the 2020 and 2050 LULC distribution obtained from the two LULC maps is presented in Table 4. It indicates both positive and negative changes in the different LULC classes. An analysis of the results revealed that in the next 29 years, Lagos built-up areas would increase from 1255.91 km<sup>2</sup> in 2020 to 1544.95 km<sup>2</sup> in 2050, indicating an increase of 289.04 km<sup>2</sup>. This increase will be likely attributed to the excessive use of natural land and the development of urban areas. The area comprising the city's bare soil is also expected to increase from 206.89 km<sup>2</sup> in 2020 to 464.51 km<sup>2</sup> in 2050. This indicates an increase of 257.62 km<sup>2</sup>. However, vegetation and water bodies showed a decreasing trend in the forecasted result. It indicated that the vegetation in Lagos would decline from 1507.21 km<sup>2</sup> in 2020 to 1192.45 km<sup>2</sup> in 2050, indicating a vegetation loss of 314.76 km<sup>2</sup>. The area covering the water bodies will also decline from 698.93 km<sup>2</sup> in 2020 to 467.03 km<sup>2</sup> in 2050, signifying a decline of 231.90 km<sup>2</sup>.

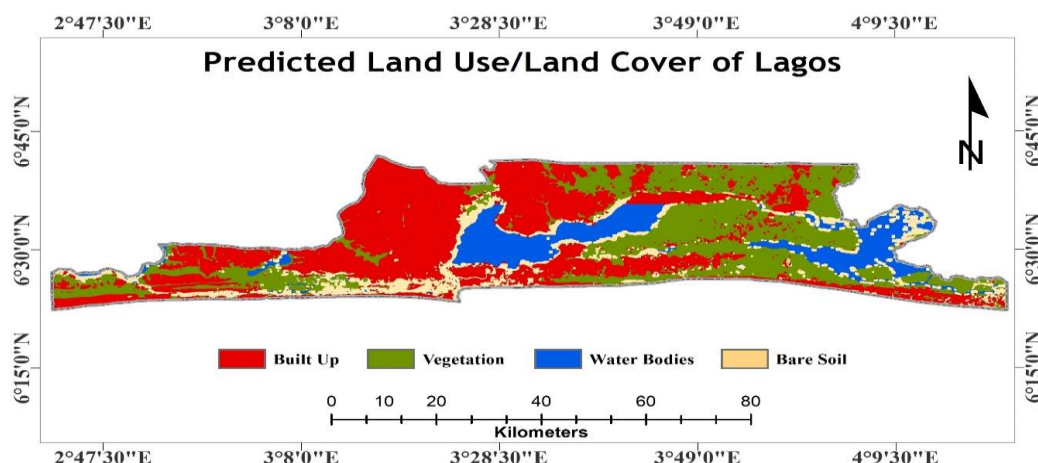

Figure 4: Predicted LULC Map of 2050

Table 4: Area of predicted LULC and its changes from 2020 to 2050.

LULC Classes	Area in 2020 (km <sup>2</sup> )	Area in 2050 (km <sup>2</sup> )	Total Change in Area (km <sup>2</sup> )	Total Change (%)
Built-up	1255.91	1544.95	289.04	23.01
Vegetation	1507.21	1192.45	-314.76	-20.88
Bare Soil	206.89	464.51	257.62	124.52
Water Bodies	698.93	467.03	-231.90	-33.18

In summary, the prediction of the 2050 LULC pattern of Lagos indicates that the city's built-up area and bare soil will expand by approximately 23.01% and 124.52%, respectively, while vegetation and water bodies will decline by approximately 20.88% and 33.18% over the next 29 years. The anticipated alterations in the land use/land cover pattern of the study area, i.e., Lagos, can mainly be attributed to the socio-economic development in various sectors of the city that comprise manufacturing, construction, transportation, and many others. The forecasted LULC will significantly help manage the environmental consequences of rapid urbanization in Lagos.

## CONCLUSIONS

The present study analysed the historical changes in land use/land cover of Lagos while aiming to model the city's future LULC over the next 29 years. Remotely sensed satellite images of the years 2010 and 2020 were employed to simulate the city's future LULC using an integrated CA-Markov model. The study validated the simulation model, and the outcome showed satisfactory kappa coefficients. The model was then used to project the future LULC pattern of Lagos in 2050. The results revealed that from 2020 to 2050, Lagos would witness a considerable increase in built-up areas and bare soil while a significant decline is expected in the city's vegetated land and water bodies. The integration of the CA-Markov model, coupled with geospatial technology, has demonstrated its capabilities for predicting future land-uses. The study result depicts the usefulness of the modelling technique as a tool for providing reliable LULC data on the magnitude of future LULC changes. However, this study was limited to assuming uniform historical transition probabilities in the LULC simulation model. It is, therefore, necessary for future studies to consider the unprecedented influences of various factors that include socio-economic data, climate, government policies, and many others. Incorporating these variables to model future LULC changes will undoubtedly lead to a more accurate and reliable LULC prediction.

## REFERENCES

- Abdulrahman, A. I., & Ameen, S. A. (2020). Predicting land use and land cover spatiotemporal changes utilizing CA-Markov model in Duhok district between 1999 and 2033. *Academic Journal of Nawroz University*, 9(4), 71-80. doi: 10.25007/ajnu.v9n4a892
- Abubakar, G., Wang, K., Shahtahamssebi, A., Xue, X., Belete, M., Abdallah, A., & Gan, M. (2020). Mapping Maize Fields by Using Multi-Temporal Sentinel-1A and Sentinel-2A Images in Makarfi, Northern Nigeria, Africa. *Sustainability*, 12, 2539. doi: 10.3390/su12062539
- Al-sharif, A. A. A., & Pradhan, B. (2014). Monitoring and predicting land-use change in Tripoli Metropolitan City using an integrated Markov chain and cellular automata models in GIS. *Arabian Journal of Geosciences*, 7(10), 4291-4301. doi: 10.1007/s12517-013-1119-7
- Alawamy, J., Balasundram, S., Hanif, A., & Teh, C. (2020). Detecting and Analyzing Land Use and Land Cover Changes in the Region of Al-Jabal Al-Akhdar, Libya Using Time-Series Landsat Data from 1985 to 2017. *Sustainability*, 12(11), 4490. doi: 10.3390/su12114490

- Anderson, J. R., Hardy, E. E., Roach, J. T., & Witmer, R. E. (1976). A land use and land cover classification system for use with remote sensor data Professional Paper.
- Aneesha Satya, B., Shashi, M., & Deva, P. (2020). Future land-use land cover scenario simulation using open source GIS for the city of Warangal, Telangana, India. *Applied Geomatics*, 12(3), 281-290. doi: 10.1007/s12518-020-00298-4
- Auwalu, F. K., Wu, Y., Ghali, A. A., Roknisadeh, H., & Akram Ahmed, N. A. (2021). Analyzing urban growth and land cover change scenario in Lagos, Nigeria using multi-temporal remote sensing data and GIS to mitigate flooding. *Geomatics, Natural Hazards and Risk*, 12(1), 631-652. doi: 10.1080/19475705.2021.1887940
- Ayele, G. T., Tebeje, A. K., Demissie, S. S., Belete, M. A., Jemberrie, M. A., Teshome, W. M., & Teshale, E. Z. (2018). Time Series Land Cover Mapping and Change Detection Analysis Using Geographic Information System and Remote Sensing, Northern Ethiopia. *Air, Soil and Water Research*, 11, 1-18. doi: 10.1177/1178622117751603
- Butt, A., Shabbir, R., Ahmad, S. S., & Aziz, N. (2015). Land-use change mapping and analysis using Remote Sensing and GIS: A case study of Simly watershed, Islamabad, Pakistan. *The Egyptian Journal of Remote Sensing and Space Science*, 18(2), 251-259. doi: 10.1016/j.ejrs.2015.07.003
- Cheruto, M., Kauti, M., Kisangau, P., & Kariuki, P. (2016). Assessment of Land Use and Land Cover Change Using GIS and Remote Sensing Techniques: A Case Study of Makueni County, Kenya. *Journal of Remote Sensing & GIS*, 05. doi: 10.4172/2469-4134.1000175
- Congalton, R. G. (1991). A review of assessing the accuracy of classifications of remotely sensed data. *Remote Sensing of Environment*, 37(1), 35-46. doi: 10.1016/0034-4257(91)90048-B
- Coppin, P., Jonckheere, I., Nackaerts, K., Muys, B., & Lambin, E. (2010). Digital change detection methods in ecosystem monitoring: A review. *International Journal of Remote Sensing*, 25(9), 1565-1596. doi: 10.1080/0143116031000101675
- Cromley, R. G., & Hanink, D. M. (1999). Coupling land use allocation models with raster GIS. *Journal of Geographical Systems*, 1(2), 137-153. doi: 10.1007/s101090050009
- Cunha, E. R. d., Santos, C. A. G., Silva, R. M. d., Bacani, V. M., & Pott, A. (2021). Future scenarios based on a CA-Markov land use and land cover simulation model for a tropical humid basin in the Cerrado/Atlantic forest ecotone of Brazil. *Land Use Policy*, 101, 105141. doi: 10.1016/j.landusepol.2020.105141
- Du, Y., Lin, Y., Wang, J., Kong, X., Jin, Z., & Zhao, X. (2019). Estimation and Prediction of Vegetation Coverage in Yancheng National Nature Reserve. Paper presented at the IGARSS 2019 - 2019 IEEE International Geoscience and Remote Sensing Symposium.
- Foody, G. M. (2004). Thematic map comparison: evaluating the statistical significance of differences in classification accuracy. *Photogrammetric Engineering & Remote Sensing*, 70(5), 627-633.
- Ghosh, P., Mukhopadhyay, A., Chanda, A., Mondal, P., Akhand, A., Mukherjee, S., . . . Hazra, S. (2017). Application of Cellular automata and Markov-chain model in geospatial environmental modeling- A review. *Remote Sensing Applications: Society and Environment*, 5, 64-77. doi: 10.1016/j.rsase.2017.01.005
- Gidey, E., Dikinya, O., Sebego, R., Segosebe, E., & Zenebe, A. (2017). Cellular automata and Markov Chain (CA\_Markov) model-based predictions of future land use and land cover scenarios (2015–2033) in Raya, northern Ethiopia. *Modeling Earth Systems and Environment*, 3(4), 1245-1262. doi: 10.1007/s40808-017-0397-6

- Gogoi, P. P., Vinoj, V., Swain, D., Roberts, G., Dash, J., & Tripathy, S. (2019). Land use and land cover change effect on surface temperature over Eastern India. *Scientific Reports*, 9(1), 8859. doi: 10.1038/s41598-019-45213-z
- Gong, W., Yuan, L., Fan, W., & Stott, P. (2015). Analysis and simulation of land use spatial pattern in Harbin prefecture based on trajectories and cellular automata-Markov modelling. *International Journal of Applied Earth Observation and Geoinformation*, 34, 207-216. doi: 10.1016/j.jag.2014.07.005
- Halmy, M. W. A., Gessler, P. E., Hicke, J. A., & Salem, B. B. (2015). Land use/land cover change detection and prediction in the north-western coastal desert of Egypt using Markov-CA. *Applied Geography*, 63, 101-112. doi: 10.1016/j.apgeog.2015.06.015
- Haque, M. I., & Basak, R. (2017). Land cover change detection using GIS and remote sensing techniques: A spatio-temporal study on Tanguar Haor, Sunamganj, Bangladesh. *The Egyptian Journal of Remote Sensing and Space Science*, 20(2), 251-263. doi: 10.1016/j.ejrs.2016.12.003
- Jimoh, R. A., Bankole, O. M., Ahmed, K., Christopher, O. A., Adeniji, M. A., Ebhodaghe, J., & Ezima, E. A. (2018). Use of geophysical logs in hydrogeological studies and borehole designs: case study of Apapa coastal area, Lagos, Nigeria. *Applied Water Science*, 8(7), 191. doi: 10.1007/s13201-018-0804-9
- Koko, A. F., Yue, W., Abubakar, G. A., Hamed, R., & Alabsi, A. A. N. (2020). Monitoring and Predicting Spatio-Temporal Land Use/Land Cover Changes in Zaria City, Nigeria, through an Integrated Cellular Automata and Markov Chain Model (CA-Markov). *Sustainability*, 12(24), 10452. doi: 10.3390/su122410452
- Lagos State Government. (2020). About Lagos. Retrieved 20th May, 2020, from <https://lagosstate.gov.ng/about-lagos/>
- Landis, J. R., & Koch, G. G. (1977). The measurement of observer agreement for categorical data. *Biometrics*, 33(1), 159-174.
- Liping, C., Yujun, S., & Saeed, S. (2018). Monitoring and predicting land use and land cover changes using remote sensing and GIS techniques—A case study of a hilly area, Jiangle, China. *PLOS ONE*, 13(7), e0200493. doi: 10.1371/journal.pone.0200493
- Population Stat. (2020). World Statistical Data: Lagos, Nigeria Population. Retrieved 5th January, 2021, from <https://populationstat.com/nigeria/lagos>
- Rouchier, J., Bousquet, F., Requier-Desjardins, M., & Antona, M. (2001). A multi-agent model for describing transhumance in North Cameroon: Comparison of different rationality to develop a routine. *Journal of Economic Dynamics and Control*, 25(3), 527-559. doi: 10.1016/S0165-1889(00)00035-X
- Rwanga, S., & Ndambuki, J. (2017). Accuracy Assessment of Land Use/Land Cover Classification Using Remote Sensing and GIS. *International Journal of Geosciences*, 8(4), 611-622. doi: 10.4236/ijg.2017.84033
- Sahebgharani, A. (2016). Multi-objective land-use optimization through parallel particle swarm algorithm: Case study Baboldasht district of Isfahan, Iran. *J. Urban Environ. Eng*, 10, 42-49. doi: 10.4090/juee.2016.v10n1.042049
- Sang, L., Zhang, C., Yang, J., Zhu, D., & Yun, W. (2011). Simulation of land use spatial pattern of towns and villages based on CA-Markov model. *Mathematical and Computer Modelling*, 54(3), 938-943. doi: 10.1016/j.mcm.2010.11.019

- Shi, G., Ye, P., Ding, L., Quinones, A., Li, Y., & Jiang, N. (2019). Spatio-Temporal Patterns of Land Use and Cover Change from 1990 to 2010: A Case Study of Jiangsu Province, China. *International Journal of Environmental Research and Public Health*, 16(6). doi: 10.3390/ijerph16060907
- Song, W., & Deng, X. (2017). Land-use/land-cover change and ecosystem service provision in China. *Science of The Total Environment*, 576, 705-719. doi: 10.1016/j.scitotenv.2016.07.078
- Veldkamp, A., & Fresco, L. O. (1996). CLUE-CR: An integrated multi-scale model to simulate land-use change scenarios in Costa Rica. *Ecological Modelling*, 91(1), 231-248. doi: 10.1016/0304-3800(95)00158-1
- Wang, J., & Maduako, I. N. (2018). Spatio-temporal urban growth dynamics of Lagos Metropolitan Region of Nigeria based on Hybrid methods for LULC modeling and prediction. *European Journal of Remote Sensing*, 51(1), 251-265. doi: 10.1080/22797254.2017.1419831
- Xu, X., Xie, Y., Qi, K., Luo, Z., & Wang, X. (2018). Detecting the response of bird communities and biodiversity to habitat loss and fragmentation due to urbanization. *Science of The Total Environment*, 624, 1561-1576. doi: 10.1016/j.scitotenv.2017.12.143
- Yang, Y., Yang, X., Li, E., & Huang, W. (2021). Transitions in land use and cover and their dynamic mechanisms in the Haihe River Basin, China. *Environmental Earth Sciences*, 80(2), 50. doi: 10.1007/s12665-020-09291-x
- Zheng, H. W., Shen, G. Q., Wang, H., & Hong, J. (2015). Simulating land-use change in urban renewal areas: A case study in Hong Kong. *Habitat International*, 46, 23-34. doi: 10.1016/j.habitatint.2014.10.008
- Zhong, S., Qian, Y., Zhao, C., Leung, L., Wang, H., Yang, B., & Liu, D. (2017). Urbanization-induced urban heat island and aerosol effects on climate extremes in the Yangtze River Delta region of China. *Atmospheric Chemistry and Physics*, 17(8), 5439-5457. doi: 10.5194/acp-17-5439-2017





# MODELLING OPTIMAL UNCONFINED COMPRESSIVE STRENGTH OF GEOTEXTILE REINFORCED SOIL FOR FLEXIBLE FOUNDATION CONSTRUCTION

Daniel E. Aju<sup>1</sup> and Kennedy C. Onyelowe<sup>2</sup>

<sup>1</sup>*Department of Work, Cross River Institute of Technology and Management, Ugep, Cross River State, Nigeria*

<sup>2</sup>*Department of Civil Engineering, College of Engineering and Engineering Technology, Michael Okpara University of Agriculture, Umudike, Nigeria*

Extreme vertex design (EVD) provides an efficient approach to mixture experiment design whereby the factor level possess multiple dependencies are expressed through component constraints formulation. EVD was deployed for the modeling UCS of a geogrid reinforced problematic soil aimed at checking the validity in subgrade construction. Geogrids are geosynthetic materials, which possess an open mesh-like structure and are mostly used for soil stabilization. Geogrids present permeable layer to support the soil and foundation by improving the stiffness characteristics. It is cheap compared to other construction materials and possesses unique light weight properties with greater strength improvement on the soil layer when used. Minitab 18 and Design Expert statistical software were utilized for the mixture design experiment computation. To fully explore the constrained region of the simplex, I-optimal designs with a special cubic design model were utilized to formulate the mixture component ratios at ten experimental runs. I-optimality and D-optimality of 0.39093 and 1747.474, respectively, were obtained with G-efficiency of 64.8%. The laboratory responses were taken together with the mixture ingredients as the system database for the model development. Statistical influence and diagnostics tests carried out on the generated EVD model indicated a good correlation with the experimental results. Graphical and numerical optimizations were incorporated using desirability functions that ranged from 0 to 1, which helped to arrive at the optimal combination of the mixture components. 0.2% of geogrid, 9.8% of water, and 90 % of soil yielded the optimal solution with a response of 41.270kN/m<sup>2</sup> and a desirability score of 1.0. Model simulation was further carried out to test the model's applicability in subgrade construction with the results compared with the actual results using student's t-test and analysis of variance. The statistical results showed  $p\text{-value} > 0.05$  which indicates good correlation.

Keywords: constrained simplex method, design expert, extreme vertices, geogrid, soil, unconfined compressive strength

<sup>1</sup> [ajudaniel85@gmail.com](mailto:ajudaniel85@gmail.com); [daniel\\_aju@critm.edu.ng](mailto:daniel_aju@critm.edu.ng)

<sup>2</sup> [konyelowe@mouau.edu.ng](mailto:konyelowe@mouau.edu.ng); [kennedychibuzor@kiu.ac.ug](mailto:kennedychibuzor@kiu.ac.ug)

## INTRODUCTION

Geosynthetics are non-natural materials often used to improve soil's mechanical properties. They are obtained from petro-chemical polymer-based plastics (polymeric materials) which are inert biologically and would not decompose due to the actions of fungal, bacteria, and microorganisms (B. Indraratna et al. 2011). However, their chemical properties vary as most are totally inert while some are affected by sunlight and petrochemicals. They are incorporated with soil to achieve confinement, separation, and distribution of loads such as reinforcement for water pressure control and prevent soil movement while allowing water pass through the material. It can also be effectively utilized to prevent or reduce base coarse aggregates horizontal deformation and to resist asphalt reflective cracking (H. A. Alawaji, 2001). Construction of flexible road pavement with expansive subgrade soil most times requires higher thickness for constituting cross-section materials to safely carry the intending traffic loads without excessive and differential settlement of the subgrade (Salahudeen et al. 2014). Moreover, the flexible pavement could also deteriorate rapidly due to aggregated cross-section layers sinking into the expansive subgrade under traffic loads with increased moisture content. However, the introduction of geosynthetic layer between the problematic clayey subgrade materials and the aggregate layer (base and sub-base) can prevent the dreadful intermixing of the soft subgrade with the sub-base and base layer which results in road failure (I. Al.Qadi et al. 2018). The incorporation of geosynthetic materials can also provide significant gains in terms of thickness reduction of the pavement cross-section layers due to improved strength performance. Geogrid is a special type of geosynthetic material produced by stretching and extrusion of a high polymeric molecule (polyester, propylene or high density polyethylene (HDPE)). It possesses a number of apertures which are uniformly distributed between the transverse and longitudinal sections. Through the apertures, there is direct contact and bonding between the sheets of the geosynthetic materials and the soil particle (Bounsanti et al. 2012; A. Demir et al. 2012). With the use of weak soil in pavement construction, there is need to improve the unconfined compressive strength of the soil in order be able to withstand the axial traffic load. One of those methods includes the use of geogrids to reinforce the soil. However, the optimization of the utilization of these stabilization or soil reinforcement materials and the strength properties has become very important. Hence, the primary focus of this work was to apply the technique of extreme vertex design of experimental mixtures to optimize the UCS of the geogrid reinforced soil used as subgrade material. Extreme vertex design (EVD) method is a mixture design technique, which occupies a sub-portion or smaller space within the simplex. The technique is essential when the design factor space selected is not L-simplex design. This limitation is imposed by both lower and upper bound constraints in the factor levels when there is a high level of interdependencies between the mixture components (R. A. McLean and V. L. Anderson, 2012). The major objective of EVD method is to choose design points that appropriately cover the design space; this occurs as a result of additional constraints imposition of upper and lower boundary conditions on the mixture components which causes the design points occupying some portion of the simplex known as the constrained region. Extreme vertex design technique permits the imposition of additional boundary limits on the mixture component values by specifying upper bounds on

components and defining linear constraints for blends. The goal of using an extreme vertex design is to choose design points that adequately cover the design space (Damiri et al. 2016).

For q-component mixtures where the *i*th component proportion present in the mixture by  $x_i$ , the factor space takes the shape of a regular (q-1) dimensional simplex due to the sum of one constraint presented in Eqn. 1. EVD method is flexible enough to deal with the imposition of additional constraints on the mixture components due to multiple dependencies between them. The lower and upper limit is denoted by  $L_i$  and  $U_i$  respectively, as shown in Eqn. 2 and the sum of the mixture component ratios must be unity (J. A. Cornell, 2011).

$$\sum_{i=1}^q x_i = 1, \quad i = 1, 2, 3 \dots q \quad 0 \leq x_i \leq 1 \tag{1}$$

$$0 \leq L_i \leq x_i \leq U_i \leq 1 \tag{2}$$

The mixture experiments objective is to develop mathematical model adequate where the factor levels  $(x_1, x_2, x_3, \dots, x_q)$  relates the desired response parameters. Commonly used Scheffe's method for data fitting which is expressed in Eqn. 3 for quadratic polynomial function (J. A. Cornell, 2011).

$$E(Y) = \sum_{i=1}^q \beta_i x_i + \sum_{i < j} \beta_{ij} x_i x_j \tag{3}$$

And this is represented in matrix form as shown in Eqn. 4.

$$Y = X\beta + \varepsilon \tag{4}$$

Where  $X$  is  $n \times k (\cong q)$  matrix and  $k$  is the number of model terms;  $Y$  is  $n \times 1$  vector for the response parameter observations;  $\varepsilon$  is  $n \times 1$  vector for the error function; and  $\beta$  is a  $k \times 1$  vector for the predicted parameters (H. Scheffe, 1958; D. Jiang-Tong et al. 1999).

The error properties were assumed to possess the property expressed in Eqn. 5

$$E(\varepsilon) = 0, \quad E(\varepsilon\varepsilon') = \sigma^2 I_n \tag{5}$$

Where  $\sigma^2$  = the variance of the error function;  $I_n$  is an identity matrix.

The least square estimator for the predicted variables  $\beta$  is presented in Eqn. 6.

$$b = (X'X)^{-1} X'Y \tag{6}$$

The variance covariance matrix of the least squares estimator solution (b) is further expressed in Eqn. 7.

$$Var(b) = (X'X)^{-1}\sigma^2 \quad (7)$$

## MATERIAL AND METHODS

### Materials preparation

Expansive soil was collected at Edem Ekpenyong Street Anantigha, Calabar South Local Government Area of Cross River State, Nigeria. The geogrid (as presented in Fig. 1) was also obtained from Sermatech Construction Company in Calabar, Cross River State, Nigeria. Geogrids are spaced grid or open mesh-like synthetic materials of constituting polymers cemented integrally as shown in Fig. 1. They have mechanical strength characteristics than common geosynthetic materials and can only stretch to limit about 2% - 5% under loading condition (Guimaraes et al. 2017; Wang et al. 2010). The properties of the geogrid material used are shown in Table 1.



Fig. 1: Geogrid material

**Table 1: Test geogrid properties**

Aperture Size of Mesh (mm)	10 x 10
Shape of Aperture (mm)	Square
Tensile Strength (kN/m)	12.5
Color	Black
Structure	Bi-directional
Elongation at maximum load (%)	20.5
Unit Weight (N/m <sup>2</sup> )	7.35
Thickness of Sheet (mm)	4
Raw Material	Polypropylene

### Experimental Methods

The experimental programs for the investigative study were carried out upon the guiding requirements stipulated in BS 1924 (1990) and BS 1377 (1990) for the problematic clayey soil mechanical properties improvement using geosynthetic materials. Classification and general engineering properties derivation of the test soil were first achieved through specific gravity test, consistency limit, compaction test, sieve analysis, and unconfined compressive strength (UCS) test. This mixture experiment problem, which involves three component materials, namely; geogrid, water, and clayey soil, and because of the component constraint imposition at the

lower and upper boundary limits, the simplex is consequently constrained whereby the experimental points are situated at the vertices, interior and edges of the constrained region instead of the whole of the simplex (Aslam et al. 2020). Using I-optimal design computation with quadratic model design, the constrained experimental portion was adequately explored to generate the mixture components ratios and the number of experimental runs required. UCS tests were carried out in respect to the formulated ingredients proportions and the corresponding responses derived were utilized for the mechanical behavior modelling of the soil-geogrid blend. Statistical influences and diagnostic tests were carried out to validate the developed EVD model. Furthermore, graphical and numerical optimization is conducted using desirability function computation to maximize the output variable criteria with respect to the factor levels. The optimal combinations of the soil-geogrid blend for maximum mechanical response were determined in this process followed by simulation of the EVD model (W. Wangkamanon et al. 2018). The research program flowchart is presented in Fig. 2.

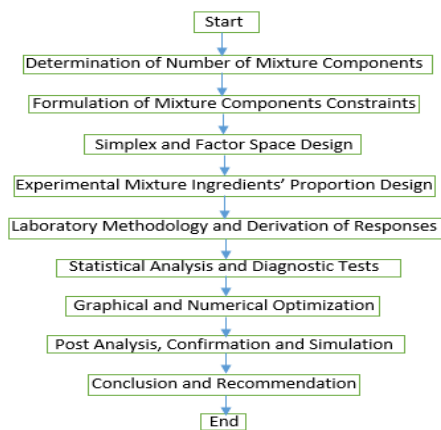

Fig. 2: Program flowchart

### Unconfined Compressive Strength

The unconfined compressive strength (UCS) is the maximum axial compressive stress that a right-cylindrical sample of material can withstand under unconfined conditions. The purpose of this laboratory is to determine the unconfined compressive strength of a cohesive soil sample. In this test, a cylinder of soil without lateral support is tested to failure in simple compression at a constant rate of stream. The compressive load per unit area required to fail the specimen is called unconfirmed compressive strength of the soil in accordance with BS1377 (1990) with a setup presented in Fig. 3.



Fig. 3: Unconfined compressive strength experimental setup

### Formulation of geotextile soil specimen mix proportions

The determination of the actual proportion of the mixture ingredients to be mixed for each particular experimental run and the total number of experimental runs were carried out here. The effective ratios obtained here form the fundamental base for the EVD model development to derive the optimal combination ratio for the soil-geogrid blend and achieve improvement in the problematic clayey soil engineering properties for flexible pavement construction. The mixture formulation computation was carried out with Design Expert 11 and Minitab 18 statistical software (Design Expert 11, 2018; Minitab 18, 2018).

### Formulation of constraints

The mixture components are imposed with lower and upper bounds established through the properties of the ingredient materials which constitute the experimental soil-geogrid blend. In most cases, practical and environmental, economic, or physical considerations impose most of these boundary conditions. For the three-component mixture investigated in this research study, constituting of geogrid, water and problematic clayey soil to enhance its mechanical properties. From the relevant literatures (Zhou et al. 2012), the component constraints were formulated using single component constraints (SCC) are shown in Table 2.

**Table 2: Design constraints**

Mixture Coding:	Actual	
Low	Constraint	High
0.001	A:geogrid	0.002
0.098	B:water	0.150
0.848	C:soil	0.900
	A+B+C	1.000

### Design of simplex and factor space

The developed constraints, which defined the upper and lower limits of the single component constraints imposed on the factor levels, cause the factor space to take a hyper-polyhedron simplex shape. The feasible experimental region within the simplex, termed the constrained space, is then obtained through the component constraints evaluation (Zhou et al. 2012). The degree of freedom evaluation is also conducted through design matrix computation for the design mixture using a quadratic model with U\_pseudo mixture component coding as presented in Table 3. A minimum of 3 lacks of fit degrees of freedom (df) is required. This ensures a valid lack of fit test. Less df will result in a test that will not detect a lack of fit (Design Expert 11, 2018; Minitab 18, 2018).

**Table 3: Design matrix evaluation for mixture quadratic model 3 factors: A, B, C with U\_Pseudo Mixture**

Degrees of Freedom for Evaluation	
Model	5
Residuals	4
<i>Lack of Fit</i>	3
<i>Pure Error</i>	1
Corr Total	9

The software further developed the contour plot of the 3- component simplex shown in Fig. 4, which diagrammatically displays the actual experimental points positioned within the constrained region. The information matrix measures showing the space type, leverages, and build types. Ten (10) runs were generated to improve on the optimality or efficiency of the model operation. Lack of fit was recorded on axialCB while the replicate point is situated at the center space of the feasible design space. The model build type was thus situated at the vertex and center-edge space type. Average leverage of 0.6 was calculated; this in effect raises concern for more design points to be located on these spaces of the simplex to reduce the lack of fit effect on the entire experimental space (Lawson and Erjavec, 2001).

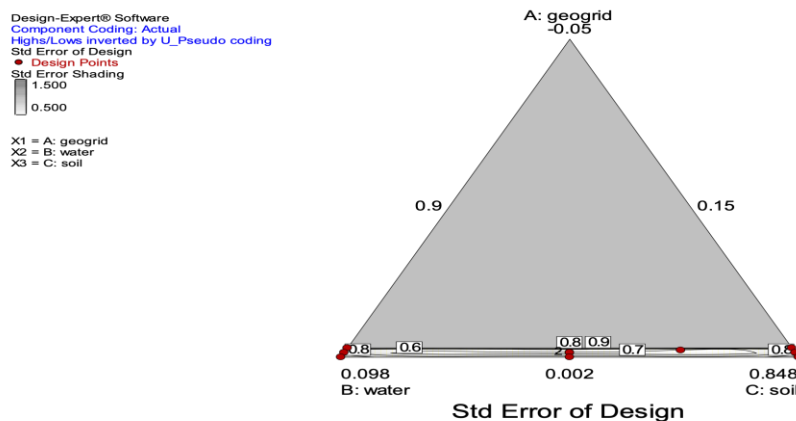

Fig. 4: Factor space simplex of a 3- component mixture experiment of water, soil, and geogrids.

The relevant data statistics for the design of experiments, multicollinearity design, scaled D-optimality, and I-optimal design computations were carried out using design expert software. D-optimality produces a design that best estimates the effects of the factors, which is particularly suited for screening studies. The algorithm picks points that minimize the volume of the confidence ellipsoid for the coefficients. I.e., it minimizes the determinant of the inverse matrix  $X'X$ , while I-optimal designs, also known as IV (integrated variance), provides a minimum average estimation of the variance across the experimental regions (U. Syafitri et al. 2015).

### Design of experimental mix proportions

The number of experimental runs and the ingredients proportions were derived from the information matrix. Ten runs of experiments were derived in the process based on the imposed component constraints. The mixes and runs for the 3- component multi-constraints experimental design guide the preparation of specimens to be tested in the laboratory to achieve the responses (Xue et al. 2014; Alaneme et al. 2020).

## RESULT DISCUSSION AND ANALYSIS

### Test materials characterization

The general classification and engineering behavior of the soil is presented in Table 4. The results indicate that it possesses high plasticity and swelling potential; it is also poorly graded and exhibits expansive properties of soft materials. The

classification by AASHTO (1993) and USCS (ASTM, 1992) produced A-7 and CH, respectively, which indicates an unsuitable soil for engineering work with low CBR of 5 %, MDD of 1.28 Mg/m<sup>3</sup> and OMC of 17 %. The studied soil has a specific gravity of 2.38 and from the grain size distribution of the unaltered soil, 38.24 % were passed through BS No. 200 sieve (75 µm aperture) (see Fig. 5). Plastic limit, liquid limit and plasticity index results of 20.53%, 54.23%, and 33.7. According to Federal Ministry of Works and Housing specification (FMWH, 1997), the soils not suitable for subgrade materials possess liquid limit and plasticity index values = < 30% and = < 13% respectively which implies that samples fall outside the required specification. However, a stabilization process is required to improve its properties to make it suitable for civil works (Bello et al. 2007).

**Table 4: Basic properties of the test soil**

Percentage Passing BS No. 200 Sieve (75 µm aperture)	38.24
Natural Moisture Content (%)	36.45
Dry Unit Weight ( $\gamma_d$ ) (kN/m <sup>3</sup> )	17.69
Specific Gravity	2.38
Liquid Limit (%)	54.23
Plastic Limit (%)	20.53
Plasticity Index (%)	33.7
OMC (%)	17
MDD (g/cm <sup>3</sup> )	1.28
AASHTO	A-7
USCS	CH
CBR (%)	5
Unconfined Compressive Strength (UCS) ( kN/m <sup>2</sup> )	12.287

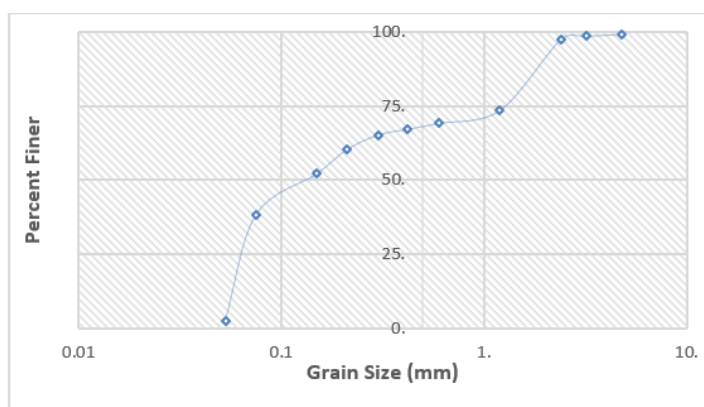

Fig. 5: Particle Size Distribution Graph



### Unconfined Compressive Strength (UCS) test results

The experimental parameters utilized for the Unconfined Compressive Strength (UCS) test of the soil-geogrid blend with a proven ring factor of 0.0009kN are according to required standard (BS1377, 1990). The strain reading, corrected area, and stress values were then derived for each experimental run. The soils were further blended with geogrid at varying ratios according to the mixture ratio formulated and the results computations carried out with the derived dimension and cross-sectional area of the mold are presented below (K. C. Onyelowe et al. 2019a. 2019b);

From the computed values, the maximum result of 37.97 kN/m<sup>2</sup> was obtained for test (run 4) while the minimum of 13.312 kN/m<sup>2</sup> was obtained for test (run 1), which indicates a significant improvement on the soil's compressive strength properties in line with the federal Ministry of Works specification for subgrade materials. The result summary using percentage frequency statistics computation shows that 0.2% of geogrid, 9.8% of water and 90% of soil by weight produced the maximum response of 37.97kN/m<sup>2</sup> for UCS target variable while 0.2% of geogrid, 15% of water and 84.8% of soil by weight produced the minimum response 13.312 kN/m<sup>2</sup> for UCS (Zhou et al. 2012). The stress strain plot is presented in Fig. 6

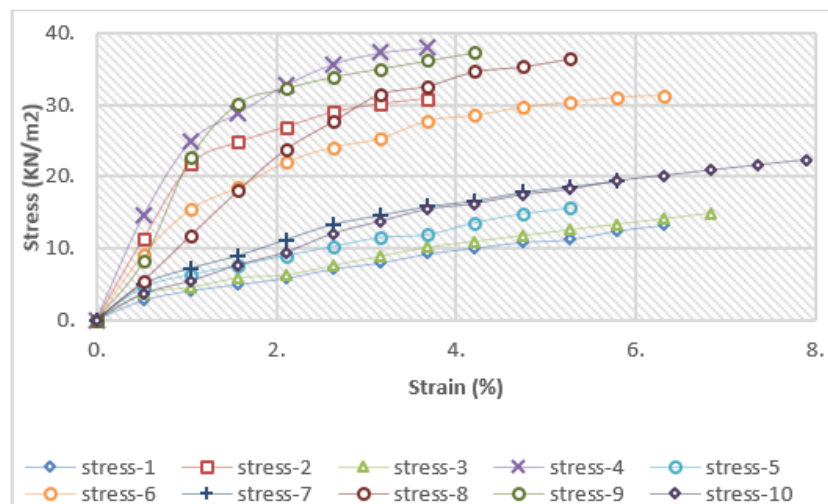

Fig. 6: UCS Stress vs. strain Plot

### Model development and validation

For the analysis after experimental reports were obtained, the appropriate transformation which is quadratic (square root) and the response ranges from 5.13527 to 18.9128 with a ratio of max to min of 3.683 for CBR response (McLean and Anderson, 1966; Pinho-Lopes et al. 2018). Scheffe's models with intercepts built into the model coefficients are utilized for this mixture design. The transformation is required when the residual (error) is a function of the response magnitude (predicted results) and the transformation would be impactful unless the maximum to minimum ratio of the response parameter is very large (K. C. Onyelowe et al. 2019a; K. C. Onyelowe et al. 2019b, Alaneme et al. 2020). The fits summary, diagnostic tests, graphical and numerical optimization were carried out to determine the optimal combination proportion of the soil-geogrid blend to maximize the mechanical strength response. Post analysis, confirmation coefficient tables, and EVD model simulation were then executed to validate the model results using Design Expert 11 (2018) and Minitab 18 (2018) software.

### Fit summary for UCS Response

The model fit summary statistics results indicated preference for quadratic model for CBR response with R-squared, predicted, adjusted and R-squared of 0.8367, 0.6417 and 0.79 respectively. The lack of fit test results presented a sum of squares of 1.09, a mean square of 0.18, and lack of fit p-value (Prob > F) of 0.8010.

### Coefficient estimates and model equations for UCS

The estimates of components 'coefficient, standard error, degrees of freedom, variance inflation factor (VIF), and final equation in terms of L\_pseudo component computation results are presented in Tables 5&6. VIF measures the extent to which the variance of the coefficient estimate (predictor) is inflated by a lack of orthogonality in the design points. If the factor is orthogonal with respect to all other factors in the model, then VIF = 1 (Pinho-Lopes et al. 2018; Bello et al. 2007).

**Table 5: Final Equation in Terms of U\_Pseudo Components**

	*A	*B	*C	*AB	*AC	*BC
Sqrt(UCS) =	621.935	64.085	11.82484	-663.296	6315.46	3.10192

The equation in terms of coded factors can be used to make predictions about the response for given levels of each factor. By default, the high levels of the factors are coded as +1 and the low levels of the factors are coded as -1. The coded equation is useful for identifying the relative impact of the factors by comparing the factor coefficients (Design Expert 11, 2018; Minitab 18, 2018).

**Table 6: Final equation in terms of U\_Pseudo components**

	*Geogrid	*Water	*Soils	Geogrid*Water	Geogrid*Soil	Water*Soil
Sqrt(UCS) =	2.36E+05	-615.29836	-3.1977	-2.45E+05	-2.35E+05	777.336

The equation in terms of actual factors can be used to make predictions about the response for given levels of each factor. Here, the levels should be specified in the original units for each factor. This equation should not be used to determine the relative impact of each factor because the coefficients are scaled to accommodate the units of each factor and the intercept is not at the center of the design space (J. A. Cornell, 2011).

### Predicted vs. actual

This diagnostic plot shows the predicted EVD model response values on the y-axis against the actual values on the x-axis. This plot could also help to determine the value, or a group of values that are not estimated easily by the EVD model in terms of accuracy as presented in Fig. 7. The result deduced from the plotted results indicates a strong correlation between the experimental and the model predicted values with the plotted datasets ranging from about 3.5-6.5 (Pinho-Lopes et al. 2018; Bello et al. 2007).

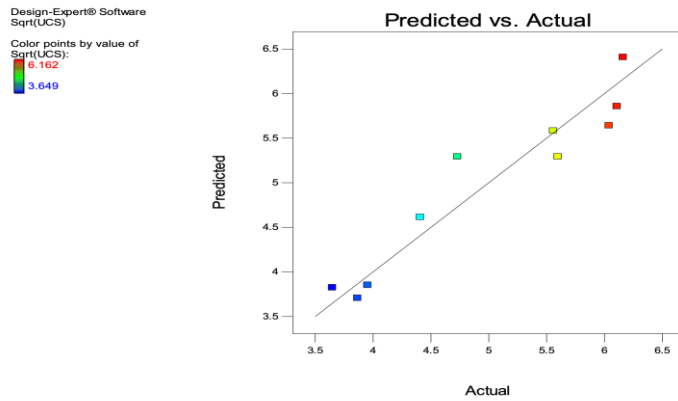

Fig. 7: Predicted vs. Actual UCS response

### Optimization overview

Numerical optimization uses the model to search the factor space for the best trade-offs to achieve multiple goals. The optimization module searches for a combination of factor levels that simultaneously satisfy the criteria placed on each of the responses and factors. The goals that apply to both responses and factors were set to be in the range for the factors and maximize for the response where the lower limit is the lowest acceptable outcome and the upper limit is the desired best result.

In the desirability function computation, the solution with the highest score is preferentially taken as the optimal solution. A desirability criterion score of 1.0 and optimal ratio 0.002:0.098:0.9 for the fraction of geogrid, water and soil, respectively (J. Schwartz et al. 1981; Design Expert 11, 2018; Minitab 18, 2018).

### Optimization ramps and bar graph

The numerical optimization ramps show the optimal solution graphical view with the optimal predictor parameter factor settings in red and the optimal response parameter factor in blue. This tool helps to make the required selection of the optimal solution in a graphical view presentation as shown in Fig. 11. Desirability value of 1.0 was calculated for the mixture component variables and the response variables, which indicate a robust model prediction of the mechanical behavior of soil-geogrid blend (Lawson and Erjavec, 2001; U. Syafitri et al. 2015; Ding et al. 1999).

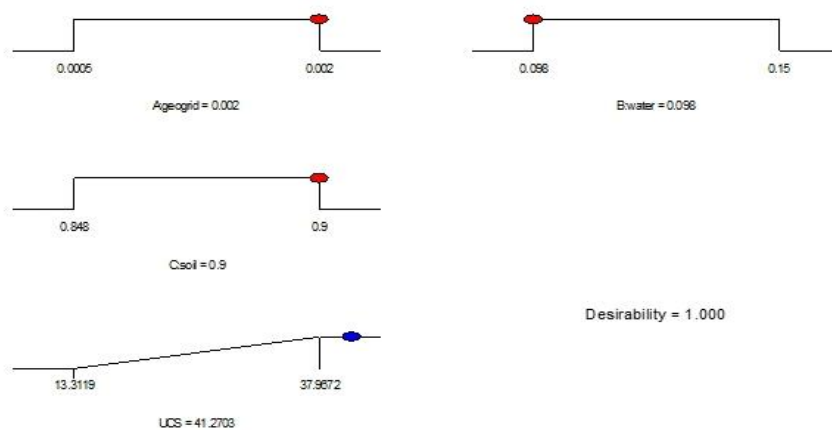

Fig. 8: Optimization Ramps

## Optimization contour plot

The contour plot is an important tool for the visualization of the feasible experimental region's functional points in the iteration solution of mixture optimization (Design Expert 11, 2018; K. C. Onyelowo et al. 2019a). The contour plot for the optimal solution for the design points for UCS are ranging from 13.3119 to 37.9672 and the desirability points from 0 to 1. It is a graphical tool for the representation of 3-D surfaces by contour plotting in terms of constant slices in 2-D form as shown in Fig. 12.

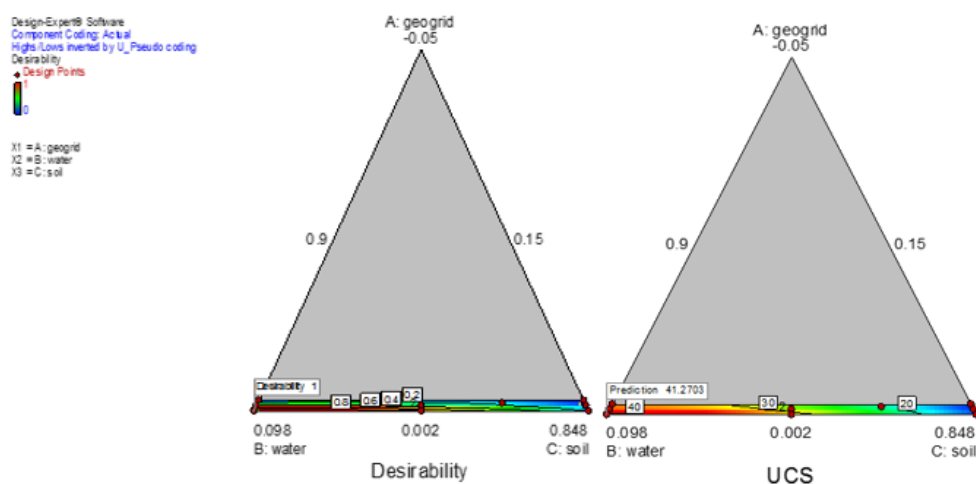

Fig. 12: Contour Plots for the Optimal Solution

## CONCLUSION

In this research study, geogrids were utilized for engineering properties and modification of soil properties for civil engineering construction purposes. The research process involved the general engineering characterization of the test soil through experimental and laboratory processes to obtain the test soil's general engineering behavior and classification. The results obtained indicated high swelling potential and plasticity behavior with AASHTO classification of A-7 and unsuitable for engineering work. From the EVD optimization;

1. I-optimal design was utilized to explore the constrained factor space for the derivation of the run of experiments and mixture proportions formulation at the edges, center, interior, and vertex of the simplex. The mixture of experiment component is constrained by imposed restrictions on the sign of inequalities at the upper and lower region of the factor space to a sub-region of the equilateral triangle formed as a result of three component mixture simplex through the q-vertices with regular sides of (q-1) dimension where q is the total number of mixture ingredients. I-optimality and D-optimality of 0.39093 and 1747.474, respectively, was obtained with G-efficiency of 64.8%.
2. The responses were derived from the experimental runs utilized for statistical fit test, and diagnostic test computation using Design expert and Minitab 18 statistical software. This provides an analytical toolbox for the simulation and analysis of mixture experiments for test soil stabilization using geogrids. Incorporated in the toolbox are statistical tools and techniques like fit summary, model equations formulation with coefficients estimation, diagnostic plots

utilizing externally studentized residuals for regression model assumptions validation, and contour plots.

3. The numerical and graphical optimization process which locates the factor levels combinations which satisfy the criteria placed on the mixture components and the corresponding response parameters based on the model fitness evaluation through statistical analysis and equation simulation using desirability function was further conducted. A desirability score of 1 was calculated as the optimal solution with the optimal combination ratio of 0.002:0.098:0.9 for geogrid, water, and soil, respectively; and an optimal response of 41.270kN/m<sup>2</sup> for UCS.
4. The results obtained from this research study on geotextile application for expansive soil UCS improvement indicated an improvement in the soil property at 0.2% by volume of geogrid, the generated strength value was greater than the minimum value specified by the American Association of State Highway and Transport officials (AASHTO) for the mechanical properties of soil.

## REFERENCES

- Demir, A., Laman, M., Yildiz, A., & Ornek, M. (2012). "Large scale field tests on geogrid-reinforced granular fill underlain by clay soil," *Geotextiles and Geomembranes*, vol. 42, pp. 1–15, 2012
- Wigena, A. H., Sumertajaya, I. M., & Syafitri, U. (2018). Constrained Experimental Regions on Ground Granulated Blast Furnace Slag Concrete, *Applied Mathematical Sciences*, Vol. 12, 2018, no. 26, 1251–1258. <https://doi.org/10.12988/ams.2018.89128>
- Alaneme, G. U., Onyelowo, K. C., Onyia, M. E., Bui Van, D., Mbadike, E. M., Dimonyeka, M. U., Attah, I. C., Ogbonna, C., Iro, U. I., Kumari S., Firoozi A. A., & Oyagbola I. (2020). Modelling Of The Swelling Potential Of Soil Treated With Quicklime-Activated Rice Husk Ash Using Fuzzy Logic, *Umudike Journal of Engineering and Technology (UJET)*; Vol. 6, No. 1, June 2020, pp. 1 – 22; doi: [https://doi.org/10.33922/j.ujet\\_v6i1\\_1](https://doi.org/10.33922/j.ujet_v6i1_1)
- American Standard for Testing Material, Annual Book of Standards Vol. 04.08, American Society for Testing and Materials, Philadelphia. 1992.
- Aslam, F., Farooq, F., Amin, M. N., et al., (2020). Application of gene expression programming for estimating compressive strength of high-strength concrete. *Advances in Civil Engineering*, Vol. 2020, article ID: 8850535. <https://doi.org/10.1155/2020/8850535>
- Indraratna, B., Ngo, N. T., & Rujikiatkamjorn, C. (2011). "Behavior of geogrid-reinforced ballast under various levels of fouling," *Geotextiles and Geomembranes*, vol. 29, no. 3, pp. 313–322, 2011
- Bello, A. A., Ige, J. A., & Tajudeen, S. (2007). Geotechnical characterization of lateritic Soils in parts of Ejigbo Local Area, South-western Nigeria. *LAUTECH J. Engr. Technol.* 4(2): 34 – 38.
- British Standard (BS) 1377 (1990) Method of testing soils for civil engineering purpose. British Standards Institution, London
- British Standard (BS) 1924 (1990) Method of testing for stabilized soils. British Standard Institution, London

- Buonsanti, M., Leonardi, G., & Scopelliti, F. (2012). Theoretical and computational analysis of airport flexible pavements reinforced with geogrids. In 7th RILEM International Conference on Cracking in Pavements; Springer: Dordrecht, the Netherlands; Berlin/Heidelberg, Germany, 2012; pp. 1219–1227.
- Jian-Tong, D., Pei-Yu, Y., Shu-Lin, L., & Jin-Quan, Z. (1999). Extreme vertices design of concrete with combined mineral admixtures. *Cement and Concrete Research*, 29(6) (1999) 957-960. [http://dx.doi.org/10.1016/S0008-8846\(99\)00069-1](http://dx.doi.org/10.1016/S0008-8846(99)00069-1)
- Damiri, S., Pouretedal, H. R., & Bakhshi, O. (2016). 'An extreme vertices mixture design approach to the optimization of methylal production process using p-toluenesulfonic acid as catalyst'. *Chem Eng Res Des* 2016;112:155–62
- Design expert 11. (2018). Design of experiment software, Stat-Ease Inc., Minneapolis, USA. 2018.
- Ding, J. T., Yan, P. Y., Liu, S. L., & Zhu, J. Q. (1999). 'Extreme vertices design of concrete with combined mineral admixtures'. *Cem Concr Res* 1999; 29(6):957–60, [http://dx.doi.org/10.1016/S0008-8846\(99\)00069-1](http://dx.doi.org/10.1016/S0008-8846(99)00069-1).
- Federal Ministry of Works and Housing (1997) General Specification for Roads and Bridges, Volume II, Federal Highway Department, FMWH: Lagos, Nigeria, 317 p.
- Guimarães, M. G. A., de Mattos, V. D., de Carvalho, U., et al. (2017). Degradation of polypropylene woven geotextile: tensile creep and weathering. *Geosynth Int* 2017; 24(2): 213–223
- Alawaji, H. A. (2001). "Settlement and bearing capacity of geogridreinforced sand over collapsible soil," *Geotextiles and Geomembranes*, vol. 19, no. 2, pp. 75–88, 2001.
- Scheffé, H. (1958). Experiments with mixtures. *Journal of the Royal Statistical Society Series B*. 20, (1958), 344-360.
- Al-Qadi, I., Dessouky, S., Kwon, J., & Tutumluer, E. (2008). "Geogrid in flexible pavements: validated mechanism," *Transportation Research Record: Journal of the Transportation Research Board*, no. 2045, pp. 102-109, 2008.
- Cornell, J. A. (2011). *Experiments with Mixtures: Designs, Models, and the Analysis of Mixture Data*, John Wiley & Sons, New York, NY, USA, 3rd edition, 2011.
- Schwartz, J., Merck, S., & Dohme, R. L. (1981). Optimization techniques in product formulation. *J Soc Cosmet Chem.*, 32 (1981) 287-301.
- Onyelowe, K. C., Alaneme, G., Bui Van, D., Nguyen Van, M., Ezugwu, C., Amhadi, T., Sosa, F., Orji, F., & Ugorji, B. (2019a). Generalized Review on EVD and Constraints Simplex Method of Materials Properties Optimization for Civil Engineering, *Civil Engineering Journal* (5) (2019) 729-749, <http://dx.doi.org/10.28991/cej-2019-03091283>
- Onyelowe, K. C., Alaneme, G., Igboayaka, C., Orji, F., Ugwuanyi, H., Bui Van, D., & Nguyen Van, M. (2019b). Scheffe optimization of swelling California bearing ratio, compressive strength, and durability potentials of quarry dust stabilized soft clay soil, *Mater. Sci. Energy Technol.* 2 (1) (2019) 67-77. <https://doi.org/10.1016/j.mset.2018.10.005>.
- Lawson, J., & Erjavec, J. (2001). *Modern Statistics for Engineering and Quality Improvement*. Duxbury, Pacific Grove.
- McLean, R. A., & Anderson, V. L. (1966). 'Extreme Vertices Design of Mixture Experiments. *Technometrics*', 8(3) 447-454.
- Minitab 18. (2018). Minitab statistical software, Minitab Inc., Pennsylvania, USA. 2018.

- Pinho-Lopes, M., Paula, A. M., & Lopes, M. L. (2018). Long-term response and design of two geosynthetics: effect of field installation damage. *Geosynth Int* 2018; 25(1): 98–117
- McLean, R. A., & Anderson, V. L. (2012). "Extreme Vertices Design of Mixture" University of Tennessee, United States.
- Salahudeen, A. B., Eberemu O. A., & Osinubi, K. J. (2014). Assessment of cement kiln dust-treated expansive soil for the construction of flexible pavements. *Geotechnical and Geological Engineering*, Springer, Vol. 32, 2014, No. 4, PP. 923-931.
- Standard Specifications for Transportation, Material and Method of Sampling and Testing, 14th Edition, American Association of State Highway and Transportation Official (AASHTO) Washington D.C. 1986
- Syafitri, U., Sartono, B., & Goos, P. (2015). I-optimal design of mixture experiments in the presence of ingredient availability constraints. *J. Qual. Technol.* 47 (2015) 220–234.
- Wangkananon, W., Phuaksaman, C., Koobkokkrud, T., & Natakankitkul, S. (2018). An extreme vertices mixture design approach to optimization of tyrosinase inhibition effects. *Engineering Journal*, 22 (1) (2018) <http://dx.doi.org/10.4186/ej.2018.22.1.175>
- Wang, J. Q., Zhou, J., & Deng, Y. B. (2010). Macro-Mesosopic study of the interface between sand and geogrid[C]//Geotechnical Special Publication No.207, In: GeoShanghai international conference, Shanghai, China, 3–5 June 2010, pp. 361–366.
- Xue, J. F., Chen, J. F., Liu, J. X., et al. (2014). Instability of a geogrid reinforced soil wall on thick soft Shanghai clay with prefabricated vertical drains: a case study. *Geotextiles Geomembranes* 2014; 42(4): 302–311
- Zhou, J., Chen, J. F., Xue, J. F., et al. (2012). Micro-mechanism of the interaction between sand and geogrid transverse ribs. *Geosynth Int* 2012; 19(6): 426–437.



# PERFORMANCE-BASED EPC CONTRACTING: A PRELIMINARY STUDY OF THE CHALLENGES OF ENGINEERING PROCUREMENT AND CONSTRUCTION PROJECTS IN NIGERIA

Aluko-Olokun Bukola Adenike<sup>1</sup>, Baba Adama Kolo<sup>2</sup>, Mustapha Abdulrazaq<sup>3</sup> and Peter C. Gangas<sup>4</sup>

<sup>1,2,3,4</sup>*Department of Quantity Surveying, Ahmadu Bello University, Zaria, Nigeria*

Engineering Procurement and Construction (EPC) project harnesses contractors' ingenuity towards delivering value by affording them flexibility in procurement. However, while EPC projects in developed economies are generally characterized as delivering value in procurement, those in Nigeria are not. The challenges responsible for these under-performances within the Nigerian construction industry remains largely unknown, this is in spite of the 2014 Federal Government Procurement Guidelines which advocated for the implementation of EPC projects using performance-based contract (PBC). Therefore, this paper aims to identify potential challenges facing EPC projects with the view to providing a structure to investigate PBC related challenges for an ongoing PhD research. The report in this paper is the outcome of a preliminary investigation involving an EPC contracting organization and a client organization in the energy sector. The interview technique was used to collect data from two respondents (one from each organization) with experience of 15 and 30 years respectively. The data collected were analysed using qualitative content analysis. The preliminary findings revealed two distinct sets of challenges, client- and contractor-specific. For instance, client-specific challenges include: "loss of control", "non-assurance of quality", and "lack of performance evaluation criteria". Contractor-specific challenges include: "client's inexperience in EPC projects", "inaccuracies contained in BOQs" and "pricing issues". Those challenges clearly have their root causes to the non-implementation of EPC projects based on PBC. This finding points to the fact that EPC projects in Nigeria are mainly based on non-PBC. With the emergence of these challenges, going further thereof, the main investigation will infuse them in a structured interview survey toward discovering the root causes of these challenges. It is hoped that such discoveries will lead to getting the ingredients necessary for developing strategies for the implementation of EPC project using PBC in the Nigerian Construction industry.

Keywords: energy sector, engineering procurement and construction (EPC), Nigeria, performance-based contracting (PBC), implementation

---

<sup>1</sup> bukolaalukoolokun@gmail.com

<sup>2</sup> babaadamakolo@gmail.com

<sup>3</sup> musteephd@gmail.com

<sup>4</sup> pcgangas@yahoo.com



## INTRODUCTION

Engineering, Procurement and Construction (EPC) approach is a rapid project delivery method that is increasingly being used for mega projects in developing economies (Singh & Tiwari, 2015). The EPC approach integrates the design, procurement and construction processes simultaneously to achieve high efficiency (Hale, Shrestha, Gibson, & Migliaccio, 2009; Guo, Xu, Zhang, & Tu, 2010), while contractors in this form of contract are not only solely responsible for these diverse aspects of the projects, but are also in charge of the quality, time and cost (Yeo & Ning 2002). EPC projects in developed economies are generally characterized as delivering value in procurement (Natalya, Navaid & Cesar, 2005; Kavanagh, 2016); however, those in Nigeria are not (Giwa, 2010; Ekweozor, 2013; Eberhard & Gratwick 2012; Eberhard, Gratwick, Morella & Antmann, 2016). The challenges responsible for these under-performances within the Nigerian construction industry remains largely unknown, this is in spite of the 2014 Federal Government Procurement Guidelines which advocated for the implementation of EPC projects using performance-based contract (PBC).

Performance Based Contract (PBC) is a contractual approach that delegates service delivery to private providers by the use of appropriate methodologies under legally binding agreements that tie at least a portion of a contractor's payment, contract extensions, or contract renewals to the achievement of specific, measurable performance standards and requirements (An & Shuai, 2011; DLA PIPER, 2011; Principles & Practice of Public Procurement, 2012; Selviaridis & Wynstra, 2015). The underlying logic of PBC is an emphasis on the specification and evaluation of outputs or outcomes rather than inputs, activities or processes required to achieve performance (Martin, 2007). The use of PBC in projects has led to cost reduction and value for money solutions (Natalya, et.al., 2005; Kavanagh, 2016), while the acquisitions of highly innovative technologies are increased because it gives the contractor the flexibility in proposing new and creative solutions with an increased profit margin (Hypko, Tilebein & Gleich, 2010). With the rapid change experienced within the construction sector, government agencies and private clients in developed and developing countries are increasingly using PBC because it is considered to lead to efficiency and effectiveness in the achievement of procurement goals, enhances accountability and minimizes corruption ( Ang, Groosman & Scholten, 2005; Greiling, 2006; Bergman & Lundberg, 2013). It is also considered as a useful tool to minimise the opportunistic behavior of contractors (Ambaw & Telgen, 2017).

In spite of the move by the Nigerian government towards the use of PBC in EPC projects, the EPC industry is observed to have suffered considerable setbacks in term of completion of projects within time and budget including excessive contract termination payments (Giwa, 2010; Mohammed & Isah, 2012; KPMG International, 2015) with service delivery generally regarded as being poor and substandard (Idris, Kura & Bashir, 2013). The World Bank sample Performance-based Management and Maintenance of Road Networks (PMMR) which was pilot tested in Kaduna State in 2011 with four road projects executed under the Rural Access and Mobility Project (RAMP 1) also suffered the absence and lack of establishment of a fully functional road management unit especially in terms of management and monitoring of compliance (Giwa, 2020). While examining the challenges of

execution and the nature of EPC, researchers observed that Clients are exposed to contractor's manipulations which could lead to cost escalation and underperformances (Yeo & Ning, 2002). This situation is said to be worse for most EPC clients in Nigeria given their relative inexperience in EPC contracts and its non-implementation as a PBC system (Giwa, 2020; Ogbu & Ehigiator-Irughe, 2020). These problems and challenges could perhaps be as a result of lack of strategy to implement PBC in EPC contracts in the Nigerian Construction Industry.

In an effort to resolve some of the issues generating from the implementation of EPC contracts, Kumar & Kumar (2004) developed a conceptual framework for service delivery strategy and implementation in an oil & gas industry that considers product characteristics and customer operational/ organisational features, however; the framework is suitable for use only at the managerial level to bridge the gap between the maintenance task and task execution level. In (2007), Kumar & Markeset also identified current practices in the Norwegian Oil & Gas industry's service strategy influencing factors namely geographical location, maintenance needs, operating environment and operational requirements and developed a framework which takes into account these influencing factors. The research focused on external and internal services needed to support (or perform) Oil & Gas operation and maintenance activities and may likely not be suitable for adaptation in other industries and countries given the peculiarity of projects and political settings. In Israel, Shohet & Nobili (2015) developed and implemented a PBC framework based on six key performance indicators that could assist an organization in developing a contract, but the framework fail to consider user satisfaction and risk assessment required to determine the risk of potential failures of the performance indicators. In Malaysia, Anwar, Shariff, Chia, Jie, Riazi, & Nawi, (2016) adopted seven sequential steps as proposed by the Office of Federal Procurement Policy, Pennsylvania to the practice of PBC; however the study did not propose any guidelines for the practice of PBC in developing countries. The available PBC frameworks emphasises result rather than processes and they are not structured along the developmental phases of an EPC project. Most were designed to suit the problems encountered in a particular country while others are sector specific which may not be ideal for use in the EPC sector in Nigeria. There is a knowledge gap in the implementation of PBC system within the developmental phases of EPC projects. As revealed in the study of Ambaw & Telgen, (2017), PBC can minimise some of the most common problems of public procurement in developing countries, and this presupposes that the problems of EPC projects in Nigeria may not abate without the appropriate PBC frameworks in place for its implementation.

This paper looks into the potential challenges facing EPC projects within the Nigerian Construction Industry with the view to providing a structure to investigate PBC related issues for an ongoing PhD research. The main investigation will infuse the findings in a structured interview survey with a goal of developing a framework for the implementation of PBC in EPC projects in the Nigerian construction industry. It is hoped that such discoveries will provide a way to positively address the underperformances of EPC project within the Nigerian Construction Industry.

### **Concept of Engineering Procurement and Construction (EPC) contracts**

The construction industry is currently making efficient use of an innovative procurement approach in the name of Engineering Procurement and Construction (EPC) contracts (Singh & Tiwari, 2015). EPC is a fixed phrase which originated from U.S.A. project circle and is categorised under Integrated Engineering Contracts which deal with construction issues with greater sophistication than other types of construction contracts (An & Shuai, 2011, DLA PIPER, 2011). Some countries also use EPC as a variant of design and build (DB) (Ang et al. 2005; Murdoch & Hughes, 2008) or in the form of Turnkey projects (Ellsworth, 2003) and EPC is now being used as part of the DB market for large and complex industrial projects most of which are in the oil and gas, power, processing and mining industries (Xia & Chan, 2008; Kevin, 2013). Under the EPC approach, the Contractor is, just as under the DB arrangement, still the one-stop shop for all implementation activities beyond the basic design to include the detail design and, sometimes, also undertake the preceding Front-End Engineering design [FEED] work (Salmon, 2020). This form of contract, as described by FIDIC, are contracts where one entity takes total responsibility for the design and execution of an engineering project to provide a fully equipped facility, ready for operation whilst the owner is only responsible for proposing the anticipated target, functional requirement and design standard of the project. According to Salmon, (2020), the client's team will also be more deeply involved in approving the Contractor's work during the implementation process. Such deeper involvement is primarily needed to ensure that suitable 'checks and balances' are employed to confirm, as far as possible, that the completed facility can be operated safely. Similarly, the Institution of Civil Engineers (ICE, 2004) while analysing the need to monitor EPC projects, proposed a condition of contract which also held the contractors responsible for all aspects of design and construction. Thus, EPC contracts have enormous construction scale and involve substantial capital investments, growing construction complexities, vulnerabilities and uncertainties (Wei et al., 2012).

### **Concepts of Performance based contract (PBC)**

The concept of performance based contracting is not new and has been in use for a long time especially in design and build (DB) projects under the private finance initiative (PFI) where payment is based on the performance of a facility, rather than based on work in progress. This PFI approach to construction in other parts of the world has been referred to design, build, finance and operates (DBFO), and sometimes build, own, operate, transfer (BOOT) (Murdoch & Hughes, 2008). A major feature underlying the successes of PBCs is the payments for performance or service levels obligations defined in the contract and not on the amount of works and services executed; however, how to achieve the stipulated output is left to the contractors to decide (Hypko, et al., 2010). Thus, a contractor under this strategy is not obligated to follow the detailed technical specifications of the client; instead, the contractor accepts full responsibility for how to achieve the desired outcome (Sols, Nowick & Verma, 2007; Glas & Essig, 2008). This approach implies a transfer of risks to the contractor (Doerr et al., 2005) who would need assets that are worth more than the potential losses that might occur in the event that the facility failed to perform (Murdoch & Hughes, 2008) but, conversely, encourages the contractor to improve performance during the contract period according to the implemented incentives and sanctions (Randall, Nowick, Deshpande & Lusch, 2014). Hence the

choice and application of innovative technology / materials, work selection, design and delivery, processes and management are all up to the contractor as long as there is compliance with the relevant laws and regulations (Doerr Lewis & Eaton, 2005; Guide to PBRMC, 2018).

## **METHODOLOGY**

### **Research Method**

Qualitative research method was adopted for this work because it is ideal in identifying and examining the characteristic and structure of a phenomena/ events in their natural context (Jonker & Pennink, 2010). In this study, the barriers to the implementation of performance based contracting system were examined from the point of view of the participants in their various organisations. The 'open 'attitude required in the qualitative approach will enable the researcher to understand how the participants experience their situation within a specific context which in this case is within the EPC industry.

### **Sample selection**

According to Kumar (2011), sample sizes do not occupy a significant place in qualitative research; so in order to obtain a broad picture of the challenges facing the EPC projects, a preliminary investigation was conducted on a selected EPC contracting organization and a client organization that is active and have undertaken minimum of ten (10) EPC projects in the energy sector of the Nigerian Construction Industry. These two organisations were selected from the target population with aim of having access to relevant data in the area of study and also to be able to compare and contrast their respective opinions based on the perceived challenges experienced within the sector. Purposive sampling was used to select the participants that were drawn from each of the sector. The inclusive criteria is their active involvement in the implementation of EPC projects from the pre-contract and up to the execution and handing over stages of the project and must have worked on more than five (5) projects with a minimum of (10) years working experience. A Consultant Architect who has been handling the contractual aspect of the EPC contracting within the client organisation and a Chief Engineer within the contracting organisation with 15 and 30 years working experience respectively fell into these categories. They were both willing and available to participate in the preliminary investigation.

### **Data collection Instruments**

Qualitative interview technique was adopted with the use of open ended questions to elicit information from the participants while a theoretical review was carried out to construct questions that fit the purposive research and to add rigor (Sekaran, 1984).The structured interviews lasted for 60minutes and 75minutes respectively. A table was prepared to compare the result of the findings from each participant using qualitative content analysis and the data was analysed manually based on the structured themes developed for the interview.

## RESULT AND DISCUSSION

**Table 1: Respondents reasons for the non-use of PBC**

**What are the key issues surrounding the non-use of PBC in EPC projects in Nigeria?**

Interviewee 1 (Client Organisation)	Interviewee 2 (Contracting Organisation)
<p>Most EPC contracts are usually for heavy engineering projects and most rely on imported materials and equipment. Importation and clearing is a challenge in terms of timeline where EPC contractor must have given an estimated timeline to complete the project....</p> <p>There is need to define upfront the measurement criteria and because it is not finite, there is that flexibility which makes it become challenging</p> <p>Because EPC is a multi –disciplinary conceptual project, a lot of collaboration is required and there are instances where you cannot work according to the BOQ because what is on the drawings may not fit 100% into the work on site.</p>	<p>Importation and clearing at the port is a challenge in terms of meeting the timelines</p> <p>The client rely more on the consultants and usually follows the consultant’s dictates and recommendations on the use and nature of the procurement system to be used.</p> <p>There are challenges in deploying such models because the contract price is not prepared and calculated based on the new design but based on certain understanding of how a model which is similar to the design at hand should work.</p> <p>The price is set by the client and not by the contractor and most cost estimates do not reflect the correct price needed to execute the works. Variation will therefore set in.</p>

**Table 2: Respondents awareness of PBC**

**Are you perhaps aware of the 2014 procurement guidelines within the energy sector? If so why is it not being implemented?**

Interviewee 1 (Client Organisation)	Interviewee 2 (Contracting Organisation)
<p>Yes. Consultants do not usually recommend this contracting system because they believe that they will loss control over the contractor’s deliverables.</p> <p>PBC is not easily adopted especially with the understanding that if the client pays on performance, the client gets the performance but may not get value for his money and time is of essence.</p>	<p>Yes. The client relies mostly on the consultants to implement this guidelines, but the consultants would rather go with the traditional procurement system because do not see it as a viable option meant to accelerate the project.</p>

**Table 3: Respondents ways of expressing their objectives to the contractors**

**How do you express the purpose and needs of your project to the contractors?**

Interviewee 1 (Client Organisation)	Interviewee 2 (Contracting Organisation)
<p>The regular consultants are used to the prescriptive specifications rather than the functional but majority employs a combination of the two usually called a hybrid.</p>	<p>There is no universal means of communication but majority uses a hybrid specification.</p>

**Table 4: Respondents structure of payment**

**What is the structure of the payment, and is payment performance linked?**

Interviewee 1 (Client Organisation)	Interviewee 2 (Contracting Organisation)
Depends on the contractor. Sometimes 15% down payment, letter of credit for another 25 or 30% which is used to secure 50% of the payment. Balance is paid at the end of the project. We also use milestone payment and deferred payment whereby the balance is spread out based on the agreement with the contractor.	Some clients pay pre-mobilisation, the contractor get to site, set up their equipment and upon that they now mobilise based on milestone and at the end of the project, they demobilize and pay retention and final fees.
No. payment is not performance linked. When going with milestone payment, procurement system is not generic, you can tweak it.	Yes. Milestone payment is performance linked.

**Table 5: Challenges involved in the implementation of EPC projects as enumerated by the respondents.**

**What are the challenges involved in the implementation of EPC projects?**

Interviewee 1 (Client Organisation)	Interviewee 2 (Contracting Organisation)
-------------------------------------	------------------------------------------

**Table 6: Respondents use of incentives.**

**Do you use incentives to encourage the contractors to ensure a better performance?**

Interviewee 1 (Client Organisation)	Interviewee 2 (Contracting Organisation)
No. if a client chooses a contractor to perform a certain service; it means the contractor has presented himself to have the capability to deliver the project. The client will therefore not give an incentive to deliver.	None, except for a promise that you will be considered favourably in other projects.

**Table 7: Respondents opinion on ways to achieve improved performance**

**What in your opinion can be done to improve upon the existing performance of EPC projects in Nigeria?**

Interviewee 1 (Client Organisation)	Interviewee 2 (Contracting Organisation)
To define output performance	Attitude of the parties should change especially the project and procurement leads.
To build in monitoring processes at different stages such as testing and inspection and documentation	Fulfillment of obligations from the client that obstruct the progress of the work of the contractor
Clients should engage consultants that are versed in the concept and processes of EPC contracts.	Sincerity of contract not to over labour the other party for most contracts are skewed to favour the client and contractor would have to be smart to improvise or otherwise cheat the client.

The following analyses are the outcome of the interviews

1. Key Issues involved in the non-use of PBC- as shown in table 1, the issues common to the parties is the importation challenge which is a risk factor in PBC. As noted in previous research, the contractor may not be able to exercise any influence on external conditions (Buse, Freiling & Weissenfels, 2001; Hypko et al., 2010); however, researchers also opined that contractors may be averse to increased risk especially when they perceive that they possess limited capacity to manage them (Abedi & Haghifam 2013; Gruneberg et al., 2007). The data also indicated the lack of institutional capacity on the part of the client to make them rely solely on the consultants and undefined measurement criteria by the contractors to enable the clients link it to measurable goals. This is importantly consistent with literature (Doerr et al., 2005; Schoenmaker & Bruijn, 2016) as one of the key factors militating against the use of PBC in other countries. Pricing issue seems to be unique to the EPC industry in Nigeria; however, literature recognizes that if the contract is properly designed considering performance end results, PBC can help to improve the procurement by plugging the leaks found in the traditional procurement system (Ambaw & Telgen, 2017).
2. Awareness of PBC guidelines- in table 2, the data indicates that the respondents are aware of the PBC guidelines but the clients prefer the traditional methods so as not to loss control over the contractors 'deliverables and may not be fully assured of the quality. This is in alignment with the findings of Doerr et al., (2005) of the difficulty in promoting performance based oriented approach that is different from the traditional mindset. Burguet & Che (2004) also observe that when procurement entities procure new technologies in PBC, non-standard goods and services are usually difficult to evaluate objectively and as such the Contractor may fail to meet the required expectations in terms of quality (Hughes & Kabiri, 2013). As compared to the traditional approach, PBC holds contractors accountable for providing a specific service, which can be measured in terms of "quality, outputs and outcomes" (Martin, 2000).
3. Ways of expressing the objectives of the project- tables 3 indicates that the clients uses a hybrid of both the prescriptive and functional means of expressing the project objectives to the contractors; however, Sultana, Rahman, & Chowdhury, (2012) are of the opinion that even though there is nothing wrong with the use of detailed specifications for procurement of some goods and services, PBC uses qualitative criteria which helps to achieve the intended result. Using PBC is considered to be a solution for these problems in the procurement system since procuring entities does not have to describe the detailed technical specification but just simply specify the expected results to be achieved (Ambaw & Telgen, 2017).
4. Structure of payment- the response in table 4 indicates that milestone payment seems to be the preferred means of payment but the client is of the opinion that payment is not performance linked while the contractor believes that milestone payment is performance linked. McLellan, Kemp, Brooks & Carise, (2008) observed that milestone payment is common because service output /outcome may be non-verifiable and contractors are too often reluctant to

agree to contracts where payment is totally linked to performance due to the resultant financial risks. Other forms of payment are also dependent on the parties as opined by Donna, Jennifer & Carrie (2004) for it is difficult to develop the payment structure that is directly linked to performance.

5. Implementation challenges- table 5 highlights the implementation challenges experienced by the respondents in their respective organisations. The challenges identified here are consistent with what is obtainable in other developing economies, such as: incapability of the contractor and competitiveness (Dennis & William, 2003); difficulty in measuring performance (Datta & Roy, 2011; Anwar et al., 2016); enhancement of corruption in public procurement (Burguet & Che, 2004, Schoenmaker & Bruijn, 2016; Ambaw & Telgen, 2017); lack of training and experience (Donna et al., 2004) and unfamiliarity with the contracting system (Anwar et al., 2016) including unanticipated environmental problems (Hughes & Kabiri, 2013) have been identified in other researches. Because of the inherent implementation challenges in PBC, Loulakis, (2013) advised that it is important for the procuring entities to have a clear understanding of these problems as well as a strategy for dealing with them in the procurement and contracting of projects.
6. Use of incentives- table 6 shows that the respondents both agree that incentives are not used to motivate the contractors into achieving a better performance. This is contrary to one of the basic features of PBC. Datta & Roy, (2011) observed that PBC uses key performance indicators (KPIs) and incentives to improve upon the outcome of projects during the contract period; however, within the context of EPC contracts, literature noted that the willingness of the employer to discuss any incentives for earlier completion or better performance is not discussed within the framework of the EPC negotiations nor is it included in the tender (EPC Guide, 2013). However, if the employer desires to reduce project costs, this can be achieved by setting up incentives for the contractor by allowing them to participate to a certain percentage in any savings yielded by the contractor.
7. Ways of achieving improved performance- the respondents in table 7 are of the opinion that output performance should be well defined as a way of improving the performance of the projects. Monitoring strategies as well as the employment of experienced consultants are necessary towards achieving a proper implementation of the projects. Parties to the contract should also try to adapt and be more receptive towards the use of PBC while fulfilling their various obligations on a fair contract that puts into consideration the interest of the contracting parties. A full implementation of PBC in the EPC contracts in Nigeria will assist in overcoming the disadvantages of the traditional method of contracting (Guide to PBRMC, 2018).

## **CONCLUSION**

EPC projects in developed economies have been characterized as delivering value in procurement while those in Nigeria is surrounded by a number of problems that is hindering it from achieving value for money. To this end, the objective of this preliminary study is to identify the challenges responsible for the under-



performances experienced within the EPC sector of the Nigerian Construction industry. The data analysis revealed that the implementation of EPC projects in Nigeria are not performance based and there is a need for a framework to be developed to ensure a full implementation of PBC in EPC projects to overcome the reported challenges. With the emergence of these findings, going further thereof, the main investigation will infuse them in a structured interview survey toward discovering other issues relating to the EPC sector of Nigerian economy. It is hoped that such discoveries will lead to getting the ingredients necessary for developing a framework for the implementation of EPC project as a PBC system in the Nigerian Construction industry. This study major contribution to knowledge is that it suggests the need for the full implementation of EPC as a PBC project so as to gain control of the full benefits of PBC in Nigeria. The framework will put into consideration the peculiar challenges encountered in practice and propose a solution that will enhance the knowledge base of clients in building institutional capacities and improve the capability of contractors towards the achievement of project goals.

## REFERENCES

- Abedi, S. M., & Haghifam, M. R. (2013) Comparing Reliability Insurance Scheme to Performance-based Regulation in Terms of Consumers 'Preferences, *IET Generation Transmission & Distribution* 7 (6): 655–663
- Ambaw, B. A., & Telgen, J. (2017) PBC as a Solution for Public Procurement Problems: Some Ethiopian Evidence, *European Journal of Business and Management*, Vol.9, No.34
- Anwar, M. F., Shariff, N. M., Chia, T. C., Jie, L. X., Riazi, S. M. & Nawi, M. M., (2016), Implementation of Performance Based Contracting in Malaysia, *International Review of Management and Marketing*, 2016, 6(S8) 286-293.
- An, H., & Shuai, Q. (2011) Analysis of Risk in EPC Project and the Counter measures, *International journal of Environmental Engineering*, 978-1-4244-8385
- Ang, G., Groosman, M., & Scholten, N. P. M. (2005) Dutch Performance-based Approach to Building Regulations and Public Procurement, *Building Resource Information*, 33(2), 107–119.
- Bergman, M. A., & Lundberg, S. (2013). Tender Evaluation and Supplier Selection Methods in Public Procurement, *Journal of Purchasing and Supply Management*, 19(2), 73-83. doi:<http://doi.org/10.1016/j.pursup.2013.02.003>
- Buse, C., Freiling, J. & Weissenfels, S. (2001), "Turning Product Business into Service Business: performance contracting as a challenge of SME customer/supplier networks", paper presented at the 17th IMP-Conference, Oslo, available at: [www.impgroup.org/uploads/papers/4277.pdf](http://www.impgroup.org/uploads/papers/4277.pdf)
- Burguet, R. & Che, Y.K. (2004) Competitive Procurement with Corruption, *the RAND Journal of Economics* 35(1) 50-68
- Datta, P. P., & Roy, R. (2011), Operations strategy for the effective delivery of integrated Industrial product service offerings: Two exploratory defense industry case studies, *International Journal of Operations and Production Management*, Vol. 31 No. 5, pp. 579-603.
- DLA PIPER (2011). EPC Contracts in the Power Sector, *Asia Pacific Projects Update*.

- Doerr, K., Lewis, I., & Eaton, D. R. (2005), Measurement Issues in Performance-based Logistics, *Journal of Public Procurement*, 5(2), 164-186
- Donna, D., Jennifer, T. T., & Carrie, G. (2004) Innovations in Performance Based Contracting
- Eberhard, A., & K. Gratwick (2012) "Light Inside: The Experience of Independent Power Projects in Nigeria," Infrastructure Consortium for Africa Working Paper, Tunis
- Eberhard, A., Gratwick, K., Morella, E., & Antmann, P. (2016) Independent Power Projects in Sub-Saharan Africa Lessons from Five Key Countries.
- Ekweozor, C. O. (2013) Analysis of Constructability Practice in Project Delivery Process in the Nigerian Engineering/Construction Industry (Unpublished Thesis) School Of Management Technology, Federal University Of Technology, Owerri, Nigeria
- Ellsworth, R. K. (2003). Turnkey Premiums for Turnkey Projects, *Construction Accounting & Taxation*, 13(4), 18-21.
- Engineering, Procurement and Construction Contracts for Large Scale Projects (2013) A Practical Guide to EPC Contracting and Claim Management, Essen/Germany
- Dennis, C.S., William, J.G. (2003), The Promise and Pitfalls of Performance-Based Contracting. Paper Presented at the 25th Annual Research Conference of the Association for Public Policy Analysis and Management (APPAM). Washington, DC.
- FIDIC (1999), (The Silver Book), Conditions of Contract for EPC/Turnkey Projects, 1st Ed, Fédération Internationale des Ingénieurs-Conseils
- Giwa, F. A. (2010), Failures of Independent Power Producers in Nigeria: The Inimical Challenges, University of Applied Sciences, Business Economics and Tourism
- Giwa, Y, S. (2020) Output and Performance-Based Road Contracts (OPRC) Kaduna State Experience, Nigeria Guide to Performance Based Road Management Contracts (2018) ISBN 978-92-9261-108-8 (print), 978-92-9261-109-5 (electronic) Publication Stock No. TIM179099-2 DOI: <http://dx.doi.org/10.22617/TIM179099-2>
- Glas, A. & Essig, M. (2008), "Public Performance Contracting of Solutions: Benefits and Consequences", Proceeding of Annual Conference of the International Purchasing & Supply Education & Research Association Conference, Perth, Australia
- Greiling, D. (2006). Performance Measurement: A Remedy for Increasing the Efficiency of Public Services, *International Journal of Productivity and Performance Management*, 55(6), 448-465.
- Gruneberg, S., Hughes, W., & Ancell, D. (2007) Risk Under Performance-based Contracting in The UK Construction Sector, *Construction Management and Economics*, 25, 691-699. doi:10.1080/01446190601164097
- Guo, Q., Xu, Z. P., Zhang, G. F., Tu, T. T. (2010) Comparative Analysis between the EPC Contract mode and the Traditional Mode based on the Transaction Cost Theory, in 2010 IEEE 17th International Conference on Industrial Engineering and Engineering Management, 2010, 191-195.
- Hale, D., Shrestha, P., Gibson, G., Jr., & Migliaccio, G. (2009), —Empirical Comparison of Design/Build and Design/Bid/Build Project Delivery Methods, *Journal of Construction Engineering and Management*, 10.1061/(ASCE)CO.1943-7862.0000017, 579-587
- Hughes, W., & Kabiri, S. (2013) Performance-based contracting in the construction sector, School of Construction Management and Engineering, University of Reading

- Hypko, P., Tilebein, M. & Gleich, R. (2010), "Benefits and Uncertainties of Performance-based Contracting in manufacturing industries: An Agency Theory Perspective, *Journal of Service Management* Vol. 21 No. 4, 2010 pp. 460-489, Emerald Group Publishing Limited 1757-5818 DOI 10.1108/09564231011066114
- Institution of Civil Engineers (2004) conditions of contract design and construct 2nd Edition
- Idris, A., Kura, S. M., & Bashir, M. U. (2013) Public Private Partnership in Nigeria and Improvement in Service Delivery: An appraisal, *IOSR Journal of Humanities and Social Science (IOSR-JHSS)* Volume 10, Issue 3, PP 63-71
- Jonker & Pennink (2010) *The Essence of Research Methodology*, ISBN: 978-3-540-71658-7 e-ISBN: 978-3-540-71659-4 DOI 10.1007/978-3-540-71659-4 Springer Heidelberg Dordrecht London New York
- Kavanagh, P. (2016) A Case for Negotiated Performance-Based Contracting Rather than Competitive Tendering In Government Public Transport (Bus) Service Procurement, *Journal in Transportation Economics*, 1(4), 1-10
- Kevin, B. (2013). Region's EPC market set for a golden age, *MEED-Middle East Business Intelligence*, Retrieved from <http://www.meed.com/supplements/2013/engineering-procurement-andconstruction-in-the-middle-east-2013/regions-epc-market-set-for-a-goldenage/3185555.article>
- KPMG International (2015) *Global construction Project Owner's Survey: Climbing the curve.*
- Kumar, R. & Kumar, U. (2004), "A Conceptual Framework for the Development of a Service Delivery strategy for industrial systems and products", *Journal of Business & Industrial Marketing*, Vol. 19 No. 5, pp. 310-19
- Kumar, R. & Markeset, T. (2007), "Development of Performance-Based Service Strategies For The Oil And Gas Industry: A Case Study", *Journal of Business & Industrial Marketing*, Vol. 22 No. 4, pp. 272-80.
- Kumar, R. (2011) *Research methodology: a step-by-step guide for beginners*, 3 rd ed., London: Sage
- Loulakis, M. C. (2013), *Legal Aspects for Performance-Based Specifications for Highway Construction and Maintenance Contracts*, NCHRP Legal Research Digest 61, National Cooperative Highway Research Program, Transportation Research Board
- Martin, L. L. (2000). Performance Contracting in the Human Services: An Analysis of Selected State Practices. *Administration in Social Work*, 24(2), 29-43. doi:10.1300/J147v24n02\_03
- Martin, L. L. (2007). Performance-based contracting for human Services: A proposed model, *Public Administration Quarterly*, Vol. 31 No. 2, pp. 130-151
- Mohammed, K. A., & Isah, A. D. (2012) Causes of Delay in Nigeria Construction Industry, *Interdisciplinary Journal of Contemporary Research in Business*, Institute of Interdisciplinary Business Research 785 VOL. 4, NO 2
- Murdoch J. & Hughes, W., (2008) *Construction Contracts: Law and Management* 4th edition, Taylor & Francis, 270 Madison Ave, New York, NY 10016, USA
- Natalya, S., Navaid, Q., Cesar, Q. (2005) *Performance-Based Contracting for Preservation and Improvement of Road Assets*, Washington, DC: Transport Note

- Ogbu, C. P. & Ehigiator-Irughe, R. (2020) Cost Over-Run in Civil Works: A Case-Study of Engineering, Procurement and Construction (EPC) Gas Depot Construction Projects in Nigeria, *European Journal of Environment and Earth Sciences* [www.ej-geo.org](http://www.ej-geo.org)
- Randall, W. S., Nowick, D. R., Deshpande, G., & Lusch, R. F. (2014) Converting knowledge into value: Gaining insights from service dominant logic and neuroeconomics, *International Journal of Physical Distribution Logistics and Management* 44(8/9):655–670
- Selviaridis, K., & Wynstra, F. (2015), "Performance-based Contracting: a Literature review and Future research directions", *International Journal of Production Research*, Vol. 53 No. 12, pp. 3505-3540
- Schoenmaker, R., & De Bruijn, H. (2016), "Embracing Complexity in Performance-Based Contracts for road maintenance", *International Journal of Productivity and Performance Management*, Vol. 65 No. 1, pp. 4-24
- Shohet, I. M & Nobili, L. (2015), Performance-Based Maintenance of Public Facilities: Principles and Implementation in Courthouses, *Journal of Performance of Constructed Facilities*, ASCE, ISSN 0887-3828
- Singh, A. R., & Tiwari, S., (2015) EPC: An Innovative Tool for Mega Project Construction *International Journal in IT and Engineering*, Impact Factor- 4.747 (IJITE) Vol.03 Issue-07 ISSN: 2321-1776
- Sols, A., Nowick, D., & Verma, D. (2007), "Defining the Fundamental Framework of an Effective Performance-Based Logistics (PBL) contract", *Engineering Management Journal*, Vol. 19 No. 2, pp. 40-50
- Sultana, M., Rahman, A., & Chowdhury, S. (2012). Performance-based Maintenance of Road Infrastructure by Contracting: A Challenge for Developing Countries. *Journal of Service Science and Management*, 5, 118- 123, doi:10.4236/jssm.2012.52015
- Wei, L., Haigui, K., & Jinbo, S. (2012). A Study on Risk Allocation for International Hydropower General Contracting Projects, *Advances in Information Sciences and Service Sciences*, Vol. 4, No. 5
- Xia, B., & Chan, A. (2008) Review of the design-build market in the People's Republic of China. *Journal of Construction Procurement*, 14(2), 108-117
- Yeo, K. T., & Ning, J. H. (2002) Integrating Supply Chain and Critical Chain Concepts in Engineer-Procure-Construct (EPC) projects, *International Journal of Project Management*, 20(4), 253- 262



# PREDICTORS OF ACADEMIC ATTAINMENT IN A NIGERIAN POLYTECHNIC: PERCEPTIONS OF ESTATE MANAGEMENT STUDENTS

Augustina Chiwuzie<sup>1</sup>

*Department of Estate Management, The Federal Polytechnic Ede, Nigeria*

Determinants of students' academic performance have continued to receive substantial consideration in the extant literature, and it remains a contested subject. Students' performance is influenced by different individual factors grouped under several themes, including school factors, teaching methods, assessment methods, lecturers, students' factors, and parental background. The influences of these factors are thought to vary from one academic environment to another. This study investigates estate management students' perceptions of predictors of academic attainment in Federal Polytechnic Ede, Nigeria, intending to identify critical areas that could inform reform. This study employs a quantitative research design to examine 35 individual factors under the six thematic categories earlier mentioned. All graduating students were examined, and a sample of 86 students was selected through purposive sampling. Descriptive statistics (mean score and standard deviation) were applied. The results revealed 23 out of the 35 individual factors as significant predictors of Estate Management students' academic attainment. A further analysis based on the thematic categories showed that assessment methods, lecturers and family background with mean values of 5.20, 4.74 and 4.67, respectively, are the top three thematic categories that predict Estate Management students' academic attainment. The paper concludes that there is a need to review the approach employed in imparting knowledge and assessment of Estate Management students. Improved lecturers' attitudes and assessment strategies are necessary to heighten the students' morale, which would, in turn, translate to better academic attainment.

Keywords: academic performance, Ede, graduating students, real estate

## INTRODUCTION

Education provides the necessary knowledge and skills for future career success. Higher education plays a critical role in a country's economic development and serves as an interface between students and industries (Dahie et al., 2017). Real estate graduates' education has always been a primary concern for the profession's various stakeholders, including academic institutions, professional bodies such as the Nigerian Institution of Estate Surveyors and Valuers (NIESV) and industry employers. Academic institutions are expected to produce graduates capable of

---

<sup>1</sup> okaugusta@yahoo.com

analysing and interpreting location and markets and finance, taxation, and law to acquire the skills necessary for local, regional, and international labour markets. Students' academic performance is the most appropriate criterion for determining the quality and efficacy of teaching and a crucial determinant in the quality of graduates created for industry employers (Peter et al., 2016). Low academic attainment and failure result in students dropping out of school or semi-qualified graduates, all of which undermine students' chances of getting hired and also, affect the standard of service provided to the employer.

Students' academic performance in tertiary educational institutions is declining (Hijazi and Noqvi, 2006). Many studies have looked into the influencing factors of students' academic accomplishment with various focuses. It is widely acknowledged that numerous individual factors influence students' academic performance. Individual factors have been broadly classified as academic or non-academic and grouped into several themes, including school environmental factors, teaching methods, lecturers, assessment methods, student personal characteristics and parental/family background. These factors are directly or indirectly associated with a student's academic achievement (Gajghat et al., 2017). There are many perspectives on the effect of these variables. Previous research shows that the opinions presented by numerous studies are contradictory. Some researchers argue that personal characteristics and socioeconomic background are more significant, while others argue that lecturers, school/environmental variables have a more significant impact on students' academic performance. Findings from earlier studies suggest that students' academic success is likely to be affected by several factors. These factors are thought to vary from person to person and from one academic setting to the next. This study investigates perceptions of estate management students on the critical factors (both on individual and thematic categories) affecting academic attainment in Federal Polytechnic Ede, Nigeria intending to identify critical areas that could inform reform. This study adds to existing literature on academic performance in higher education from the perspective of Polytechnics in developing countries. The next section presents a review of literature on factors influencing students' academic achievements, followed by the methodology section. The subsequent section contains the findings and discussion, which is followed by a concluding remark.

## LITERATURE REVIEW

Many studies have been conducted around the world to determine the factors that influence student academic performance. Various individual factors are broadly classified as intellectual and non-intellectual factors (Allen and Carter, 2007), academic factors and non-academic factors (Laurel et al., 2008), or internal and external classroom factors (Mushtaq and Khan, 2012). Lecturer competence, lecturing techniques and the quality of instruction materials are academic variables that have a significant positive effect on students' academic achievements (Yam and Rossini, 2012; Ganyaupfu, 2013; Enu and Akum, 2015). According to Ganyaupfu (2013) and Adediwura and Tayo (2007), a lecturer's ability to comprehend and transform knowledge, subject mastery, teaching skills, lecturer attitude and lecturer attendance are essential for effective teaching and students' academic performance. Kang'ahi et al. (2012) earlier attributed poor students' academic achievement to poor teaching styles. Also, Rasul and Bukhsh (2011) found that

changes in the pattern of question papers near examinations, unfair means in examinations, and a lack of proper guidance all have a significant impact on student performance. Muzenda (2013) reported that high teacher absenteeism hurts students' overall academic performance. Furthermore, Hayat et al. (2013) submitted that academic success was affected by the extent of students' participation in their studies, their studies' quality, their relationships with their peers, and their environmental indulgence. Bennett and Yalams (2013) found a positive and significant relationship between student's attendance, participation in the class and academic performance. Meanwhile, Zakaria et al. (2011) suggested that students who were given college accommodations had better academic performance than students who lived in private accommodations. In Dengra et al. (2013), extra-curricular actions, instruction strategies and class contact hours were all established as critical factors impacting students' academic attainments.

On the other hand, non-academic or external classroom factors include personal factors, financial factors, family background, parents' level of education and involvement (Laurel et al., 2008; Fan and Williams, 2010). In analysing the impact of factors such as peer pressure, school and family on students' academic success, Barry (2005) found that socioeconomic status is one of the main predictors of academic success. Okioga (2013) also indicated that socioeconomic background significantly impacted students' academic success. In Bahar (2010), gender, family support and sociometric status were identified as crucial predictors of students' academic achievement. Kamau (2013) reported that the parent's education level, family size, family financial status, and type of family, whether cohesive or conflictive, had a significant relationship with students' academic performance while their marital status did not. The results of Kamau also showed that the parents' education level explained only 7 per cent of students' academic achievement. Moreover, Lee and Mallik (2015) claimed that entry qualification and age influenced students' academic performance. Ayodele et al. (2016) affirmed that the main factors impacting students' academic success are their passion an academic discipline, age and maturity. Olatunji et al. (2016) cited concentration, lack of reading habit and reading plan, fear, class size and peer group as the five most important factors impacting on students' academic success in the discipline.

It is worthy to mention that research concerning students' academic performance is extensive and ongoing. Within this body of research, limited studies have examined variables influencing academic attainment of real estate students in a number of institutions. In the international context, the studies of Allen and Carter (2007) and Huffman (2011) in the United States; Yam and Rossini (2012), Lee and Mallik (2015) provided valuable evidence from Australia. The efforts of Peter et al. (2016), Olatunji et al. (2016), Ayodele et al., (2016, 2017), Akinbogun (2018) and Ojetunde et al. (2020) are noteworthy in the Nigerian context. Findings from these representative studies suggest that academic success is affected by a variety of variables that differ from one academic environment to the next, from one group of students to the next, and also from one cultural setting to the next. Meanwhile, the preceding evidence indicates the presence of many studies and subject consistency over time, but with conflicting results about the factors affecting academic attainment. More so, the majority of research on factors influencing students' academic performance has primarily concentrated on universities and colleges (see also, Ganyaupfu (2013) in South Africa, Kanagi et al. (2015) in

Malaysia, Gajghat et al. (2017) in India, Ayodele et al., (2016, 2017), Ojetunde et al. (2020) in Nigeria. As a result, there is a scarcity of research on academic activities and student performance in the Polytechnics. This study adds to the existing literature on academic performance in higher education from the perspective of Polytechnics in developing countries. Ayodele et al. (2017) identified and categorised the various individual influencing factors into six themes: school factors, teaching methods, lecturers, assessment methods, student factors and family background as shown in Table 1. This current study employs the variables in Table 1 to assess the academic attainment of estate management students at a Nigerian polytechnic.

**Table 1: Grouping of factors influencing students' academic achievements**

Themes	Individual factor	Authors
School factors	The school's academic calendar Accommodation type and quality Conducive lecture halls, Sufficient lecture halls, The school's overall environment	Yeshmerbat et al. (2013), Adedapo et al. (2015)
Teaching methods	Integration of ICT into the classroom Student's participation in class Tutorials and seminars Excursions Contact hours Use of more practical than theories	Dengra et al. (2013), Oladokun and Ayodele (2015)
Lecturers	Scope and depth of the lecturers' knowledge Lecturers' accessibility Lecturers' commitment Lecturers' ability to clarify complex concepts Sufficiency/adequacy of lecturers Method/style of teaching	Newell and Archeampong (2003), Ganyaupfu (2013), Dengra et al. (2013)
Assessment methods	Fairness in-class assessments Grades reflecting the effort expended in studying Adequate instruction materials Sufficient time to learn and assimilate before being tested The lecturers appear to be more concerned in testing what is memorised than what is genuinely understood	Crews (2004), Oloyede and Adegoke (2007)
Students' factors	Inability to enrol in a desired course of study Age/ Maturity It is difficult to understand the courses that are being taught Study hours A thorough understanding of the field of study Passion for the course of study Participation in extra-curricular activities	Victor (2011), Gambo et al. (2012), Hayat et al. (2013), Dengra et al. (2013), Kanagi et al. (2015)
Family background	Parent's involvement in my studies Parents' occupations and educational backgrounds My position and the size of my family Availability of financial resources Family pressure to succeed in one's chosen course of study Family set-up/ background	Noble et al. (2006), Kyoshiba (2009), Okoiga (2013), Kanagi et al. (2015)

Source: Adapted from Ayodele et al. (2017).



## METHODOLOGY

This study's target population consists of graduating real estate students of Federal Polytechnic Ede, South-western Nigeria. Graduating students were chosen as it is anticipated that they would have greater knowledge than students in lower grades. Their perception level would represent current realities, allowing them to provide more accurate answers to the research questions. The sample frame for the study consisted of all HND II real estate students in the institution referred to above. The study used a self-administered close-ended questionnaire to elicit the respondents' perceptions of the factors that affect their academic success. Extant literature was used to identify the variables influencing estate management students' academic achievement (see Table I). The variables are divided into six thematic categories: school factors, teaching methods, lecturers, assessment methods, students' factors, and parental/family background. The respondents were requested to rate a set of established variables on each theme regarding how they affect their academic performance using a 7-point Likert scale (1-strongly disagree to 7-strongly agree). A 7-point Likert scale was employed to provide deeper insights on the question raised in line with earlier studies such as Ayodele et al. (2017). A total of 98 copies of questionnaires were administered to the respondents through purposive sampling, out of which 86 copies of questionnaires representing 87.76% response rate were retrieved and analysed using the mean score. The mean score for each item was determined and ranked. Furthermore, the significant levels of the items were determined using a 4.0 yardstick in line with earlier studies (Ikediashi and Okwuashi (2015); Ayodele (2017)). Items with mean scores higher than four were considered significant (SS), while those that have lower were deemed non-significant (NS). The variables were further analysed by thematic areas and ranked according to the themes' group mean. For the purpose of this study, weighted mean score is determined as follow:

$$\frac{1n_1 + 2n_2 + 3n_3 + 4n_4 + 5n_5 + 6n_6 + 7n_7}{N} \quad (i)$$

Where:

n1 = number of respondents who answered strongly disagreed.

n2 = number of respondents who answered disagreed

n3 = number of respondents who answered somewhat disagreed

n4 = number of respondents who answered undecided

n5 = number of respondents who answered somewhat agreed

n6 = number of respondents who answered agreed

n7 = number of respondents who answered strongly agreed

N = total number of questionnaires retrieved.

## RESULTS AND DISCUSSIONS

The results and discussions of the study are presented in this section and are twofold. The first part focuses on individual factors influencing estate management students' academic attainment (Table 2). As shown in Table 3, the factors influencing the academic attainment of estate management students based on thematic areas were examined in the second part.

**Table 2. Factors influencing the academic attainment of estate management students**

s/n	Factors	Mean	SD	Rank	Remark
	School factors/environment				
1	School's academic calendar	4.47	4.38	16	SS
2	Accommodation type/quality	4.34	5.30	19	SS
3	Conducive lecture halls	2.86	4.07	34	NS
4	Sufficient lecture halls	2.58	3.97	35	NS
5	School's overall environment	3.91	4.32	24	NS
6	Family set-up/ background	5.31	4.38	7	SS
	Teaching methods				
7	Integration of ICT into the classroom	2.93	3.10	33	NS
8	Student's participation in class	4.96	4.86	11	SS
9	Tutorials and seminars	3.66	3.76	27	NS
10	Excursions	3.37	3.47	32	NS
11	Contact hours	5.03	4.89	10	SS
12	Use of more practical than theories	3.74	3.85	26	NS
	Lecturers				
13	Scope and depth of the lecturers' knowledge	4.52	4.36	14	SS
14	Lecturers' accessibility	4.21	4.18	21	SS
15	Lecturers' commitment	5.26	5.07	8	SS
16	Lecturers' ability to clarify complex concepts	4.32	4.26	20	SS
17	Sufficiency/adequacy of lecturers	4.86	4.70	13	SS
18	Method/style of teaching	5.40	5.06	6	SS
19	Fairness in-class assessments	5.68	5.33	4	SS
20	Grades reflecting the effort expended in studying	5.73	5.33	3	SS
21	Adequate instruction materials	4.50	4.41	15	SS
22	Sufficient time to learn and assimilate before being tested	4.46	4.32	17	SS
23	The lecturers appear to be more concerned in testing what is memorised than what is genuinely understood	5.65	5.30	5	SS
	Students' Factors				
24	Inability to enrol in a desired course of study	3.82	3.92	25	NS
24	Age/ Maturity	4.94	4.76	12	SS
25	It is difficult to understand the courses that are being taught	4.17	4.12	22	SS
26	Study hours	3.62	3.70	28	NS
27	A thorough understanding of the field of study	4.12	4.12	23	SS
28	Passion for the course of study	5.80	5.41	2	SS
29	Participation in extra-curricular activities	3.56	3.61	30	NS
30	Parent's involvement in my studies	3.60	3.71	29	NS
31	Parents' occupations and educational backgrounds	4.44	4.31	18	SS
32	My position and the size of my family	6.02	5.59	1	SS
33	Availability of financial resources	5.09	4.91	9	SS
34	Family pressure to succeed in one's chosen course of study	3.55	3.65	31	NS
35	Family set-up/background	5.31	5.01	7	SS

Source: Analysis of survey data, 2020.

Table 2 reveals that 23 of the 35 individual factors were significant predictors of Estate Management students' academic attainment at a 4.0 benchmark. The five most critical factors influencing students' academic attainment are the respondents' position/size of the family and passion for the course of study. Others are grades being a reflection of the effort expended in studying, fairness in class assessments, and the lecturers appear to be more concerned in testing what is memorised than genuinely understood (mean values of 6.02, 5.80, 5.73, 5.68 and 5.65, respectively). The first two critical factors are related to parental/family background and students' factor. This finding is congruent to the position of Barry (2005), Bahar (2010) and Okioga (2013) that personal characteristics and socioeconomic background have a more significant effect on students' academic attainment. This result is not surprising given that it is widely assumed that most families' cultural and socioeconomic backgrounds put pressure on their children to succeed in their chosen field because it is perceived as a source of honour among family members and friends. As a result, students are under much pressure to satisfy this societal and cultural need. Furthermore, given the current state of affairs in Nigeria's higher educational institutions, the reason for the responses regarding students' interest in the course of study as a critical influencing factor may not be far-fetched. Many undergraduate students in Nigerian tertiary institutions find themselves studying courses they never intended to study or have a passion for. However, they find themselves in those courses/fields for a variety of reasons. Moreover, the other three factors indicated by the respondents are related to the assessment methods. Thus, students consider the method of assessment as a critical factor that impacts academic performance. This finding is consistent with the assertion of Rasul and Bukhsh (2011). While this may not be surprising, most students believe that their academic grades should reflect their efforts in preparation for the examination. However, according to Ayodele et al. (2017), students often overestimate their capabilities because they misjudge their examination performance. As a result, the actual results often differ from the students' expectations. This could be attributed to the implicit nature of the grading criteria adopted by lecturers for assessment. Students' opinions about assessment have a significant effect on how and what they understand. Hence, more comprehensive assessment methods that enable students to have prior knowledge of the grading process and the lecturer's expectations for each question will enhance students' academic success.

**Table 3. Influencing factors of estate management students' academic attainment (by thematic grouping)**

s/n	Thematic Groups	Group mean	Group rank
1	Parental/family background	4.67	3
2	Students' factors	4.29	4
3	School factor/environment	3.63	6
4	Teaching methods	3.95	5
5	Lecturers	4.74	2
6	Assessment methods	5.20	1

Source: Analysis of survey data, 2020.

According to Table 3, the results of influencing factors based on thematic categories showed that assessment methods, lecturers, and parental/family

background are the three most critical thematic categories that predict estate management students' academic attainment, with mean values of 5.20, 4.74, and 4.67, respectively. According to the respondents, this result also reveals that the most significant academic-based variables affecting students' academic success are the assessment methods and lecturers. Ayodele et al. (2017) discovered that assessment methods and lecturers were two of the top three themes that significantly affected Nigerian university students' academic success. This finding emphasises the importance of paying close attention to the lecturer's behaviour and expectations. Lecturers' attitudes are vital for successful teaching, and assessment is invariably a crucial factor in motivating students to learn. Consequently, the need for improved lecturers' attitudes and assessment strategies in higher education institutions cannot be over-emphasised. Lecturers are responsible for creating an environment that promotes learning activities relevant to achieving the desired outcomes. One crucial strategy is to use assessment to engage students. Making classroom experiences more engaging can also serve to pique students' interest in academic excellence, assisting them in improving their overall performance.

## CONCLUSION

This study was conducted to explore the significant factors that predict estate management students' academic attainment in a Nigerian polytechnic. The study examined 35 individual factors under the six thematic categories, including school factors, teaching methods, lecturers, assessment methods, students' factors, and parental/family background. The results revealed 23 out of the 35 individual factors as significant predictors of estate management students' academic attainment. Further analysis of these factors based on the thematic categories revealed that assessment methods, lecturers and parental background are the three most critical thematic categories that predict estate management students' academic attainment. The findings have some important implications for real estate education. There is a need for higher institutions to adopt a variety of lecturing and assessment policies to improve students' learning outputs. Grading standards should be made transparent and publicly accessible to promote the learning process and enhance academic outcomes. Students' anxiety will be reduced if they perceive the assessment as explicit and non-threatening. It is also critical to provide timely and accurate feedback that is related to the assessment indicators to promote students' engagement. Nonetheless, if students are not required to engage with the feedback, it will have little impact. As a result, activities that encourage students to reflect on their mistakes and better understand the lecturer's expectations must be developed. Lecturers' positive attitude combined with suitable teaching styles and regular and informative assessment feedback should significantly improve students' academic achievements.

## LIMITATIONS AND PATHWAY FOR FUTURE RESEARCH

This study only considered real estate students at one Polytechnic. Compared to existing related research, this study's sample size was relatively small (n= 86), making it difficult to generalise the findings to a larger student population and different programmes. Consequently, expanding the research to include a larger

sample size and participants from several academic institutions will strengthen the findings. Furthermore, future research could integrate more factors from academic institutions, individual students and socioeconomic dimensions to provide more detailed policy implementation outcomes.

## REFERENCES

- Adedapo, A. O., Aderonmu, P. A., & Aduwo, E. B. (2015), "Architecture students' perception of their learning environment and their academic performances", *Learning Environments Research*, Vol.18, pp. 129-142.
- Adediwura, A. A., & Tayo, B. (2007), "Perception of teachers' knowledge attitude and teaching skills as predictor of academic performance in Nigerian secondary schools", *Educational Research and Review*, Vol. 2 No. 7, pp. 165- 171.
- Allen, M. T., & Carter, C. C. (2007), "Academic success determinants for undergraduate real estate students", *Journal of Real Estate Practice and Education*, Vol. 10 No. 2, pp. 149-160.
- Akinbogun, S. P. (2018), "Admission into real estate undergraduate education in Nigerian Universities: the clog in the wheel", *Property Management*, Vol. 36 No. 3, pp. 358-371.
- Ayodele, T. O., Oladokun, T. T., & Gbadegesin, J. T. (2016), "Factors influencing academic performance of real estate students in Nigeria", *Property Management*, Vol. 34 No. 5, pp. 396-414. <http://dx.doi.org/10.1108/PM-09-2015-0045>
- Ayodele, T. O., Oladokun, T. T., & Oladokun, S. O. (2017), "Factors influencing real estate students' academic performance in an emerging economy: gender and socioeconomic perspectives", *Property Management*, Vol.35 (5), pp. 472-489. <https://doi.org/10.1108/PM-08-2016-0041>
- Bahar, H. H. (2010), "The effects of gender, perceived social support and sociometric status on academic success", *Procedia-Social and Behavioral Sciences*, Vol. 2 No. 2, pp. 3801-3805.
- Barry, J. (2005). *The effect of socioeconomic status on academic achievement*, Thesis, Wichita State University, KS
- Bennett, T. G., & Yalams, S. M. (2013), "Correlates of students' attendance to class, participation and performances in engineering modules," in *Global Engineering Education Conference (EDUCON)*.
- Chang, Y. (2010), *Students' Perceptions of Teaching Styles and Use of Learning Strategies*, Retrieved from: [http://trace.tennessee.edu/utk\\_gradthes/782](http://trace.tennessee.edu/utk_gradthes/782).
- Crews, G. L. (2004), "Real estate education on the run: the classroom comes to town", paper presented at the 10th Pacific Rim Real Estate Society Conference, Bangkok.
- Dahie, A. M., Mohamed, A. A., & BedelKhalif, H. (2017), "Examining factors affecting the quality of work life of lecturers: case study from university of Somalia in Mogadishu, Somalia", *International Journal of Advance Engineering and Research Development*, Vol. 4 No. 4, pp. 1117-1124.
- Dengra, M., Kalra, A., & Malhotra, G. (2013), "Study on factors affecting student quality of academic performance in colleges – with special reference to Indore", *Altius Shodh Journal of Management and Commerce*, Vol.2 No. 1, pp. 288- 94.

- Enu, J. A. O. K., & Nkum, D. (2015), "Factors influencing students' mathematics performance in some selected colleges of education in Ghana", *International Journal of Education Learning and Development*, Vol. 3 No. 3, pp. 68-74.
- Fan, W., & Williams, C. M. (2010), "The effects of parental involvement on students' academic self-efficacy, engagement and intrinsic motivation", *Educational Psychology*, Vol. 30, pp. 53-74. <https://doi.org/10.1080/01443410903353302>
- Gambo, Y. L., Osagie, J. U., Saliu, M. M., & Ogungbemi, A. O. (2012), "Student perception of career choice in estate management in Nigeria", *Global Journal of Management and Business Research*, Vol. 12 No 14, pp. 67-71.
- Ganyaupfu, E. M. (2013), "Factors influencing academic achievement in quantitative courses among business students of private higher education institutions", *Journal of Education and Practice*, Vol. 4 No. 15, pp. 57-65.
- Gajghat, R. H., Handa, C. C., & Himte, R. L. (2017), "Factors influencing academic performance of the students at university level exam: a literature review", *International Journal of Research in Engineering and Technology*, Vol. 6 No. 5, pp. 102-110.
- Hayat, Y., Ali, W., Hayat, S., Rahman, A., Shahzad, S., & Hussain, Z. (2013), "Studying behavior attributes and student's academic performance", *Sarhad Journal of Agriculture*, Vol. 29 No. 3, pp. 461- 467.
- Hijaz, S. T., & Naquiv, S. M. M. (2006). "Factors affecting students' performance: a case of private colleges", *Bangladesh e-Journal of Sociology*, Vol. 3 No. 1, pp. 90-100.
- Huffman, F. (2011), "Student performance in an undergraduate advanced real estate course: real estate majors vs. finance majors", *Journal of Real Estate Practice and Education*, Vol. 14 No. 2, pp. 111-124.
- Ikediashi, D., & Okwuashi, O. (2015), "Significant factors influencing outsourcing decision for facilities management (FM) services: a study of Nigeria's public hospitals", *Property Management*, Vol. 33 No. 1, pp. 59-82.
- Kamau L. M. (2013), *Relationship between family background and academic performance of secondary schools' students: a case of Siakago division, Mbeere north district, Kenya. Master Thesis, University of Nairobi, Nairobi, Kenya.*
- Kanagi, R., Tan, C. H., Sarimila, K., Lim, K. S., Haslina, K., & Dariush K. (2015), "Factors affecting first year undergraduate students' academic performance", *Scholars Journal of Economics, Business and Management*, Vol. 2 No. 1A, pp.54-60.
- Kang'ahi, M., Indoshi, F. C., Okwach, T. O., & Osido, J. (2012), "Teaching Styles and Learners' Achievement in Kiswahili Language in Secondary Schools", *International Journal of Academic Research in Progressive Education and Development*, Vol. 1 No. 3, pp. 62-87.
- Kyoshaba, M. (2009), "Factors affecting academic performance of undergraduate students at Uganda Christian university", *Dissertation, graduate school Makerere University, Kampala.*
- Laurel, W. K., Wong, T. A., Chan, Y. H., & Safiyyah, S. R. (2008), "Psychological factors in academic performance among college students", *Educational Assessment*, Vol. 8 No. 3, pp. 207-229.
- Lee, C. L., & Mallik, G. (2015), "The impact of student characteristics on academic achievement: findings from an online undergraduate property program", *Pacific Rim Property Research Journal*, Vol. 21 No. 1, pp. 3-14.

- Mushtaq, I., & Khan, S. N. (2012), "Factors affecting students 'academic performance", *Global Journal of Management and Business Research*, Vol. 12 No. 9, pp. 16-22.
- Muzenda, A. (2013), "Lecturers 'competences and students 'academic performance", *International Journal of Humanities and Social Science Invention*, Vol. 3 No. 1, pp. 6-13.
- Newell, G., & Acheampong, P. (2003), "The quality of property education in Australia", *Pacific Rim Property Research Journal*, Vol. 9 No. 4, pp. 361-378.
- Noble, J. P., Roberts, W. L., & Sawyer, R. L. (2006), "Student achievement, behavior, perceptions, and other factors affecting ACT scores", *ACT Research Report series*.
- Ojetunde, I., Sule, A. I., Kemiki, O. A., & Olatunji, I. A. (2020), "Factors affecting the academic performance of real estate students in a specialised Federal University of Technology in Nigeria", *Property Management*, Vol. 38 No. 2, pp. 177-198. DOI:10.1108/PM-08-2019-0044
- Okioga (2013), "The impact of students' socioeconomic background on academic performance in universities", *American International Journal of Social Science*, Vol. 2, No. 2, pp. 38-46.
- Oladokun, T. T., & Ayodele, T. O. (2015), "Students 'perception of the relevance of work experience scheme to real estate education in Nigeria", *Property Management*, Vol. 33 No. 1, pp. 4 – 18.
- Olatunji, S. O., Aghimien, D. O., Emmanuel, A., & Olushola, O. E. (2016), "Factors affecting performance of undergraduate students in construction related disciplines", *Journal of Education and Practice*, Vol. 17 No. 3, pp. 55-62.
- Oloyede, S. A., & Adegoke, O. J. (2007), "Relevance of real estate education to practice in Nigeria", *Journal of Land Use and Development Studies*, Vol. 3 No.1, pp. 50–59.
- Peter, N. J., Ayedun, C., Oloyede, S., Adedamola, O. O., Oluwatobi, F., & Emeghe, I. J. (2016), Gender perspective in students 'performance in real estate education: the case of Covenant University students, Ota Nigeria. *Proceedings of ICERI Conference, 14th-16th November, Seville, Spain*, pp.7539-7545.
- Rasul, S., & Bukhsh, Q. (2011), "A study of factors affecting students 'performance in examination at university level", *Procedia-Social and Behavioral Sciences*, Vol. 15, pp.2042-2047.
- Victor, M. (2011), "An analysis of some factors affecting student academic performance in an introductory biochemistry course at the University of the West Indies", *Caribbean Teaching Scholar*, Vol. 1 No. 2, pp. 79-92.
- Yam, S., & Rossini, P. (2012), "Online learning and blended learning: experience from a first-year undergraduate property valuation course" *Pacific Rim Property Research Journal*, Vol. 18 No. 2, 129-148.
- Yeshimebrat, M., Alemayehu, B., & Firew, T. (2013), "Factor affecting female students ' achievement at Bahir Dar university, Ethiopia", *Journal of International Cooperation in Education*, Vol. 15 No. 3, pp. 135-148.
- Zakaria, Z., Kassim, R. A., Mohamad, A., & Buniyamin, N. (2011). The impact of environment on engineering students' academic performance: a pilot study, in *Engineering Education (ICEED) 3rd International Congress*.



# RESPONSIBLE MATERIAL SOURCING: AN ASSESSMENT OF FACTORS INFLUENCING CONSTRUCTION MATERIAL SUSTAINABILITY

Nana Benyi Ansah<sup>1</sup>, Emmanuel Adinyira<sup>2</sup>, Kofi Agyekum<sup>3</sup> and Isaac Aidoo<sup>4</sup>

<sup>1,2,3,4</sup>*Department of Construction Technology and Management, College of Art and Built Environment, Kwame Nkrumah University of Science and Technology (KNUST), Kumasi, Ghana*

The term “responsible materials” refers to products that have been certified as meeting sustainability standards. Thus, the ethical management of sustainability challenges in the construction product supply chain is referred to as responsible sourcing. It encourages the appropriate availability of measurements that increase sustainability by assessing the environmental impact of materials in the construction supply chain. Due to its health implications, environmental pollution caused by material sourcing and usage has been a hot topic of investigation. Construction specialists responsible for selecting materials with low environmental footprints have a tough time doing so. In addition to the obstacles faced by essential specialists in material selection, numerous aspects must be considered in the sourcing and selection processes, such as comparing policies, to result in better material usage beginning with the design phase. This research is aimed at assessing the factors that influence material sourcing in the construction industry in which sustainability is promoted. A survey of Ghanaian construction professionals involved in the selection and procuring of construction materials was conducted. The variables were evaluated based on the mean of their ratings. All of the variables deemed to influence responsible sourcing of construction materials were subjected to a principal component analysis (PCA). PCA found four components with eigenvalues greater than one, accounting for 34.2 per cent of environmental criteria, 12.10 per cent of resource consumption criteria, 8.4% of technological criteria, and 6.9% of socio-economic criteria. As a result, all of the variables were significant, confirming the conclusions of the literature. Despite being considered an essential factor, eutrophication earned the lowest rating in the environmental factor category; this is a cause for concern in ecosystem management. The study contributes to the management of material sustainability in the Global South to promote the required material sourcing and selection response from decision-making professionals.

Keywords: global south, material sustainability, responsible material, responsible sourcing

---

<sup>1</sup> nbenyi@yahoo.co.uk

<sup>2</sup> rasadii@yahoo.com

<sup>3</sup> agyekum.kofi1@gmail.com

<sup>4</sup> iaideo@gmail.com



## INTRODUCTION

The term “responsible materials” refers to products that have been certified as meeting sustainability standards. Thus, the ethical management of sustainability challenges in the construction product supply chain is referred to as responsible sourcing. It encourages the appropriate availability of measurements that increase sustainability by assessing the environmental impact of materials in the construction supply chain. Due to its health implications, environmental pollution caused by material sourcing and usage has been a hot topic of investigation. Van den Brink et al. (2019) emphasise that one of the most significant concerns linked with urbanisation has been environmental sustainability, mainly where raw materials or products are obtained from sources with regulatory limitations. Raw material resources are used to meet the rising demand for construction materials all around the world. However, construction specialists responsible for selecting materials with low environmental footprints have a tough time doing so (Mesa et al. 2020; Pacheco-Torgal and Jalali 2011). This has resulted in the adoption of several materials that have been certified but have a high environmental impact, necessitating more research. The general challenge is that poor material sourcing results in heavy environmental burdens.

Environmental implications are largely fixed once the materials for each component are established because material selection occurs during the product design phase. Since material selection impacts product performance, higher selection standards are required to maintain quality and value. There is little doubt that when materials are appropriately procured following established regulations and norms, environmental loads from construction materials will be decreased, making the environment safer and enhancing sustainability. In addition to the obstacles faced by essential specialists in material selection, numerous aspects must be considered in the sourcing and selection processes, such as comparing policies, to result in better material usage beginning with the design phase (Lee et al., 2020; Xu et al., 2020; Akadiri et al. 2013).

When exploring the relationship between material sourcing and sustainability, the modest positive influence will add to the total amount of sustainability gain necessary. According to (Lassio et al., 2016), the high demand for construction materials depends on raw materials. However, Pacheco-Torgal and Jalali (2011) explain that construction professionals have difficulty determining materials with environmental hot spots, which has led to the use of several materials with heavy environmental burdens worthy of attention. Therefore, this research aims to assess the factors that influence material sourcing in the construction industry in which sustainability is promoted.

According to Paquette (2006), the environmental impacts of specific materials, products and activities in the construction supply chain need to be closely monitored. Furthermore, their influence on the environment has to be proactively handled. The study of material sourcing based on provenance is a significant factor that gravitates the professional to using a particular material. According to Wilson (2007), the gravity model for selecting and procuring material based on provenance enables one to decide where to acquire their needs based on the

likelihood of attraction to the source; this has been a significant economic module for material selection.

In his study on selecting sustainable materials for building projects, Akadiri (2011) argued that, historically, the object of evaluating the building construction material was to use the one with the least cost to the client. However, there were no consideration for origin, environmental protection and performance characteristics. When procuring materials and goods in most industrialised countries, the government needs contractors to think carefully about a range of environmental, economic, and social challenges. Again, the Global South's immature markets imply a lack of understanding of the industry's responsible sourcing (Glass, 2011). In the context of sustainability, Glass (2011) proposed that responsible sourcing (R.S.) provides the pathway to resolve the challenges associated with the supply chain of construction materials.

## **CONTEXT**

Contextually, the study will help understand whether the factors on which decision-making construction professionals use in the Global South to procure materials are relevant to theory. Upstill-Goddard et al. (2015) report that the literature on responsible sourcing remains scarce. The traceability of material content and the ethical transparency needed for material sourcing have not been sufficiently evaluated. In order to direct the sustainability agenda on material origin, Glass et al. (2012) documented the lack of research awareness within industry and academia to promote the responsible sourcing drive to enhance material sustainability. "It is obvious that while qualification schemes abound, there is no indication of the current level of expertise and awareness", Glass et al. (2012) declared. The study, therefore, included information on factors and the criteria that enable the available materials to be responsibly sourced based on provenance.

## **RESPONSIBLE SOURCING DEFINED**

According to Ramchandani et al. (2020), stakeholders have become more aware of the social and environmental consequences of a company's operations in recent years; even if a single product (material) is successfully certified, the certifying brand may benefit from favourable knowledge-based spillovers that encourage responsible sourcing across its entire product line. According to van den Brink et al. (2019), there are three definitions for responsible sourcing that have been used in recent years. The first from the British Standard Institute defines responsible sourcing as "the management of sustainable development in the provision or procurement of a product" (BRE Global, 2016). Second, Upstill-Goddard et al. (2015) define responsible sourcing as the "management of sustainability issues associated with materials in the construction supply-chain, often from an ethical perspective" Young and Osmani (2013) argue that the scope of responsible sourcing is within materials supply. The fourth definition van den Brink et al. (2019) failed to recognise is the argument made by Glass (2011), in which responsible sourcing was defined as the "procurement of products certified against sustainability criteria".

The practices of responsible sourcing and responsible procurement have a common ground. Van den Brink et al. (2019) argues that responsible procurement focuses more on monitoring relations with suppliers while responsible sourcing insists on production data. Table1 shows the basic delineations.

**Table 1 “Responsible sourcing” versus “Responsible procurement”**

Type	Objective	Approach
Responsible sourcing	Managing the sustainability (social, environmental and/or economic) of the supply chain	Via production
Responsible procurement	Managing the sustainability (social, environmental and/or economic) of suppliers	data

Source: (Van den Brink et al., 2019)

## **FACTORS THAT INFLUENCE MATERIAL SOURCING**

According to the International Trade Organisation (2020), Ghana’s construction industry was worth 18 billion dollars in 2018 and accounted for 18.8 per cent of the country’s GDP in that year. This value implies that the construction sector’s material economy cannot be underestimated since it plays a substantial role in constructing construction projects. Wilson (2007) categorised the factors for selecting material from the source as being geographic or geologic. However, in their consideration, the environmental sustainability of the source was not a significant criterion. Adjarko et al. (2015) carried out a study on incorporating environmental sustainability into construction procurement, in which several factors were suggested. The top four among these factors were leadership skills, environmental culture, public influence and personal skills. However, it is worth noting that the material source was not considered an environmental factor during the material procurement. Therefore, to achieve a holistic, sustainable material procurement, the source and the knowledge of those in a position to influence the choice of material selection need to be considered.

### **Environmental consideration**

A study carried out by Pacheco-Torgal and Jalali (2011) and Levin (2016) indicated that the difficulty of determining the pattern of toxins emitted from building construction materials by the built environment professional has led to the use of several toxic materials which are worthy of attention. Some of these materials are legally accepted, yet they contain some form of toxicity. The material itself may not be toxic, but the processes of obtaining the materials may contain certain environmental negativities, and this may be attributed to the material in question. Thus, environmental assessment of building materials is needed to substitute those prone to sustainability ramifications with more environmentally friendly ones to deliver sustainable building construction projects (Farahzadi et al., 2016). Ruuska and Häkkinen (2014) suggest that since natural resources support the quality of life, there is the need to procure materials responsibly to create products and services with lesser resources and environmental impacts. In their study on the assessment of CO<sub>2</sub> in selecting construction materials (using three live construction projects), González and Navarro (2006) found and concluded that the careful selection of building materials with environmental considerations reduces carbon emissions.

### Technological consideration

Material selection and/or sourcing technology considerations include durability (design, production, and reprocessing). Lifset and Eckelman (2013) and Levin (2016) all supported the principle of material longevity. In his plenary Architecture lecture, Levin (2016, p.15) demonstrated that “selecting natural building materials that are robust has sufficient environmental benefits than the one that must be substituted more than once in the life of the building.” For example, increasing the concrete cover from 10mm to 20mm doubles the service life of reinforcement (defined as the time it takes carbonation to enter the reinforcement, Levin (2016, p.63) by 400% but increases concrete consumption only 5-10%. Therefore, in responsible sourcing of construction materials, the source model that provides a better and more durable material should be considered since it will contribute to the material sustainability agenda.

The design for durability has been the strategy in the circular economy. In their study on developing an indicator for material selection Mesa, et al. (2020) posited, durability reduces the frequency of construction material maintainability.

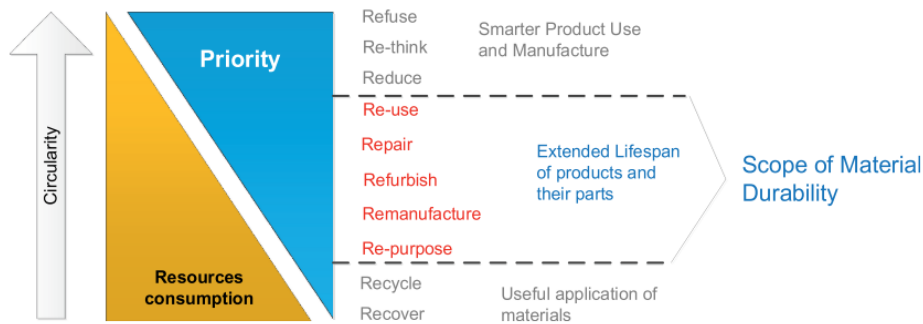

The Concept of Durability after Mesa et al. (2020)

### Resource consumption

There is no doubt that the building construction industry requires much energy regularly. Liedtke et al. (2014) asserted that in the development and consumption of various systems, such as lifecycle stages, processes, production, transportation, and energy usage, these are all indicators that contribute to resource management through the economic management framework. Furthermore, according to Xu et al. (2020), natural resource extraction and processing are responsible for more than 90% of biodiversity loss and systemic ecosystem depletion. As a result, resource consumption is just as crucial as the contributing factors in the responsible sourcing of construction materials to promote material sustainability.

### Social considerations

Social considerations in responsible material sourcing are understood as the impacts on human well-being, human capital, cultural heritage and social behaviour (Chhipi-Shrestha et al., 2015). Sourcing material responsibly relates to human well being as it relates to material consumption. A study conducted by Hosseinijou et al. (2014) found that it is essential for society to benefit from using construction materials. It is essential to improve the eco-efficiency of material production and develop mechanisms that would promote materials recovery with low environmental considerations during deconstruction. A study between steel

and concrete concluded that steel has a better social impact than concrete. To support product and material policies, (JRC Technical Report by the European Commission, 2014) suggests a need to incorporate life cycle assessment to examine the environmental implications from raw material extraction to product end-of-life. The Life cycle assessment coupled with socio-economic analysis may support a more comprehensive study. Hence it is essential to integrate the social life cycle into the supply chain of construction materials.

## RESEARCH METHODOLOGY

This research aimed at assessing the factors that influence material sourcing in the construction industry in which sustainability is promoted. For the aim to be achieved, the following objectives were set:

1. to estimate the perceived level of consideration of factors for material responsible sourcing;
2. to determine whether the factors considered in responsible sourcing of construction materials in Ghana fit standard factors provided in the literature.

A quantitative research approach was used. This approach is widely associated with the positivism research stance (Saunders et al., 2019). It also allows using a structured research questionnaire to enable the study to generalise the findings from the sampling methods applied.

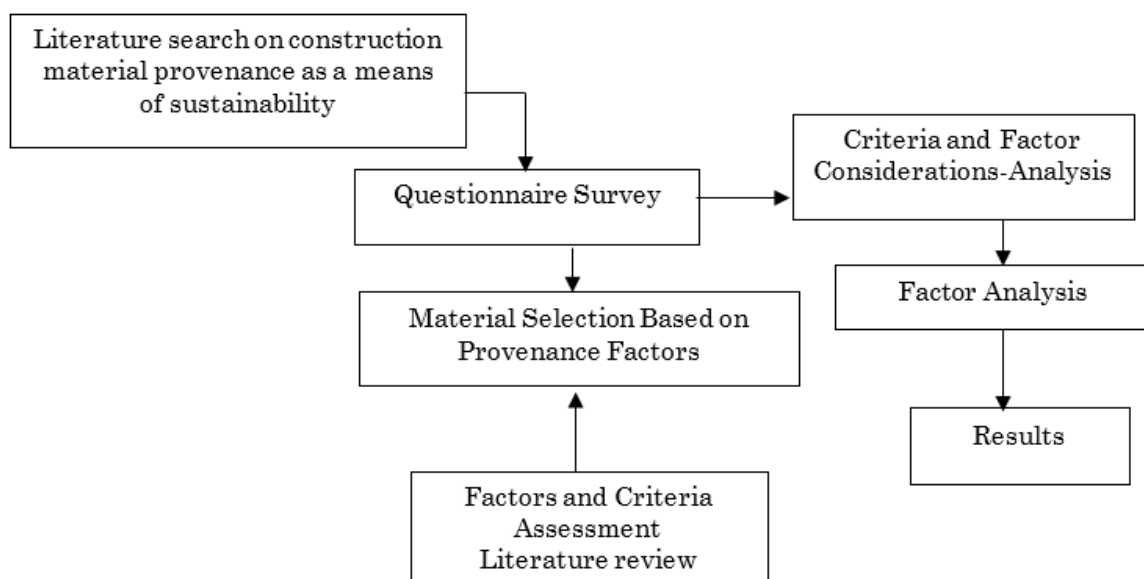

Figure 1: Research Framework and Methodology

### Population and sample size

The unit of analysis (the focus of study) from which the data was collected was the construction industry. The unit of observation from which data was measured to understand the construction industry's material selection practices was the decision-making of construction professionals in selecting and procuring construction materials in Ghana. Accra, the capital and the construction hub of Ghana, was selected for the study since most of the identified decision-making professionals work in this city. The emphasis was that; these practitioners have a

reasonably high degree of experience in construction material selection. Accordingly, this identification made the study homogenous (Saunders et al. 2019). A survey of Ghanaian Construction professionals in selecting building materials was conducted through the Google form platform to obtain the relevant factors required in the study.

According to Rowley (2014, p. 319), purposive sampling should be used when some cases are identified and likely yield the most valuable results. The non-probability sampling used was purposive and snowball. Purposive because some of the decision-making professionals were known. Therefore, the questionnaire was circulated through the Google form platform (snowball) to their colleagues in the same category (homogeneity) who volunteered to participate in the research. However, there was no clear way of constructing a sampling frame from which a generalisation could be deduced. The rule for employing the non-probability sampling technique, according to Saunders et al. (2019 p.315), is unclear and hence becomes judgemental. It is thus dependent on what is required and the resources available. Using this premise from Saunders et al. (2019), 58 construction professionals were interviewed from 52 organisations using the non-probability sampling method. Pesämaa et al. (2021 p.219) argue that a study's realism is enhanced when the respondents are taken from knowledgeable informants and the sample size is representative and compatible with the study. This argument was consistent with the study.

**Inclusion and Exclusion Criteria**

Altogether 58 responses were received through the purposive and snowball sampling methods used. Six of the 58 respondents were discovered to work for the same organisation. In addition, those who work in the same organisation but provided the first responders were included using the dates (Timestamp) for the responses (and those who gave their responses later were excluded). This criterion ensured that a single expert delivered the required response from a single organisation.

**Table 2: Exclusion and inclusion criteria**

Questionnaire Distribution			
Population	Response Received	Response From same organisation	Valid Response
Undefined	58	6	52

**Data collection**

Data collection improves theoretical comprehension in a research sample. A questionnaire adapted from Akadiri's (2011) research was used to collect data. An ethical response form was provided to ask respondents to freely agree or disagree to participate in the study, allowing them to opt-out during the survey. The questionnaire was divided into two parts. Section A tried to learn about the respondents 'backgrounds. The bulk of the questions in section B were on a Likert-Scale scale of 1 to 5. Section B's questions focused on the factors perceived to influence responsible construction material sourcing based on provenance, obtained from literature thus; environmental criteria, technical criteria, resource

use and socio-economic criteria, all concerning the provenance (source) of construction material procurement and use.

### Summary

A longitudinal study might trigger an experimental design to obtain the underlying factors from primary analysis instead of literature. Thus, the longitudinal study would shed further light on the data. In addition, it would be fascinating to conduct a study that compared primary and secondary data analysis findings. Finally, even though the number of respondents is adequate, a larger sample size would allow better generalisation. From Table 2, The exclusion and the inclusion criteria were used to prevent repeated measurements from the same company to ensure the relevance of the results.

## ANALYSIS AND RESULTS

In this section, the analysis and results are presented on the two specific objectives of the study, the first of which is to estimate the perceived level of consideration of factors for responsible material sourcing concerning provenance. The second objective is to determine whether factors considered in responsible sourcing of materials in Ghana are consistent with factors provided in the literature. Table 3 shows the descriptive statistics on the professional characteristics of respondents. The specific attributes considered are company age, position, and work experience.

**Table 3: Participant characteristics**

Variable	Group	Frequency/Mean	Per cent/SD
Company age	< 5 yrs	6	12%
	6-10 yrs	7	13%
	11-20 yrs	21	40%
	21-30 yrs	9	17%
	31-40 yrs	7	13%
	> 40 yrs	2	4%
	Total	52	100%
Position	Engineer	12	23%
	Project Manager	13	25%
	Quantity Surveyor	5	10%
	Contractor	6	12%
	Procurement Officer	3	6%
	Project Coordinator	4	8%
	Others	9	17%
Total	52	100%	
Work experience	---	12.17	6.59

Note: Mean and standard deviation apply to only work experience

It can be seen that 12% (n = 6) of participants 'organizations were less than 5 years, 13% (n = 7) had between 6- and 10-years 'experience as well as 31 to 40 years, 40% (n = 19) had between 11and 20 years, 17% (n = 9) had between 21 and 30 years, and 4% (n = 2) had more than 40 years 'work experience. About 23% (n = 12) of the participants were engineers, 25% (n = 13) were project managers, 10% (n = 5)

were quantity surveyors, 12% (n = 12) were contractors, 6% (n = 3) were procurement offices, 8% (n = 4) were project coordinators, and 17% (n = 9) belonged to other categories. Finally, the average years of work experience of respondents was 12 years (Mean = 12.17; SD = 6.59). Thus, participants were adequately experienced in the subject matter concerned.

**Table 4: Descriptive statistics showing the extent of consideration of criteria and factors**

Criterion/factor	N	Min	Max	Mean	SD	% of mean
Material quality due to source	52	3	5	4.79	0.50	96%
Material harvest or extraction	52	2	5	3.88	1.00	78%
Zero or low toxicity	52	1	5	4.25	0.86	85%
Ozone Depletion Potential	52	1	5	3.77	1.10	75%
Impact of material on air quality	52	2	5	4.10	0.93	82%
Potential for recycling and re-use	52	1	5	4.04	1.10	81%
Global warming potential	52	2	5	3.90	1.07	78%
Acidification Potential	52	1	5	3.48	1.16	70%
Eutrophication Potential	52	1	5	3.46	1.07	69%
Environmental statutory compliance	52	2	5	4.33	0.81	87%
<b>ENVIRONMENTAL</b>	52	28	50	40.00	6.51	80%
Maintainability	52	3	5	4.46	0.75	89%
Sound insulation	52	1	5	3.94	1.04	79%
Resistance to decay	52	1	5	4.38	0.97	88%
Fire resistance	52	3	5	4.67	0.58	93%
Life expectancy of material (e.g. strength, durability)	52	3	5	4.40	0.66	88%
<b>TECHNOLOGICAL</b>	52	15	25	21.87	2.87	87%
Embodied energy	52	2	5	4.12	0.81	82%
Availability	52	3	5	4.50	0.67	90%
Methods of extraction of raw material	52	1	5	3.90	1.11	78%
Likely waste in the use of material	52	1	5	3.92	1.17	78%
Transportation required	52	2	5	4.08	0.86	82%
<b>RESOURCE CONSUMPTION</b>	52	14	25	20.52	2.92	82%
Life cycle cost (initial, maintenance, and repair cost)	52	2	5	4.17	0.76	83%
Health and safety	52	3	5	4.63	0.53	93%
Ease of construction/ buildability	52	3	5	4.56	0.64	91%
Aesthetics	52	2	5	4.33	0.79	87%
<b>SOCIO-ECONOMIC</b>	52	13	20	17.69	1.85	88%

Note: factors are in block letters; S.D. – standard deviation; Min. – minimum; Max– maximum

Since the Likert scale used to measure the criteria and factors was associated with a five-point descriptive anchor representing a continuum (i.e. least crucial to extremely important), the mean scores in Table 4 represent the levels of consideration of the criteria and factors. In this regard, more significant mean



scores indicate higher consideration of the criteria or factors and vice versa. In Table 4, the minimum and maximum scores of the criteria are 1 and 5, respectively. The four factors in the table (i.e. environmental, technological, resource use, and socio-economic) were developed by summing up the relevant items used to measure the factor. The resulting data is, thus, an index of the factors.

The minimum and maximum scores of the factors or indices are the sums of all minimum and maximum values of the relevant criteria. Thus, the higher the mean score of a criterion or factor, the higher the perceived level of consideration in responsible material sourcing. If so, it can be seen that all criteria in the table have a large mean score.

Among the environmental criteria, "Material quality due to source" has the largest mean score (Mean = 4.79; SD = 0.5), representing 96% of the maximum score of 5. That is, this criterion is the most important among the environmental criteria and other factors. In Table 3, the least important factor is "Eutrophication Potential" (Mean = 3.46; SD = 1.07), which is under the environmental factor. It accounts for 69% of the maximum score of 5, which means it is above average and can be considered a sufficiently important criterion. Environmental as a factor accounts for a mean score of about 40 (Mean = 40.00; SD = 6.51), representing about 80% of the maximum scale score of 50. Technological factors account for a mean score of about 22 (Mean = 21.87; SD = 2.87), representing about 87% of the maximum scale score. It can be seen those Technological accounts for the second-largest percentage among the factors, which means it is the second most important among the factors. The most important and applied factor is socio-economic, which accounts for a percentage score of 88%. It can be seen that the factor with the smallest percentage is environmental, which connotes that this factor is the least applied or considered, though one of its items is the most considered criterion.

With the above result, all criteria and factors were considered in Ghana in responsible sourcing of materials. Table 5 shows the results of a one-sample t-test, which assesses whether the mean scores of the factors are more significant than the median score of the factors. If the mean score is significantly greater than the median score, then it can be said that the extent of consideration of the factor is above average and appreciable.

**Table 5: The one-sample t-test**

Factor	Test value	t	df	p	Mean Difference	95% CI
Environmental	30	11.075	51	0.000	10.00	±3.63
Technological	15	17.25	51	0.000	6.87	±1.60
Resource Consumption	15	13.628	51	0.000	5.52	±1.63
Socio-economic	12	22.154	51	0.000	5.69	±1.03

Note: Test values are the median of the variable; CI – confidence interval

In Table 5, the test value is the median score corresponding to the factor. The test focuses on finding out if the mean scores of Table 5 are greater than these corresponding medians or test values. In Table 5, it can be seen that all the factors account for a positive mean difference, with environmental accounting for the

largest mean difference of 10. This result indicates that deducting the test value from the mean gives a positive result, which connotes that the mean scores are greater than their corresponding medians. For each factor, the t-test is significant at  $p < 0.001$ . For example, the t-test of environmental is significant at  $p < 0.001$  ( $t = 11.08$ ;  $p = .000$ ). Thus, the mean scores of the four factors are greater than their corresponding medians. Therefore, the level of consideration of the factors responsible for sourcing materials is above average — table 6 and 7 present findings on the second objective.

The Principal Component Analysis (PCA) was carried out on all the variables, as shown in Table 6. As a result, the total variance accounts for by the four-factor variables was 61.60% which meets the analysis requirements. Furthermore, the extraction values in table 5 show that the communality values were  $\geq 0.5$  (Kelava, 2016) and thus met the requirements in the literature.

**Table 6: Extraction values from principal component analysis after Varimax**

Criteria	Initial	Extraction
Material quality due to source	1	0.733
Material harvest or extraction	1	0.717
Zero or low toxicity	1	0.803
Ozone Depletion Potential	1	0.637
Impact of material on air quality	1	0.763
Potential for recycling and reuse	1	0.700
Global warming potential	1	0.872
Acidification Potential	1	0.758
Eutrophication Potential	1	0.793
Environmental statutory compliance	1	0.581
Maintainability	1	0.726
Sound insulation	1	0.517
Resistance to decay	1	0.871
Fire resistance	1	0.802
The life expectancy of material (e.g. strength, durability)	1	0.695
Embodied energy	1	0.675
Availability	1	0.801
Methods of extraction of raw material	1	0.692
Likely waste in the use of material	1	0.735
Transportation required	1	0.624
Life cycle cost (initial, maintenance, and repair cost)	1	0.739
Health and safety	1	0.633
Ease of construction/ buildability	1	0.640
Aesthetics	1	0.675

Note: Kaiser-Meyer-Olkin (KMO) Measure = 0.658; df = 300; Ch-square; 936.24;  $p = 0.000$

Extraction values in Table 6 are communality values that must each meet the condition:  $\text{communality} \geq 0.5$  (Kelava, 2016). Any criterion that meets this condition is considered part of the standard variables in responsible material sourcing from the literature. It can be seen that all the criteria met this condition. This means that all the standard criteria considered at the international level underpin the Ghanaian context. Beneath Table 6, the Kaiser-Meyer-Olkin (KMO) value of the factor analysis

is about 0.658, whereas the Chi-square test is significant at  $p < 0.001$ . These results are satisfactory and suggest that the model is random (Kelava, 2016).

**Table 7: Factor loadings, variance, and eigenvalues**

Component	1	2	3	4
Variance (Total = 61.58%)	34.19	12.07	8.43	6.89
Eigenvalue	8.55	3.02	2.11	1.72
Material quality due to source	0.84			
Material harvest or extraction	0.65			
Zero or low toxicity	0.48			
Ozone Depletion Potential	0.70			
Impact of material on air quality	0.63			
Potential for recycling and reuse	0.47			
Global warming potential	0.77			
Acidification Potential	0.59			
Eutrophication Potential	0.83			
Environmental statutory compliance	0.60			
Concrete			0.91	
Maintainability			0.66	
Sound insulation			0.46	
Resistance to decay			0.89	
Fire resistance			0.64	
The life expectancy of material (e.g. strength, durability)		0.61		
Embodied energy		0.58		
Availability		0.73		
Methods of extraction of raw material		0.43		
Likely waste in the use of material		0.41		
Transportation required				0.53
Life cycle cost (initial, maintenance, and repair cost)				0.57
Health and safety				0.62
Ease of construction/ buildability				0.76
Aesthetics				0.64

Note: factor 1 – Environmental; factor 2 = Resource Consumption; factor 3 – Technological; factor 4 – socioeconomic

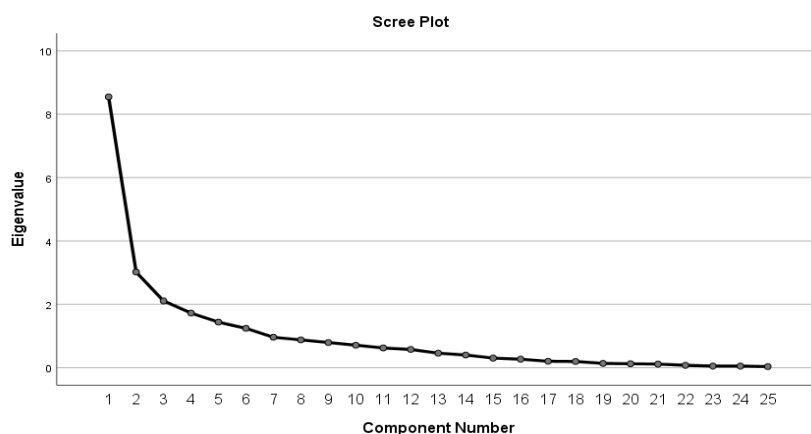

Figure 2: A scree plot (source: Field Survey 2021) showing factors extracted

Table 7 shows the factor loadings of four factors extracted. The total variance extracted and eigenvalues are also reported. The total variance accounted for by the four factors is 61.6%, which is satisfactory. The factor loadings of each factor meet the condition: factor loading  $\geq 0.5$ , which affirms results on the communalities. Every criterion recognised by literature at the international level is considered as part of the factors analysed. The first factor is 'environmental', which accounts for a variance of about 34.2%. The second factor is 'resource consumption', which accounts for 12.1% of the total variance. The third and fourth factors are 'technological' (variance = 8.4%) and 'socio-economic' (variance = 6.9%) respectively. Figure 2 is a scree plot showing factors extracted from the factor analysis.

Twenty-four (24) factors were identified from the literature. After performing exploratory factor analysis (EFA) with varimax rotation and principal components extraction, eigenvalues  $\geq 1$  were retained; thus, 4 factors (i.e. Environmental, Technological, Resource Consumption and Socio-economic) were extracted. The scree plot confirms this. The four factors accounted for 61.60 per cent of the total variance, which met the analysis requirements. Table 6 shows that the communality values were less than 0.5, which matched the conditions in the literature. The varimax approach was used in the principal component extraction since it makes factor interpretation easier (Kelava 2016).

Tables 8–11 show a comparison of criteria derived from fieldwork and literature with the study's findings.

**Table 8: Environmental criteria**

Environmental	Mean	SD	Rank (Field Study)	Rank (Literature)	Level of Importance
Material quality due to source (Durability)	4.79	0.5	1	3	H
Environmental statutory compliance	4.33	0.81	2	1	M-H
Zero or low toxicity	4.25	0.86	3	3	M-H
Impact of material on air quality	4.10	0.93	4	9	M-H
Potential for recycling and re-use	4.04	1.1	5	5	M-H
Global warming potential	3.9	1.07	6	6	M-H
Material harvest or extraction	3.88	1	7	11	M-H
Ozone Depletion Potential	3.77	1.10	8	4	M-H
Acidification Potential	3.48	1.16	9	N/A	N/A
Eutrophication Potential	3.46	1.07	10	N/A	N/A

**Table 9: Technological criteria**

Technological	Mean	SD	Rank (Field Study)	Rank (Literature)	Level of Importance
Fire resistance	4.67	0.58	1	4	H
Maintainability	4.46	0.75	2	1	H
Life expectancy of material (e.g. strength)	4.4	0.66	3	2	H
Resistance to decay	4.38	0.97	4	6	M-H
Sound insulation	3.94	1.04	5	2	M

**Table 10: Resource consumption criteria**

Resource Consumption	Mean	SD	Rank (Field Study)	Rank (Literature)	Level of Importance
Availability	4.50	0.67	1	7	M-H
Embodied energy	4.12	0.81	2	7	M-H
Transportation required	4.08	0.86	3		
Likely waste in the use of material	3.92	1.11	4	6	M-H
Methods of extraction of raw material	3.90	1.17	5	11	M-H

**Table 11: Socio-economic criteria**

Socio-Economic	Mean	SD	Rank (Field Study)	Rank (Literature)	Level of Importance
Health and safety	4.63	0.53	1	3	H
Ease of construction/buildability	4.56	0.64	2	5	H
Aesthetics	4.33	0.79	3	1	H
Life cycle cost (initial, maintenance, and repair cost)	4.17	0.76	4	2	H

H=high, M= medium, N/A = Not Applicable

Source: Field study (2021); Lee et al., (2020); Baglou et al. (2017) Akadiri et al. (2013); Akadiri and Olomolaiye (2012) Akadiri (2011)

Tables 8-11 confirm and validate the study's result with the factors obtained from the literature. Thus, even though the methodology used in the study was different from that found in literature, with the above result, all criteria and factors considered in Ghana in responsible sourcing of materials sourcing were relevant to literature.

## DISCUSSION

No matter how small the benefits would be, responsible sourcing will add to the aggregation of the sustainability positives in the construction sector. It is thus one path of ensuring that the three fronts of sustainability are achieved in the construction industry. The subject of responsible sourcing is relatively new and lacks adequate literature resource. However, about a third of the available literature in the recent past years has come from the construction industry (Van den Brink et al., 2019). Though the focus has been on construction, there is a gradual development from other sectors as well. The emerging development of sustainability schemes and growing concern of responsible sourcing indicate it is gradually receiving the needed theoretical and practical attention.

However, a lack of transparency makes responsible sourcing challenging. It requires visibility, transparency and sound functioning legislation through the supply chain. In addition, firms need to develop high ethical standards from production through supply to realise the required material sourcing responsibility. A few research studies in the Global South (if any) have examined the subject of responsible sourcing. This study fills the gap by looking at the factors considered

in responsible sourcing and the likely environmental impact at the material origin. It, therefore, provides a basis for future research, especially in the Global South.

## CONCLUSION

This study has estimated the perceived level of consideration of standard factors for responsible material sourcing and procurement based on provenance and determined whether the perceived factors were consistent with factors found in the literature. A total of 4 group factors altogether having 24 criteria were identified from the literature. In addition, a questionnaire was sent to the relevant construction material selection professionals to obtain the criteria considered in responsible materials sourcing in the building construction industry in the Global South. The group factors considered for responsible material sourcing using provenance as a datum in the study were environmental, technological, resource use and socio-economic. All of the variables deemed to influence responsible sourcing of construction materials were subjected to a principal component analysis (PCA). PCA found four components with eigenvalues greater than one, accounting for 34.2 per cent of environmental criteria, 12.10 per cent of resource consumption criteria, 8.4% of technological criteria, and 6.9% of socio-economic criteria. As a result, all of the variables were significant, confirming the conclusions of the literature data were consistent with the responsible sourcing of construction materials in Ghana as a country in the Global South; this corroborates the research carried out by Lee et al. (2020); Baglou et al. (2017); Akadiri et al. (2013); Akadiri and Olomolaiye (2012); Akadiri (2011) and thus confirms and validates the findings from theory are relevant to the Global South context.

Material quality due to source obtained the highest mean of 4.79, supporting Wilson's (2007) study. The gravity model enables one to determine where to obtain their needs based on the probability of attraction to the source. However, eutrophication as a factor had the lowest environmental consideration, a mean of 3.46. It is a critical requirement that necessitates additional research because it contributes significantly to the general degradation of water quality, increases algae, and may cause morphological changes in the environment. This study provides an excellent start when looking at responsible material sourcing in the construction industry to promote materials sustainability.

## REFERENCES

- Akadiri, P. O., (2011). Development of a multi-criteria approach for the selection of sustainable materials for building projects. PhD Thesis - the University of Wolverhampton, [online] pp.1-437. Available at: <[http://wlv.openrepository.com/wlv/bitstream/2436/129918/1/Akadiri\\_PhD\\_thesis.pdf](http://wlv.openrepository.com/wlv/bitstream/2436/129918/1/Akadiri_PhD_thesis.pdf)>.
- Akadiri, P. O., & Olomolaiye, P. O. (2012). Development of sustainable assessment criteria for building materials selection. *Engineering, Construction and Architectural Management*, 19(6), pp.666-687.
- Akadiri, P. O., Olomolaiye, P. O., & Chinyio, E. A. (2013). Multi-criteria evaluation model for the selection of sustainable materials for building projects. *Automation in Construction*, [online] 30, pp.113-125. Available at: <<http://dx.doi.org/10.1016/j.autcon.2012.10.004>>.

- Baglou, M., Ghoddousi, P., & Saeedi, M., (2017). Evaluation of Building Materials Based on Sustainable Development Indicators. *Journal of Sustainable Development*, 10(4), p.143.
- BRE Global, (2016). BES 6001. Framework Estandar for Responsible Sourcing. BRE Global, (2), p.368.
- Van den Brink, S., Kleijn, R., Tukker, A., & Huisman, J., 2019. Approaches to responsible sourcing in mineral supply chains. *Resources, Conservation and Recycling*, [online] 145(November 2018), pp.389–398. Available at: <<https://doi.org/10.1016/j.resconrec.2019.02.040>>.
- Chhipi-Shrestha, G. K., Hewage, K., & Sadiq, R., (2015). 'Socializing 'sustainability: a critical review of the current development status of the social life cycle impact assessment method. *Clean Technologies and Environmental Policy*, 17(3), pp.579–596.
- Farahzadi, L., Urbano Gutierrez, R., Riyahi Bakhtiari, A., Azemati, H., & Hosseini, S. B., (2016). Assessment of Alternative Building Materials in the Exterior Walls for Reduction of Operational Energy and CO2 Emissions. *International Journal of Engineering and Advanced Technology (IJEAT)*, (September), pp.0–7.
- Glass, J., (2011). Briefing: Responsible sourcing of construction products. In: *Proceedings of the Institution of Civil Engineers: Engineering Sustainability*. pp.167–170.
- Glass, J., Achour, N., Parry, T., & Nicholson, I., (2012). Engaging small firms in sustainable supply chains: Responsible sourcing practices in the U.K. construction industry. *International Journal of Agile Systems and Management*, 5(1), pp.29–58.
- Gonçalves de Lássio, J. G., & Naked Haddad, A., (2016). Life cycle assessment of building construction materials: case study for a housing complex TT - Evaluación de ciclo de vida de materiales de edificaciones: estudio de caso en complejo de viviendas. *Revista de la construcción*, [online] 15(2), pp.69–77. Available at: <[http://www.scielo.cl/scielo.php?script=sci\\_arttext&pid=S0718-915X2016000200007&lang=pt](http://www.scielo.cl/scielo.php?script=sci_arttext&pid=S0718-915X2016000200007&lang=pt)>.
- Hosseinjou, S. A., Mansour, S., & Shirazi, M. A., (2014). Social life cycle assessment for material selection: A case study of building materials. *International Journal of Life Cycle Assessment*, 19(3), pp.620–645.
- International Trade Organisation, (2020). Ghana - Country Commercial Guide on Infrastructure. [online] International Trade Administration. Available at: <<https://www.trade.gov/country-commercial-guides/ghana-construction-and-infrastructure>> [Accessed 26 Feb. 2021].
- JRC Technical Report by the European Commission, (2014). *Social life cycle assessment revisited*. Sustainability (Switzerland), Luxemburg.
- Kelava, A., (2016). A Review of Confirmatory Factor Analysis for Applied Research. 20(June), p.2016.
- Lee, D., Lee, D., Lee, M., Kim, M., & Kim, T., (2020). Analytic hierarchy process-based construction material selection for performance improvement of building construction: The case of a concrete system form. *Materials*, 13(7).
- Levin, H., (2016). *Building Ecology: An Architect's Perspective -- Plenary Lecture*. (November 2014).

- Mark N. K. Saunders, P. L., & A. T., (2019). *Research methods for Business Students*. Eighth Edn ed. [online] New York: Pearson Education Limited. Available at: <[www.pearson.com/uk](http://www.pearson.com/uk)>.
- Mesa, J., González-Quiroga, A., & Maury, H., (2020). Developing an indicator for material selection based on durability and environmental footprint: A Circular Economy perspective. *Resources, Conservation and Recycling*, [online] 160(January), p.104887. Available at: <<https://doi.org/10.1016/j.resconrec.2020.104887>> [Accessed 21 Mar. 2021].
- Pacheco-Torgal, F., & Jalali, S., (2011). Toxicity of building materials: A key issue in sustainable construction. *International Journal of Sustainable Engineering*, 4(3), pp.281–287.
- Paquette, J. R., (2006). *The Supply Chain Response to Environmental Pressures*. Massachusetts Institute of Technology.
- Pesämaa, O., Zwikael, O., Hair, J. F., & Huemann, M., (2021). Publishing quantitative papers with rigour and transparency. *International Journal of Project Management*, 39(March), pp.217–222.
- Ramchandani, P., Bastani, H., & Moon, K., (2020). Responsible Sourcing: The First Step Is the Hardest. *SSRN Electronic Journal*, (ILO), pp.1–37.
- Ruuska, A., & Häkkinen, T., (2014). Material efficiency of building construction. *Buildings*, 4(3), pp.266–294.
- Upstill-Goddard, J., Glass, J., Dainty, A. R. J., & Nicholson, I., (2015). Analysis of responsible sourcing performance in BES 6001 certificates. *Proceedings of the Institution of Civil Engineers: Engineering Sustainability*, 168(2), pp.71–81.
- Wilson, L., (2007). Understanding Prehistoric Lithic Raw Material Selection : Application of a Gravity Model. *Journal of Archaeological Method and Theory*, [online] 14(4), pp.388–411. Available at: <<https://www.jstor.org/stable/25702351> REFERENCES>.
- Xu, M., Chen, D., Yu, Y., Chen, Z., Zhang, Y., Liu, B., Fu, Y., & Zhu, B., (2020). Assessing resource consumption at the subnational level: A novel accounting method based on provincial selected material consumption. *Journal of Industrial Ecology*, pp.1–13.
- Young, J., & Osmani, M., (2013). Investigation into contractors 'responsible sourcing implementation practice. *Proceedings of the Institution of Civil Engineers: Engineering Sustainability*, 166(6), pp.320–329.





---

## REVIEW OF RISK MANAGEMENT STUDIES: TOWARDS A FRAME OF REFERENCE FOR LARGE PROJECTS

Rilwan Shuaib Abdulrahman<sup>1</sup>, Ahmed Doko Ibrahim<sup>2</sup>, Baba Adama Kolo<sup>3</sup> and Hassan Adaviriku Ahmadu<sup>4</sup>

<sup>1,2,3,4</sup>*Department of Quantity Surveying, Faculty of Environmental Design, Ahmadu Bello University, Zaria, Nigeria*

Construction is a high risk industry that operates a very complex and dynamic environment, which significantly contributes to the existence of high uncertainty and risk in construction projects. Journal articles on review of literature surrounding risk abounds in construction management studies. However, such considerations have assumed a silo approach to risk management, for instance, focus on processes, thereby neglecting the holistic perspective to risk management. The absence of this holistic perspective results in sub-optimality in knowledge within this domain. Therefore, this study aims to undergo a systematic literature review, with the purpose of bringing forth a holistic perspective of researches in this field. Findings shows that studies in this domain have largely focused on three main themes of risk management, namely: practices, maturity and processes, with particular emphasis on processes. While the overwhelming majority of these studies are replicative, they fail to advance the frontiers of risk management knowledge for large projects. Such advancement is recognised within risk systemicity. However, studies focused within risk systemicity have continued to follow the trend in generic risk management considerations i.e. the silo approach. Although, risk systemicity consideration is relatively new, the lack of research on interactions and interdependencies within and between sub-systems opens newer directions for risk management studies, particularly large projects. For instance, bringing out the components of a risk management system and studying the interactions within each component and those across them. Hence, the outcome of this paper, amongst others, contributed immensely as part of an on-going PhD research on modelling the dynamic interaction of risk in large construction projects.

Keywords: large projects, risk interdependences, risk management, risk systemicity

### INTRODUCTION

Construction is a high risk industry that operates a very complex and dynamic environment, which significantly contributes to the existence of high uncertainty and risk in construction projects (Siraj, & Fayek, 2019). Because of these

---

<sup>1</sup> ridwanshuayb1@gmail.com; Tel. +2347039704488

<sup>2</sup> adibrahim2@yahoo.com

<sup>3</sup> babaadamakolo@gmail.com

<sup>4</sup> ahmaduhassan@rocketmail.com

complexities, the success of construction projects is usually highly dependent on the quality of preparation and planning prior to execution (Firmenich, 2017). However, despite the preparation and planning prior to execution, many complex projects have been adjudged unsuccessful (Williams, 2017). This largely results from poor understanding of the risk management, which is a major success factor in all types of projects especially in large projects, as it can help project managers to anticipate delays that cause projects not to be delivered on time among other benefits. Although, risks are not fully predictable but with effective risk management practice, potential damage can be mitigated.

Researches in this domain have largely attributed construction project failure to a number of problems such as: lack of systematic & formal approach to risk management, ineffective & inapplicable risk management models, lack of capacity to manage risk, among others (Nawaz, Waqar, Adnan, Shah, & Sajid, 2019; Abdulrahman, Ibrahim & Chindo, 2019; Khallaf, Naderpajouh, & Hastak, 2018; Salawu & Abdullah, 2015; Serpell, Ferrada, Rubio, & Arauzo, 2015). As a result, studies have proffered many replicative and fragmented solutions to these problems (Chileshe, & Kikwasi, 2014; Yirenkyi-fianko, et al., 2015; Gajewska & Ropel, 2011) through various forms of assessment, development of models and approaches that will enhance the effectiveness of risk management.

Literature on construction risk management is abound, therefore, it becomes very important to review and understand the development of studies in this domain, to enable the uncovering of new areas and closing of saturated ones. Attempts have been made to review risk management studies (Siraj & Fayek, 2019; Bahamid & Doh, 2017; Renault & Agumba, 2016; Tesfaye, Berhan & Kitaw, 2016), however, those attempts have yielded similar silo approach of focusing on specific aspect of risk management, rather than a holistic approach. The absence of this holistic perspective results in sub-optimality in knowledge within this domain. Therefore, this study aims to undergo a systematic literature review, with the purpose of bringing forth a holistic perspective of researches in this field.

This study is broken down into sections of which the first has just been discussed as the introduction. The rest of the paper is articulated as follows; in the second section, an overview of the research themes is provided. Also a summary of the previous literature reviews on risk management is provided. The third section is the methodology which talks about how the research was conducted. The fourth section is the reporting of result from the extensive reviews and lastly, conclusions and recommendations for future works.

## **LITERATURE REVIEW**

### **Risk management process**

Risk management is the process of conducting risk management planning, identification, analysis, response planning, response implementation and monitoring risk on a project (PMI, 2017). The whole essence of risk management is to decrease the probability and / or impact of negative risks and increase the probability and / or impact of positive risks, to increase the chances of project success. Risk Management (RM) is greatly influenced by the uniqueness of the

construction industry in a specific country; it is influenced by different project typologies as well as organisations' risk management maturity.

Several researches have been conducted focusing on risk assessment and risk response stages of the risk management process. For instance; Ojo (2010) assessed the construction site related risk factors. His argument is that studies have concentrated on other aspects of project risks and have not looked at site risks; on the one hand this is highly questionable because, studies dealing with project risks would have included site risks as part of the overall project risks. On the other hand, he assumed that risk factors and risk are the same. According to PMI (2017) only risk can be assessed using the risk management process and not the risk factors that cause risks. Several studies are guilty of using risk factors and risks interchangeably, when in fact they are different.

Other studies (Ibronke, Famakin, Akingunola, 2011; Abd El-Karim, Naway & Abdel-Alim, 2017; Sanda, Anigbogu, Rugu & Babas, 2020) have also assessed either risk or risk factors using almost identical methods that include the use of questionnaires surveys and qualitative risk assessment techniques. According to Dziadosz & Rejment (2015) the most common risk assessment method is the product of the likelihood of occurrence and the magnitude of impact which results to risk criticality. Almost all studies on risk assessment either used this technique alone or in collaboration with other techniques. Bahamid & Doh (2018) identified brainstorming, expert judgment; cause and effect diagram; checklists; Delphi; Event Tree Analysis (ETA); Risk Breakdown Matrix (RBM); risk data quality assessment as the main qualitative risk analysis techniques while decision tree analysis; expected monetary value; Fault Tree Analysis (FTA); fuzzy logic; probability distributions; sensitivity analysis/tornado diagram as the main quantitative analysis techniques.

Generally, studies on risk management are largely replicative; in that the same or very similar tools and techniques are used for instance; questionnaire survey in collecting data, most studies used qualitative risk assessment approach, overwhelming majority of studies used risk factors and risks interchangeably and there doesn't seem to be a standard form of classifying risks. Bahamid & Doh (2018) reported in their study that various approaches have been used to classify risks in literature. Cakmak & Tezel (2019) reported the similar finding, a clear indication of the need to have a standard approach for risk classification.

### **Risk management practices**

Owing to the importance of risk management in project management, its efficiency is expected to significantly influence project performance but because of reasons such as; lack of systematic & formal approach to risk management, its influence has been questionable, leading to investigation on the impact of risk management on project performance. Strutt (1993) in his study found that risk management strategies lead to project success. However, reports from literature shows that construction practitioners rarely utilize the formal risk management process in their projects and that "direct judgment, personal skills and comparing analysis of similar projects with similar conditions" are the most frequently used risk analysis techniques (Yirenkyi-fianko, et al., 2015; Jin, Zhang, Liu, Feng, & Zuo, 2017). In Nigeria, studies have reported that not only is the adoption of risk management process low, they also lack the understanding of risk management process (Ojo,

2010; Augustine et al., 2013). Consequently, these practices by construction organisations have been reported to be ineffective particularly amongst the small and medium size organisations as they have been underperforming due to their inability to manage risk (Algahtany, Alhammadi, & Kashiwagi, 2016; Oduoza, Odimabo, & Tamparopoulos, 2017).

Furthermore, Oyewobi, Ibrahim & Ganiyu (2012) reported that identified risk are not rigorously examined and even when they have been assessed and remedial measures agreed upon, they are not generally communicated effectively. Thus, project participants do not have a shared understanding of the risks that threaten a project and, consequently, they are unable to implement effective early warning measures and mitigating strategies to adequately deal with problems resulting from decisions that were taken elsewhere in the chain. Hence, the industry continues to suffer poor performance with many projects failing to meet time and cost targets.

This facet of risk management studies has a direct relationship with organisations RMM level, since the maturity level of organisations is assessed based on certain parameters or attributes associated with organisations that have made some efforts towards implementing risk management. Majority of studies on risk management practices have reported the lack of implementation of the risk management process as the ultimate problem to studies in this area.

### **Risk management maturity**

The risk management maturity (RMM) reflects the sophistication of an organization's understanding of its risk portfolio and how to manage those risks (Zou, Chen & Chan, 2010). According to Mafakheri, Breton & Chauha (2012), if an organisation is highly matured in the management of identified risk events on projects, the consequence of the risk events on project performance objectives will be reduced. Several researchers have stressed the importance of assessing the RMM of construction organisations, as it is the commencing point in comprehending their risk management capabilities (Zou et al., 2010; Mu, et al., 2013; Salawu and Abdullah, 2015). Loosemore, Raftery, Reilly & Higgon (2006) indicated that many organizations operate at different levels of maturity for different types of risks. For example, an organization's risk management culture may be as low as level 1 but achieved level 3 in risk management processes. This means that while organizations may have developed sophisticated risk management systems, they have not fully imbedded it within their organizational behaviour and practices. In addition, Hopkinson (2011) indicated that assessing RMM can help to identify the strengths and weaknesses of the organization and can also identify areas needing improvement.

Studies across different regions of the world have demonstrated different maturity levels for different project types. However, studies conducted in the developed countries have reported higher maturity levels relative to those in the developing countries (Abdulrahman et al., 2019; Salawu & Abdullah, 2015; Mu et al., 2013; Zou et al., 2010). The point here is that organisations must understand their RMM levels in order to stand the chance delivering projects successfully. Although, knowing and understanding their maturity may not be enough, as they may be lacking in one aspect or the other. Therefore, there is need for organisations to continuously

improve on the aspects that requires improvement through development of strategies that will promote progression.

### **Previous state of the art reviews in construction risk management**

Risk management is one of the most researched areas in the construction industry, however, only few studies have attempted to review existing literature to show development trends (Siraj & Fayek, 2019). Studies by Taroun (2013) reviewed articles on risk modelling and assessment over a twenty-nine (29) years (1983-2012). Studies (Bahamid & Doh, 2017; Renault & Agumba, 2016) have reviewed and brought forth the frequently used risk management techniques in construction industry. Islam, Nepal, Skitmore & Attarzadeh (2017) reviewed research trends and application areas of fuzzy and hybrid methods to the risk assessment of construction projects. Content analysis of eighty-two (82) research articles published between 2005-2017 was used in the study. Yu, Chan, Chen & Darko (2018) conducted a systematic review of the critical risk factors of transnational public-private partnership projects. In their study, a total of thirty-seven (37) articles published between 1991-2015 were used to study the trends as well as identifying the critical risk factors of transnational public private partnership (TPPP) projects. Similarly, Tesfaye, Kitaw & Berhan (2016) undertook systematic review and meta-analysis on risk assessment of construction project literature over the past twenty (20) years. They reported statistical analysis and fuzzy expert system as the dominant risk assessment tools used. Several attempts have been made to capture the development of studies in risk management, the most recent being that of Siraj & Fayek (2019) where risk identification tools and techniques, risk classification methods and the most common risks in construction projects were reported. In their study, a systematic review and content analysis of one hundred and thirty (130) research articles was selected over the previous thirty (30) years. Their findings revealed that majority of the articles identified risks mainly for infrastructure projects and either categorised the risks based on their nature or simply listed them out. Although, the above reported studies have reviewed almost all aspects of risk management, they have all being in silo approach, rather than a holistic approach which provides better insight to the risk management as a system. Looking at the risk management as a system, it is made up of three essential components of causation, risks and consequences. This can be Fitted into the input, process and output structure of a system. In this case, the causation (risk factors or sources of risk) is the input, the risks (risk management process) being the process and lastly, the consequences (effects) being the output. Of course equally important are the existing reviews which have adopted the silo approach and can be viewed as sub-systems or components within the larger system (risk management system). However, it is also very important to have a holistic view of the entire system.

## **RESEARCH METHODOLOGY**

A three (3) stage process adopted by Siraj & Fayek (2019) was modified into a two (2) stage process for this study. The modifications were on the initial stage of the process which involves journal selection. Figure 1 below shows details of the review process.

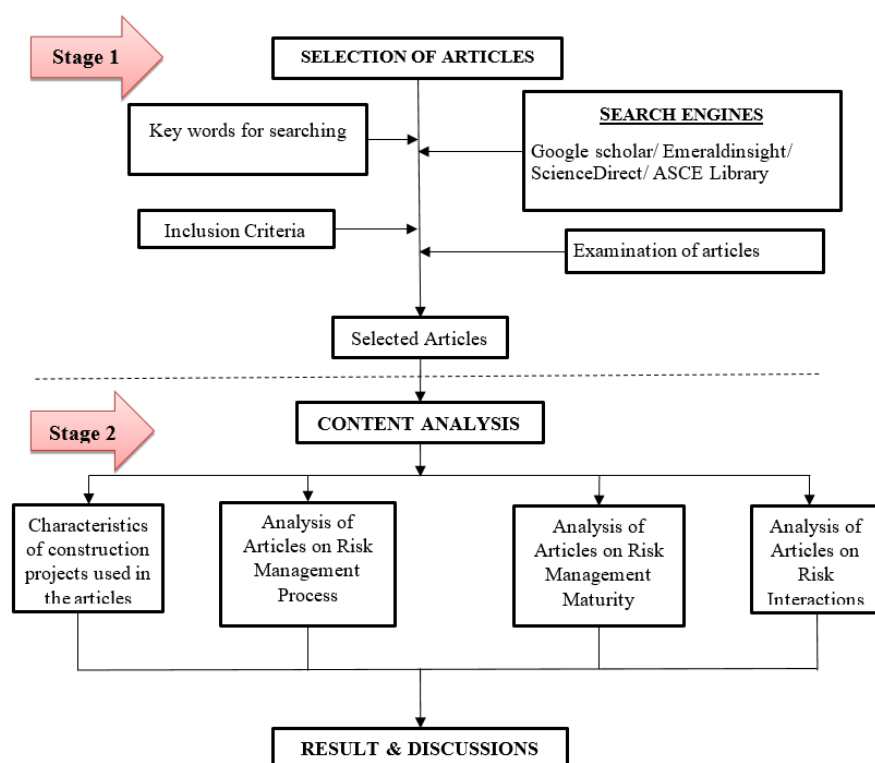

Figure 1: Research Methodology for Articles selection

### Article selection

At the first stage, articles were first identified using the keywords to search from these online databases; Science Direct, Emeraldinsight, Google Scholar and ASCE library. The keywords were selected from review articles (Nabawy & Khodeir, 2020; Siraj & Fayek, 2019; Tesfaye, Berhan & Kitaw, 2016) on risk related topics, based on the common keywords used by researchers. For the purpose of this study the search words include; "Construction risk management", "risk identification and assessment", "Risk modelling in construction", "risk interactions in construction projects" etc. A number of different variations of the search words were used to collate articles within this domain over a ten (10) year period (2010-2020). Consequently, a total of 135 articles were found and more importantly, reduced to 94 articles as a result of systematic refinement to collate articles that are more relevant to the study. Furthermore, these articles were then reviewed to capture details of existing information regarding risk management as well as project information used in the selected articles. The following were the inclusion criteria in the selection of articles:

1. Only accessible articles within the following databases; Science Direct, Emeraldinsight, Google Scholar and ASCE library were used
2. Articles selected must focus on risk management in construction industry
3. Articles must have been published between the year 2010 and 2020
4. Articles must be within risk management process, risk management practices, risk management maturity and/or risk interactions

### **Content analysis**

Content analysis can be used to determine the categories of a group of data, by counting the number of times an activity occurs (Fellow & Liu, 2015). It has also been defined as a powerful technique for gathering information and evaluating the trends and patterns in a document or documents (Siraj & Fayek, 2019). The first step in undertaking a content analysis is to identify the materials to be analysed, then determine the form of content analysis to be used. The type of content analysis could be qualitative, quantitative or structural depending on the nature of the research issues to be addressed.

However, for qualitative content analysis, the focus is on determining the meaning of data, while for quantitative content analysis the focus is on producing numerical data ratings, frequencies, rankings and so on and lastly, structural content analysis is focused on examining the relationships between groups of data.

This research will use qualitative content analysis in understanding the nature of researches in the field of construction risk management. Hence, the last stage of this methodology requires detailed content analysis to synthesize information regarding characteristics of the projects and the geographical regions used in the articles, analysis of articles that focused on risk management process, risk management maturity and risk interactions.

## **RESULTS AND DISCUSSIONS**

### **Profile of the projects in the selected articles**

The construction projects considered in the articles used for this review were profiled on the basis of their geographical region and project types. The selected articles encompassed the entire risk management process; risk management practices, risk management maturity, risk management process, and risk interactions in various project types. The projects were widely grouped into three (3) categories based on the nature of construction works and they are listed as follows; building construction works (residential, office, commercial, etc.), Infrastructural works (Highway, Tunnel, Railway and pile works) and large projects (mega projects and complex projects).

Having reviewed 94 risk management articles over a ten (10) year period, result shows that the most common project type used in literature is building construction works with 66%, Infrastructural works 15% and large projects 19% as shown in Table 1 below.

Building construction works has the highest percentage (65.96%) in terms of the number of published articles in that category, probably because it has a wider range of projects subsumed in that category and also the fact that there is more number of projects under construction in this category particularly in the African region. Another reason could be the willingness of key stakeholders to participate in researches focusing on this type of projects. Infrastructural works and large projects have 14.89% and 19.15% in terms of the number of published articles in these categories respectively. Although, infrastructural development plays a vital role in the economic and social development of both developed and developing countries (Siraj & Fayek, 2019), reasons such as; lack of participation of key

stakeholders in researches focusing on infrastructural projects could deter researchers from conducting studies in this facet. Also, these projects are complex and as a result the uncertainties are likely to be more interdependent, interconnected, subject to change or there will be socio-political risks whose effects are unknown (Williams, 2017).

**Table 1: Categories of projects in published articles**

FEATURE	CATEGORY	NUMBER OF ARTICLES	PERCENTAGE OF ARTICLES
Project Type	Building Construction Projects	62	65.96
	Infrastructural Projects	14	14.89
	Large Projects	18	19.15
	TOTAL	94	100.00
Geographical Region of Projects	Africa	26	27.66
	America	6	6.38
	Asia	33	35.11
	Europe	29	30.85
	TOTAL	94	100.00

Furthermore, risk management is a wide area of research with varieties of research categories, this study has therefore, categorised studies in this domain based on the nature of researches published. The categories are as follows; review papers, risk management practices, risk management maturity, risk management process and risk interactions. It was observed that review articles focused on individual component within the risk management process, for instance; review article (Siraj and Fayek 2019) on risk identification tools and techniques, others are on risk assessment and response techniques (Islam, Nepal, Skitmore & Attarzadeh, 2017; Renault & Agumba, 2016). Table 2 shows categories and number of articles within risk management studies over the period considered.

**Table 2: Categories of published articles on risk management**

FEATURE	CATEGORY	NUMBER OF ARTICLES	PERCENTAGE OF ARTICLES
RISK MANAGEMENT	Review Papers	11	11.70
	Risk management practices	5	5.32
	Risk management maturity	8	8.51
	Risk management process	46	48.94
	Risk interactions	24	25.53
	TOTAL	94	100.00



Result shows that 11.7% of the total articles reviewed are on review papers, 5.32%, 8.51%, 48.94% and 25.53% are on risk management practices, risk management maturity, risk management process and risk interactions respectively.

11.70% for the review papers denotes the efforts that has been made by researchers (Siraj and Fayek 2019; Islam, et al., 2017; Renault & Agumba, 2016; Taroun, 2013) towards reviewing studies to report what has been done and also to capture future directions. Articles on review of literature surrounding risk abounds in construction management studies. However, such considerations have assumed a silo approach to risk management, for instance, focus on processes, thereby neglecting the holistic perspective to risk management.

Similarly, articles focusing on risk management practices and maturity have 5.32% and 8.51% respectively of the total number of articles reviewed. This could be an indication that these areas are saturated, due to the relatively low amount of publications in the area and also being that the most recent publication on risk management practices was in 2017 and that of risk management maturity (RMM) was in 2019. Cakmak & Tezel (2019) also opined that risk management literature may have reached saturation. However, there are renewed efforts on RMM towards developing strategies on how to move from a lower maturity level to a higher level. This is very important because, reports show that organisations in developed countries apply systematic risk management and have superior maturity levels relative to organisations in the developing countries. Furthermore, the risk management practices of organizations in developing countries have been found generally to be inadequate due to it not being structured.

Most importantly, majority of the articles reviewed focused on risk management process largely because it encompasses more subdivisions (risk identification, assessment, response, monitoring and controlling). Although, even within the risk management process, studies have paid more attention to the risk assessment stage. Perhaps researchers believe it is the most important stage within the entire process. This is highly questionable, in fact the plan risk management and risk identification that have seemingly been relegated are the two (2) most important stages of risk management, because they are inputs in all other stages of the process. This means other stages cannot be carried out without these two stages. It is important to note that the overwhelming majority of articles in this facet are replicative and therefore, will not advance the frontiers of knowledge in this domain.

Lastly, articles on risk interactions could form part of the risk assessment within the risk management process category, but it was extracted to enable a more indebt review and discussion. For this category, there were 24 articles amounting to 25.53% of the total articles reviewed for this research. About 70.83% of the articles in this category were published between 2017 and 2021, except for review papers with 81.82%, other categories were 16.67%, 25% and 52.17%. This is a clear indication that researchers are beginning to focus more on this area. This could be the resulting effect of previous approaches 'inability to capture complex, multiple feedback and highly dynamic interactions among several risks (Korytarova & Hromadka, 2021; Guan, et al., 2020; Boateng, 2017).

## CONCLUSIONS AND RECOMMENDATIONS

Journal articles on review of literature surrounding risk abounds in construction management studies. However, such considerations have assumed a silo approach to risk management, for instance, focus on processes, thereby neglecting the holistic perspective to risk management. This research has therefore, brought forth a holistic perspective to risk management through a systematic review of articles in this domain over the last decade (2010-2020).

The study found that there are very few articles focusing on risk management practice, probably because the area is saturated or because the problems of risk management has more to do with the development of systematic methodologies rather than the practices.

Similarly, very few studies have focused on RMM over the last ten (10) years, although, renewed efforts on RMM are geared towards developing strategies on how to move from a lower maturity level to a higher level.

Findings shows that risk management studies have largely focused on risk management process (risk identification, assessment, response, monitoring and controlling) with particular emphasis on risk assessment, other categories such as risks management practices, maturity and interactions have been paid little attention. This finding is in tandem with that of Cakmak & Tezel (2020) whose research was on the present knowledge and future directions of researches in risk management. Also it was observed that, there is no clear distinction between risk factors and risks in literature, as several studies (Abdulrahman, et al., 2019; Maina, & Mbabazize, 2016; Boateng & Chen, 2012) have used both terminologies interchangeably, which in fact are different. Studies by Siraj & Fayek (2019) also reported similar findings on risk management literature lacking a standardized risk classification approach. Consequently, studies in this facet are overwhelmingly replicative and so have failed to advance the frontiers of risk management knowledge.

Lastly, studies on risk interactions have also begun the trend of replicating studies by focusing solely on risk interactions at the assessment and response stages of the risk management process. The point made does not invalidate existing studies; it only means that there is need to look at other components within the risk management system.

This research will benefit researchers in showing research trends in this domain as well as future directions in each category within risk management studies, as highlighted below:

With regards to articles on review and risk management practices, there are no clear future directions, as they seemed saturated.

For articles on RMM, future research should focus on developing strategies on how to move and sustain a higher maturity level across different categories of organisations

Future research on risk management process should focus on;

- Establishing a clear difference between risk factors and risks
- Determining a standard methodology for risk classification.
- Using artificial intelligence techniques in risk management

Finally, studies should research into risk interactions by focusing on other stages such as; the interactions between the causes of risks and risks and the interactions within the entire risk management system. That is the interactions between risk factors, risks, risk assessment, risk response, risk monitoring and controlling should be researched.

## REFERENCES

- Abd El-Karim, M. S. B. A., Naway, O. A. M., & Abdel-Alim, A. M. (2017). Identification and assessment of risk factors affecting construction projects. *Housing and building national research centre*, 13, 202-216.
- Abdulrahman, R. S., Ibrahim, A. D., & Chindo, P. G. (2019). Assessment of risk management maturity of construction organisations in joint venture projects. *Journal of Engineering, Project, and Production Management*, 9(1), 20–28. <https://doi.org/10.2478/jepm-2019-0004>
- Adeleke, A. Q., Bahaudin, A. Y., Kamaruddeen, A. M., Bamgbade, J. A., Salimon, M. G., Waris, M., Khan, A., & Sorooshian, S. (2018). The Influence of Organizational External Factors on Construction Risk Management among Nigerian Construction Companies. *Safety and Health at Work*, 9(1), 115–124. <https://doi.org/10.1016/j.shaw.2017.05.004>
- Afzal, F., Yunfei, S., Nazir, M., & Bhatti, S. M. (2021). A review of artificial intelligence based risk assessment methods for capturing complexity-risk interdependencies: Cost overrun in construction projects. *International Journal of Managing Projects in Business*, 14(2), 300–328. <https://doi.org/10.1108/IJMPB-02-2019-0047>
- Algahtany, M., Alhammadi, Y., & Kashiwagi, D. (2016). Introducing a New Risk Management Model to the Saudi Arabian Construction Industry. *Procedia Engineering*, 145(480), 940–947. <https://doi.org/10.1016/j.proeng.2016.04.122>
- Armstrong, H. L., & McCulloh, I. (2010). Organizational risk using network analysis. *Proceedings of the South African Information Security Multi-Conference, SAISMC 2010*, 132–141.
- Augustine, A. N., Ajayi, J. R., Ade, B. A., & Edwin, A. A. (2013). An investigation of the perceptions of contractors and consultants. *International Journal of Pure and Applied Sciences and Technology*, 16, 20–31.
- Baghdadi, A., & Kishk, M. (2015). Saudi Arabian aviation construction projects: Identification of risks and their consequences. *Procedia Engineering*, 123, 32–40. <https://doi.org/10.1016/j.proeng.2015.10.054>
- Bahamid, R. A., & Doh, S. I. (2017). A review of risk management process in construction projects of developing countries. *IOP Conference Series: Materials Science and Engineering*, 271(1). <https://doi.org/10.1088/1757-899X/271/1/012042>
- Basaif, A. A., Alashwal, A. M., Mohd-Rahim, F. A., & Abd Karim, S. B. (2018). A review on the application of artificial intelligence for risk analysis in construction projects. *Proceedings of the ASEAN Post Graduate Conference (APGC) 2018*, University of Malaya, Kuala Lumpur, 15 November 2018, November, 42–51.

- Basaif, A. A., Alashwal, A. M., Mohd-Rahim, F. A., Karim, S. B., & Bari, A. K. S. (2020). Technology awareness of artificial intelligence (Ai) application for risk analysis in construction projects. *Malaysian Construction Research Journal*, 9(1 Special issue), 182–195.
- Boateng, P., Ahiaga-dagbui, D. D., Chen, Z., & Ogunlana, S. O. (2015). Modelling Economic Risks in Megaproject Construction: A Systemic Approach. In: *Procs 31st Annual ARCOM Conference*, Raiden A and Aboagye-Nimo E (Eds), Association of Researchers in Construction Management 7-9th Sept, 2015.
- Boateng, P., & Chen, Z. (2012). A system dynamics approach to risks description in megaprojects development. *Organization, Technology and Management in Construction – an international Journal*, 4(3), 593–603. <https://doi.org/10.5592/otmcj.2012.3.4>
- Cakmak, P. I., & Tezel, E. (2019). A guide for risk management in construction projects: present knowledge and future directions. *Intechopen*, 1–14. <http://dx.doi.org/10.5772/intechopen.84361>
- Chatterjee, K., Zavadskas, E. K., Tamošaitiene, J., Adhikary, K., & Kar, S. (2018). A hybrid MCDM technique for risk management in construction projects. *Symmetry*, 10(2). <https://doi.org/10.3390/sym10020046>
- Chileshe, N., Kikwasi, G. J., Chileshe, N., & Kikwasi, G. J. (2014). Critical success factors for implementation of risk assessment and management practices within the Tanzanian construction industry. *Engineering, Construction and Architectural Management*, 21(3), 291–319. <https://doi.org/10.1108/ECAM-01-2013-0001>
- Chou, J. S., & Lin, J. W. (2020). Risk-informed prediction of dredging project duration using stochastic machine learning. *Water (Switzerland)*, 12(6). <https://doi.org/10.3390/w12061643>
- Coetzee, G. P., & Lubbe, D. (2013). The risk maturity of South African private and public sector organisations University of the Free State. *Southern African Journal of Accountability and Auditing Research*, 14, 45–56.
- Dandage, R. V, Mantha, S. S., Rane, S. B., & Bhoola, V. (2018). Analysis of interactions among barriers in project risk management. *Journal of Industrial Engineering International*, 14(1), 153–169. <https://doi.org/10.1007/s40092-017-0215-9>
- Deng, M. (2018). Challenges and Thoughts on Risk Management and Control for the Group Construction of a Super-Long Tunnel by TBM. *Engineering*, 4(1), 112–122. <https://doi.org/10.1016/j.eng.2017.07.001>
- Dziadosz, A. (2015). Risk analysis in construction project - chosen methods . *Procedia Engineering*, 122(Orsdce), 258–265. <https://doi.org/10.1016/j.proeng.2015.10.034>
- Erol, H., Dikmen, I., Atasoy, G., & Birgonul, M. T. (2020). Exploring the Relationship between Complexity and Risk in Megaconstruction Projects. *Journal of Construction Engineering and Management*, 146(12), 04020138. [https://doi.org/10.1061/\(asce\)co.1943-7862.0001946](https://doi.org/10.1061/(asce)co.1943-7862.0001946)
- Fang, C., Marle, F., Zio, E., & Bocquet, J. (2012). Network theory-based analysis of risk interactions in large engineering projects. *Reliability Engineering and System Safety*, 106, 1–10. <https://doi.org/10.1016/j.ress.2012.04.005>
- Fellows, R & Liu, A. (2015). *Research methods for construction*. 4th edition. John wiley & sons limited.
- Firmenich, J. (2017). Customisable framework for project risk management. *Construction Innovation*, 17(1), 68–89. <https://doi.org/10.1108/CI-04-2015-0022>

- Gajewska, E., & Ropel, M. (2011). Risk Management Practices in a Construction Project – a case study. In Master of Science Thesis. Chalmers University of Technology.
- Grabovy, P. G., & Orlov, A. K. (2016). The Overall Risk Assessment and Management : Implementation of Foreign Investment Construction Megaprojects by Russian Development Companies. *Procedia Engineering*, 153(905), 195–202. <https://doi.org/10.1016/j.proeng.2016.08.102>
- Guan, L., Abbasi, A., & Ryan, M. J. (2020). Analyzing green building project risk interdependencies using Interpretive Structural Modeling. *Journal of Cleaner Production*, 256, 120372. <https://doi.org/10.1016/j.jclepro.2020.120372>
- Guide, P., & Edition, F. (n.d.). *A Guide to the Project Management Body of Knowledge*.
- Gupta, V. K., & Thakkar, J. (2018). A quantitative risk assessment methodology for construction project. *Sādhanā*, 43(7),1–16. <https://doi.org/10.1007/s12046-018-0846-6>
- Hopkinson, M. M. (2011). *The Project Risk Maturity Model: Measuring and Improving Risk Management Capability*, England, Gower Publishing Ltd.
- Hosny, H. E., Ibrahim, A. H., & Fraig, R. F. (2018). Risk management framework for Continuous Flight Auger piles construction in Egypt. *Alexandria Engineering Journal*, 57(4), 2667–2677. <https://doi.org/10.1016/j.aej.2017.10.003>
- Ibironke, O. T., Famakin, I. O., & Akingunola, O. T. (2011). Evaluating Risk Factors for Build , Operate and Transfer Procurement in the evaluating risk factors for build , operate & transfer. *Built Environment Journal*, 8(1), 37–44.
- Irimia-diéguez, A. I., Sanchez-cazorla, A., & Alfalla-luque, R. (2014). Risk Management in Megaprojects. *Procedia - Social and Behavioral Sciences*, 119, 407–416. <https://doi.org/10.1016/j.sbspro.2014.03.046>
- Islam, M. S., Nepal, M. P., Skitmore, M., & Attarzadeh, M. (2017). Current research trends and application areas of fuzzy and hybrid methods to the risk assessment of construction projects. *Advanced Engineering Informatics*, 33, 112–131. <https://doi.org/10.1016/j.aei.2017.06.001>
- Issa, U. H., Mosaad, S. A., & Hassan, M. S. (2019). A model for evaluating the risk effects on construction project activities. *Journal of Civil Engineering and Management*, 25(7), 687–699.
- Jin, X., Zhang, G., Liu, J., Feng, Y., & Zuo, J. (2017). Major Participants in the Construction Industry and Their Approaches to Risks : a Theoretical Framework. *Procedia Engineering*, 182, 314–320. <https://doi.org/10.1016/j.proeng.2017.03.100>
- Junior, R. R., & Carvalho, M. M. De. (2013). Understanding the Impact of Project Risk Management on Project Performance : an Empirical Study. *Journal of Technology Management & Innovation*, 8(Special issue ALTEC), 64–78.
- Keshk, A. M., Maarouf, I., & Annany, Y. (2018). Special studies in management of construction project risks , risk concept , plan building , risk quantitative and qualitative analysis , risk response strategies. *Alexandria Engineering Journal*, 57(4), 3179–3187. <https://doi.org/10.1016/j.aej.2017.12.003>
- Khallaf, R., Naderpajouh, N., & Hastak, M. (2018). A systematic approach to develop risk registry frameworks for complex projects. *Built Environment Project and Asset Management*, 8(4), 334–347. <https://doi.org/10.1108/BEPAM-08-2017-0051>
- Khattak, A. A. J., Akhtar, R., Abas, M., Khalid, Q. S., Noor, S., Babar, A., & Azim, S. (2019). Risk management in construction projects: Perspective of contractors and owners. *WALIA Journal*, 35(1), 77–89.

- Kimiagari, S., & Keivanpour, S. (2019). An interactive risk visualisation tool for large-scale and complex engineering and construction projects under uncertainty and interdependence. *International Journal of Production Research*, 57(21), 6827–6855. <https://doi.org/10.1080/00207543.2018.1503426>
- Korytárová, J., & Hromádka, V. (2021). Risk assessment of large-scale infrastructure projects—assumptions and context. *Applied Sciences (Switzerland)*, 11(1), 1–12. <https://doi.org/10.3390/app11010109>
- Kutsch, E., & Hall, M. (2010). Deliberate ignorance in project risk management. *International Journal of Project Management*, 28, 245–247. <https://doi.org/10.1016/j.ijproman.2009.05.003>
- Kululanga, G., & Kuotcha, W. (2010). Measuring project risk management process for construction contractors with statement indicators linked to numerical scores. *Engineering, Construction and Architectural Management*, 17(4), 336–351. <https://doi.org/10.1108/09699981011056556>
- Loosemore, M., Raftery, J., Reilly, C. & Higgon, D. (2006). *Risk Management in Projects*. 2nd Ed. Oxon, UK: Taylor and Francis.
- Mafaker, F., Breton, M., & Chauhan, S. (2012). Project-to-organisation matching: an integrated risk assessment approach. *International journal of information technology project management*. 3 (3), 45-59.
- Maina, N. P., & Mbabazize, M. (2016). Evaluation of factors affecting effectiveness of risk management in public housing construction projects in Rwanda. A case of Batsinda housing project. *European Journal of Business and Social Sciences*, 5(1), 85–101.
- Marle, F. (2015). A structured process to managing complex interactions between project risks. *International Journal of Project Organisation and Management*, 6((1-2)), 4–32. 10.1504/IJPOM.2014.059742 . hal-01206326
- Maseko, C. M. (2017). Identification of risk factors affecting construction of projects: The case of emerging economy. *Risk Governance and Control: Financial Markets & Institutions*, 7(4), 246–259. <https://doi.org/10.22495/rgc7i4c2art7>
- Motaleb, O. H., & Kishk, M. (2014). Assessing risk response maturity: A framework for construction projects success in the United Arab Emirates. *International Journal of Managing Projects in Business*, 7(2), 247–262. <https://doi.org/https://doi.org/10.1108/IJMPB-03-2013-0013>
- Mu, S., Cheng, H., Chohr, M., & Peng, W. (2013). ScienceDirect Assessing risk management capability of contractors in subway projects in mainland China. *JPMA*. <https://doi.org/10.1016/j.ijproman.2013.08.007>
- Nabawy, M. & Khodeir, L. M. (2020). A systematic review of quantitative risk analysis in construction of mega projects. *Ain shams engineering journal*, <https://doi.org/10.1016/j.asej.2020.02.006>
- Nawaz, A., Waqar, A., Adnan, S., Shah, R., & Sajid, M. (2019). An Innovative Framework for Risk Management in Construction Projects in Developing Countries: *Risks*, 7(1). <https://doi.org/10.3390/risks7010024>
- Odimabo, O., & Oduoza, C. F. (2018). Guidelines to aid project managers in Conceptualising and implementing risk management building projects. *Procedia Manufacturing*, 17, 515–522. <https://doi.org/10.1016/j.promfg.2018.10.091>
- Oduoza, C. F., Odimabo, O., & Tamparopoulos, A. (2017). Framework for Risk Management Software System for SMEs in the Engineering Construction Sector. *Procedia Manufacturing*, 11(June), 1231–1238. <https://doi.org/10.1016/j.promfg.2017.07.249>

- Ojo, G. K. (2010). An assessment of the construction site-related factors. *The Professional Builder*, 1(1), 10–17.
- Okoli, C., & Schabram, K. (2012). A Guide to Conducting a Systematic Literature Review of Information Systems Research. *SSRN Electronic Journal*, December, 1–3. <https://doi.org/10.2139/ssrn.1954824>
- Ongkowijoyo, C. S., & Doloj, H. (2018). ScienceDirect ScienceDirect ScienceDirect Understanding of Impact and Propagation of Risk based on Social Understanding of Impact and Propagation of Risk based on Social Network Analysis Network Analysis. *Procedia Engineering*, 212, 1123–1130. <https://doi.org/10.1016/j.proeng.2018.01.145>
- Osman, M., Issa, U. H., & Eraqi, A. M. Z. (2020). Identifying the Risk Impact on Cost and Time of the Egyptian Non-Residential Buildings Projects. January. <https://doi.org/10.32628/IJSRSET196659>
- Oyewobi, L.O., Ibrahim, A. D. & Ganiyu, B. O. (2012) Evaluating the Impact of Risk on Contractor's Tender Figure in Public Buildings Projects in Northern Nigeria. *Journal of Engineering, Project, and Production Management*. 2, 2-13.
- Park, J., Park, B., Cha, Y., & Hyun, C. (2016). Risk Factors Assessment considering Change Degree for Mega-Projects. *Procedia - Social and Behavioral Sciences*, 218, 50–55. <https://doi.org/10.1016/j.sbspro.2016.04.009>
- Pereira, L., Ferreira, S., & Santos, J. (2020). The main causes of risk in residential real estate projects. *Journal of General Management*, 45(3), 152–162. <https://doi.org/10.1177/0306307019890095>
- Project Management Institute (2017). A guide to the project management body of knowledge. 6th edition. Newton square.
- Qazi, A., Dikmen, I., & Birgonul, M. T. (2020). Prioritization of interdependent uncertainties in projects. *International Journal of Managing Projects in Business*, 13(5), 913–935. <https://doi.org/10.1108/IJMPB-10-2019-0253>
- Qing, L. I., Rengkui, L. I. U., Jun, Z., & Quanxin, S. U. N. (2014). Quality risk management model for railway construction projects. *Procedia Engineering*, 84, 195–203. <https://doi.org/10.1016/j.proeng.2014.10.426>
- Renault, B. Y., & Agumba, J. N. (2016). Risk management in the construction industry: A new literature review. *MATEC Web of Conferences*, 66, 6–11. <https://doi.org/10.1051/matecconf/20166600008>
- Rezakhani, P. (2011). Fuzzy Risk Analysis Model for Construction Projects. *International Journal of Civil and Structural Engineering*, 2(2), 507–522.
- Rostami, A., Oduoza, C. F., & Rostami, A. (2017). Key risks in construction projects in Italy : contractors 'perspective. *Engineering, Construction and Architectural Management*, 24(3), 451–462. <https://doi.org/10.1108/ECAM-09-2015-0142>
- Rostami, A., Sommerville, J., Wong, I. L., Lee, C., Rostami, A., Sommerville, J., Wong, I. L., & Lee, C. (2015). Risk management implementation in small and medium enterprises in the UK construction industry. *Engineering, Construction and Architectural Management*, 22(1), 91–107. <https://doi.org/10.1108/ECAM-04-2014-0057>
- Salawu, R. A., & Abdullah, F. (2015). Assessing risk management maturity of construction organisations on infrastructural project delivery in Nigeria. *Procedia - Social and Behavioral Sciences*, 172(2006), 643–650. <https://doi.org/10.1016/j.sbspro.2015.01.414>

- Sanda, Y. N., Anigbogu, N. A., Rugu, E. A., & Babas, L. Y. (2020). Critical Risk Factors Associated with Public Private Partnership Housing Projects. 10(1), 42–49. <https://doi.org/10.2478/jepmm-2020-0006>
- Sayed, M., Ahmed, B., El-karim, A., Aly, O., El, M., & Abdel-alim, A. M. (2017). Identification and assessment of risk factors affecting construction projects. *HBRC Journal*, 13(2), 202–216. <https://doi.org/10.1016/j.hbrj.2015.05.001>
- Serpella, A., Ferrada, X., Rubio, L., & Arauzo, S. (2015). Evaluating risk management practices in construction organizations. *Procedia - Social and Behavioral Sciences*, 194(October 2014), 201–210. <https://doi.org/10.1016/j.sbspro.2015.06.135>
- Serpella, A. F., Ferrada, X., Howard, R., & Rubio, L. (2014). Risk management in construction projects : a knowledge-based approach. *Procedia - Social and Behavioral Sciences*, 119, 653–662. <https://doi.org/10.1016/j.sbspro.2014.03.073>
- Siraj, N. B. & Fayek, A. R. (2016). Fuzzy System Dynamics for Modeling Construction Risk Management. *Construction Research Congress*, 1990, 2411–2421.
- Siraj, N. B., & Fayek, A. R. (2019). Risk Identification and Common Risks in Construction: Literature Review and Content Analysis. *Journal of Construction Engineering and Management*, 145(9), 03119004. [https://doi.org/10.1061/\(asce\)co.1943-7862.0001685](https://doi.org/10.1061/(asce)co.1943-7862.0001685)
- Su, G., Hastak, M., Deng, X., & Khallaf, R. (2021). Risk Sharing Strategies for IPD Projects: Interactional Analysis of Participants 'Decision-Making. *Journal of Management in Engineering*, 37(1), 04020101. [https://doi.org/10.1061/\(asce\)me.1943-5479.0000853](https://doi.org/10.1061/(asce)me.1943-5479.0000853)
- Sy, D. T., Likhitrungsilp, V., Onishi, M., & Nguyen, P. T. (2016). Impacts of risk factors on the performance of public-private partnership transportation projects in Vietnam. *ASEAN Journal on Science and Technology for Development*, 6(1), 1–24.
- Szymański, P. (2017). ScienceDirect ScienceDirect Risk management in construction Poland projects Paweł in Risk management construction projects. *Procedia Engineering*, 208, 174–182. <https://doi.org/10.1016/j.proeng.2017.11.036>
- Taofeeq, D. M., Adeleke, A. Q., & Ajibike, W. A. (2020). Human factors influencing contractors 'risk attitudes: A case study of the Malaysian construction industry. *Construction Economics and Building*, 20(1), 96–116. <https://doi.org/10.5130/AJCEB.v20i1.6735>
- Taroun, A. (2014). Towards a better modelling and assessment of construction risk: Insights from a literature review. *International Journal of Project Management*, 32(1), 101–115. <https://doi.org/10.1016/j.ijproman.2013.03.004>
- Taroun, A., Yang, J. B., & Lowe, D. (2011). Construction Risk Modelling and Assessment : Insights from a Literature Review. *The Built & Human Environment Review*, 4(1), 87–97.
- Tesfaye, E., Berhan, E., & Kitaw, D. (2016). A Comprehensive Literature Review on Construction Project Risk Analysis. *International Journal of Risk and Contingency Management*, 5(4), 1–15. <https://doi.org/10.4018/ijrcm.2016100101>
- Tetteh, M. O., Chan, A. P. C., Darko, A., & Nani, G. (2020). Factors affecting international construction joint ventures: a systematic literature review. *International Journal of Construction Management*, 1–45. <https://doi.org/10.1080/15623599.2020.1850203>



- Timofeeva, S. S., Ulrikh, D. V, & Tsvetkun, N. V. (2017). ScienceDirect ScienceDirect Professional Risks in Construction Industry Professional Risks in Construction Industry. *Procedia Engineering*, 206, 911–917. <https://doi.org/10.1016/j.proeng.2017.10.571>
- Toth, T., & Sebestyen, Z. (2015). Time-varying risks of construction projects. *Procedia Engineering*, 123, 565–573. <https://doi.org/10.1016/j.proeng.2015.10.109>
- Wan, J., & Liu, Y. (2014). A System Dynamics Model for Risk Analysis during Project Construction Process. *Open Journal of Social Sciences*, 2, 451–454.
- Wang, J., & Yuan, H. (2016). System Dynamics Approach for Investigating the Risk Effects on Schedule Delay in Infrastructure Projects. *Journal of Management in Engineering*, 1–13. [https://doi.org/10.1061/\(ASCE\)ME.1943-5479.0000472](https://doi.org/10.1061/(ASCE)ME.1943-5479.0000472).
- Wang, Y., Wang, Y., Wu, X., & Li, J. (2020). Exploring the risk factors of infrastructure PPP projects for sustainable delivery: A social network perspective. *Sustainability*, 12, 1–26. <https://doi.org/doi:10.3390/su12104152>
- Wibowo, A., & Taufeek, J. (2017). Developing a self-assessment model of risk management maturity for client organisations of public construction projects: Indonesian context. *Procedia Engineering*, 171, 274–281. <https://doi.org/10.1016/j.proeng.2017.01.335>
- Williams, T. (2017). The Nature of Risk in Complex Projects. *Project Management Journal*, 48(4), 55–66. <https://doi.org/10.1177/875697281704800405>
- Xie, L., Han, T., & Skitmore, M. (2019). Governance of relationship risks in megaprojects: A social network analysis. *Advances in Civil Engineering*, 2019. <https://doi.org/10.1155/2019/1426139>
- Yaseen, Z. M., Ali, Z. H., Salih, S. Q., & Al-Ansari, N. (2020). Prediction of risk delay in construction projects using a hybrid artificial intelligence model. *Sustainability (Switzerland)*, 12(4), 1–14. <https://doi.org/10.3390/su12041514>
- Yirenkyi-fianko, A. B., Chileshe, N., & Chileshe, N. (2015). industry An analysis of risk management in practice: the case of Ghana 's construction industry. <https://doi.org/10.1108/JEDT-04-2012-0021>
- Yisakor S. Ferede, N. X. M. and D. W. T. (2020). A Theoretical Assessment of the Impacts of Poor Risk Management in the Construction Industry - A Case of Ethiopia. *Proceedings of the Creative Construction E-Conference (2020) 016* Edited by: Miroslaw J. Skibniewski & Miklos Hajdu <https://doi.org/10.3311/CCC2020-016>, January. <https://doi.org/10.3311/CCC2020-016>
- Yu, Y., Chan, A. P. C., Chen, C., & Darko, A. (2018). Critical Risk Factors of Transnational Public–Private Partnership Projects: Literature Review. *Journal of Infrastructure Systems*, 24(1), 04017042. [https://doi.org/10.1061/\(asce\)is.1943-555x.0000405](https://doi.org/10.1061/(asce)is.1943-555x.0000405)
- Zhang, Y., & Zhang, S. (2016). Research on the System Dynamics Mechanism of Project Management. *ICCREM 2016: BIM Application and Offsite Construction - Proceedings of the 2016 International Conference on Construction and Real Estate Management*, Wang 1998, 502–507. <https://doi.org/10.1061/9780784480274.059>
- Zou, P. X. Chen, Y. & Chan, T. (2010). Understanding and improving your risk management capability: Assessment model for construction organisations. *Journal of construction engineering and management*. 136 (8), 854-863.

## APPENDIX A

**Table 1: List of articles reviewed**

S/N	Year	Authors	Article Classification	Project Type
1	2011	Taroun, et al.	Review paper	Building Construction Projects
2	2013	Taroun	Review paper	Infrastructure Projects
3	2016	Tesfaye, et al.	Review paper	Building Construction Projects
4	2017	Islam, et al.	Review paper	Building Construction Projects
5	2017	Bahamid & Doh	Review paper	Building Construction Projects
6	2017	Yu, et al.	Review paper	Infrastructure Projects
7	2019	Siraj & Fayek	Review paper	Building Construction Projects
8	2019	Afzal, et al.	Review paper	Building Construction Projects
9	2019	Muthuveeran, et al.	Review paper	Infrastructure Projects
10	2020	Tetteh, et al.	Review paper	Building Construction Projects
11	2020	Nabawy & Khodeir	Review paper	Large Projects
12	2013	Yirenkyi-Fianko & Chileshe	Risk Management Practices	Building Construction Projects
13	2014	Chileshe & Kikwasi	Risk Management Practices	Building Construction Projects
14	2015	Serpell, et al.	Risk Management Practices	Building Construction Projects
15	2016	Renault, et al.	Risk Management Practices	Building Construction Projects
16	2017	jin, et al.	Risk Management Practices	Building Construction Projects
17	2010	Zuo, et al.	Risk Management Maturity	Building Construction Projects
18	2012	Mafakheri, et al.	Risk Management Maturity	Building Construction Projects
19	2013	Mu, et al.	Risk Management Maturity	Infrastructure Project
20	2013	Coetzee & lubbe	Risk Management Maturity	Building Construction Projects
21	2014	Motaleb & Kishk	Risk Management Maturity	Building Construction Projects
22	2015	Salawu & Abdullah	Risk Management Maturity	Infrastructure Project
23	2017	Wibowo & Taufik	Risk Management Maturity	Building Construction Projects
24	2019	Abdulrahman, et al	Risk Management Maturity	Building Construction Projects
25	2010	Kutsch & Hall	Risk Management Process	Building Construction Projects
26	2010	Kululanga & Kuotcha	Risk Management Process	Building Construction Projects
27	2010	Ojo	Risk Management Process	Building Construction Projects
28	2011	Rezakhani	Risk Management Process	Building Construction Projects
29	2011	Ibironke, et al.	Risk Management Process	Building Construction Projects
30	2012	Oyewobi, et al.	Risk Management Process	Building Construction Projects
31	2013	Junior & Carvalho	Risk Management Process	Building Construction Projects
32	2014	Rostami, et al.	Risk Management Process	Building Construction Projects
33	2014	Serpella, et al.	Risk Management Process	Building Construction Projects
34	2014	Qing, et al.	Risk Management Process	Infrastructure Project
35	2014	Irimia-Dieguez, et al.	Risk Management Process	Large Projects
36	2015	Toth & Sebestyen	Risk Management Process	Building Construction Projects
37	2015	Baghdadi & Kishk	Risk Management Process	Aviation Project
38	2015	Boateng, et al.	Risk Management Process	Large Projects
39	2015	Dziadosz & Rejment	Risk Management Process	Building Construction Projects
40	2016	Grabovoy & Orlov	Risk Management Process	Large Projects
41	2016	Rostami & Oduoza	Risk Management Process	Building Construction Projects
42	2016	Park, et al.	Risk Management Process	Large Projects
43	2016	Maina & Mbabazize	Risk Management Process	Building Construction Projects
44	2016	Sy, et al.	Risk Management Process	Infrastructure Project
45	2016	Algathany, et al.	Risk Management Process	Building Construction Projects

46	2017	Szymanski	Risk Management Process	Building Construction Projects
47	2017	Timofeeva, et al.	Risk Management Process	Large Projects
48	2017	Khallaf, et al.	Risk Management Process	Large Projects
49	2017	Maseko	Risk Management Process	Building Construction Projects
50	2017	Oduoza, et al.	Risk Management Process	Building Construction Projects
51	2017	Firmenich	Risk Management Process	Building Construction Projects
52	2017	Abd El-Karim, et al.	Risk Management Process	Building Construction Projects
53	2018	Honsy, et al.	Risk Management Process	Infrastructure Project
54	2018	Odimabo & Oduoza	Risk Management Process	Building Construction Projects
55	2018	Basaif, et al.	Risk Management Process	Building Construction Projects
56	2018	Gupta & Thakkar	Risk Management Process	Building Construction Projects
57	2018	Deng	Risk Management Process	Infrastructure Project
58	2018	Adeleke, et al.	Risk Management Process	Building Construction Projects
59	2018	Keshk, et al.	Risk Management Process	Building Construction Projects
60	2019	Khattak, et al.	Risk Management Process	Building Construction Projects
61	2019	Nawaz, et al.	Risk Management Process	Building Construction Projects
62	2019	Issa, et al.	Risk Management Process	Building Construction Projects
63	2019	Cakmak & Tezel	Risk Management Process	Building Construction Projects
64	2020	Yaseen, et al.	Risk Management Process	Building Construction Projects
65	2020	Chou & Lin.	Risk Management Process	Infrastructure Project
66	2020	Pereira, et al.	Risk Management Process	Building Construction Projects
67	2020	Wang, et al.	Risk Management Process	Infrastructure Project
68	2020	Osman, et al.	Risk Management Process	Building Construction Projects
69	2020	Ferede, et al.	Risk Management Process	Building Construction Projects
70	2020	Sanda, et al.	Risk Management Process	Building Construction Projects
71	2010	Armstrong & McCulloh	Risk Interactions	Building Construction Projects
72	2012	Fang, et al.	Risk Interactions	Large Proects
73	2012	Boateng, et al.	Risk Interactions	Large Projects
74	2014	Wan & Liu	Risk Interactions	Building Construction Projects
75	2015	Marle	Risk Interactions	Building Construction Projects
76	2015	Mhatre, et al.	Risk Interactions	Building Construction Projects
77	2015	Boateng, et al.	Risk Interactions	Large Projects
78	2016	Siraj, Fayek	Risk Interactions	Building Construction Projects
79	2016	Wang & Yuan	Risk Interactions	Infrastructure Project
80	2016	Zhang & Zhang	Risk Interactions	Building Construction Projects
81	2017	Williams	Risk Interactions	Large Projects
82	2017	Dandaje, et al.	Risk Interactions	Building Construction Projects

83	2017	Boateng, et al.	Risk Interactions	Building Construction Projects
84	2017	Xu, et al.	Risk Interactions	Building Construction Projects
85	2017	Ongkowijoyo & Dolo	Risk Interactions	Infrastructure Project
86	2018	Kimiagari & Keivanpour	Risk Interactions	Building Construction Projects
87	2018	Chatterjee	Risk Interactions	Building Construction Projects
88	2019	Xie, et al.	Risk Interactions	Large Projects
89	2020	Qazi, et al.	Risk Interactions	Building Construction Projects
90	2020	Taofeek, et al.	Risk Interactions	Building Construction Projects
91	2020	Su, et al.	Risk Interactions	Large Proects
92	2020	Guan, et al.	Risk Interactions	Building Construction Projects
93	2020	Erol, et al.	Risk Interactions	Large Projects
94	2021	Korytarova & Hromadka	Risk Interactions	Infrastructure Project

---



---

# SOCIAL PROCUREMENT AND SUSTAINABILITY IN THE NIGERIAN CONSTRUCTION INDUSTRY

Francis O. Okeke<sup>1</sup> and Rosemary C. Nnaemeka-Okeke<sup>2</sup>

<sup>1,2</sup>*Department of Architecture, University of Nigeria, Nigeria*

Social sustainability transition in the construction sector seeks to improve safety and health of workers, gainful employment and total inclusiveness. However, one less debated domain within this framework is how employment requirements provide opportunities for the socially disadvantaged such as the poorly educated, youths, immigrants, and disabled individuals to be employed in the construction industry. In Nigeria, there are over 86.9 million people living in extreme poverty. Hence, social procurement as a strategic tool should be used to create employment for these disadvantaged people in the construction sector. Drawing on a systematic review of relevant literature using Prisma to improve the reporting of reviews and analyses, this research examines social procurement practices in other countries with the aim to fill the gap in literature for the Nigerian construction industry highlighting the barriers and strategies for diffusing the approach into the construction industry. The outcome of the result initiates a research domain and promote sound academic debate towards improving total inclusiveness in the Nigerian and African built environment. It was discovered from the results of the study that barriers to social procurement and sustainability in other climes are replica of the Africa's and Nigerian built industry with women having been the most socially disadvantaged groups. It concludes and advocates for a complete overhaul of procurement policies in Nigeria to accommodate the socially disadvantaged groups providing an alternative solution to the increasing shortage of skilled labour force in the construction industry in Nigeria.

Keywords: construction industry, social procurement, social sustainability, socially disadvantaged groups, total inclusiveness

## INTRODUCTION

Social sustainability seeks to improve safety and health of workers, gainful employment, and total inclusiveness. The society and clients in the construction industry are increasingly expecting that the industry should contribute more positively to the communities in which it builds. This have set more challenges for the industry not to concentrate only on productivity and energy efficiency, but also impact significantly to the social wellbeing of the people living in the communities where they are situated in. The UN 2030 agenda for sustainable development which seeks to eradicate poverty and achieve sustainable development for all by 2030

---

<sup>1</sup> ogochukwu.okeke@unn.edu.ng

<sup>2</sup> rosemary.nnaemeka-okeke@unn.edu.ng

(Nnaemeka-okeke et al., 2020), encapsulate the social dimension of sustainability which aims to improve the safety and health of workers; reduce employment discrimination and promote total inclusiveness. But this has always been overshadowed by the environmental and economic dimensions (Hutchins and Sutherland, 2008).

Social procurement being a social policy tool, is used by government, businesses, and the society to create social value. Social value not being a new concept, has of recent, increased interest in the construction industry because of new social procurement legislation around the world with an increased acceptance of the need to ensure construction projects provide social value, rather than simply economic value. (Raiden et al., 2018). Government and socially responsible private clients seek to place new requirements on construction firms to demonstrate how their projects will leave a positive legacy in the communities in which they are built (Burke and King 2015, Petersen and Kadefors 2016, Barraket and Loosemore 2017).

In South Africa, The Preferential Procurement Policy Framework Act 5 of 2000 and the Preferential Procurement Regulations of 2001 establishes the obligation of government to award preferential procurement points to enterprises owned by historically disadvantaged persons, including females (ppp.worldbank.org). This policy, therefore, accommodates certain categories of people in the country who have been formerly disadvantaged in the procurement process such as the poorly educated, youths, immigrants, females and the disabled. However, studies in Nigeria have shown that the policy mechanisms for sustainability in Social procurements in Nigeria is inadequate (Olanrewaju et al. 2014; Ogunsanya et al. 2016; Oyewobi et al 2017; Faremi et al. 2017). The Nigerian situation presents a peculiar case with galloping population issues and has been described as been fragile (Okeke et al. 2020). The public procurement Act PPA 2007 which is a tool for industrial policy or used to pursue sustainable development goals (OECD, 2015; UNIDO, 2017), does not accommodate these disadvantaged groups. Hence, not achieving social value. The Public Procurement Act (Amendment) Bill, of 2019 (SBs 106,109, and 158) only reviewed the mobilization fee for contractors, created an e-procurement model and provided a time frame for procurement processes (Policy and Legal Advocacy Centre 2019).

Therefore, the paper identifies how employment requirements provide opportunities for the socially disadvantaged such as the poorly educated, youths, immigrants, and disabled individuals to be employed in the Nigerian construction industry through social procurement practices. The objectives perused in this study are (a) highlight the barriers militating social procurement and sustainability practice (b) to identify strategies for integrating these practices into the construction industries in Nigeria. The outcome of the result will initiate a research domain and promote sound academic debate towards improving total inclusiveness in the Nigerian and African built environment and provide an alternative solution to the increasing shortage of skilled labour force in the construction industry. It will also be a focus for government in future social procurement policies.

## **LITERATURE REVIEW**

This section starts with a conceptualization of the theory on social procurement and Social sustainability followed by the evolving of a conceptual model and an in-depth discussion of the barriers and strategies for integrating these practices into these construction industries that have been identified from the literature.

### **Theory on social procurement**

Every procurement process needs to have economic, environmental, and social Impact. Social procurement refers to the activities and processes related to the purchase of goods, services and works in public, private or nonprofit sector organizations to generate positive social impacts (Ingrid Burkett, 2010). This process has often focused on ensuring that supply chains generate positive social impacts such as local employment and training, diversity and equality outcomes, and social inclusion. According to Ingrid Burkett (2010), the three ways in which term social procurement is used in organizations are as follows:

- To screen their supply chains to ensure that they do no harm with regards to labour conditions and human rights of workers;
- To add value to the purchase by linking the generation of social impact with the purchase of goods, services and works.
- To refer to the procurement of social services

Therefore, social procurement in this context refers to the inclusion of social value into the procurement of goods, services and construction works.

According to McCrudden (2004), public contracts were linked to labour and employment standards in some countries like the United States or in United Kingdom in the 19th century. Afterwards, government used public contracting to reduce discrimination against women, racial minorities and the disabled. In the construction industry, government can create social value by mandating contractors to employ or purchase from these disadvantaged groups. Studies on social procurement related to employment have for example focused on benefitting local, small, or minority-owned businesses (Walker and Preuss, 2008; Loader, 2016, Loosemore and Denny-Smith, 2016). With few studies on social procurement in specific industries, the construction industry has more potentials to address social challenges through employment and training despite the challenges faced in implementing such policies. Recent research by Petersen (2018) and Troje and Gluch (2019) looked at the institutional changes and the new employment requirements imposed by emerging social procurement policies but less is known about the specific barriers to employment faced by the disadvantaged groups being targeted.

In Sweden, there is a successful use of social procurement in the construction industry to integrate immigrant populations into the labour market (Peterson & Kadefors 2016). Similarly, social procurement has also been used in the United Kingdom to simultaneously provide employment opportunities for women and address gender imbalances in the male-dominated construction industry through projects such as Women in Construction. According to Clarke and Gribling (2008),

there was no evidence of any positive discrimination for women or other target groups or any distinct measures designed to ensure that people from different groups were not discriminated against. Australia is not left out of this success as the Victorian Social Procurement Framework requires all Victorian Government departments and agencies to consider employment and job readiness targets for these socially disadvantaged groups. (Victoria State Government 2018). The refusal of construction industries to comply with government policies for employment of these targeted groups in countries such as Australia, United Kingdom, Canada, and South Africa attracts a penalty of being struck off tender lists with government agencies. (Australian Indigenous Procurement Policy 2015).

### **Social sustainability concept**

Troje & Gluch (2019) described social procurement as social sustainability concept as it involves measures related to health and safety, buying from women-owned and minority-owned businesses, and employment creation for disadvantaged groups. The concept of social sustainability with regards to construction projects, means meeting the needs of the industry, users, and communities where each of these communities have a unique relationship with the project and different expectations and interests from the project (Almahmoud, & Doloji, 2018). Thus, the development of construction projects has the capacity to enhance social sustainability (Du Plessis, 2002). Social sustainability also refers to corporate social responsibility (CSR) which indicates the ethics and social responsibilities, amongst stakeholders resulting from corporate activities with a social dimension (Waddock and Graves, 1997). Safarzag (2017) defined CSR concept as a legal requirement for a company which includes continued commitment toward the community. This increases the efficiency and productivity of the company thereby maximizing its shareholders' profit while integrating the community's ethical and environmental expectations into the company economic processes.

Eizenberg & Jabareen (2017), proposed a conceptual framework for social sustainability that seeks to enhance the protection of people, regardless of color, origin, culture, or socio-economic status, against risk by fostering the adaptation of just and equitable social, economic, and environmental policies. In the same vein, the triple bottom line theory (TBL) founded by John Elkington can also be referred to as CSR framework with sustainability as its main aim (Brin, and Nehme, 2019). It incorporates the three dimensions of sustainability to achieve continuous profits and long-term social and environmental projects. Therefore, many corporations and nonprofit organizations have adopted the TBL sustainability framework in performing CSR projects.

In the study of the current procurement practices in the Nigerian construction industry, Oyewobi et al., (2017) concluded that Nigeria is yet to embrace the triple bottom line of sustainability initiatives as it places more emphasis on the economic aspect of procurement with social aspect being the most neglected. We would, therefore, like to suggest a conceptual framework that integrates the social aspect of sustainability to the economic and environmental aspect of sustainability while linking the social disadvantaged groups to of social procurement.



### Conceptual model

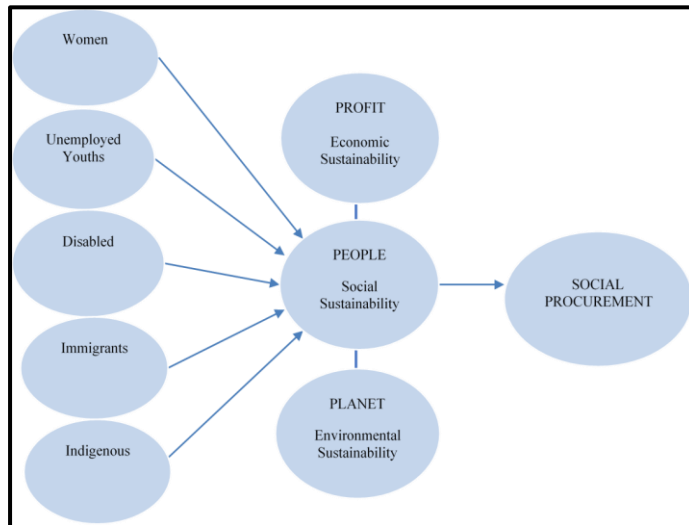

Figure 1: Conceptual model by Author

Figure 1 shows the conceptual model where the social sustainability links the social disadvantaged people (women, unemployed youths, disabled, immigrants and indigenous) to social procurement, Here, the 3 dimensions of sustainability refers to the Triple Bottom Line Theory (TBL). The social dimension of sustainability refers to the people (the disadvantage group). When they are given the opportunity for inclusion, social sustainability is achieved.

## METHODS

The study employed a qualitative research approach and adopted a literature review research design. The Preferred Reporting Items for Systematic Reviews and Meta-Analyses (PRISMA) was used in this research. We searched google scholar database for articles within the year range 2000-2021 with the following keywords: "social procurement"; "social sustainability", "construction industry" and "social disadvantaged groups". Citations from relevant publications were checked to identify the relevant articles. Studies that involved the construction industry and the different social disadvantaged groups in developed countries and developing countries were used. 2750 papers resulted from the search with their titles and abstracts of all references and relevant articles retrieved. Full texts were screened independently, and 1080 papers were retrieved after duplicates were removed. 155 Full text articles were assessed for eligibility while 925 papers were excluded. 132 full text articles were further excluded as they are about social sustainability without involving procurement leaving 32 studies in the qualitative synthesis. Out of the 32 studies, 23 studies were used in the review while 7 studies were further excluded because their abstracts did not reflect the subject topic being searched while 2 studies were also excluded because the full article was not written in English. All reasons for exclusion were documented into a PRISMA flowchart. Using thematic content analysis, data were analyzed and result presented with text and tables. Inferences were deduced based on the results of the study.

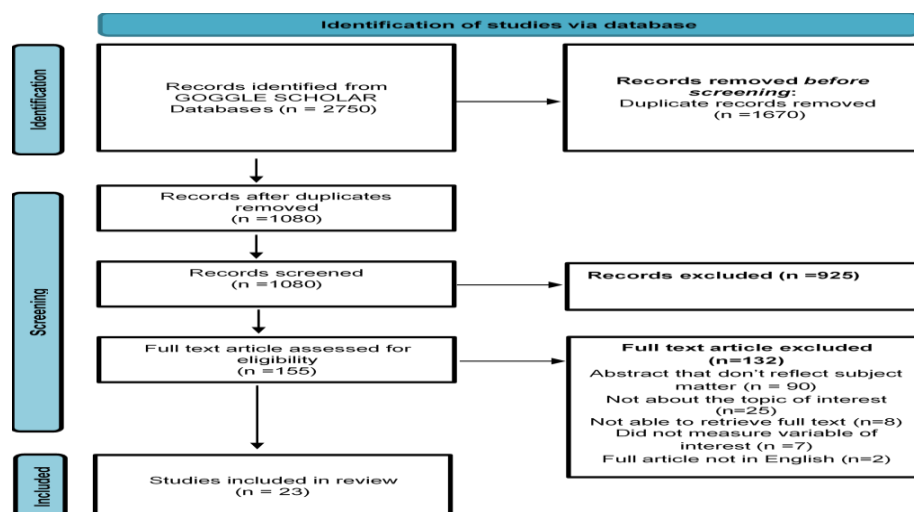

Figure 2: PRISMA diagram showing the process of identification of the studies used in the review.

## ANALYSIS AND RESULT

Table 1: Overviews of the literature on the barriers to social procurement of disadvantaged groups

S/N	Author	Methodology	Location	Research design	Findings
1	Newton and Ormerod (2005)	Qualitative study	UK	Survey	No appropriate policies and practices were in place to support disabled job applicants through the recruitment process. It is likely that contractors are not fulfilling their obligations under the Disability Discrimination Act
2	Amaratunga et al (2006)	Quantitative and Qualitative	UK	Literature review	women are confronted by a significant number of barriers, beginning with difficulties in joining the field of construction through to capturing the most senior position in the organization's hierarchy.
3	Ginige et al (2007)	Quantitative	UK	Literature review	The negative image of the construction industry stands as a barrier for the recruitment and retention of women. Welfare facilities (such as medical support and childcare) are also inadequate.
4	Clarke and Gribling (2008)	Quantitative and Qualitative	UK	semi-structured interviews	No evidence of any positive discrimination for women or other target groups or any distinct measures designed to ensure that people from different groups were not discriminated against.
5	Shier et al. (2009)	Qualitative	Canada	interview	workplace and employer discrimination are the primary factors impeding people with disability from securing and maintaining employment in the labour market.
6	Clarke and Wall (2009)	Mixed method	UK and Netherlands	Interviews and questionnaires	Policy in each country addresses the nature of exclusion in different ways. The conclusion drawn is that a sector-specific approach is needed if disability policy in Britain is to be more in tune with the social model—as apparent from the comparison with the Netherlands.
7	Chan and McCabe (2010)	Quantitative	UK and Europe	Literature review	There were several emerging disparities in terms of age, gender, employment status, and employment conditions. This is due to the marginalization of youths in recruitment into the sector, resilience of women in weathering unemployment, proliferation of non-traditional forms of employment relationship and decline of working conditions.
8	Ormerod and Newton (2013)	participatory research approach		interviews	There is need for inclusive approaches within the construction industry by creating awareness that disabled young people can be employed within construction industry while dispelling of the myths that construction is for able-bodied, fit, men.
9	Quaigrain et al. (2014)	Quantitative	Canada	Literature review	The construction industry's disability management practices remain inadequate. Disability management continues to be a burden to construction employers for the most part, making it difficult to challenge traditional perceptions.

**Table 1 Cont'd: Overviews of the literature on the barriers to social procurement of disadvantaged groups**

10	Akomolafe & Mohammed (2015)	Quantitative	Nigeria	Literature review	women are confronted by a significant number of barriers, especially joining the industry through the most senior position in the organization's hierarchy in order to create avenue for other women. increased loyalty to the employers as result of better conditions and pay. Although all the foreigners were regarded to be disciplined productive workforce, their perception of acceptance differed by their country of origin.
11	Khatleli (2015)	Qualitative	South Africa	case studies and interviews	Changes are needed to traditional procurement practices. social value requirements were to be incorporated into the existing subcontracts which is a challenge to the supply chain giving a negative stereotype of the disadvantaged groups which the social enterprises employ.
12	Loosemore (2015)	Quantitative	UK	interviews and documentary analysis	Findings suggest that the changes in the construction industry can be understood as an ongoing institutionalization process, where the institutional work of procurement- and construction actors are reshaping old institutional logics towards a more socially service-oriented sustainable industry.
13	Petersen and Kadefors, (2016)	Quantitative	Sweden	Case studies	social procurement policies which is aimed at helping Indigenous people can inadvertently create negative social outcomes and even disempower the very groups they are designed to help.
14	Denny-Smith & Loosemore (2017)	quantitative	Australia	Theoretical framework	social procurement in construction is currently compliance-driven, confined to low value and low risk activities and delivered mainly by existing industry incumbents who do not understand how to deliver social value, or by micro-organisations that do, but which suffer from a lack of scale and opportunity.
15	Reid and Loosemore, (2017)	Qualitative		semi-structured interviews	The current procurement practices in the Nigerian construction industry is yet to embrace the triple bottom line of sustainability initiatives as it places more emphasis on the economic aspect of procurement. The most severe barrier to sustainability is lack of government commitment.
16	Oyewobi, et al (2017)	Mixed method	Nigeria	Literature review, interview and document analysis	The barriers which influenced female under-representation in the Nigerian construction industry include; male dominance, family commitments, and long working hours.
17	(Akinsiku & Ajala, 2018)	stratified random sampling	Nigeria	survey questionnaire literature review	Return-to-work, disability and injury management practices are the most important indicators while physical accessibility and claims management practices are the least important
18	Quaigrain & Issa (2018)	exploratory and quantitative	Canada	review of literature	The results demonstrate the conceptual merit of Furneaux and Barraket's (2014) typology in a construction industry context by highlighting the different constraints on social value creation for each typology.
19	Loosemore et al. (2019)	conceptual framework	Australia	semi-structured interviews	social procurement can alleviate various forms of inequality both in people's lives and in the communities in which they live. However, significant implementation challenges must be overcome to ensure that the social benefits generated are distributed equitably across various stakeholders involved in the procurement process.
20	Mupanemunda, M (2019).	Qualitative	Australia	Content analysis, descriptive statistics, and logistic regression were applied	Overall, the project shows that national, sector and economic context are more important in understanding labour conditions in Africa than the country origin of the firm itself.
21	Carlos Oya (2019)	sequential mixed methods	Africa	Comparative framework.	Subcontractors see significant business risks associated with safety, productivity and costs with disengaged youth as the highest risk cohort, followed by migrants and refugees, people suffering disability, ex-offenders, women and Indigenous workers and employment priorities reflect these perceptions.
22	Loosemore et al. (2020)	Qualitative	Australia	survey	Organizational and industrial barriers negatively affect corporate social responsibility practices. Also, education, training and government support could help construction firms in reducing the impact of such barriers.
23	Pham et al (2021)	empirical	Vietnam	survey questionnaire	

Source: Authors

The result of table 1 shown above revealed that just view few studies on social procurement and sustainability have been conducted in Africa and particularly Nigeria. In presenting our findings, the result is based on the review of related articles which indicates the challenges faced by the social disadvantaged in social procurement in construction industries. The barriers and challenges identified in other climes are not different from the perceived obtainable barriers in the African and Nigerian settings. Of all the disadvantaged groups targeted by new social procurement policies, women represent the most well researched group in construction industries with the focus on professional than tradeswomen or disabled women (Amaratunga et al., 2006; Akinsiku & Ajala, 2018; Akomolafe & Mohammed, 2015; Loosemore et al., 2020). As revealed in table 2 below, they are also the group with the most barriers as confirmed by the findings of Amaratunga et al., (2006); Akomolafe & Mohammed (2015); Akinsiku & Ajala, (2018) and this human species account for a reasonable number of Nigeria's total population. The male dominated image and culture of the construction industry is a barrier for employment of women. This is in line with Fielden et al., (2000) as reported in Akomolafe & Mohammed (2015), where the industry's poor image is a reason why so many people, regardless of gender, are uninterested in a career in construction. Also, women have been continuously marginalized in Nigerian construction industry as reported by Akomolafe & Mohammed (2015) and Akinsiku & Ajala, (2018) as they are always fewer than men in such industries. This Research has identified the barriers to employment which is the cause of this underlying problem in the construction industry. Therefore, women should be given the significant policy focus in Nigeria like in Australia as reported by Loosemore et al (2020) where gender diversity in the construction industry is now recognized.

The study also discovered that another important barrier of the disadvantaged group that ranked highest is lack of government commitment. The current procurement practices in the Nigerian construction industry is yet to embrace the triple bottom line of sustainability because it places more emphasis on the economic aspect of procurement than the social or environmental. This corroborates the findings of Oyewobi et al., (2017). Also, lack of support from government is a barrier to the employment of the social disadvantaged group which suggests that social procurement legislation is not being accompanied by the necessary support structures. The same can be said about the 2007 procurement act in Nigeria. This finding is in line with Newton and Ormerod (2005) where No appropriate policies and practices were in place to support disabled job applicants through the recruitment process which suggest that there were no strong policies or penalties. Therefore, it was very likely that contractors were not fulfilling their obligations under the Disability Discrimination Act. This gives us an idea of where policy makers should focus on when implementing the social procurement policy. The table 2 presented below summaries the categories of the five socially disadvantaged groups, various barriers identified in literature and suggested strategies that can be diffused into the Nigeria's construction industry to become socially responsible.

**Table 2: Summary of barriers and strategies for the employment of socially disadvantaged groups in Nigeria**

DISADVANTAGED GROUPS	BARRIERS	STRATEGIES
Indigenous People Disabled. Unemployed Youths Women Immigrants &Refugees	Lack of support. Poorly designed & implemented policies. Non-enforcement of gender equity & diversity policies Cost of training Cost of supervision, Career knowledge Inability to fit in Low technical skill Lack of qualifications Lack of mentorship & role models Reduced apprenticeships / training Poor education Wage differentials Recruitment practices Family commitments Cultural differences Cause of conflict Stigmatization/discrimination General view of women inability to work in construction industries. Harassment Male-dominated structure Sexism Health needs Literacy/numeracy Perceived safety Poor work quality Poor productivity Productivity risks Risk to reputation Unreliability Increasing workplace casualization, Long working hours Work commitment Working environment Modifying workplace	Education and Training Encourage Best Practices Improved Compliance and Efficiency. Reduced Unemployment, Learning About Social Procurement and Employment-Creating Practices, Lowered Maintenance Costs, Reduced Welfare Costs, Opportunities for Recruitment Use of Contract Clauses.

Source: Authors

## CONCLUSION

This research examines social procurement practices in the Nigerian construction industry highlighting the barriers and strategies for diffusing the approach into the construction industry to achieve social sustainability. Based on a review on existing literature on the disadvantages group affected by social procurement policies in other countries with the woman group review from Nigeria, our findings indicate that priorities in hiring with regards to number of barriers (woman, unemployed youths, disabled, immigrants, indigenous), strongly reflects policy focus which the Nigerian Government should implement. It was discovered that barriers to social procurement and sustainability in other climes are replica of the Africa's and Nigerian built industry with women having been the most socially disadvantaged

groups. There is no doubt that social procurement is an effective way for the public, private and not-for-profit sectors to achieve social value and integrate Corporate Social Responsibility (CSR) into any organizational activity. However, to fully utilize the opportunities presented by social procurement policies, much work needs to be done to address the barriers faced by various disadvantaged groups. The potential impact of this research is that it will contribute to social sustainability and provide an alternative solution to the increasing shortage of skilled labour force in the construction industry.

## REFERENCES

- Akinsiku, O., & Ajala, N. (2018). An Investigation of Barriers to Females 'Involvement in the Nigeria Construction Industry. October 2018, 2(2), pp.171-180.
- Akomolafe, M. A., & Mohammed, M. A. (2015). Gender Barrier in Construction Industry: A Review of Women Involvement. *International Journal of Modern Management Sciences*, 2015, 4(1):1-10
- Almahmoud, E., & Doloi, H. K. (2018). Assessment of Social Sustainability in Construction Projects Using Social Network Analysis. *Journal of International Business Research and Marketing*, 3(6), 35-46.
- Brin, P., & Nehme, M. (2019). Corporate Social Responsibility: Analysis of Theories and Models. *Eureka: Social and Humanities*, 5, pp.22-30.
- Barraket, J., & Loosemore, M. (2017). Co- creating social value through cross sector collaboration between social enterprises and the construction industry. *Construction Management and Economics*, 36(7): 394– 408.
- Burke, C., & King, A. (2015). Generating social value through public sector construction procurement: a study of local authorities and SMEs. In: A. Raiden and E. Aboagye-Nimo, eds. *Proceedings 31st annual ARCOM conference*, 7–9 September 2015. Lincoln, UK: Association of Researchers in Construction Management, 387–396.
- Chan, P. W., & McCabe, S. (2010). Emerging disparities: Exploring the impacts of the financial crisis on the UK construction labour market. In: Egbu, C (Ed.) *Proceedings of the 26th Annual ARCOM Conference*, 6-8 September 2010, Leeds, UK Association of Researchers in Construction Management, Vol 1, 523-32.
- Clarke, L., & Wall, C. (2009). A woman's place is where she wants to work': barriers to the entry and retention of women into the skilled building trades', in *Scottish Labour History*, Vol. 44, pp. 16-39
- Clarke, L., & Gribling, M. (2008). 'Obstacles to diversity in construction: the example of Heathrow Terminal 5 'in *Construction Management and Economics*, October 26/10, pp 1055-1065
- Eizenberg, E., & Jabareen, Y. (2017). Social Sustainability: A New Conceptual Framework. *Sustainability*, 9(1), p.68.
- Elkington, J. (1998). Partnerships from cannibals with forks: The triple bottom line of 21st-century business. *Environmental Quality Management*, 8 (1), 37–51. doi: <https://doi.org/10.1002/tqem.3310080106>
- Esteves, A. M., & Barclay, M. (2011). Enhancing the benefits of local content: integrating social and economic impact assessment into procurement strategies, *Impact Assessment and Project Appraisal*, 29:3, 205-215,

- George Denny-Smith, Megan Williams, & Martin Loosemore. (2020). Assessing the impact of social procurement policies for Indigenous people. *Construction Management and Economics* 38:12, pages 1139-1157.
- Ginige, K. N., Amaratunga, R. D. G., & Haigh, R. (2007) Improving construction industry image to enhance women representation in the industry workforce. In: Boyd, D (Ed) *Procs 23rd Annual ARCOM Conference, 3-5 September 2007, Belfast, UK*, Association of Researchers in Construction Management, 377-385.
- Hutchins, M., & Sutherland, J. (2008). An exploration of measures of social sustainability and their application to supply chain decisions. *Journal of Cleaner Production*, 16(15), pp.1688-1698.
- Khatleli, N. (2015) The impact of nativist exclusion on the migrant labourers in the South African construction industry In: Raidén, A Band Aboagye-Nimo, E (Eds) *Procs 31st Annual ARCOM Conference, 7-9 September 2015, Lincoln, UK*, Association of Researchers in Construction Management, 217-226.
- Loader, K. (2016). Is public procurement a successful small business support policy? A review of the evidence. *Environment and planning C: government and policy*, 31 (1), 39–55.
- Loosemore, M. (2015). Social procurement in UK construction projects. *International Journal of project Management*, 34(2), pp.133-144.
- Loosemore, M., & Denny-Smith, G. (2016) Barriers to indigenous enterprise in the Australian construction industry. In: P.W. Chan and C.J. Neilson, eds. *Proceedings of the 32nd Annual ARCOM Conference, 5–7 September 2016, UK*. Manchester, UK: Association of Researchers in Construction Management, 667–676
- Loosemore, M., & Reid, S. (2018). The social procurement practices of tier-one construction contractors in Australia. *Construction management and economics*, 37 (4), 183–200.
- McCrudden, C. (2004). Using public procurement to achieve social outcomes. *Natural Resources Forum*, 28(4), pp.257-267.
- Martin Loosemore, Suhair Alkilani & Robert Mathenge (2020) The risks of and barriers to social procurement in construction: a supply chain perspective, *Construction Management and Economics*, 38:6, 552-569, DOI: 10.1080/01446193.2019.1687923
- Mupanemunda, M. (2019). Social procurement: Creating employment opportunities through purchasing expenditure. Research & Policy Centre.
- Pham, H., Pham, T., & Dang, C. N. (2021), "Barriers to corporate social responsibility practices in construction and roles of education and government support", *Engineering, Construction and Architectural Management*, Vol. ahead-of-print No. ahead-of-print. <https://doi.org/10.1108/ECAM-03-2020-0199>
- Newton, R., & Ormerod, M. (2005). Do disabled people have a place in the UK construction industry? *Construction Management and Economics*, 23 (10),
- Nnaemeka-Okeke R. C., Okeke, F. O., & Sam-Amobi, C. (2020) The 2030 Agenda for Sustainable Development in Nigeria: The Role of the Architect. *Science, Technology & Public Policy*. Vol. 4, No. 1, , pp. 15-21. doi: 10.11648/j.stpp.20200401.13
- Okeke, F. O., Eziyi, I. O., Udeh, C. A., & Ezema, E. C. (2020), City as Habitat: Assembling the fragile city. *Civil engineering Journal* 2020;6(6):1143-1154. doi: <http://dx.doi.org/10.28991/cej-2020-03091536>.

- Ogunsanya, O. A., Aigbavboa, C. O., & Thwala, D. W. (2016) Towards an integrated sustainable procurement model for the Nigerian construction industry: a review of stakeholders 'sanitization with current regimes. 9th cidb Postgraduate Conference February 2-4, 2016, Cape Town, South Africa.
- Ormerod, M., & Newton, R. (2013), "Construction as a career choice for young disabled people: dispelling the myths", *Construction Management and Economics*, Vol. 31 No. 8, pp. 928-938, doi: 10.1080/01446193.2013.777465.
- Oya, C., & Schaefer, F. (2019). Chinese firms and employment dynamics in Africa: A comparative analysis. IDCEA Research Synthesis Report, SOAS, University of London
- Oyewobi, O. L., Ija I. M., & Jimoh, R. A. (2017) Achieving Sustainable Procurement Practices in the Nigerian Construction Industry: Examining Potential Barriers and Strategies. *ATBU Journal of Environmental Technology* 10, 2, December 2017
- Petersen, D., & Kadefors, A. (2016) Social Procurement and Employment Requirements in Construction. In: P W Chan and C J Neilson (Eds.) *Proceedings of the 32nd Annual ARCOM Conference*, 5-7 September 2016, Manchester, UK, Association of Researchers in Construction Management, Vol 2, 1045-1054.
- Public procurement is a powerful tool for sustainable development – UN report. 08 September 2020. <https://unctad.org/news/public-procurement-powerful-tool-sustainable-development-un-Report>.
- Quaigrain, R. A., Winter, J., & Issa, M. H. (2014) A critical review of the literature on disability management in the construction industry in: Raiden, A B and Aboagye-Nimo, E (Eds) *Procs 30th Annual ARCOM Conference*, 1-3 September 2014, Portsmouth, UK, Association of Researchers in Construction Management, 1121-1130.
- Quaigrain, R. A., & Issa, M. H. (2018), "Development and validation of disability management indicators for the construction industry", *Journal of Engineering, Design and Technology*, Vol. 16 No. 1, pp. 81-100, doi: 10.1108/JEDT-04-2017-0032.
- Raiden, A., Loosemore, M., King, A., & Gorse, C. (2019). *Social Value in Construction*. 1st ed. Abingdon: Routledge 2 Park Square, Milton Park and by Routledge 52 Vanderbilt Avenue, New York, NY 10017, p.10.
- Reid, S., & Loosemore, M. (2017) Motivations And Barriers To Social Procurement In The Australian Construction Industry In: Chan, P W and Neilson, C J (Eds) *Proceeding of the 33rd Annual ARCOM Conference*, 4-6 September 2017, Cambridge, UK, Association of Researchers in Construction Management, 643-651.
- Reforming public procurement: progress in implementing the 2015 OECD recommendation. <https://www.oecd.org/governance/public-procurement/>
- Senate Passes the Public Procurement Act (Amendment) Bill, 2019 - Policy and Legal Advocacy Centre. Policy and Legal Advocacy Centre - Promoting Good Governance and Citizens' Access. (2020, January 4). <https://placng.org/i/senate-passes-the-public-procurement-act-amendment-bill-2019/>.
- Shier M., Graham J. R., & Jones M. (2009), 'Barriers to employment as experienced by people with disabilities: A qualitative analysis in Calgary and Regina Canada', *Disability & Society* 24(1), 63-75. 10.1080/09687590802535485
- Troje, D., & Gluch, P. (2019) Social Procurement in the Real World: How Employment Requirements Unfold in Construction Projects In: Gorse, C and Neilson, C J (Eds) *Proceedings of the 35th Annual ARCOM Conference*, 2-4 September 2019, Leeds, UK, Association of Researchers in Construction Management, 24-33.



- The Victorian Social Procurement Framework in Australia- Victoria state government 2018.  
<https://www.buyingfor.vic.gov.au> › files › 2018-08
- United Nations Development Programme (UNDP) 2006, Human development report 2006: beyond scarcity: power, poverty and the global water crisis, Palgrave Macmillan, New York.
- Waddock, S. A., & Graves, S. B. (1997) The corporate social performance-financial performance link. *Strategic Management Journal*, 18 (4), pp. 303-319
- Walker, H., & Preuss, L. (2008) Fostering sustainability through sourcing from small businesses: public sector perspectives. *Journal of cleaner production*, 16 (15), 1600–1609



# SOCIO-PSYCHOLOGICAL MOTIVATIONAL NEEDS OF UNSKILLED WOMEN WORKING IN NIGERIA'S CONSTRUCTION INDUSTRY

Seun Micheal Oloruntoba<sup>1</sup> and Ayokunle Olubunmi Olanipekun<sup>2</sup>

<sup>1</sup>*Quantity Surveying Department, Federal University of Technology, Akure, Nigeria.*

<sup>2</sup>*Quantity Surveying, University of Wolverhampton, Wolverhampton, England, United Kingdom*

The construction sites are characterised by poor planning, deregulation and poor protection in the Nigerian construction industry. This is demotivating for unskilled women workers who are unable to work effectively under such site characteristics. To address the problem, women workers need to be motivated according to the socio-psychological challenges and needs that help them to work effectively. This study explores the motivation of unskilled women site workers with an emphasis on their social and psychological challenges and needs using the qualitative research methodology. It involves a face-to-face interview of nineteen (purposively selected) unskilled women working across different construction project sites in Akure, Ondo State, Nigeria. The data obtained were analysed using the combination of inferential statistics and thematic analysis. The findings reveal the women's 'prevalent challenges on construction sites, including sexual harassment, verbal abuses, unfavourable working conditions, and stress. The findings also reveal the preference of the women for financial incentives to help them overcome the prevalent challenges and increase their morale and effectiveness at work. This study concludes that unskilled women workers can be motivated to work effectively by addressing their socio-psychological challenges and needs. This study is unique by linking women workers 'motivation to unfavourable site characteristics in a developing country. Therefore, the findings in this study can be adapted to other developing countries to motivate unskilled women working on construction sites.

Keyword: challenges, construction sites, motivation, needs, unskilled women workers

## INTRODUCTION

Motivation helps people to achieve their goals (Monese, 2012). It has been described as both internal and external driving forces that produce the willingness to perform an act to a conclusive end (Nnabuife, 2009). As a process, motivation arouses, energizes, channels, and sustains behaviour and performance into a specific course of action. In the construction industry, the motivation of construction workers encourages them to do work (Steers et al., 2004). Therefore,

---

<sup>1</sup> oloruntobaseun92@gmail.com

<sup>2</sup> a.olanipekun@wlv.ac.uk

the motivation of construction workers has become a policy action-point for supervisors to enhance job efficiency (Shadier et al., 2009). More broadly, by enhancing the willingness of construction workers to work, motivation improves the construction industry efficiency (Shadare, 2009). Also, where motivation is lacking, construction productivity suffers (Monese and Thwala, 2009).

In developing countries like Nigeria, unskilled women workers experience demeaning conditions on construction sites (Ahuja et al., 2012). Unlike men workers, the unskilled women construction workers need to combine tedious construction tasks such as loading and lifting building materials with active family life on construction sites. Azhar and Griffin (2013) state that this can be challenging for unskilled women workers to produce expected productivity levels in construction sites. For instance, owing to lacking regulation, unskilled women workers have been found to handle their babies while working on construction sites. This piles pressure on the women throughout the long hours of work and without rest in most cases (Rajanna, 2015). According to Anvekar et al. (2015), the tedious workload, extremely long work hours and intense pressure to work harder leaves unskilled women workers physically and emotionally drained. Consequently, these experiences (mentioned above) create social and psychological challenges and needs that are unique to unskilled women workers in construction sites.

The socio-psychological challenges and needs refer to the various needs pertaining to women's social and psychological influences engaged in the construction process. Also, research has shown that the socio-psychological challenges and needs of construction workers can be addressed by appropriate motivation. Ogunlana and Chan (1998) reveal that high pay (wages), better accommodation, challenging job, good safety provision, good relationships, and recognition are the workers' motivations from their supervisors on site. Parkin, Tutesigensi and Büyükalp (2009) find that money earned (good wages) is a foremost motivation of construction workers. Regarding unskilled women workers, Rajanna (2015) reveals that they are motivated by higher wages and relatively regularity of employment. Similarly, Dabke (2008) reveals that unskilled women workers can be motivated by increased wages, safety facilities, and supervisor encouragement. However, the studies of Rajanna (2015) and Dabke (2008) are not limited to unskilled women workers who undertake tedious tasks under demeaning conditions on construction sites in developing countries. Therefore, specific insights into motivation for addressing the socio-psychological challenges and needs of unskilled women workers in construction sites are unknown.

This study explores the motivation of unskilled women construction site workers with an emphasis on their social and psychological challenges and needs. The objectives are to identify the challenges of unskilled women workers, assess the specific motivators for unskilled women workers, and assess the factors influencing unskilled women workers' motivation. This study is significant by linking unskilled women workers' motivation to unfavourable site characteristics. Therefore, supervisors on construction sites and construction employers can use the findings of this study to address the challenges facing unskilled women workers in construction sites and meet their needs at the same time. This study has been undertaken in a developing country context, and the findings can be adapted to

other developing countries to motivate unskilled women working on construction sites.

## **LITERATURE REVIEW**

### **Characteristics of construction sites in developing countries**

Construction site practices and procedures did not change for many years, and common mistakes were regularly occurring (Holroyd, 1999). In developing countries, construction sites have been labelled as dangerous or highly hazardous because of the high incidence of accidents and fatalities (Smallwood and Haupt, 2008). In the literature, different factors of poor construction site characteristics have been identified. The first factor is poor site layout and planning. According to Muiruri and Mulinge (2014), this factor refers to bad planning and untidy sites resulting from accidents. The second factor is lacking welfare facilities in construction sites. According to Kolo Daniel (2015), construction workers are denied basic toilet and water facilities because of this factor. The third factor is the poor working environment. According to New York Committee for Occupational Safety and Health (2017), this factor may also be experienced in the form of a toxic working environment where hazardous chemicals are spilt over construction sites. Abdul et al. (2003) state that these chemicals have been found to lead to health problems such as skin diseases and lung poisoning among construction workers. The last factor is the lack of safety awareness procedures in construction sites. This manifests in inappropriate use of protective equipment, lack of knowledge of hazard recognition and prevention and safe work practices (Keng and Rasak, 2014).

### **Theoretical frameworks of motivation**

There are many theories of motivation explaining the nature of motivation at work. These theories are McClelland's Achievement theory, Maslow and Alderfer theory. Others are Goal setting theory, Reinforcement theory, Equity theory, Herzberg's motivation-hygiene theory and Job characteristics theory. The premise of these theories is that humans need to be motivated to carry out work. However, none of the theories is generally acceptably (Langford, 1995).

Furthermore, the theories of motivation mainly expresses the social and psychological needs of humans to work effectively. The McClelland's Achievement Theory reveals the need for achievement, need for affiliation, and need for power as sources of motivation (Mcshane and Glinow, 2000). These needs expresses the social desires of human, for instance, to feel powerful and relevant at work. Also, both the Maslow and Alderfer theories expresses both social and psychological needs for motivation. Maslow considered that humans have five identifiable needs, namely physiological, safety, social, esteem and self-actualization and that these are ordered hierarchically according to whatever need is proponent (Ball, nd). In the Alderfer theory, existence suggests human safety needs, relatedness suggests human belongings needs and growth suggests human esteem and self-actualization needs (Ball,nd). Goal setting theory focuses more on the achievement of goals, and it premise is that people are motivated to successfully attain challenging goals. The achievement of a goal is motivating in itself, however, incentives associated with goals have the effect of encouraging people to work harder. Money encourages commitment to a task, but in itself is not motivating beyond a necessary level of income (Hollyforde and Whiddett 2002). The

reinforcement theory is slightly different by emphasizing on human behaviors. The theory explains that people repeat behaviors followed by favorable consequences and avoid behaviors resulting in unfavorable consequences (Kreitner and Kinicki, 2001). Equity theory is based on fairness. It supposes that a major determinant of job satisfaction and performance of an individual's perception is the relationship between input and output in which input refers to the amount of work put in, while output is the reward from the work. In cases where the two ratios are perceived to be the same, equity is said to exist, and where there is difference, inequity exists, and the person will consider himself as under or over rewarded (Newcombe 1990). The Herzberg's theory is hygiene based (Herzberg, 1959). Hygiene means job environment and if a company fails to provide adequate hygiene factors, the workers are dissatisfied no matter how adequate the salaries and working conditions. Job characteristics theory proposes that there are three psychological states which are experienced meaningfulness of the work, whether the worker feels the job is generally worthwhile. Experienced responsibility for the outcomes of the work – how much the worker feels responsible for the results of their work and Knowledge of the results of the work – the level of knowledge the worker has about their own effectiveness (Hollyforde and Whiddett 2002).

### **Challenges facing women construction site workers**

In the last section, the theoretical framework of motivation has been identified. The studies on the challenges facing unskilled women construction workers in construction sites are reviewed in this section. This review is more indicative than exhaustive, and not all the challenges may have been covered. The first challenge is lack of sanitation and care. Chittibabu (2007) finds that standard toilets are not available for unskilled women workers, and where they are available, they have to share with men construction workers on construction sites. For instance, a recent study by Lekchiri et al (2020) find that women in the construction industry in the USA operate in environments that do not satisfy the basic needs for them to succeed on the job. Also, care facilities like kiddies 'restroom for unskilled women workers with children are not available in construction sites (Baruah, 2010). The second challenge is limited opportunities given to unskilled women construction workers because they are stigmatised as neither reliable nor hardworking (Ojo et al., 2019). The third challenge is reduced wages for unskilled women construction workers in construction sites. Rajanna (2015) reveals that unskilled women workers have been paid ridiculously lesser than men construction workers and lesser than the government's minimum wage. The fourth challenge of unskilled women construction workers is limited opportunities for upskilling in construction tasks on sites. Barnabas, Anbarasu and Clifford (2009) state that such training conditions do not equitably permit women to leave their families (or young families) as their men counterparts. The fifth challenge is belittling remarks which extend to harassments and physical assaults of unskilled women workers on sites (New York Committee for Occupational Safety and Health, 2017). According to Toor et al. (2018), this is almost a culture exacerbated by the "man's world" assumption in the construction industry. Worst still, unskilled women workers, especially the ethnic minority women, perceive themselves negatively and consider themselves at a disadvantage to women of the ethnic majority to secure construction roles (Toor et al., 2018).

### **Factors that influence unskilled women workers motivation**

In the previous sections, the challenging construction site characteristics and the challenges facing unskilled women construction workers on these sites are reviewed. The factors that influence unskilled women construction site workers motivation are reviewed as follows. This can be categorized into financial stability and good supervision. Devi and Golden Rahul (2019) in their study find that unskilled women workers are faced with problem of low wages and other financial benefits that can encourage them to be committed and also to work well. Financial compensation and reward should be provided to help to motivate them. Kumar (2013) and Maneesh and Jasna (2017) in their study pointed out that unskilled women workers are compel with financial problem and the wage structure of the construction labor is found to be inadequate considering the type of rigorous work they do on site. Parkin, A.B; Tutesigensi, A & Buyukalp, A.I (2009), though they were not particular to female but labours in general. They stated that money earn which can be attributed to wages and financial incentives is the foremost motivating factors. Supervision also plays a leading role in influencing unskilled women workers 'motivation. Kazaz et al (2010) in their study finds that good supervision and adequate follow up while working is very vital and helps in motivating construction workers on site. Bacharach, Bauer and Coloney (1989) in their study explained that good supervision helps in improving motivation because workers are treated with respect while on the other hand, bad supervision leads to constantly criticism of workers which then breeds poor job satisfaction.

### **Factors of socio-psychological motivations of unskilled women in construction**

In the previous sections, the factors that influence unskilled women site workers motivation are reviewed. The factors of socio-psychological motivation that encourage unskilled women construction workers are reviewed in this section as follows. Malone et al. (2013)'s study finds five factors of socio-psychological motivation. The first one is having a good working relationship with co-workers, which provides satisfaction on the job. The second one is respect and fair treatment from superiors which also enhances the job satisfaction of unskilled women construction workers and their desire to stick with employers. The third one is a very interesting one, whereby unskilled women construction workers appreciate the rigour (or challenge) of construction tasks. Another study by Regis et al. (2019) supports this finding. The study concludes that although unskilled women working in construction sites face difficulties, they are proud of their work, mainly because it is an honest job, with legal guarantees and courage to participate in the construction work environment. The fourth one is the feeling of accomplishment by unskilled women construction workers while performing such tedious construction tasks. The fifth one is similar and is the feeling valued by employers to enhance women's work satisfaction. A recent study about tradeswomen in the Australian construction industry suggests that women construction workers who experience socio-psychological motivation would not leave their trades career for another job with the same pay and benefits (Lim et al., 2020).

From the accounts in the body of knowledge, it could be seen that construction sites are challenging, especially for unskilled women workers in developing countries who must work under detrimental construction site characteristics. At the same time, the factors of socio-psychological motivation have been identified to encourage unskilled women construction workers. This study will probe into the

specific factors of socio-psychological motivation for encouraging unskilled women workers in construction sites in the developing country of Nigeria.

## RESEARCH METHODOLOGY

This study focuses on the motivation of unskilled women workers who work on construction sites with an emphasis on their social and psychological needs. This study adopts qualitative means of analysis to explore the views of unskilled women workers on the factors of motivation. According to Hamilton (2013), qualitative methods can be employed to draw out complex and deep-lying issues that confront unskilled women in construction. The population of the study is unskilled women construction workers in selected construction sites in Ondo State, Nigeria. The sites were selected because of their nearness to gather raw data and because they had quite many women working on them. Twenty-one construction sites were initially visited, and twelve of them had unskilled women workers working on the projects undergoing construction on these sites. From these sites, nineteen unskilled women workers willing to participate in the research were interviewed. As shown in the table below, the projects undergoing construction in these sites at the time of research are educational, commercial and residential project types. Also, the number of sites with women construction workers are presented.

Project sites	Number of sites with women workers
Educational projects	3
Commercial projects	2
Residential projects	7
Total	12

Table 1: Project and numbers of sites with women

In line with the qualitative methodology, the interview method of data collection was employed. This data collection method is useful to obtain deep and rich data regarding the motivation of unskilled women construction workers, which would not be possible to reach through surveys (Krishnaswami & Satyaprasad, 2010). Specifically, the semi-structured interview was used whereby the unskilled women workers responded to a set of questions, but in the process, they could share additional viewpoints about their responses (Sanders, 2012). The semi-structured interview guide had the background and main questions about the respondents covering age, marital status, level of education, type of project, mode of payment, challenges they face on site, how often they face these challenges, how they respond to these challenges, how do these challenges affect them and their work, their motivators for working on the site, when these motivators should be provided, why they think the motivators are necessary. The procedure for data collection was a face-to-face interview of the respondents by the researcher. Before the start of the interview, each of the respondents was told what the interview was about, that the interview would be recorded, and if some questions seemed unclear, clarification should be sought from the researcher. Each interview lasted about thirty to fifty-five minutes. Also, the interview took three weeks which involved going from site to site. All the interviews were recorded on two different devices to ensure that the recordings remain safe and additional notes were made during

the interview. Afterwards, the interviews were transcribed immediately after the last interview to facilitate the analysis.

The data obtained on the background information of respondents was analysed by frequency. The interpretation of analysed data was made by the highest percentage using the SPSS software. Also, the method of analysis of textual data about the main research questions was thematic analysis. According to Guest et al. (2012), thematic analysis is very useful for capturing the complexities of meaning in a textual data set. Consequently, the thematic analysis process by Guest et al. (2012) was followed as follows. Firstly, the transcripts of the data obtained were reviewed, and important sentences or phrases related to the research objectives were highlighted. Thereafter, all the highlighted sentences were organized under each objective to review their similarities and differences. Secondly, the highlighted and organized data was reviewed again to identify first-order concepts. Afterwards, the first-order concepts were viewed and reviewed again to identify the potential second-order concepts. This led to the second-order themes. Thirdly, following the second-order themes, the aggregate dimensions were formed based on what would simply describe each theme found. In the following section, after presenting the results of the background information of respondents, the results of the thematic analysis of the challenges and factors of motivation of women construction site workers are presented.

## DATA ANALYSIS, PRESENTATION AND DISCUSSION

### Demographic information of respondents

**Table 2: Demographic information of respondents**

Factors	Frequency	Percentage	
Age of Respondents	21-30	4	21.1
	31-40	12	63.2
	41-50	2	10.5
	51-60	1	5.3
	<b>Total</b>	19	100.0
Marital Status	Single	7	36.8
	Married	10	52.6
	Divorced	2	10.5
<b>Total</b>	19	100.0	
Level of Education	Primary school	7	36.8
	Secondary 'O' level	12	63.2
	<b>Total</b>	19	100.0
Working years	1 year	3	15.8
	2-5 years	11	57.9
	6-10 years	5	26.3
	<b>Total</b>	19	100.0
Mode of Payment	Daily	15	78.9
	Weekly	4	21.1
	<b>Total</b>	19	100.0
Mode of Employment	Casual	15	78.9
	Ongoing/permanent	4	21.1
<b>Total</b>	19	100.0	



The results of the analysis of demographic information of respondents are presented in this section. As shown in Table 2, 63.2% (12) of the interviewees are between 31-40 years of age, 10.5% (2) of the respondents are between the ages of 41-50 years, while only one of them is over 50 years of age. In terms of marital status, 52.6% (10) of the respondents are married, 36.8% (7) are single, and 10.5% (2) are divorced. This means there are more married women construction workers in the sites where data was obtained. Regarding the level of education, the findings revealed that most respondents are secondary school graduates (63.2% or 12 number). Those who have only primary school level of education are lesser (36.8% or 7 number). For the years of working experience, 57.9% (11) respondents have been working between 2-5 years in construction sites, 26.3% (5) of them have been working between 6-10 years while 15.8% (3) of them have only been working for less than a year. For the mode of payment, 78.9% (15) of the respondents were paid daily, while 21.1% (4) were paid weekly. For the mode of employment, 78.9% (15) of the interviewees are casual workers, while 21.1% (4) are ongoing or permanent workers in their respective contracting companies.

### **Challenges facing unskilled women construction workers in construction sites**

As mentioned previously, nineteen (19) unskilled women site workers were interviewed to reveal their challenges in construction sites (Objective 1). The results based on the frequency of responses and their ranking are presented in Table 3. Due to overlapping responses, the sum of the frequency of responses is greater than the number of respondents. From the table, nine (9) of the respondents mentioned sexual harassment as the main challenge they encounter in construction sites. The male workers try to misuse the relationship they have with them. With this, their privacies are violated and becomes a serious challenge for them. This challenge is ranked in the first place.

To illustrate, one respondent said....

"ahh, I used to play with everybody, but someone can come to me now and tell me that he or she will slap me and even call me different names that I hate to bear"

Another respondent said:

"the major challenges I have been facing is sexual harassment from the male workers that I work with on site. Male workers that are not even up to my age do come to disturb me with sexual advances"

Unfortunately, these women further pointed that sexual harassment has become a regular occurrence and has made them less bothered by focusing on their works. This could be regarded as a strategy that unskilled women workers employ to prevent them from becoming victims of sexual harassment in construction sites.

Also, in Table 3, six (6) of the women mentioned that they are challenged by work stress due to high workload. This is because these women workers participate in a lot of stressful tasks on site. The stressful tasks include carrying blocks, transporting aggregates and sand, fetching water and even carrying cement daily. The tediousness of these tasks is further exacerbated by the hot weather conditions where unskilled women workers do operate in Nigeria. These tedious tasks affect these women, and some even have to use half of the wages for medical bills. Most

of them suffer from back pain and other musculoskeletal disorders. It is even more difficult for nursing mothers who have to experience stress while taking care of their babies. This can be very disrupting to the flow of work on sites. Also, some of the six respondents mentioned that they had thought about quitting due to work stress. This challenge is ranked in second place.

To illustrate, one of the respondents said.....

“this work is all about stress and though it is something I do every day. To carry head pan, fetch water into drums or even sand fill excavated area is not a joke. Sometimes I get home and I wouldn’t be able to feel every part of my body”

Furthermore, four (4) respondents mentioned unfavourable working conditions such as unprotected sites as the challenge they faced in the construction site. It is a result of poor welfare facilities. This is because of the extended and excessive working hours and exposure to harsh environmental conditions resulting in dehydration and later sickness. Facilities such as toilets, first aid and child care facilities are completely ignored in construction sites. Also, unskilled women workers are exposed to noise, sensitizing and irritant materials, fumes and gases, dust, and other hazardous materials, resulting in adverse health risk. This challenge is ranked in third place.

Lastly, three (3) respondents mentioned constant verbal abuse by male construction workers as their challenge in construction sites. This is because of the supervisor's lack of supervision and the frustration of male workers to lash out at female workers to exercise control. This is done by yelling and screaming different names, lewd comments and abuses. This can be psychologically unhealthy and prevent the women workers from performing satisfactorily. It is ranked in the last place.

**Table 3: Challenges on construction sites**

Challenges	Frequency of women	Rank
Sexual harassment	9	1 <sup>st</sup>
Work stress	6	2 <sup>nd</sup>
Unfavourable working condition	4	3 <sup>rd</sup>
Verbal abuse	3	4 <sup>th</sup>

Equally, the respondents were asked how often they encounter these challenges. Many of them responded that the challenges occur daily at work, and others they encounter occasionally. For instance, the majority of the respondents agree that verbal abuse by male construction workers as a daily occurrence. This is plausible when the women construction workers have conversations with the male ones. The women also mentioned that they shrug off verbal abuses to focus on work and maintain working relationships with their abusers. Also, the majority of the women agree that they encounter sexual harassment occasionally and have been handling this challenge by playing maturity.

To illustrate, one respondent said.....

"... when the male workers come to me with their sexual talks, some will be like they will like to go down with me but I do act mature by playing along with them"

Lastly, the respondents also mentioned that they have been handling the stressful work by using pain-killing drugs.

### **Factors of motivation for unskilled women construction workers in construction sites**

To address the second objective, the respondents were asked to reveal their motivations and the results are presented in Table 4. As shown in the Table, the respondents agreed that the motivations given to them by contractors on construction sites are incentives, good wages, overtime allowances and good supervision. It could be seen that more respondents (11/19) agreed to incentive motivations. This is because the incentives help to encourage, attract and compensate women workers for working harder. It influences the behaviour of workers on construction sites. This also increases the morale of women workers. The incentives motivation is in the form of tips as stated by one of the respondents as follows.....

"...for example, the day I carried three bags of cement the engineer on site had to give me 500naira (about 1\$) as compensation"

However, few respondents (2/19) agree that contractors provide those good wages, overtime allowance and good supervision. Good wages allow workers to make a living from their labour. Good wages make the workers feel valued and also allows them to take care of the family. It helps the women workers to feel motivated. Good wages and overtime allowances make the women workers feel accomplished after each day job and make them work more hours when needed. Overtime allowances serve as extra allowances pay to women workers, which helps motivate them to work beyond normal working hours. Most of the women are happy because it adds to their daily wages, and at least they can settle more bills. Good supervision helps increase women workers confidence on site. It strengthens the relationship between the supervisors and the workers. It also saves them from frustration, confusion, embarrassment and lower productivity.

Regarding good supervision, one respondent said.....

"...the engineer usually appreciate me anytime he come to the site, he used to say that I work like a man and these words makes me try to work more"

Regarding overtime allowance, one respondent said.....

"...sometimes I used to pray that the supervisor should tell us that we are going to work more than the normal time because whenever I don't have much with me that extra money used to fill in voids apart from the daily savings I used to deposit. So time like this I used to work more than normal"

Regarding wages, another respondent said.....

"... I don't know if you know how it feels to be expectant, the expectation that I will collect some amount of money at the end of the day motivates me a lots"

However, from Table 4, most respondents did not agree that contractors provide those good wages, overtime allowance and good supervision (17/19). This is because they see incentives as the major motivational factors. Regardless, the respondents were asked if the identified factors would enhance their motivation in construction sites. Interestingly, nine (9) of the respondents reported that the monetary factors (e.g. incentives, bonuses, good wages) are critical motivations that help them cater to their family, welfare, and motivation to work more on site.

To illustrate, one respondent said.....

".. to help me to work hard on site, it's like my happiness do increase whenever oga (boss) decided to give more small change (money)."

Another respondent said.....

"... why else will I need money if not to take care of my children, personally I work to cater for myself and for my children"

Another respondent said.....

"most times these money makes me look at my engineer as a god sent, because sometimes it is as if he knew what I am passing through by helping me with some money apart from my daily pay"

Additionally, four (4) of the respondents reported non-monetary factor. They state that increasing cordial relationships between them and male construction workers, supervisors, and contractors is a critical motivation factor. This is because it strengthens the bond between them and so helps in understanding one another. To these women, this non-monetary factor alludes to good supervision in construction sites.

**Table 4. Interviewees' motivational factors**

Factors of motivation		Frequency	Percentage
Incentives	Yes	11	57.9
	No	8	42.1
	<b>Total</b>	19	100.0
Bonuses	Yes	2	10.5
	No	17	89.5
	<b>Total</b>	19	100.0
Good wages	Yes	2	10.5
	No	17	89.5
	<b>Total</b>	19	100.0
Good supervision	Yes	4	21.1
	No	15	78.9
	<b>Total</b>	19	100.0

## DISCUSSION OF FINDINGS

This study has assessed the factors of motivation of unskilled women construction workers covering the challenges facing unskilled women workers in construction sites and their motivation factors. The first finding reveals that unskilled women workers encounter sexual harassment as their main challenge in the construction site. Sexual harassment is seen as a common practice by supervisors because of their power and status and financial influences on workers in the construction sites. Devi and Kiran (2013) stated that women workers face sexual harassment and several difficulties in construction sites. Findings of Choudhury (2013) also made us to understand that some women do not get to work regularly or sometimes dropped because they are not yielding to the demand of people attempting to make sexual advances. Research findings by Vettriselvan, Anu, and Rajan (2016) also reported that sexual harassment is a major problem of female workers because they are face with poor security in the construction sites whereby the supervisors and the male colleague abuse the unskilled women workers sexually in the name of payment of wages and giving them jobs.

The study reveals that over-stress due to multiple workload is another challenge that women construction site workers encountered in construction sites. Most works at construction site are tedious, strenuous and sometimes make construction workers tired and aging. This is consistent with the study of Kumar (2018) in India which states that women construction site workers have pain in different part of their body due to the strenuous nature of their work. The physical demand of jobs such as handling of heavy materials, vibration of machine and awkward position causes numerous work-related disorders and diseases like noise-induced hearing, silicosis, muscle strain and sprain and other occupational stress (Abrey and Smallwood, 2014).

Unskilled women workers encounter unfavourable working condition at construction sites. This is due to the extended and excessive working hours and overexposure to harsh environmental condition resulting in dehydration and later sickness. Also, unskilled women workers are exposed to noise, sensitizing and irritant materials, fumes and gases, dusts, and other hazardous materials, resulting in adverse health risk. The above exposes these women and their children to diseases which poses as a treat to their health and safety. Facilities for workers at site are generally poor and workers do not like such and should be provided with uniforms, proper ablution facilities and restroom (Choudhury, 2013 and Datta, 2002).

Women workers complains about contractors, supervisors and coworkers being abusive. This is consistent with findings of Choudhury (2013) in the study of construction workers in Bangladesh, the researcher reported that women are always exposed to verbal assaults at the construction sites. Also, findings of Kumar (2013) in Vijayawada (India) reported that women construction workers women are regularly abused verbally at work as they are financially weaker and have no way to talk back to their supervisors and employers.

The study also assessed the psychological motivation of unskilled women construction site workers and found that incentives serves as the main factor of

motivation in construction sites. For instance, Goal-Setting theory advocates the use of financial incentives to encourage commitment to achieve goals at work. It is also stated that incentives which aid goals have the effect of encouraging people to work harder. This aligns with Ogunlana and Chang (1998) on their study on worker motivation in Bangkok, Thailand. They reported that financial reward is the best way to motivate workers. They claim that workers are paid additional bonuses to increase the workers' income. but it is negates McClelland's achievement theory which cited that people has three sources of needs which are achievement, affiliation and power. These makes people believe more in unambiguous feedback rather than financial incentive.

The finding reveals that good supervision motivates women construction site workers. According to Skinner (1938), reinforcement theory ensures getting desired result and avoiding conflict by either encouraging or discouraging human behavior. This could be either encouraging or attempting to increase a desired behavior or imposing a negative consequences to reduce an undesirable one. This finding aligns with Yisa et al. (2000) and Ogunlana and Chang (1998), though the study focus generally on workers. It explains that positive supervision improves job satisfaction and then job satisfaction motivates workers by boosting their morale, increasing their performances, and strengthening the cordial relationship between workers and supervisors. Barnabas et al. (2009) also reported that

Likewise, overtime allowances and good wages are another factors that motivate construction workers on site. According to Adams (1965) and Pritchard (1969), equity theory shows that workers are rewarded base on the amount of work done. The tedious work that the female construction site workers do on site deserves better reward but this study negates Maneesh and Jasna (2017) and Barnabas et al. (2009) study which reported that women construction workers complained that they are paid less compare to their effort. Khurana (2016) also stated that women workers are not only denied minimum wages, they are also denied their overtime payment even after working beyond their work shift.

## **CONCLUSIONS**

This study has assessed the factors that motivate unskilled women construction workers, the challenges facing unskilled women workers in construction sites and their factors of motivation. Challenges such as sexual harassment, verbal abuse, working under unfavorable weather and high degree of stress poses as difficulty to women workers and sometimes reduce performances. The study also assessed the various factors of motivation such as financial motivators which are incentives, good wages and overtime allowances and also good supervision. These will not only motivate women to work at construction sites but will improve their social and psychological needs of unskilled women construction workers on site. Sexual harassment has the highest frequency among the challenges, followed by work stress due to tedious workload, unfavourable working condition and verbal abuse. Also, incentives have the highest frequency among the factors of motivation then followed by good wages, followed by overtime allowances and good supervision. Therefore, these motivators strengthen the relationship between workers and supervisors and increase the morale of the women workers, meet their immediate expenses, and increase performance.

This study shows that unskilled women construction site workers faced some challenges, and also their major factors motivating construction workers are financial reward and good supervision. Furthermore, the unskilled women workers revealed that these motivators go a long way in helping them. It is on this premise that we recommend that challenges such as sexual harassment, stress and unfavourable working condition should be reduced to the minimum level on site by enacting a law that will protect the unskilled women workers against sexual harassment, provision of basic facilities such as toilet, first aid and child care services and then women should not be forced to work pass the working hour, and also social and psychological needs of workers should be attended to by the contractors to increase their performance which in turn increase productivity on site. This will go a long way by making the women construction site workers happy and will also create a better relationship with the women workers and the contractors or supervisors.

## REFERENCES

- Abdul Hamid, A. R., Wan Yusuf, W. Z., & Singh, B. (2003), Hazards at construction sites. Proceeding of the 5th Asia-Pacific Strutural Engineering and Construction Conference, Johor Bahru.
- Abrey, M., & Smallwood, J. (2014). The effect of unsatisfactory working condition on productivity in the construction industry. Creative construction conference CC 2014 Procedia engineering 85(2014) 3-9
- Adedokun, O. A., Ibironke, O. T., & Olanipekun, A. O. (2013) Vulnerability of Motivation Schemes in Enhancing Site Workers' Productivity for Construction Industry's Sustainability in Nigeria, International Journal of Sustainable Construction Engineering and Technology.
- Adeyemi, A. Y., Ojo, O. O., Aina, & Olanipekun, E. A. (2006). Empirical evidence of Women under-representation in the Construction Industry in Nigeria, Women in Management Review
- Agapiou, A. (2002), Perceptions of gender roles and attitudes toward work among male and female operatives in the Scottish construction industry, Construction Management and Economics
- Aina, O. O. (2014). Application of motivation theories in construction industry. International Journal of business and management. 10(1), 6-9.
- Aiyetan, A. O., & Olotuah, A. O. (2006). Impact of Motivation on Workers' Productivity in the Nigerian Construction Industry, Federal University of Technology, Akure, Nigeria.
- Ajayi, F. A. (2007). Impact of financial incentives on the productivity of construction sites workers in Nigeria. Unpublished dissertation (B.Tech). Nigeria: Federal University of Technology, Akure.
- Alan W. (2004). Getting and analysing of quantitative data. The PREST training resources. Commonwealth of Learning
- Amusan, L. M., Owolabi J. D., Ogunde, A. O., Tunji-Olayeni, P. F., Rapheal R. A., Omuh, I. O., Afolabi, A. O., & Ugochukwu, R. (2017). Vocational skill mobility and its effect on occupational engagement among tradesmen and craftsmen in the building sector. The Turkish Online Journal of Educational Technology, Special Issue for INTE 2017.

- Anin, E. K., Ofori I., & Okyere, S. (2015). Factors affecting job skills of employees in the construction supply chain in the Ashanti region of Ghana. *European Journal of Business and Management*.
- Azhar, S., Miranda, & Griffin, K. (2014) women in construction: success, challenges and opportunities - A USACE case study 50th ASC annual international conference proceedings.
- Baruah, B. (2010) Opportunities and constraints faced by women in construction industry in India; 'Gender and globalization'
- Barnabas, A., Anbarasu, D., & Clifford, P. (2009). A Study on the Empowerment of Women Construction Workers as Masons in Tamil Nadu, India. *Journal of International Women's Studies*.
- Barg, J. E., Ruparathna, R., Mendis, D., & Hewage, K. N. (2014). Motivating Workers in Construction. *Journal of Construction Engineering*. Vol. July, 2014.
- Bee, L. O., Xiaoyun, L., & Benson, T. H. L. (2020). The experiences of tradeswomen in the Australian construction industry, *International Journal of Construction Management*.
- Chitra, N. (2015). A Descriptive Study on Problems of Women Workers in Construction Industry at Tiruchirappalli. *Journal of Humanities And Social Science*.
- Choudhury, T. Experiences of women as workers: a study of construction workers in Bangladesh. *Construction Management and Economics*.
- Dabke, S. S. (2008). Job Satisfaction of Women in Construction Trades, Msc. Thesis, University of Cincinnati, Ohio, United States
- Dainty, A. R. J., Bagilhole, B. M., & Neale, R. H. (2000) A grounded theory of women's career under-achievement in large UK construction companies, *Construction Management and Economics*.
- Datta, R. (2002) Assessing Strategies for Empowerment: Women in Developing Country.
- Devi, K., & Kiran, U. V. (2013) Status of female workers in construction industry in India: a review. *IOSR Journal of Humanities and Social Science (IOSR-JHSS)* Volume 14.
- Doloi, H. (2007) Twinning Motivation, Productivity and Management Strategy in Construction Projects, *Engineering Management Journal*.
- Dube, N. N., Aigbavboa, C. O., & Thwala, W. D. (2015) Challenges facing construction site.
- Fagbenle, O. I. (2009). The effect of non-monetary incentives on the performance of construction craftsmen in Nigeria. In: *Proceedings RICS COBRA Research Conference*. University of Cape Town, South Africa,
- Fagbenle, O. I., Ogunde, A. O., & Owolabi, J. D. (2011). Factors Affecting the Performance of Labour in Nigerian Construction Sites. *Mediterranean Journal of Social Sciences* Vol. 2.
- Fielden, S. L., Davidson, M. J., Gale, A. W., & Davey, C. (2000) Women in construction: the untapped resource, *Construction Management and Economics*.
- Goswami, A., Chaudhury, S., & Garg, T. (2016). Impact of green growth and development path for skilled and unskilled job creation and economic, social sustainability: Case study of India – A recursive. *Economic Modelling, Analysis, and Policy for Sustainability*.
- Giritli, H., & Oraz, T. (2004). Leadership Styles: Some evidence from the Turkish construction industry, *Construction Management and Economics*.



- Gyasi, A. (2012) Assessing roles and contribution of women in the construction industry in Kumasi, Ghana.
- Khurana, S. (2016) Resisting labour control and optimizing social ties: experiences of women construction workers in Delhi: Work; employment and society.
- Kiran (2013) Status of Female Workers in Construction Industry in India: A Review IOSR Journal Of Humanities And Social Science (IOSR-JHSS) Volume 14.
- Keng, T. C., & AbdulRasak, N. (2014) 'case studies on the safety management at construction sites. Journal of sustainability science and management.
- Kolo, D. N. (2015) 'safety issues involving workers on building' Eastern Mediterranean University Gazimagusa North Cyprus.
- Kumar, R. (2013). Gender Discrimination among Construction Workers With Reference To Vijayawada. Vijayawada: Journal of Sociology and Social Work.
- Lekchiri, S., & Kamm, J. D. (2020) Navigating barriers faced by women in leadership positions in the US construction industry: a retrospective on women's continued struggle in a male-dominated industry.
- Lim, B., Bee, L. O., & Feng, S. (2020) Early career women in construction: are their career expectations being met? Construction Economics and Building Vol. 20.
- Luthans, F., & Stajkovic, A. (2000). The Impact of Recognition on Employee Performance.
- Malone, E. K., & Issa R. A. (2013) Work-Life Balance and Organizational Commitment of Women in the U.S. Construction Industry, Journal of Professional Issues in Engineering Education & Practice.
- Maneesh, P., & Jasna P. T. (2017) Socio-economic condition of women construction workers in Kannur district, Kerala. Indian Journal of Economics and Development, Vol 5 (8),
- Meng, X., & Gallagher, B. (2012) The impact of incentive mechanisms on project performance. International Journal of Project Management.
- Muiruri, G., & Mulinge, C. (2004) Health and Safety Management on Construction Projects Sites in Kenya A Case Study of Construction Projects in Nairobi County.
- Mullins, Y. Y. (2005). Global Factors Affecting motivation of Construction Projects. Journal of Construction Research.
- Mutandwa, E., Sigauke, N., & Muganiwa, C. P. (2008). Urban Women's Participation in the Construction Industry: An Analysis of Experiences from Zimbabwe Journal of International Women's Studies.
- Ogunlana, S., Promkuntong, K., & Jearkijrm (1996) 'construction delays in a fast growing economy: comparind Thailand with other economies. International Journal of project management vol 14(2)
- Ogunlana, S. O., & Chang, W. P. (1998) 'Worker motivation on selected construction sites in Bangkok, Thailand', Engineering, Construction and Architectural Management.
- Ofori, G. (2001) Challenges Facing Construction Industries in Southern Africa. Proceedings of Conference on Developing the Construction Industries of Southern Africa, Pretoria, Southern Africa.
- Ofori, G. (2006). Motivating workers in the economy: the case of the Tanzanian construction industry, The International Journal of Human Resource Management.

- Ojo, E. E., Salau O. P., Dirisu J. F., & Waribo, Y. (2019) 'Incentives and job satisfactions, it's implications for competitive positioning and organisational survival in Nigeria manufacturing industries. *American Journal of management*.
- Oso, W. Y., & Onen, D. (2009). *A General Guide to Writing Research Proposal and Report*. Jomo Kenyatta Foundation. Nairobi, Kenya.
- Parkin, A. B., Tutesigensi, A., & Buyukalp, A. I. (2009). Motivation Among Construction Workers in Turkey in Dainty, A.R.J., (ed.). *Proceedings 25th Annual ARCOM Conference*, September, Nottingham, UK.
- Rai, A., & Sarkar, A. (2012). Workplace Culture & Status of Women Construction Labourers; A case study in Kolkata, West Bengal, *Indian Journal of Spatial Science* Tiwari.
- Rajanna, K. A. (2015) Socio economic status of women workers in construction industry: A case study Chikmagalur District of Karnataka. *International Journalism in management and social science (impact factor 3.25) IJMSS vol.03 Issue 03 (March 2015)*
- Rajanna, K. A. (2015), Nature of Work, Working Conditions and Problems of Women Construction Workers: A Case Study, *International journal of business quantitative economics and applied management research*.
- Rose, T., & Manley, K. (2011) 'Motivation toward financial incentive goals on construction projects, *Journal of Business Research*.
- Sandhya, R., & Manjunatha, L. R. (2015) Women workers in construction industry: issues and challenges relating working conditions in Bengaluru, India conference paper
- Smallwood, J., & Haupt, T. (2008). 'Health and safety practice on community projects. The South African experience: proceeding of the 2nd International conference of CIB working commission W99 Honolulu Hawaii pp47-54
- SPSS, Inc. (2003). *SPSS 12.0 for Windows*. [Statistical Analysis Computer Software] Chicago.
- Steers, R. M., Mowday, R. T., & Shapiro, D. L. (2004) 'The future of work motivation theory' *Academy of management review* 29(3)
- Thwala, W. D., & Monese (2012) Motivators of construction workers in the South African construction (a case study) *Journal of economics and behavioural studies*,
- Tor, N. R., Shubashini, S., & Suresh R. Factors Affecting the Equality and Diversity of Ethnic Minority Women in the UK Construction Industry: An Empirical Study
- Vettriselvan, R., Anu, S., & Antony Jesu Rajan, F. S. (2016) Problem faced by women construction workers in Theni District. *International Journal of Management Research and Social Science*.
- Wahab, K. A. (2011) Satisfying the training needs of management and staff in the construction industry. *Proceedings of National Seminar on Effective Contract Management in the Construction Industry*,
- Yisa, S. B., Holt, G. D., & Zakeri, M. (2000) 'Factors affecting management motivation in the Iranian construction industry: a survey of site managers', In *Proceedings of 16th Annual Conference, ARCOM (Association of Researchers in Construction Management)*.
- Zameer, H., Ali, S., Nisar, W., & Amir, M. Impart of the motivation on employee's performance in Beverage Industry of Pakistan *International Journal of Academic Research Accounting, Finance and Management Science*.



# SPATIAL ACCESSIBILITY TO URBAN INFRASTRUCTURE SERVICES AMONG HOTELS IN THE SMALL CITY OF WA, GHANA

Elvis Attakora-Amaniampong<sup>1</sup>, Appau Williams Miller<sup>2</sup> and Emmanuel K. Derbile<sup>3</sup>

<sup>1,2</sup>*SD-Dombo University of Business and Integrated Development Studies. Department of Real Estate and Land Management, Ghana.*

<sup>3</sup>*SD-Dombo University of Business and Integrated Development Studies. Department of Planning and Management, Ghana.*

Though access to urban infrastructure services is a critical factor that facilitates hotel investment, studies have failed to substantiate the accessibility of urban infrastructure services on hotel, most especially in smaller cities. Using the location-based accessibility measure, the study assesses the spatial impact of bus stops, hospital, banks, and shops on hotel accessibility and demand in Wa Municipality. Samples of 33 registered hotels were selected based on their geo-location and variations. The study used the buffer geo-processing model and proximity test to estimate the spatial effect of urban infrastructure services on hotel accessibility and demand. The findings revealed that, there is a weak correlation of urban infrastructure services on hotel investment which triggers low clients turn-out in Wa Municipality. This study contributes to a better understanding of the impact of spatial correlations on hotel investment. However, development planners need to adopt development-based infrastructure provision strategy that captures the impact of UIFs on hotel investment.

Keywords: commercial real estate, hotel investment, infrastructure services, small city, spatial accessibility

## INTRODUCTION

Among the commercial real estate sector, hotel investments have similarly contributed immensely to economic development through domestic employment and revenue generation (Chatzimichael & Liasidou, 2019). Hotel investments are extremely exclusive assets which are typically seen as long-term investments; because of its life span and immovability. Location strategy can have a high negative effect on its investment returns (Dai, Xu, Pratt, & Dai, 2017). In line with these characteristics, hotel investment has since become the focus of geography research in the late 1980s because of its spatial features (Budović, Ratkaj, & Antić, 2018). Many studies have associated accessibility as a conduit to effective location

---

<sup>1</sup> eattak@uds.edu.gh

<sup>2</sup> mappau@uds.edu.gh

<sup>3</sup> ekderbile@uds.edu.gh

strategy (Godinho, Phillips, & Moutinho, 2018; Lado-sestayo & Fernández-castro, 2019, Graf, 2011; Radojevic, Stanistic, Stanic, & Davidson, 2018). Accessibility, plays tremendous role to determine tourist decision, and is one of the most important elements that contributes to hotel performance (Panno, 2019; Li & Du, 2018). Accessibility to hotels breeds higher room demand (Rogerson, 2014), customer preference (Kattara & El-Said, 2013), and huge employment avenue (Bohdanowicz-Godfrey, Zientara, & Bąk, 2019).

Accessibility to urban infrastructure services includes roads, bus stops, shops, hospitals, and banks. Accessibility to these services provide valuable comfort for potential clients (Budović et al., 2018). Theory on hotel accessibility has highlighted that the impact of urban infrastructure services on hotels demand plays critical urban dimensions that needs further studies (Jiang, Gao, Jiang, & Gao, 2019; Lado-sestayo, Vivel-búa, & Otero-gonzález, 2018; Adam, 2013). While studies have tested services such as shops, schools, and train stations in the developed cities especially where hotel investments are high (Budović et al., 2018; Panno, 2019), small cities are underexplored area that requires further studies. Again, most empirical studies used the traveling and walking distance from train station and shops to hotels based on network analysis (Mingzhao Li, Bao, Sellis, Yan, and Zhang, 2018; Kim, Jang, Kang, and James, 2018; and Hilmi and Hadi, 2016). However, the impact of these services on client demand has received little attention in the global south.

The uniqueness of this study is hinged on its choice of study area in many ways. The Municipality is a typical fast-growing one from Sub-Saharan Africa with an emerging and medium-sized city, Wa as its capital (Armed et al., 2020; Dapilah et al., 2019). In a small city like Wa, land use has changed by 34% between the period 1986 and 2018 with changes in urban infrastructure (Armed et al., 2020, Yachori, 2017). Besides, UN-Habitat III empowered such small cities (including Wa) to lead the Sustainable Development Goal trajectories and achievement by 2030 (UN-Habitat, 2016). Again, Wa Municipality as one of the typical West African urban centres, is characterized by the syndrome of development before planning where the locations of urban infrastructure services are not well planned and insufficient (Omar et al, 2020). These dynamics have necessitated for the examination of the effect of urban infrastructure on hotel investment since similar studies are limited in the Global south including Ghana. Following this gap, much interest has motivated current studies in assessing the effects of urban infrastructure services on hotels accessibility even in developed cities (Latinopoulos, 2020). To fill the research gap using a dataset of registered hotels, bus stops, shops, hospitals, and banks, buffer geo-processing model and proximity test of bus stops, shops, banks, hospitals are utilized to determine the traveling time and its effect on hotel demand in the Wa Municipality Ghana. We contribute to literature debate on hotel accessibility analysis in different theoretical and practical ways. First, unlike studies that used walking distances and travelling cost from hotels to shop, this study examined the traveling distance in terms of time and its effects on hotel demand. Secondly, we investigated the effects of distances on hotel demand from the Central Business District to the hotels. The paper is organized into five sections. Section 2 presents a theoretical review of spatial proximity of urban infrastructure service on commercial real estate. Section 3 focuses on the research methodology. Section 4 presented and discussed the results from the buffer-geo processing

model and proximity test analysis. Finally, we concluded the study and discussed some theoretical and practical implications of the study in section 5.

## **LITERATURE REVIEW**

### **Theoretical scope of accessibility**

The concept of accessibility refers to ability to reach or obtain the services and site of a facility at ease which measures the absolute prospect for interaction with a given phenomenon (Lyu, Bertolini, & Pfeffer, 2019). Traditionally, accessibility is embedded in location theory that targets the best use of the productive supply networks at the minimized cost (Nicholls & Nicholls, 2010). Other studies suggest three accessibility measures. These include; infrastructure-based measure which suggests services related to a transport infrastructure that relies on overcrowding stages and average travel speeds using road network (Bohdanowicz-Godfrey et al., 2019; Lado-sestayo et al., 2018; Y. Li & Du, 2018; Yang, Mao, & Tang, 2018). The location-based measures describe the stages of accessibility to spatially distributed urban infrastructure activities (Nicholls & Nicholls, 2010). With this measure, the distance to the facility and its indicators are considered. Lastly, the person-based measures define accessibility at the individual level. Following these approaches, Lyu et al. (2019) contributes to the debate that accessibility is determined considering the availability of easy travelling route, travelling cost and monetary constraints, individual physical conditions, the quality of spatial distribution of urban infrastructure and activities, as well as individual needs. These services have both positive and negative impact on the investor, tourist, and the economy as a whole. According to Lewinson and Esnard (2016), spatial distribution and accessibility of infrastructure services have impact on people especially older adult tourist, given that they are likely to spend majority of their tour at the hotel. Lewinson and Esnard (2016) further indicated that characteristics of the location must facilitate and enhance walkability of pedestrian shopping, street connectivity, public ease of transportation, bus stops and, urban designs. Accessibility studies provide useful suggestion to urban planners for hotel investment (Brans, Engelen, & Hubert, 1981; Cró & Martins, 2017; Taylor & Islam, 2010)

### **Spatial attributes of hotel proximity**

The performance of commercial real estate investments are connected to the spatial attributes of the investments (Korea, Noor, Asmawi, & Abdullah, 2015; Gargallo, Miguel, & Salvador, 2017). Spatial attributes are linked to geographic location, that is longitude and latitude as well multiple quality attributes such as price and rent of the property. Studies have shown that spatial extent of a hotel is retrieved by spatial queries that select hotels based on the location and its relevant distance (Priya & Kalpana, 2018 ; Lu, Lung, & Xie, 2018). Aside that, recent studies have proven that spatial attributes influence market search and how investments differ from different locations (Kolpan & Warren, 2017 ; Zhen, Du, Cao, & Mokhtarian, 2018). Neighbourhood attributes may include the availability of schools, population density, income levels, location, and nearness to central business districts. Studies (eg: Gargallo et al., 2017; Huang, 2018) confirm that prices of hotels tend to be similar because they share common local physical physiognomies such as building size, age, and quality, access to social amenities, employment and shopping centres, which influence investors decision. Similar studies showed that environmental quality, characteristics of the transportation

network and good site for spatial safety influences proximity (Chiarazzo, Coppola, Dell, Ibeas, & Ottomanelli, 2014; Kumar & Bansal, 2016). However, spatial correlation of commercial real estate investments has more complex estimations as demonstrated by Zhang, Du, Geng, Liu, and Huang (2015). Drawing insight from hotel investment for example, the walking distance to a resort centre, site free from flooding, suitable site for on-site wastewater disposal, suitable building sites, access to roads, access to site for deliveries, employees, and guests area determine the spatial extent of the investment (Joeyev, Degloria, Noden, & Locke, 1999; Bovkir & Aydinoglu, 2018). Newell et al. (2006) predict the consequences as high economic burden on the investor as it increases the investors cost and burdened on the client. Meanwhile, these studies have neglected the need to assess the accessibility to shops, hospitals, and banks when defining hotel spatial accessibility.

### **Models of assessing the spatial extent of commercial real estate investments**

Spatial extent of the hotel investment influences investment returns. Mingzhao Li, Bao, Sellis, Yan, and Zhang (2018) determined the spatial extent of a hotel investment by examining the transportation profile of the location of the investments through the nearest geo-locations of the investments with other facilities such as supermarkets and recreational centres using network analysis. They revealed that presence of the facility has two investment impacts. First, client demand increases as the distance from the train stations to the hotel reduces. Second, the presence of the investment influenced shopping activities and the income of the nearest facilities positively. Kim, Jang, Kang, and James (2018) conducted a similar study using autoregressive-first order spatial model including autoregressive errors. Their study found a positive correlation between investments 'location and urban support systems (Kim et al, 2018; Hilmi & Hadi, 2016). Also, Mundell, Taff, Kilgore, and Snyder (2010) used the spatial econometric models to determine the easy accessibility to a hotel. The model used variables such as land use categories in the neighbourhood, time and distance attributes to calculate the relationship between hotel locations and other locational variables. Their model found a strong relationship among them but failed to substantiate on the distance factor (Mundell et al, 2010). Suárez-vega, Santos-peñate, Dorta-gonzález, and Rodríguez-díaz (2011) argues that the use of network analysis as a measure of distance models the problem of resolution, since the minimum cost path sandwiched between every pair of network point is not in a straight line which is usually solved by the ArcGis tools. Also, Multiple regression used by Chiarazzo, Ibeas, and Ottomanelli (2014) shows that there is positive gains when the investment is located within 500 meters buffer from a bus stop and train station. Shen (2005) argues that the mean distance seems to be a more useful measure of the spatial extent of commercial real estate investment since it characterises the aggregated proximity of the investment type to a facility type. His analysis involved the collection of reports of all the mean distances from the investment to the facilities such as schools and hospitals. From their analysis, it was observed that there are lower mean values for accessibility to schools. Chiarazzo et al. (2014) are of the view that though measuring the distance to the facility is important, it necessary to determine the active accessible time such as the travel cost and the shortest time in minutes to the facility. Their results showed that the transport conditions indicated positive signs if the facility were located within 500 meters range from a bus stop and train station, which yielded a higher real return

(Chiarazzo et al., 2014). This finding looks consistent with the findings of North and Miller (2017) where they found that configured coverage maximum travel time and number of facilities closer to the hotel should not be more than 1hr. However, the above finding contradicts with Mimi et al. (2015) idea of distance. According to them determining the distance to commercial facilities does not only ensure significant investment performance but the relationship between land use mixes around the investment. They however, used the sensitivity linear regression model to evaluate number of land use mix within the investment neighbourhood. Their categories include; cultural attractions, number of natural attractions, traffic land area, number of bust stops and number of man-made attractions. Their sensitivity analysis revealed that a buffer of 1000, 2000 and 5000m radii gives a negative relationship of investments such as hotels closer to attractions. However, interestingly, this is contrary to the finding of Ahmad, Elsamen, & Ibrahim (2017). They analysed their data using a circular buffer in the catchment area based on distance to the facility into uniform concentric circles and concluded that the short Euclidian distance to the city and the accessibility of shopping centres suggest a good relation (Ahmad et al., 2017). Surprisingly, our literature review indicates that the previous studies have negeleted the use of hospitals, bus stops, banks, and shops to assess hotel accessibility, which are somehow common UIFs in the emerging cities from the SSA.

## **METHODOLOGY**

The study is mixed research based on spatial, statistical, and qualitative data collection and analysis of hotel and its distances to urban infrastructure services. The study adopted the location-based accessibility measure approach. According to Nicholls and Nicholls (2010), location-based measures describe the stages of accessibility to spatially distributed urban infrastructure. We used this approach because it allows city planners to track accessible urban infrastructure and pursue needed future urban associated platform (Gonzalez-feliu & Grau, 2014). Participant observation was incorporated in the study to identify the effects of externalities such as nature of road network, hotel environment, and service provisions that affect accessibility as suggested by Kim, Jang, Kang, and James (2018) and Hilmi and Hadi (2016).

### **Data sets**

Data for this study involved three sources. The first source involved a registered hotel and their traveling time from Wa CBD data collected from Ghana Tourist Authority, Wa. This data was 33 registered hotels grouped into first grade, second grade, and third grade (budget) categories. The second source involved a collection of ground control points (geo-locations) of each hotel in the Municipality. The final data source was a dataset of registered shops, bus stops, hospitals, and banks, from the Wa Municipal Assembly. The study also sampled 1064 tourists across the hotel grades to determine the impact of traveling time on hotel accessibility (see table 1). We randomly interviewed 20 out of the 33 investors on their perception of hotel investment in the Municipal. Ground control points of Urban Infrastructure Services (UIFS) were collected to ascertain the distance effects on hotels. We used a goggle earth image as a reference point to identify the location of the hotels and a shapefile from the Land Use and Spatial Planning Authority, Wa to support the analysis of the geographic data set.

**Table 1 respondents age and gender**

	Age and Gender of Tourist						Total	Male	Female
	20-30	30-40	40-50	50-60	60-70	70+			
Grade 1	15	27	34	77	33	6	192	112	80
Grade 2	53	66	95	88	12	23	337	197	140
Grade 3	127	109	204	38	28	33	539	405	134
TOTAL	195	468	303	363	73	62	1068	714	354

**Data analysis**

The first analytical approach involved processing of geographic coordinates of the shops, bus stops, hospitals, and banks. Using a map shapefile of Wa Municipality, the coordinates were imported in an ArcView GIS application software and estimated a buffer of 500, 1000, and 1500 meters of hospitals, bus stops, shops and banks to hotels. As a measure of effects, the second step established the relationship in distance between the spatial attributes to the hotels. This was estimated using the proximity test analysis. Empirically, the test has shown a good measure of effects on proximity (Hendrik, Jeuring, & Haartsen, 2016; Jeuring & Diaz-soria, 2017; Yuan et al., 2018). The purpose of this test was to assess hotel accessibility to UIFS. The dependent variables for the test included; Grade 1, Grade 2 and Grade 3 hotels demand. While the independent variables included; the distances from bus stops, banks, shops and hospitals. The analysis used a confidence level of 95%. This enabled to determine the effects between vectors of values among the dependent and independent variables.

Finally, we estimated the traveling distance in terms of time (minutes) to the hotels using Tricycle, which is locally called “Camboo” in the Municipality and it is the commonest transport service operated by individuals with different quoted fares. For hotels within the CBD, we estimated traveling time of 1-5 minnutes. We finally estimated a traveling distance of 4-10 minutes for hotels found at the periphery of Wa. In order to avoid bias in travelling time, we took into accounts the potential CBD congestion in definining the accessibility to hotels in the Manicipality. Figure 1 presents the analytical approach of the study.

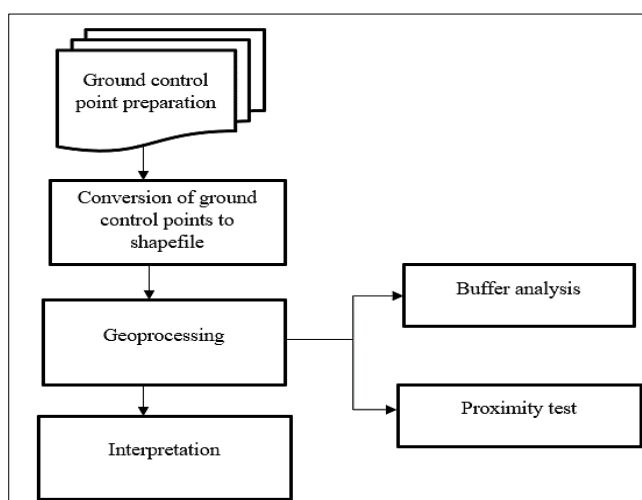

Fig. 1 Analytical procedure of data



## RESULTS AND DISCUSSIONS

### Nature of hotel investments in Wa Municipality

Data gathered from Ghana Tourist Authority showed that hotel investments in Wa have all the three Grades, including the Grade one, two and Grade 3 (Budget) hotels. Statistics from the Authority indicated that, there are 4 Grade one hotels, 7 Grade two hotels, and 22 Budget hotels. This demonstrated that Budget hotels constituted the most dominant hotel investment type in the study area (See table 2). This was supported by assertion by a manager from the Ghana Tourist Authority that:

[...] Even though the city keeps growing, most of the hotel investors still keeps investing in budget hotels, because, the taste of many clients for budget hotels haven't changed" (Management Interview 1, 2020).

Earlier findings showed that when cities grow economic events create competitive advantages for investors, and consumers through economies of scale in commercialization, and infrastructure development (Mimi et al., 2015). Looking at the pace of growth of Wa, hotel clients are not taking advantage of the development to change their taste for other hotel categories. The top management further indicted that;

[...] Over the past 20 years, the cultural, economic and social condition of the Municipality do not encourage hotel investment, because, the municipality is less developed and surrounded by deprived agricultural communities" (Management Interview 4, 2020)

The study revealed that the idea behind the growth was understood to have been the establishment of University for Development Studies, Wa campus (now SDD-UBIDS), the improvement in sports, and businesses. The study further uncovered that even though the urban growth has resulted in investment in other hotel grades, the local people still prefer budget hotels as earlier indicated. This development has given advantage to the development of Grade 1 and 2 hotels to target tourist, businessmen, politicians, NGO's, and researchers. The general impact of the direction of budget hotel business development against the other hotel grades can serve as a good impetus to reform the budget hotel market.

**Table 2 Records of hotel category in Wa Municipality**

Hotel Category	Total Number	Percentage (%)
Grade 1	4	12
Grade 2	7	21
Budget	22	67
TOTAL	33	100

### Spatial extent and its relationship on hotel investments

This section presents the spatial extent and the relationship among hotel investment in Wa. The overlay of ground control points of hotel locations gave the results shown in figure 2. Figure 2 depicts that most budget hotels are spread mostly around the inner city of the Municipality in the neighborhoods of Dobile, Market area, Wapaani, Jengbeyiri, Tindamba and Zongo. The budget hotels dominate over other hotel Grades. Thus, 9 budget hotels out of 22 are in the inner

city of the Municipality. This result further revealed that, these neighborhoods are accessible in terms of distance to hospital, shopping centres, entertainment centres, transport and other inner-city urban services.

Again, it can be observed that budget hotels keep spreading around the outer zones of the Municipality. That is why it is possible to see budget hotels even at the outskirts of the shapefile. Also, most hotels of Grade one and two categories are located in the outskirts of Napagbakoli, Chorkor, Mangu and Konta, Danko Extention, and Sombo. This implies that, as the city grows, hotels with high standards emerged in these new locations outside the city centre. The results also revealed that, 2 hotels out of 5 budget hotels are located outside the captured neighbourhood of the Municipality. Field observation confirmed that, these hotels are located along the high-way of the Wa-Kumasi Road. However, it is knowing to find budget hotels clustering around Grade one and two in the outer zone of the shapefile. This is in line with Mboup and Oyelaran-oyeyinka's (2019) idea that at the municipal level, the emergence of a city is based on the fact that the middle of the city is not recognised as the only centre that grows itself, but, many more several sub-centres collectively develop a networked urban system, with sub-centres performing different functions. However, the pattern of spread of investment products cannot be determined. For example, the locations of budget hotels in figure 2 do not follow any pattern unlike Grade one and two hotels that are mostly located outside the inner-city of the Municipality.

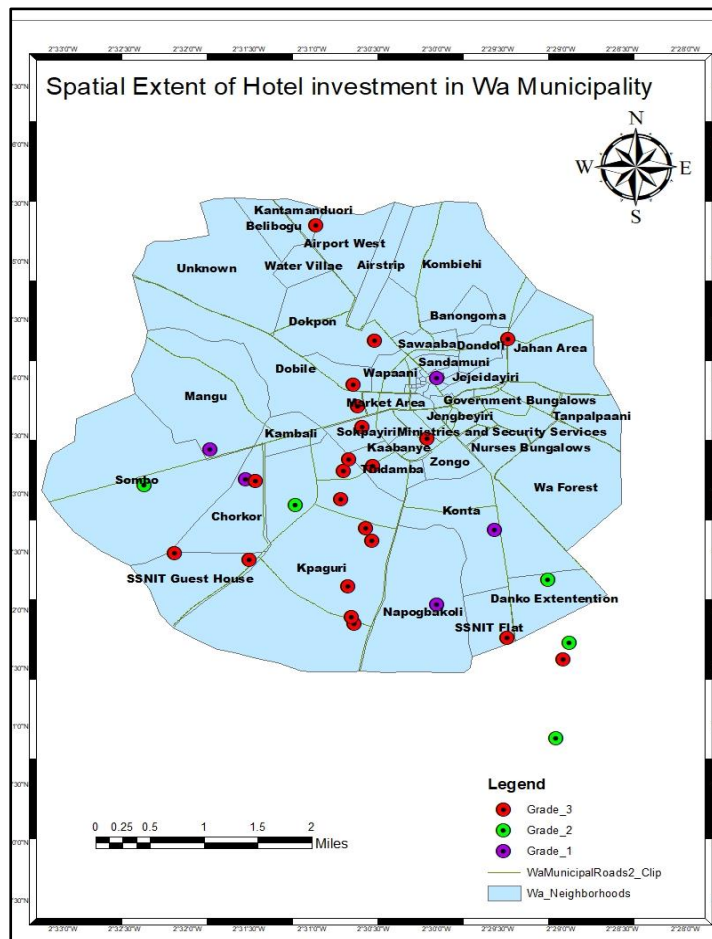

Figure 2 Spatial extent of hotel investment in Wa Municipality

Interview from the office of GTA indicated that:

[...] Even though these budget hotels are the oldest hotels in the neighbourhood, yet, have not undergone massive improvements which commands for high Grade hotels" (Management Interview 7, 2020).

Based on this response the study can infer that; hotel owners do not take advantage of the location of the inner city to improve their hotel Grade. The ripple effect could be that these 'obsolete hotels' would fadeout from the local market and face diversification problems as well. The possible diversification benefit is limited to only residential use, because of their nature and design.

### **Spatial extent of urban infrastructure services and hotel investment**

The urban infrastructure services of this study included hospital, bus stops, shopping centers, banks and roads. The choice of these services was basically their availability. The result of the ground control points of these services are overlaid on the neighborhood map of Wa Municipality is presented by figure 3. This approach supports Zhen, Du, Cao, and Mokhtarian's (2018) idea that the performance of hotel investment is dependent on linkages of urban infrastructure services to the hotel. Figure 3 showed that there are 33 shops, 8 bus stops, 7 financial institutions, and 5 hospitals located around the neighborhoods of hotels. Out of 33 shops, 24 are located around the neighborhoods of budget hotels, 5 around Grade one hotel and 4 at the neighborhood of Grade two hotels respectively. This implies that shop investors target hotel locations that have the highest local demand. However, field observation showed that these shops were not well-structured, yet, attracts the local demand of these hotels. The consequence of these results is argued by Gozgor and Kablamaci (2015) that rates in these hotels in unsuitable location will attract low rate and high vacancy. This literature supports an interview recorded from one investor that:

[...] Here in Wa, the big shops are concentrated in the city centre where clients can buy valuables. The shops around our hotels are run by petty traders and because the neighbourhoods where the hotels are situated are normally outside the city and are not busy, and they don't sell most goods [sic] (Investor 4, 2020).

On the contrary, most hotels around Dobile are obsolete, field observation shown that rates are high with low demand. These results give clear characteristics of an emerging hotel market. The impact factor expressed by investor 8 indicated that:

[...] Providing shops in our hotels offer additional operation and investment cost to us, so we usually prefer client buying from outside shops, ... though this increases the burdening of our clients" [sic] (Investor 8, 2020).

The above is supported by another investor who expressed that:

[...] few hotels that have shops in-built complain of delays in buying products since client turn out are usually low. Because of this client will have to travel to the city centre to buy stuffs" (Investor 12, 2020).

With respect to bus stops, it is evident in figure 3 that 8 bus stops are in the neighbourhoods of these hotels. This finding corresponds to those of Joeyev et al (2018) and Bovkir and Aydinoglu (2018) who found that walking distance to a resort

centre, access to roads, and shopping mall determines UIFs 'spatial correlation with client demand. However, their study did not define what constitute accessibility. For this study, we identified that not all roads are linked to these hotels and as such do not provide extensive benefits of bus stops and shops (see figure 3). This implies that the provision of these services will bring economic burden to the investors which can indirectly be shifted to clients when investors wish to improve on their hotel facility. In this sphere another investor lamented that:

[...] In Wa, most hotels are located around a major road. But access roads linking to Grade 1 and 2 hotels are feeder and deplorable. This affects accessibility of our hostels badly" [sic] (Investor-13, 2020).

The results depict that budget hotel investors are strategic. Thus, they locate their hotels closer to major road network (see figure 3). This result implies that the estimation of accessibility requires a critical understanding of the nature of roads.

Banks on the other hand showed that almost all the financial institutions are located in the inner city of the Municipality, where most budget hotels are located, followed by Grade 1 hotels. Field observation showed that these financial institutions have limited withdrawal stands located in the inner city. The ripple effect could be that clients who want longer stay may demand for hotels in these locations as indicated by Joeyev et al (2018).

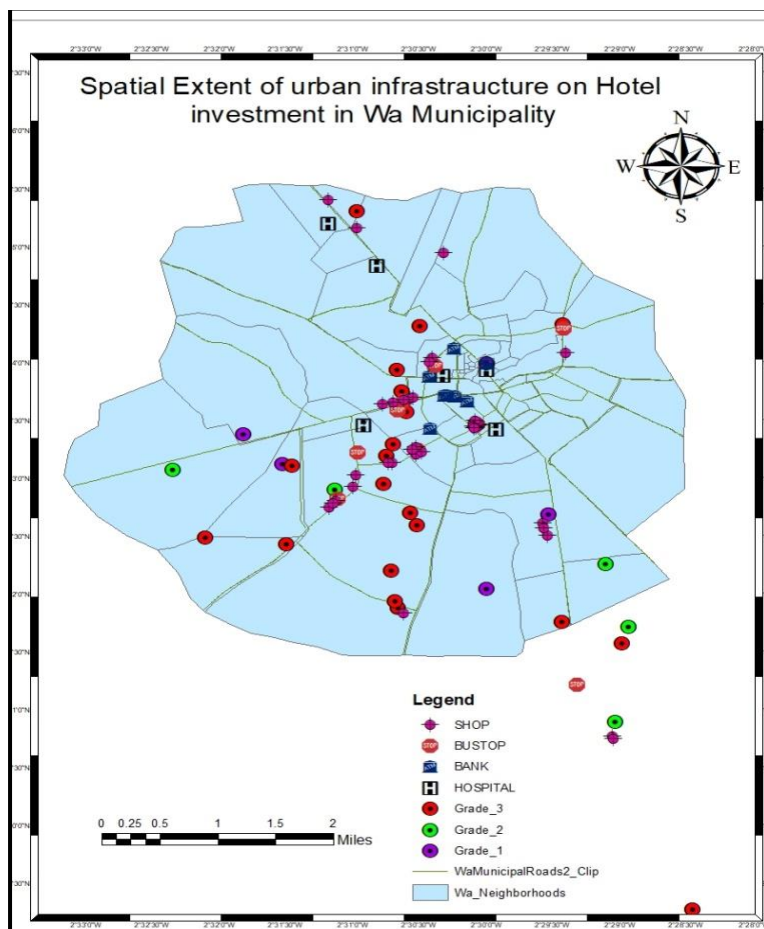

Figure 3 Spatial extent of urban infrastructure services and hotels

### **Urban infrastructure services and hotel accessibility**

Urban infrastructure services have an inherent effect on the functioning of hotel investment. According to Pardo-garcía and Mérida-rodríguez (2018), the residents from periphery of a growing city often struggle moving to central locations closer to the busy areas of the city despite the core opportunity cost of commuting long distance. This seems somehow bias, because, it is not only necessary to determine how accessible these urban infrastructures are to city centre but to hotels. This implies that investments 'accessibility is equally important as social mobility in ensuring urban development. Figure 4 shows the effect of accessibility of bus stops, shops, hospitals, and financial institutions to the hotels.

Figure 4 shows accessibility of hotels to urban infrastructure services in the Wa Municipality. The results showed a buffer of 500, 1000, 1500 meters distance to these services. The results showed that most of the hotels in the Municipality have few shops around them. From figure 4, at a distance of 500 meters, only 14 hotels have easy access to hotels located within the CBD. That is why it is not startling to locate more than one shop around a hotel. This gives an indication that clients of hotels outside the 500 meters accessibility buffer must walk a long distance to access basic services. Again, clients who have no basic information about the neighbourhood (Napagbakoli, Chorkor, Mangu and Konta, Danko Extension, and Sombo) may face challenges accessing shops for their stay. Locals who have basic information about neighbourhoods may demand such hotels at a low pace as indicated and supported by investor respondents. With respect to bus stops, a study by Chiarazzo, Ibeas, and Ottomanelli (2014) showed that there is positive gains when hotels located within a 500 meter range from a bus stop and train station. The results from Wa showed that there are few bus stops in Wa Municipality. Only 8 bus stops were uncovered during field visit. 7 of these bus stops can be accessed within 500 meters and 1 within 1000 metres buffer (see figure 4). This implies that clients would have to walk a long distance to access public transport. Even though some of the bus stops that fall within 500 metres of the hotels have good road network, sometimes these bus stops are located in the opposite direction of the road. Meaning, clients must cross to the opposite direction to access an on-coming vehicle. The positive effect would be easy access to transport but can lead to accident. This can easily be seen in neighbourhood such as Waapane, Kaabanye, Sopkayiri. Based on this we can infer that bus stops can influence positive gains to hotels when their geo-locations are directed towards the hotel. The other aspects can be improved by effective road network to reduce walking distance and time. Results from accessibility to banks showed that most of the hotels are located far beyond the 1500 metre buffer. Only 6 hotels are located around the CBD which have access within 500 metres buffer. The study uncovered that aside the bank, mobile money transfer points are located in some busy neighbourhoods where clients can access. But the distance to these mobile money stands was not determined. Giving these indications, it can be inferred that clients who wish to access hotels must have enough money on them. Because ATM machines are far away from town, not functioning, and queued when functioning.

Figure 4 depicts 5 health facilities in the Municipal. Within a buffer of 500 and 1000 metres most hotels can easily access them. Hotels located in Napagbakoli, Chorkor, Mangu and Konta, Danko Extension, and Sombo must travel about 5 minutes to access these facilities. Field observation indicated that most of these hotels have

no linking road to the high way where clients can access public transport easily in an event to accessing medical care. Following the above, Shen (2005) observed that there are lower mean values for accessibility to hospitals and schools from hotels and it is a true reflection of hotels in the study area. A new development in this hotel market is that accessibility to financial institutions and bus stops is of concern to both investors and clients, because only few hotels have shops. Following the above results, we finally tested the spatial correlation of these services with hotels. Using the hotel grades as dependent variables and distance to shops, banks, hospitals, and bus stops as independent variables, and table 3 depicts the linear sensitivity test results.

Zhou and Clapp (2015) in their estimation used the conditional logit model to examine facility locations, and selections near limited-access highways to determine omitted variables. It was observed that there is high accessibility to the facility if it has a good high way access to the hotel. Their model seems weak because they failed to examine the sensitive of services such as bus stops, banks, hospitals, and shops on hotels. This study further goes beyond to determine the proximity of urban infrastructure services to hotels. From table 3, the analysis showed that Grade one hotels have weak correlation with bus stops and banks accessibility. Budget hotels have weak correlation with banks only, whilst Grade two hotels have weak correlation with hospitals and shopping centres. Generally, all the UIFS have weak correlation in terms of accessibility with the hotels. Therefore, this somehow diffuses literature in the developed cities that the spatial correlation of urban infrastructure in emerging cities had positive impact on hotel accessibility. This cautiously implies that when UIFs are not improved it would affect performance in the long run badly in our case.

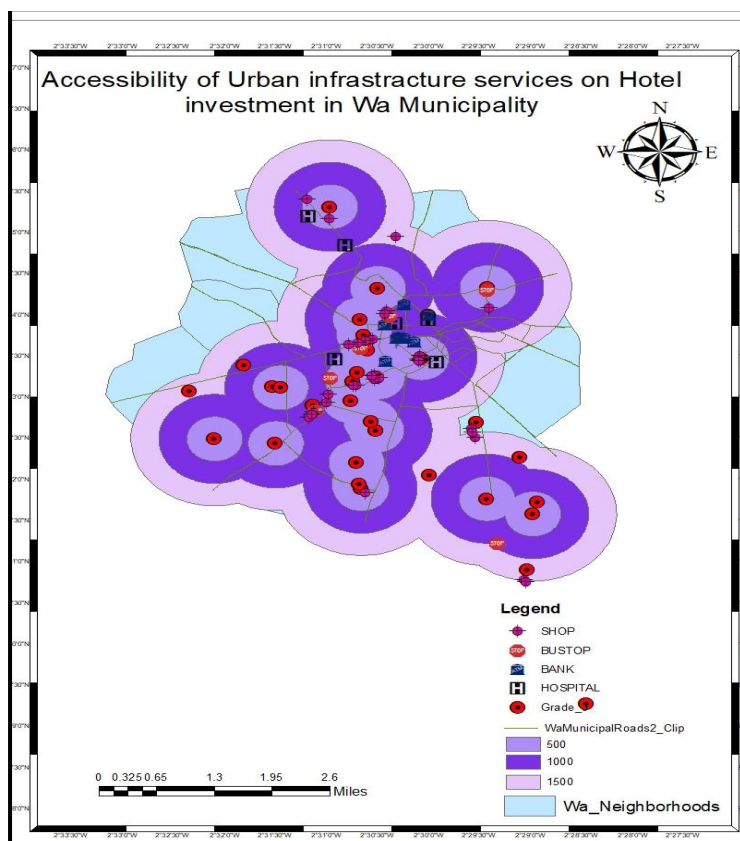

Figure 4 Accessibility of urban infrastructure services among hotel investment in the city of Wa

### Traveling time and its effects on client's demand

The travelling time was estimated using the travelling time of a client using a "Camboo" from the central business district to hotels within the inner city and the peripherals. We estimated the records of hotel demand considering the distance. Figure 5, 6, and 7 give the results of traveling time and its effect on hotel demand.

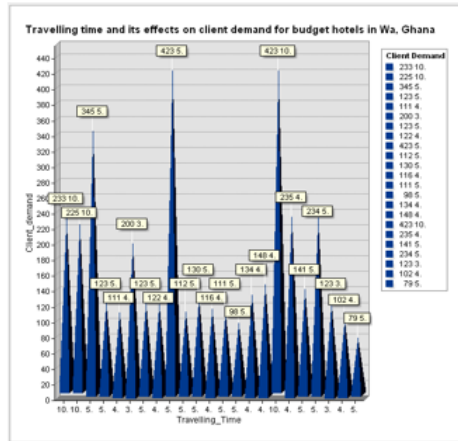

Fig. 5

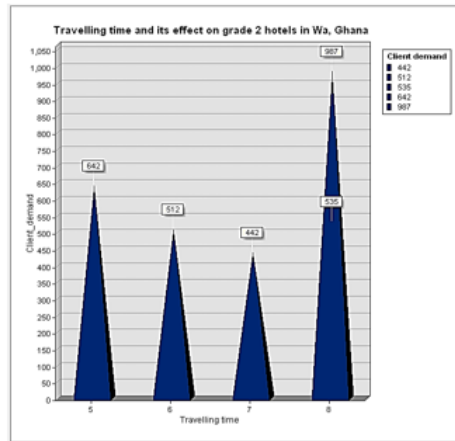

Fig. 6

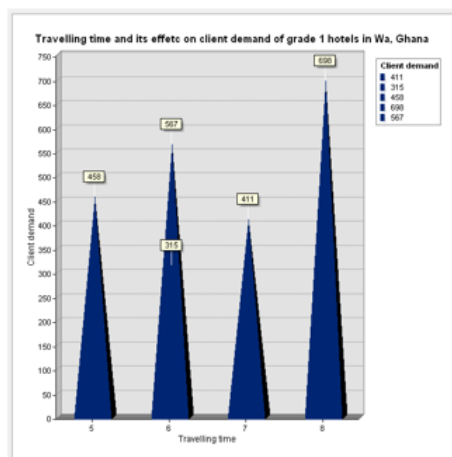

Fig. 7

## CONCLUSIONS AND RECOMMENDATIONS

The study presented the spatial accessibility of hotels to UIFS. The study combined the buffer geo-processing model with Proximity test to measure the distance of shops, bus stops, banks, and hospitals to hotels. This combination provides an additional originality to bear to this study. The findings revealed that hotels have low accessibility to UIFS in the Wa Municipality. Among the hotel category, budget hotels dominate in the Municipality and hospitals, shopping centres, banks, and bus stops are easily accessible in terms of distance in the inner city. The development of the Municipality has also seen a spread in budget hotels in the outer zones of the Municipality and this hotel type followed no pattern, unlike Grade 1 and 2 hotels that are mostly located outside the inner-city of the Municipality. The results further showed that most hotels do not provide basic shopping services especially among the budget hotels. Based on the distance,



clients walk a long way to access shops. Also, hotels located far from the road side normally have no shops around. This implies that shop investors target hotel locations that have the highest local demand. Even though these shops are not well-structured, yet, attract the local demand of hotels. With respect to bus stops, most bus stops that fall within 500 metres of hotels have good road network, and sometimes bus stops are located in the opposite direction of the road. Accessibility to banks showed that most of the hotels are located far beyond the 1500 metre buffer. Only 6 hotels located around the CBD have easy access to banks within 500 metres buffer. It is further realised that aside the banks, mobile money transfer stands are located in some busy neighbourhood where clients can access. The future of hotel investment in Wa Municipality requires that development planners adopt development-based infrastructure provision strategy that captures the impact of UIFs on hotel investment. Thus, urban planners in smaller cities require considering hotel facilities when planning new neighbourhoods for road construction and its ancillary services. All-inclusive collaboration between hotel developers and development planners can provide these services together, especially hotels developing in the peripheries. This will improve hotel accessibility. The Ghana Tourist Authority needs to collaborate with the Land Use and Spatial Planning Authority, Development Planning and the Municipal Assembly to develop an entry guideline for the hotel market. Finally, development planners must educate investors in the need to require planning permission before development.

### **Theoretical and practical implications**

Few geo-information studies on commercial real estate have focused mostly on the impact of UIFS such as bus stops, schools, and land use mix on housing. They focused on accessibility of urban infrastructure to hotels using traveling cost. This study has made a contribution to geo-information studies using other urban infrastructure services such as bus stops, shopping centres, banks, and hospitals in estimating accessibility in small city like Wa. The application of the buffer geo-processing model and proximity test gave a sense of clarity and confidence in estimating the spatial effects of urban infrastructure services on hotels in terms of distance. The study's usage of average traveling time instead of travelling cost was due to lack of data on transport cost. Meaning, the method provides a new approach to examine the effects of urban infrastructure services on hotel accessibility in a smaller city. Further application of interviews and participant observation provided a better understanding of accessibility to hotels. This missing approach in literature added that most bus stops that fall within 500 metres away from the highway have bad road network. However, these bus stops are located in the opposite direction of the road. For this reason, clients must cross to the opposite direction to access an on-coming vehicle. Following this, using travelling cost in estimating easy accessibility to hotels has some flaws in literature.

The study also has some practical implications. The study showed that presence of budget hotels keep spreading around the outer circle of the Municipality, but, poor maintenance culture is common among budget hotels located in the inner-city. This implies that, investors require regular maintenance of hotels if they want to compete effectively in the hotel market. However, the reverse could foresee a future decline in budget hotels which could have diversification disadvantages due to poor maintenance practice. Furthermore, the results showed that most hotels do not provide basic shopping services especially among the budget hotels. Based



on distance, clients walk a long way to access shops. This demonstrates that the establishment of shops in hotels or within a distance less than 100m to hotels will enhance hotel accessibility. Results from accessibility to banks showed that most of the hotels are located far beyond the 1500 metre buffer. This results looked weak as the surrounding land use within 500 and 1000 meters are not purposely for banking services. However, the practical implication that can suffice this is that investors who provide hotel services within 1500 meters are likely to enjoy financial service at ease.

### **Limitations of the Study**

Finally, two limitations were realised from the study. Practically, although the study was able to determine the effects of urban infrastructure services on hotels, the study did not further quantify the effects of these services on hotel performance, considering income and hotel price. Based on that further future study is necessary to quantify the monetary effects of accessibility of urban infrastructure on hotels investments. Also, the use of one medium-sized city study can be a major limitation to this study, however, further studies are highly recommended to include other medium-sized cities to validate the findings of this study.

## **REFERENCES**

- Adam, I. (2013). Urban Hotel Development Patterns in the Kumasi Metropolis, Ghana. *Tourism Planning & Development*, 37–41. <https://doi.org/10.1080/21568316.2012.724706>
- Ahmad, A., Elsamani, A., & Ibrahim, R. (2017). Beyond the random location of shopping malls: A GIS perspective in Amman, Jordan. *Journal of Retailing and Consumer Services*, 34, 30–37. <https://doi.org/10.1016/j.jretconser.2016.09.006>
- Ahmed, A., Korah, P. I., Dongzagla, A., Nunbogu, A. M., Nimminga-Beka, R., Kuusaana, E. D., & Abubakari, Z. (2020). City profile: Wa, Ghana. *Cities*, 97, 102524.
- Bohdanowicz-Godfrey, P., Zientara, P., & Bąk, M. (2019). Towards an accessible hotel: a case study of Scandic. *Current Issues in Tourism*, 22(10), 1133–1137. <https://doi.org/10.1080/13683500.2018.1449191>
- Bovkir, R., & Aydinoglu, A. C. (2018). Providing land value information from geographic data infrastructure by using fuzzy logic analysis approach. *Land Use Policy*, 78, 46–60. <https://doi.org/10.1016/j.landusepol.2018.06.040>
- Brans, J. P., Engelen, G., & Hubert, L. (1981). Accessibility to a Road Network: Definitions and Applications. *Journal of the Operational Research Society*, 32(8), 1–21.
- Budović, A., Ratkaj, I., & Antić, M. (2018). Evolution of urban hotel geography—a case study of Belgrade. *Current Issues in Tourism*, 0(0), 1–16. <https://doi.org/10.1080/13683500.2018.1530200>
- Chatzimichael, K., & Liasidou, S. (2019). A parametric decomposition of hotel-sector productivity growth. *International Journal of Hospitality Management*, 76, 206–215. <https://doi.org/10.1016/j.ijhm.2018.05.010>
- Chiarazzo, V., Coppola, P., Dell, L., Ibeas, A., & Ottomanelli, M. (2014). The Effects of Environmental Quality on Residential Choice Location. *Procedia - Social and Behavioral Sciences*, 162 (Panam), 178–187. <https://doi.org/10.1016/j.sbspro.2014.12.198>

- Chiarazzo, V., Ibeas, Á., & Ottomanelli, M. (2014). Modeling the effects of environmental impacts and accessibility on real estate prices in industrial cities. *ScienceDirect*, 111, 460–469. <https://doi.org/10.1016/j.sbspro.2014.01.079>
- Cró, S., & Martins, A. M. (2017). Hotel and hostel location in Lisbon: looking for their determinants. *Tourism Geographies: An International Journal of Tourism Space, Place and Environment*, 66-88. <https://doi.org/10.1080/14616688.2017.1360386>
- Dai, S., Xu, H., Pratt, S., & Dai, S. (2017). Too Much of a Good Thing ? The Economic Impact of Hotel Investment in Hainan Too Much of a Good Thing ? The Economic Impact of Hotel Investment in Hainan. *Journal of China Tourism Research*, 0(0), 1–20. <https://doi.org/10.1080/19388160.2017.1304862>
- Dapilah, F., Nielsen, J. Ø., & Akongbangre, J. N. (2019). Peri-urban transformation and shared natural resources: the case of shea trees depletion and livelihood in Wa municipality, Northwestern Ghana. *African Geographical Review*, 38(4), 374-389.
- Gargallo, P., Miguel, J. A., & Salvador, M. J. (2017). MCMC Bayesian spatial filtering for hedonic models in real estate markets. *Spatial Statistics. Science Direct*, 22, 47–67. <https://doi.org/10.1016/j.spasta.2017.07.010>
- Godinho, P., Phillips, P., & Moutinho, L. (2018). Hotel location when competitors may react : A game-theoretic gravitational model. *Tourism Management*, 69, 384–396. <https://doi.org/10.1016/j.tourman.2018.06.014>
- Gonzalez-feliu, J., & Grau, J. S. (2014). A location-based accessibility analysis to estimate the suitability of urban consolidation facilities. *International Journal of Urban Sciences*, 37–41. <https://doi.org/10.1080/12265934.2014.930673>
- Gozgor, G., & Kablamaci, B. (2015). What happened to urbanization in the globalization era? An empirical examination for poor emerging countries. *The Annals of Regional Science*, 55(2), 533–553. <https://doi.org/10.1007/s00168-015-0716-7>
- Graf, N. S. (2011). Market structure and demand-side substitutability of chained urban hotel segments. *International Journal of Hospitality Management*, 30(1), 82–90. <https://doi.org/10.1016/j.ijhm.2010.03.011>
- Hendrik, J., Jeuring, G., & Haartsen, T. (2016). The challenge of proximity: the ( un ) attractiveness of near-home tourism destinations. *Tourism Geographies: An International Journal of Tourism Space, Place and Environment*, 66-88. <https://doi.org/10.1080/14616688.2016.1175024>
- Huang, Y. (2018). Environmental risks and opportunities for countries along the Belt and Road: Location choice of China's investment. *Journal of Cleaner Production*. <https://doi.org/10.1016/j.jclepro.2018.11.093>
- Jeuring, J., & Diaz-soria, I. (2017). Introduction : proximity and intraregional aspects of tourism, 66-88. <https://doi.org/10.1080/14616688.2016.1233290>
- Jiang, B., & Yao, X. (2006). Location-based services and GIS in perspective. *Computers, Environment and Urban Systems*, 30, 712–725. <https://doi.org/10.1016/j.compenvurbsys.2006.02.003>
- Jiang, Y., Gao, Y. L., Jiang, Y., & Gao, Y. L. (2019). Factors that Influence Potential Green Hotel Customers 'Decision-making Process – Evidence from China Factors that Influence Potential Green Hotel Customers, 8160. <https://doi.org/10.1080/19388160.2018.1558139>
- Joeyev, A., Degloria, S. D., Noden, M. A., & Locke, P. (1999). Applying Geographic Information Systems. Siting of coastal hotels in Costa Rica. *Costa Rica*.

- Kattara, H. S., & El-Said, O. A. (2013). Customers 'preferences for new technology-based self-services versus human interaction services in hotels. *Tourism and Hospitality Research*, 13(2), 67–82. <https://doi.org/10.1177/1467358413519261>
- Kim, J., Jang, S., Kang, S., & James, S. (2018). Why are hotel room prices different? Exploring spatially varying relationships between room price and hotel attributes. *Journal of Business Research*, 1–12. <https://doi.org/10.1016/j.jbusres.2018.09.006>
- Kolpan, K. E., & Warren, M. (2017). Utilizing Geographic Information Systems (GIS) to analyze geographic and demographic patterns related to forensic case recovery locations in Florida. *Forensic Science International*, 281, 67–74. <https://doi.org/10.1016/j.forsciint.2017.10.014>
- Korea, S., Noor, N. M., Asmawi, M. Z., & Abdullah, A. (2015). Sustainable Urban Regeneration : GIS and Hedonic Pricing Method in determining the value of green space in housing area. *Procedia - Social and Behavioral Sciences*, 170, 669–679. <https://doi.org/10.1016/j.sbspro.2015.01.069>
- Kumar, S., & Bansal, V. K. (2016). A GIS-based methodology for safe site selection of a building in a hilly region. *Frontiers of Architectural Research*, 5(1), 39–51. <https://doi.org/10.1016/j.foar.2016.01.001>
- Lado-sestayo, R., & Fernández-castro, Á. S. (2019). The impact of tourist destination on hotel efficiency: A data envelopment analysis approach, 272, 674–686. <https://doi.org/10.1016/j.ejor.2018.06.043>
- Lado-sestayo, R., Vivel-búa, M., & Otero-gonzález, L. (2018). Connection between hotel location and profitability drivers: an analysis of location-specific effects. *Current Issues in Tourism*, 0(0), 1–18. <https://doi.org/10.1080/13683500.2018.1538203>
- Lewinson, T., & Esnard, A. (2016). Resource Accessibility and Walkability Among Older Adults in Extended-Stay Hotels. *Journal of Housing For the Elderly*, 3893(March). <https://doi.org/10.1080/02763893.2015.1055030>
- Li, Mimi, Fang, L., Huang, X., & Goh, C. (2015). International Journal of Hospitality Management A spatial – temporal analysis of hotels in urban tourism destination. *International Journal of Hospitality Management*, 45, 34–43. <https://doi.org/10.1016/j.ijhm.2014.11.005>
- Li, Mingzhao, Bao, Z., Sellis, T., Yan, S., & Zhang, R. (2018). Journal of Visual Languages and Computing HomeSeeker: A visual analytics system of real estate data. *Journal of Visual Languages and Computing*, 45, 1–16. <https://doi.org/10.1016/j.jvlc.2018.02.001>
- Li, Y., & Du, T. (2018). Assessing the Impact of Location on Hotel Development: An Analysis of Manhattan Hotels, 1822–2012. *Papers in Applied Geography*, 4(1), 21–33. <https://doi.org/10.1080/23754931.2017.1366356>
- Lu, H., Lung, M., & Xie, X. (2018). Querying spatial data by dominators in neighborhood. *Information Systems*, 77, 71–85. <https://doi.org/10.1016/j.is.2018.06.001>
- Lyu, G., Bertolini, L., & Pfeffer, K. (2019). How does transit-oriented development contribute to station area accessibility? A study in Beijing. *International Journal of Sustainable Transportation*, 0(0), 1–11. <https://doi.org/10.1080/15568318.2019.1578841>
- Mboup, G., & Oyelaran-oyeyinka, B. (2019). *Smart Economy in Smart African Cities*. (B. Dahiya, Ed.). Singapore: Springer Nature Singapore Pte Ltd.

- Mundell, J., Taff, S. J., Kilgore, M. A., & Snyder, S. A. (2010). Using real estate records to assess forest land parcelization and development: A Minnesota case study. *Landscape and Urban Planning*, 94, 71–76. <https://doi.org/10.1016/j.landurbplan.2009.08.001>
- Newell, G., Seabrook, R., Newell, G., & Seabrook, R. (2006). Factors influencing hotel investment decision making. *Journal of Property Investment & Finance*, 24(4), 279–294. <https://doi.org/10.1108/14635780610674499>
- Nicholls, S., & Nicholls, S. (2010). Measuring the accessibility and equity of public parks: a case study using GIS. *Managing Leisure*, 6, 201–219.
- North, J., & Miller, F. L. (2017). Facility location using GIS enriched demographic and lifestyle data for a traveling entertainment troupe in Bavaria, Germany. *Decision Support Systems*, 99, 30–36. <https://doi.org/10.1016/j.dss.2017.05.007>
- Panno, A. (2019). Performance measurement and management in small companies of the service sector; evidence from a sample of Italian hotels. Emerald Publishing Limited, <https://doi.org/10.1108/MBE-01-2018-0004>
- Pardo-garcía, S., & Mérida-rodríguez, M. (2018). Physical location factors of metropolitan and rural sprawl: Geostatistical analysis of three Mediterranean areas in Southern Spain. *Cities*, 79(February), 178–186. <https://doi.org/10.1016/j.cities.2018.03.007>
- Priya, M., & Kalpana, R. (2018). Distributed processing of location based spatial query through vantage point transformation. *Future Computing and Informatics Journal*, 1–8. <https://doi.org/10.1016/j.fcij.2018.09.002>
- Radojevic, T., Stanisic, N., Stanic, N., & Davidson, R. (2018). The effects of traveling for business on customer satisfaction with hotel services. *Tourism Management*, 67, 326–341. <https://doi.org/10.1016/j.tourman.2018.02.007>
- Rogerson, J. M. (2014). Changing hotel location patterns in Ekurhuleni, South Africa's industrial workshop. *Urbanistični Inštitut Republike Slovenije*, 25(Special Issue), S81–S95. <https://doi.org/10.5379/urbani-izziv-en-2014-25-supplement-006>
- Shen, G. (2005). Location of manufactured housing and its accessibility to community services: a GIS-assisted spatial analysis. Elsevier Ltd, 39, 25–41. <https://doi.org/10.1016/j.seps.2003.10.008>
- Suárez-vega, R., Santos-peñate, D. R., Dorta-gonzález, P., & Rodríguez-díaz, M. (2011). A multi-criteria GIS based procedure to solve a network competitive location problem. *Applied Geography*, 31(1), 282–291. <https://doi.org/10.1016/j.apgeog.2010.06.002>
- Taylor, P., & Islam, M. S. (2010). Measuring people's space – time accessibility to urban opportunities – an activity-based spatial search algorithm in a GIS. *International Journal of Urban Sustainable*, 37–41. <https://doi.org/10.1080/19463138.2010.513890>
- UN-Habitat, (2016). Urbanization and development: emerging futures. World cities report, 3(4), 4-51.
- Yachori, B. (2017). Urban Planning Capacity Development Response to emerging issues of urbanization in the Wa and Jirapa Township of Upper West Region. University for Development Studies.
- Yang, Y., Mao, Z., & Tang, J. (2018). Understanding Guest Satisfaction with Urban Hotel Location. *Journal of Travel Research*, 57(2), 243–259. <https://doi.org/10.1177/0047287517691153>

- Latinopoulos, D. (2020): Analysing the role of urban hotel location in guests' satisfaction, *Anatolia*, DOI: 10.1080/13032917.2020.1808489
- Zhang, R., Du, Q., Geng, J., Liu, B., & Huang, Y. (2015). An improved spatial error model for the mass appraisal of commercial real estate based on spatial analysis: Shenzhen as a case study. *Habitat International*, 46, 196–205. <https://doi.org/10.1016/j.habitatint.2014.12.001>
- Zhen, F., Du, X., Cao, J., & Mokhtarian, P. L. (2018). The association between spatial attributes and e-shopping in the shopping process for search goods and experience goods: Evidence from Nanjing. *Journal of Transport Geography*, 66, 291–299. <https://doi.org/10.1016/j.jtrangeo.2017.11.007>
- Zhou, T., & Clapp, J. M. (2015). The location of new anchor stores within metropolitan areas. *Regional Science and Urban Economics*, 50, 87–107. <https://doi.org/10.1016/j.regsciurbeco.2014.11.003>



# STRESS-COPING STRATEGIES AMONG CONSTRUCTION PERSONNEL: AN INTEGRATIVE REVIEW

Janet Mayowa Nwaogu<sup>1</sup> and Albert P. C. Chan<sup>2</sup>

<sup>1,2</sup>*Dept. of Building and Real Estate, The Hong Kong Polytechnic University, 11 Yuk Choi Rd., Hung Hom, Kowloon, Hong Kong SAR, China*

Construction personnel are faced with a considerable amount of stress, which negatively impacts their health and well-being. This has spurred research into stress and mental health in the industry. However, studies reviewing stress-coping strategies adopted by construction personnel are lacking. The study integratively reviewed articles on stress-coping strategies among construction personnel to determine the coping strategies employed in the industry and the effect of such strategies on personnel's performance and health. The database of PubMed, Scopus, and Web of Science was searched to retrieve relevant literature within the period 1990 to 2020. Using the PRISMA guidance and CEBM critical appraisal tool, a total of nineteen studies met inclusion criteria. The literature on stress-coping strategies was classified into four categories: family, mental ill-health, workplace stressors, and coping strategy influencers. Project performance increased with the adoption of problem-focused coping and emotion-focused coping behaviors. Cultural values, income, and motivation influenced the type of coping strategy adopted. Problem-focused coping strategies (particularly active coping, social support, religion, and positive reappraisal) alleviated depression, anxiety, and stress. This study informs on appropriate methods and policies for researching stress-coping strategies in the construction industry. There is a need for investigations into resilience as a coping resource, future-oriented stress-coping along the generational gap, and assessment of stress-coping interventions on a "pre and post-intervention" and "short and long time" basis.

Keywords: construction personnel, coping strategies, generational gap, stress, workplace

## INTRODUCTION

Stress is a common factor in the everyday hustle and bustle (Labrague et al., 2018) and specifically related to the construction industry (Love et al., 2010). Such stress has its root in increased work pace resulting from globalization and the role the industry plays in the process (Aitken and Crawford, 2007, Chan et al., 2018). The massive demand for the delivery of infrastructures and structures has made the construction industry home to extreme and counterproductive work stress (Sunindijo and Kamardeen, 2017). Construction professionals and site operatives

<sup>1</sup> janet.nwaogu@connect.polyu.hk

<sup>2</sup> albert.chan@polyu.edu.hk

are subjected to work stressors that negatively impact their health and performance (Bowen et al., 2014, Love et al., 2010, Ojo et al., 2019, Sunindijo and Kamardeen, 2017). Effects of work stress include: (i) mental ill-health (e.g., depression, anxiety, suicidality), (ii) physical ill-health (e.g., headaches, body pains, blood pressure, cardiovascular disease), (iii) low job satisfaction, and (iv) reduced performance (Bowen et al., 2014, Chan et al., 2018, Desjarlais, 1995).

Sources of stress within the construction industry include; time pressures, poor physical work environment, long work hours, work-family/life conflict, low income, organizational culture, job insecurity, interpersonal conflict, little social support from colleagues, bullying, harassment, and gender discrimination (Bowen et al., 2014, Love et al., 2010, Ojo et al., 2019, Sunindijo and Kamardeen, 2017, Leung et al., 2016, Leung et al., 2006). Work stress is a problem for both individuals and organizations (Hannigan et al., 2004). The effect of work stress has been evidenced in the construction industry, as they suffered substantial suicide rates above the general population (Milner et al., 2015, Peterson et al., 2018, Rees-Evans, 2020). In order to withstand the stress and mitigate its adverse impact, construction personnel must engage varying coping strategies. According to Labrague et al. (2017), "coping mechanisms are necessary when dealing with stress and accompanying stressors".

Based on the preceding, this integrative review appraised and synthesized previous studies to deduce stress-coping strategies employed by construction personnel to deal with stress. In order to achieve this aim, the specific objectives are to (i) determine the coping strategies unique to construction professionals and operatives; (ii) determine the effect of coping strategies on performance and the health of construction personnel. This review informs future research and construction organizations on possible coping mechanisms that are more likely to be employed by the two-primary class of construction personnel (professionals and operatives), their health, and performance outcomes. It also informs on research directions which should be target points, thereby giving room for the cross-cultural analysis of coping strategies with the possibility of developing a cross-cultural stress management intervention.

## **LITERATURE REVIEW**

While available evidence (Rees-Evans, 2020, Campbell, 2006) shows that stress and its related outcomes are predominant in the construction industry, reviews on coping strategies, an important construct in the stress and well-being process, are lacking. Although there have been reviews on stress or its outcomes in the industry (Nwaogu et al., 2019, Tijani et al., 2021), none has reviewed coping strategies among construction personnel. Tijani et al. (2021) focused on the classification of stressors and their impact on occupational stress among construction personnel. They recommended the need for considering the role of stressors emanating from the tendering process and the physical work environment on the stress level of workers. Using a scientometric review, Nwaogu et al. (2019) linked mental ill-health to occupational stress in the industry. They emphasized the role of coping strategies as protective factors against the development of mental ill-health.

Burnout, depression, and anxiety have been related to coping strategies (Brenda and Steve, 2006, Haynes and Love, 2004, Langdon and Sawang, 2018). Coping moderates psychosocial factors that an employee is subjected to daily (Brenda and Steve, 2006). Based on the preceding, it is expedient to review how construction personnel in varying economies in the extant literature cope with or manage such stressors and work stress. This will provide information on coping strategies prevalent among construction personnel and the triggers for adopting each strategy. This information would highlight a direction for future research and necessary interventions.

### **Explanation of terms**

Coping strategies refer to the strategies employed to deal with the psychological impact of stress and its health or performance outcome (Folkman et al., 1986). It refers to an individual's conscious effort to withstand, deal with, or overcome a stressful event (Lazarus and Folkman, 1984). According to Folkman et al. (1986), coping strategies serve two primary functions, namely: (i) the regulation of stressful emotions and (ii) alteration of the distress-causing person-environment relationship.

Coping strategies that directly manage a stressor or cluster of stressors are called problem-focused strategies, while those that regulate emotions that arise due to a stressful situation are referred to as emotion-focused strategies (Biggs et al., 2017, Lazarus and Folkman, 1984).

Problem-focused coping is adaptive in nature and behavioral. It involves a person taking positive efforts to assess and solve the stress problem in a logical manner. On the other hand, emotion-focused coping is maladaptive and involves the use of cognitive strategies in trying to reduce psychological distress (Lazarus and Folkman, 1984). Emotion-focused can be described as maladaptive or escapist because the effect is temporary and does not entirely solve the stress. They include denial (Bowen et al., 2014, Langdon and Sawang, 2018). However, the effectiveness of a coping strategy or behavior is determined by fit and context because it depends on how appropriately it corresponds with appraisals and specific conditions (Biggs et al., 2017).

## **METHODS**

### **Design**

The integrative review approach was adopted to examine diverse literature on coping with stress in the construction industry. The review method was considered appropriate due to its ability to allow the inclusion and synthesizing of literature that employed qualitative and quantitative methodologies (Labrague et al., 2018). The review began with a systematic search of existing literature in three databases using keywords. Thereafter, a manual search of specific studies identified from citations and reference lists of previously retrieved articles was conducted using google scholar. To ensure the quality of findings, the PRISMA (Preferred Reporting Items for Systematic Reviews and Meta-Analysis) guidelines were employed to select articles fit to be reviewed.



### Search strategy

The search for literature was conducted in three phases: first, the databases of PubMed, ISI Web of Science (WoS) core collection, and Scopus were visited on March 2021 to retrieve articles for the review. These databases were consulted as they contained the largest concentration of articles in various fields which have undergone rigorous peer review: (i) PubMed for health-related journals (Harris et al., 2014), and (ii) WoS and Scopus for science-related journals (Aghaei Chadegani et al., 2013). Several search strings were combined; those with the best result are "stress" "coping" "construction industry"; "individual resilience," "construction industry," "stress," "personal resources."

Second, to ensure that no critical article was omitted in the retrieval process, the databases of three top science citation indexed journals in the field of construction and engineering were visited to retrieve articles that might be missed out in the first process. The journals are Engineering, Construction and Architectural Management (ECAM), Journal of Construction Engineering and Management (JCEM), and Journal of Management in Engineering (JME). The three construction and engineering-related journals 'database was searched because Naoum et al. (2018) showed the journal outlets accounted for approximately 73% of the total stress-related articles in the construction industry. As regards this research field, the journals satisfy the 80/20 Pareto principle. Figure 1 shows the flow diagram of the process utilized for identifying the relevant literature.

### Inclusion and exclusion criteria

For an article to be eligible for review, the following inclusion criteria were set. The studies had to:

- i. discuss stress-coping strategies among construction personnel (construction professionals or tradesmen).
- ii. not limited to any organization structure within the industry
- iii. be an empirical study and not a preliminary study
- iv. be a journal article
- v. published between the year 1990 and 2020
- vi. be written in the English language

Apart from the failure to meet the inclusion criteria, studies that considered (i) a specific coping construct, (ii) a particular organizational structure were excluded. Measures of depression and anxiety were not considered for exclusion to provide an insight into coping strategies which have been employed by construction personnel in different psychological health conditions. The studies reviewed employed quantitative or qualitative methodologies to elicit stress-coping strategies.

### Search outcome

A total of 222 articles (WoS = 20; PubMed = 7; Scopus = 32; JCEM = 53; JME = 65; ECAM = 45) were retrieved from the initial database search. Duplicates were removed using the endnote reference management software through the "find

duplicates” option. After removing duplicates, a total of 163 articles were subjected to scrutiny using the inclusion criteria. Three additional articles that met inclusion criteria were identified from the citation and reference list of the studied articles. Thereafter, a total of 19 publications were fit for the study (see Figure 1).

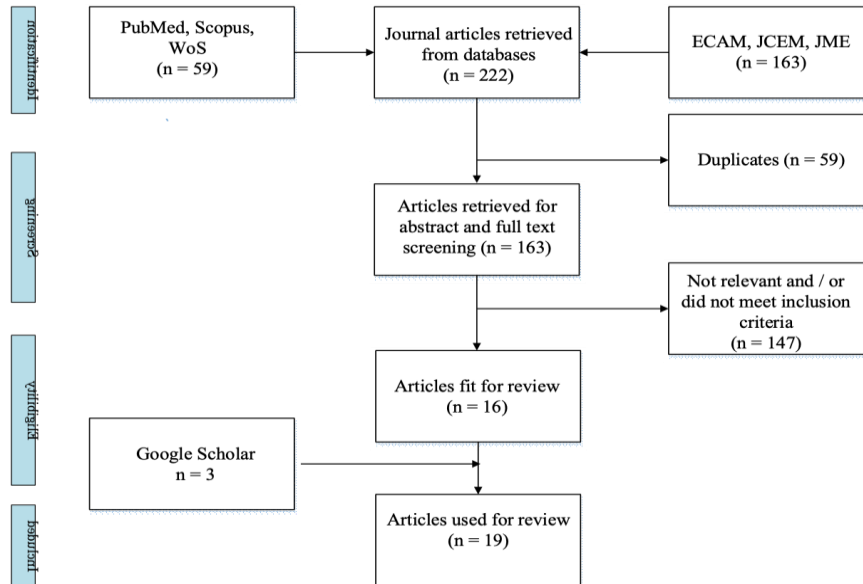

Figure 1. PRISMA Flow diagram for identification of studies used for review.

## RESULTS

The remaining sections of this study outline the result, discussion of the findings, the study limitations, and conclusions. The result section details the study characteristics, research instruments utilized by the studies, and the themes into which the studies on coping can be classified.

### Study characteristics

Nineteen studies were included in the review. Eight of the studies were from Asia: Hong Kong SAR (Leung et al., 2006, Liang et al., 2018, Brenda and Steve, 2006, Chan et al., 2014, Yip et al., 2008), China (Chan et al., 2018, Chan et al., 2012) and Korea (Lim et al., 2017). Four studies from Australia (Haynes and Love, 2004, Langdon and Sawang, 2018, Sunindijo and Kamardeen, 2017, Lingard and Francis, 2008). Three studies were from the United Kingdom (Davidson and Sutherland, 1992, Naoum et al., 2018, Sommerville and Langford, 1994), two studies from Nigeria (Ojo et al., 2019, Oladinrin et al., 2014), and one study each from South Africa (Bowen et al., 2014) and Palestine (Enshassi et al., 2018). All the studies were cross-sectional, out of which the majority (twelve) utilized the quantitative technique, one (1) mixed-method, and six (6) employed qualitative techniques in assessing stress-coping strategies.

### Instruments

Coping strategies adopted by construction personnel to manage stress were measured using quantitative and qualitative methods. Nine (9) of the studies quantitatively elicited information on coping strategies using a psychometric coping construct scale or adapting such coping scales to fit the construction industry context. Two (2) of the nine studies employed Brief Coping Orientation to

Problems Experienced Inventory (BCI). Four (4) studies measured coping methods by using the Ways of Coping Questionnaire (WCQ). Two (2) studies utilized the simplified version of the Ways of Coping Questionnaire (WCQ-R), while other studies derived their coping questionnaire from the WCQ, different coping scales, or previous studies in construction.

Four (4) out of the studies utilized a stress measurement scale, while others developed a questionnaire to elicit such information. The stress scales were used to evaluate stress severity and include Korea Occupational Stress Scale-Short Form (KOSS-SF) (Lim et al., 2017), Depression Anxiety Stress Scale (DASS) (Haynes and Love, 2004, Langdon and Sawang, 2018, Sunindijo and Kamardeen, 2017). In addition to the stress and/or coping scales, some studies utilized other scales to measure mental health symptoms (Haynes and Love, 2004, Langdon and Sawang, 2018, Lim et al., 2017, Sunindijo and Kamardeen, 2017), burnout (Yip et al., 2008), culture value (Chan et al., 2014) and social support (Davidson and Sutherland, 1992).

### **Coping**

The studies employed different terms to describe the coping strategies as varying methodologies and coping psychometric instruments were employed. The articles were analyzed using the thematic analysis approach as described by Braun and Clarke (2006) and Labrague et al. (2018). Following that, four themes were identified from the literature on stress-coping strategies, which formed the basis for grouping the studies:

#### ***(i) Family commitment related coping strategy***

Lingard and Francis (2008) focused on the adaptive coping strategies employed by working couples within the construction profession to withstand work-family imbalance. The adaptive coping strategies employed are the scaling back strategy (i.e., "trading-off" strategy and "job versus career") and work-hour commitment strategy. The work-hour commitment employed include "neo-traditionalist" (40%), "alternative commitment" (34.7%), "dual moderates" (21%), "high commitment" (2.7%), and "crossover commitment" (1.4%). The work-hour commitment differed between gender, as females employed mostly "dual moderates" while the men used the "neo-traditionalist."

#### ***(ii) Coping strategies and mental ill-health symptoms***

Four studies examined the coping strategies employed by construction employees to manage poor mental health symptoms following work stress exposure (Haynes and Love, 2004, Langdon and Sawang, 2018, Lim et al., 2017, Sunindijo and Kamardeen, 2017). The strategies included a range of problem-focused and emotion-focused strategies. For instance, among construction professionals, a higher depression level was related to adopting high levels of avoidance coping, while an active coping strategy reduced depression (Haynes and Love, 2004). Also, Sunindijo and Kamardeen (2017) found that depression and anxiety correlated negatively with active coping, social support, and religious coping behaviors. In contrast, positive reappraisal correlated negatively with depression and anxiety (Sunindijo and Kamardeen, 2017). Lim et al. (2017) reported that construction tradesmen used more active coping strategies (consisting of problem-focused

coping, social support coping styles) than passive coping strategies (emotion-focused coping styles).

Among construction tradesmen, adaptive strategies partially mediate stress (Langdon and Sawang, 2018). The study opined that adaptive strategies seemed unhelpful to the tradesmen, as both adaptive and maladaptive coping strategies had low mean scores. However, maladaptive coping skills (especially self-blame and substance abuse) were used to relieve anxiety by construction tradesmen (Langdon and Sawang, 2018).

### ***(iii) Workplace stressors and coping strategies***

Ten studies evaluated the coping strategies employed to withstand work stress among construction employees (Bowen et al., 2014, Chan et al., 2012, Enshassi et al., 2018, Liang et al., 2018, Naoum et al., 2018, Brenda and Steve, 2006, Davidson and Sutherland, 1992, Sommerville and Langford, 1994, Yip et al., 2008, Leung et al., 2006). For instance, Naoum et al. (2018) found that poor organizational structures were positively related to problem-focused coping behavior (particularly thinking action) and emotion-focused coping (i.e., avoiding action). Likewise, physiological stress had a significant positive correlation with problem-focused coping behavior (alternative thinking), while poor home environment correlated positively with emotion-focused coping behavior (emotional discharge).

Using a qualitative technique, Liang et al. (2018) reported that construction tradesmen adopted mostly emotion-focused coping styles. Such emotion-focused coping includes alcohol consumption, smoking, and expressing negative feelings. Using quantitative techniques, four (4) studies (Brenda and Steve, 2006, Leung et al., 2006, Naoum et al., 2018, Yip et al., 2008) reported that construction professionals tended to use problem-focused coping such as rational problem-solving and direct and control action. Such direct and control actions include "trying different ways in solving a problem," "thinking about the event and learning from the mistake," and "considering several alternatives in handling a problem" (Leung et al., 2006).

Seven studies did not report based on the coping strategy construct, which was mostly employed (Bowen et al., 2014, Chan et al., 2012, Davidson and Sutherland, 1992, Enshassi et al., 2018, Ojo et al., 2019, Oladinrin et al., 2014, Sommerville and Langford, 1994). However, behaviors employed includes ignoring telephone calls, exercise, music, reading books, crying, eating, smoking, sleeping/resting, walking, scolding others, thinking of unrelated things, and attending social functions (Chan et al., 2012, Enshassi et al., 2018, Ojo et al., 2019, Oladinrin et al., 2014).

### ***(iv) Influencers of the choice of coping strategy***

Three studies (Leung et al., 2006; Chan et al., 2014; Chan et al., 2018) found that cultural values and motivation influenced the choice to adopt a particular coping strategy in the face of stress. Chan et al. (2014) indicated that cultural values (particularly interpersonal integration and disciplined work ethos) influenced the choice of coping strategies. For instance, professionals who emphasized interpersonal integration adopted the problem-focused coping strategy, particularly planful problem-solving. Interpersonal integration predicted planful problem solving; disciplined work ethos, positively predicted positive reappraisal, and negatively predicted emotional discharge.

Chan et al. (2018) found that stress expectancy, performance expectancy, and valence of performance were motivations to employing specific coping strategies. An earlier study (Leung et al., 2006) reported that project performance correlated positively with problem-focused coping strategies (i.e., direct and control action, preparatory action), and emotion-focused coping (negative emotional discharge), while a negative correlation existed between project performance and emotion-focused behaviors (e.g., escape coping).

## **DISCUSSION**

This review included 19 articles on stress-coping strategies among construction personnel. It outlines some highlighted effects of stress, the coping strategies employed in the face of stress, factors that influence the type of coping strategy employed, and the impact of coping strategy on performance. Although the studies can be grouped to cover four themes, some gaps were observed. The gap includes the research methodology adopted by the studies. As earlier identified, a number of diverse instruments were employed that may affect the generalization, comparison, and validity of findings. Some effects of stress highlighted by the studies were mental health problems (depression, anxiety), physiological strain, and task performance related (reduced work effectiveness, hasty decision making, poor critical thinking, and mistakes). Other consequences of stress on performance, especially among construction tradesmen, were reduced work quality, reduced work speed, poor interpersonal performance, intention to leave, and increased work accidents (Liang et al., 2018).

### **Coping strategies and mental ill-health symptoms**

The studies showed that both tradesmen and professionals adopted problem-focused coping and emotion-focused coping strategies. However, tradesmen, especially those with lower pay, tend more to adopt emotion-focused strategies (Lim et al., 2017). The utilization of emotion-focused coping behaviors by construction frontline workers could be linked to low job control and inadequate knowledge of effective problem-solving techniques. As regards health, mental ill-health symptoms (particularly depression and anxiety) were found to reduce with the use of problem-focused coping strategies (Sunindijo and Kamardeen, 2017), while the use of substance abuse alleviated anxiety among construction tradesmen (Langdon and Sawang, 2018).

Few of the studies adopted or adapted coping construct scales. The studies that utilized the qualitative methodology analyzed their findings through inductive content or thematic analysis, using previous studies and validated coping questionnaires (WCQ) as a guide. It was difficult to appropriately compare the findings of the studies as they used different constructs to elicit information on coping strategies. The coping assessment tools varied in content and structure. For instance, the acceptance variable in BCI construct reads as "accepting this happened," "learning to live with it" and is classified as an adaptive strategy (problem-focused), while in the WCQ construct, the acceptance variable is a maladaptive strategy. This difference in content and structure hinders for proper comparison of the research findings.

The studies utilized varying themes for some coping constructs. For instance, Leung et al. (2006) had problem-focused coping construct as direct and control action, instrumental support seeking, and preparatory action, while Naoum et al. (2018) had the problem-focused coping construct as control action, thinking action, support seeking, and alternative thinking. The study also found that while some studies (Sommerville and Langford, 1994, Davidson and Sutherland, 1992, Bowen et al., 2014) classified healthy behaviors including exercising and sporting activities as adaptive strategies (or active strategies), some others termed them as maladaptive (avoidance or emotion-focused coping). The use of a unified coping construct scale could enhance better comparison, interpretation, and summary of results. There is a need for research into occupational psychology to develop reliable and validated coping constructs whose wordings are specific to the construction industry context.

Data collection methodology adopted by the majority of the study was of low quality. Studies with high methodology are needed; this will improve the quality of evidence. Presently only a few studies meet high methodology quality. Further studies into stress and coping in the construction industry can benefit from employing mixed-method techniques where the qualitative component should be analyzed using inductive content or thematic analysis. Following that, stress and coping reactions are highly subjective and affected by perception, investigation into stress-coping would benefit from qualitative narratives to better understand how construction personnel handles stress. All the studies reviewed focused on how construction personnel cope with past or present stressors; it is unknown how they will cope with anticipated future stressors. Thus, there is a need for studies to consider future-oriented stress-coping strategies. Such information could improve the quality of coping resources and training in the construction industry.

### **Family commitment related coping strategy**

The study revealed that coping strategies employed among working couples to mitigate work-life/family imbalance were adaptive and differed from those employed individually. There are indications that the highest quality of life is recorded among couples who adopt "dual moderates" and "alternate commitments" work hours strategies than those who engage the "neo-traditional" strategy (Lingard and Francis, 2008, Moen and Yu, 2000). Studying the effect of work hours and family is most appropriate when considering that a couples' ability to cope with stress effectively requires two people (Matthews et al., 2006). More so, in today's world, couples tend to work (Jacobs and Gerson, 2001). Therefore, with the surge in information technology and its influence on work and life, it would be important to study stress-coping strategies employed by married construction professionals, in line with the generation gap and its effect on health and well-being. Such studies would enable drawing conclusions that will inform sustainable job design, job satisfaction, and improved physical, mental health and well-being.

### **Choice of coping strategies**

This study deduced that a few factors influenced construction professionals' choice for a specific coping strategy. These factors (cultural values and motivation) acted in the capacity of an antecedent and a facilitator. The cultural values are interpersonal integration and disciplined work ethos. Interpersonal integration such as trustworthiness, patience, sincerity influenced the adoption of the

problem-focused coping strategy, particularly planful problem-solving (Leung et al., 2010). In comparison, disciplined work ethos such as persistence, prudence, knowledge, and resistance to corruption prevented the use of emotion-focused coping (especially emotional discharge) and enhanced the use of a problem-focused coping strategy (Chan et al., 2014, Leung et al., 2010).

The motivation to adopt a particular coping strategy (or strategies) in the face of stress was related to stress expectancy, performance expectancy, and valence of performance. According to Chan et al. (2018), the motivations are stress expectancy (effective stress reduction, increasing problem-solving abilities, maintain a clear mind), performance expectancy (increase task performance), and valence of performance. The study noted that the choice of coping strategy imparted on performance outcomes. The categories of performance were task performance (project performance, poor process performance), interpersonal performance (good cooperation, negative interpersonal relationship), and organization performance (poor organization relationship).

Project performance increased due to the adoption of "direct and control action" problem-focused strategy, and "negative emotional discharge" emotion-focused coping strategy (such as smoking, taking more tranquilizers) (Leung et al., 2006). Also, the use of "instrumental support" such as seeking support from colleagues improved project performance." On the other hand, escape coping behavior negatively affected project performance. This implies that the kind of performance which a construction employee desires to see motivates them to adopt specific coping strategies.

Presently, there are few studies into copings strategies that considered the effect of personal resources, particularly self-efficacy, self-esteem, or resilience, on the choice of coping strategies adopted by construction personnel. There is a need for stress-coping studies among construction personnel to consider these personal resources construct, their influence on coping strategies, and related impact on health, well-being, and performance. This would inform on personal resources and coping interventions required for each category of construction personnel.

## **LIMITATION OF THE STUDY**

The results are heterogeneous with different names for coping construct measures due to the use of different scales or the adaptation of coping construct questions from several authors. The exclusion criteria were relaxed to allow for reviewing more studies into coping strategies adopted by the construction workforce. Despite the number of articles, the study contributes to the body of knowledge by calling on research with quality methodologies.

## **CONCLUSIONS**

This study reviewed stress-coping strategies among construction personnel. It showed that stress influenced health, well-being, and performance. It was deduced that both problem-focused and emotion-focused coping strategies are adopted by construction professionals, while construction frontline workers tend more to adopt emotion-focused coping behaviors. There is a need for training construction

personnel on coping strategies and the adoption of effective coping strategies. The study indicates that researches on coping strategies should link specific strategies to stressors among construction personnel. The link could highlight better points and measures for primary and secondary job stress interventions. This review recommends that further studies should employ mixed methods. The findings from studies that adopt such mixed methods will better inform on appropriate stress-coping interventions for the construction industry. In the case of a purely quantitative study, the use of WCQ or its simplified version might yield a better result in the industry. There is a need for research in occupational psychology to develop reliable and validated coping constructs whose wordings are specific to the construction industry context.

The study recommends extensive studies on coping strategies among construction personnel in other countries to enhance developing interventions necessary for appropriate job stress management and education on healthy and adaptive coping measures. Studies into the effect of coping strategies on physical and mental health and the role of personal resources (e.g., resilience, self-esteem) as a coping resource are needed. Further studies should consider future-oriented stress-coping strategies; the studies can also be done from a generation gap perspective. Intervention studies on the effect of coping strategies at pre and post-intervention stages are required in the construction industry; this will improve the quality of evidence and better inform interventions needed for effective stress management.

## REFERENCES

- Aghaei Chadegani, A., Salehi, H., Yunus, M., Farhadi, H., Fooladi, M., Farhadi, M. & Ale Ebrahim, N. (2013). A comparison between two main academic literature collections: Web of Science and Scopus databases. *Asian social science*, 9, 18-26.
- Aitken, A., & Crawford, L. (2007). Coping with stress: Dispositional coping strategies of project managers. *International Journal of Project Management*, 25, 666-673. <https://doi.org/10.1016/j.ijproman.2007.02.003>.
- Biggs, A., Brough, P. & Drummond, S. (2017). Lazarus and Folkman's psychological stress and coping theory. *The handbook of stress and health*, 349-364.
- Bowen, P., Edwards, P., Lingard, H., & Cattell, K. (2014). Workplace stress, stress effects, and coping mechanisms in the construction industry. *Journal of Construction Engineering and Management*, 140, 04013059. [https://doi.org/10.1061/\(ASCE\)CO.1943-7862.0000807](https://doi.org/10.1061/(ASCE)CO.1943-7862.0000807).
- Braun, V., & Clarke, V. (2006). Using thematic analysis in psychology. *Qualitative research in psychology*, 3, 77-101.
- Brenda, Y., & Steve, R. (2006). Coping strategies among construction professionals: Cognitive and behavioural efforts to manage job stressors. *Journal for education in the Built Environment*, 1, 70-79.
- Campbell, F. (2006). *Occupational stress in the construction industry*. Berkshire, UK: Chartered Institute of Building.
- Chan, I., Leung, M. Y., & Liang, Q. (2018). The roles of motivation and coping behaviours in managing stress: Qualitative interview study of Hong Kong expatriate construction professionals in mainland China. *International journal of environmental research and public health*, 15, 561.



- Chan, I. Y. S., Leung, M. Y., & Yu, S. S. W. (2012). Managing the stress of Hong Kong expatriate construction professionals in Mainland China: Focus group study exploring individual coping strategies and organizational support. *Journal of Construction Engineering and Management*, 138, 1150-1160.
- Chan, Y. S. I., Leung, M. Y., & Yuan, T. (2014). Structural relationships between cultural values and coping behaviors of professionals in the stressful construction industry. *Engineering, Construction and Architectural Management*, 21, 133-151. 10.1108/ECAM-07-2012-0069.
- Davidson, M. J., & Sutherland, V. J. (1992). Stress and Construction Site Managers: Issues for Europe 1992. *Employee Relations*, 14, 25-38. 10.1108/01425459210012680.
- Desjarlais, R. (1995). *World mental health: Problems and priorities in low-income countries*, Oxford University Press, USA.
- Enshassi, A., Al-Swaity, E., Abdul Aziz Abdul, R., & Choudhry, R. (2018). Coping behaviors to deal with stress and stressor consequences among construction professionals: A case study at the Gaza Strip, Palestine. *Journal of Financial Management of Property and Construction*, 23, 40-56. 10.1108/JFMPC-12-2016-0057.
- Folkman, S., Lazarus, R. S., Dunkel-Schetter, C., DeLongis, A., & Gruen, R. J. (1986). Dynamics of a stressful encounter: cognitive appraisal, coping, and encounter outcomes. *Journal of personality and social psychology*, 50, 992.
- Hannigan, B., Edwards, D. & Burnard, P. (2004). Stress and stress management in clinical psychology: Findings from a systematic review. *Journal of Mental Health*, 13, 235-245. 10.1080/09638230410001700871.
- Harris, J. D., Quatman, C. E., Manring, M., Siston, R. A. & Flanigan, D. C. (2014). How to write a systematic review. *The American journal of sports medicine*, 42, 2761-2768.
- Haynes, N. S. & Love, P. E. (2004). Psychological adjustment and coping among construction project managers. *Construction Management and Economics*, 22, 129-140.
- Jacobs, J. A. & Gerson, K. (2001). Overworked individuals or overworked families? Explaining trends in work, leisure, and family time. *Work and occupations*, 28, 40-63.
- Labrague, L. J., Mcenroe-Petitte, D. M., Gloe, D., Thomas, L., Papathanasiou, I. V. & Tsaras, K. (2017). A literature review on stress and coping strategies in nursing students. *Journal of Mental Health*, 26, 471-480.
- Labrague, L. J., Mcenroe-Petitte, D. M., Leocadio, M. C., Van Bogaert, P. & Cummings, G. G. (2018). Stress and ways of coping among nurse managers: An integrative review. *Journal of clinical nursing*, 27, 1346-1359.
- Langdon, R., & Sawang, S. (2018). Construction Workers 'Well-Being: What Leads to Depression, Anxiety, and Stress? *Journal of Construction Engineering and Management*, 144, 04017100. 10.1061/(ASCE)CO.1943-7862.0001406.
- Lazarus, R. S., & Folkman, S. (1984). *Stress, appraisal, and coping*, Springer publishing company.
- Leung, M. Y., Chan, Y. S., & Yuen, K. W. (2010). Impacts of stressors and stress on the injury incidents of construction workers in Hong Kong. *Journal of Construction Engineering and Management*, 136, 1093-1103.
- Leung, M. Y., Liang, Q. & Olomolaiye, P. (2016). Impact of Job Stressors and Stress on the Safety Behavior and Accidents of Construction Workers. *Journal of Management in Engineering*, 32, 04015019. [https://doi.org/10.1061/\(ASCE\)ME.1943-5479.0000373](https://doi.org/10.1061/(ASCE)ME.1943-5479.0000373).

- Leung, M. Y., Liu, A. M., & Wong, M. M. K. (2006). Impact of stress-coping behaviour on estimation performance. *Construction Management and Economics*, 24, 55-67.
- Liang, Q., Leung, M. Y., & Cooper, C. (2018). Focus group study to explore critical factors for managing stress of construction workers. *Journal of Construction Engineering and Management*, 144, 04018023.
- Lim, S., Chi, S., Lee, J. D., Lee, H. J., & Choi, H. (2017). Analyzing psychological conditions of field-workers in the construction industry. *International journal of occupational and environmental health*, 23, 261-281.
- Lingard, H., & Francis, V. (2008). An exploration of the adaptive strategies of working families in the Australian construction industry. *Engineering, Construction and Architectural Management*, 15, 562-579. 10.1108/09699980810916997.
- Love, P. E. D., Edwards, D. J., & Irani, Z. (2010). Work Stress, Support, and Mental Health in Construction. *Journal of Construction Engineering and Management*, 136, 650-658. 10.1061/(ASCE)CO.1943-7862.0000165.
- Matthews, R. A., Del Priore, R. E., Acitelli, L. K., & Barnes-Farrell, J. L. (2006). Work-to-relationship conflict: Crossover effects in dual-earner couples. *Journal of Occupational Health Psychology*, 11, 228.
- Milner, A., Witt, K., Burnside, L., Wilson, C. & Lamontagne, A. D. (2015). Contact & connect—an intervention to reduce depression stigma and symptoms in construction workers: protocol for a randomised controlled trial. *BMC public health*, 15, 1062.
- Moen, P. & Yu, Y. (2000). Effective work/life strategies: Working couples, work conditions, gender, and life quality. *Social problems*, 47, 291-326.
- Naoum, S. G., Herrero, C., Egbu, C. & Fong, D. 2018. Integrated model for the stressors, stress, stress-coping behaviour of construction project managers in the UK. *International Journal of Managing Projects in Business*, 11, 761-782.
- Nwaogu, J. M., Chan, A. P. C., Hon, C. K. H. & Darko, A. (2019). Review of global mental health research in the construction industry: A science mapping approach. *Engineering, Construction and Architectural Management*, 27, 385-410. <https://doi.org/10.1108/ECAM-02-2019-0114>.
- Ojo, G. K., Adeyeye, G. M., Opawole, A. & Kajimo-Shakantu, K. (2019). Gender differences in workplace stress response strategies of quantity surveyors in Southwestern Nigeria. *International Journal of Building Pathology and Adaptation*, 37, 718-732. <https://doi.org/10.1108/IJBPA-10-2018-0084>.
- Oladinrin, T., Adeniyi, O., & Udi, M. (2014). Analysis of stress management among professionals in the Nigerian construction industry. *International Journal of Multidisciplinary and Current Research*, 2, 22-33.
- Peterson, C., Stone, D. M., Marsh, S. M., Schumacher, P. K., Tiesman, H. M., Mcintosh, W. L., Lokey, C. N., Trudeau, A.-R. T., Bartholow, B., & Luo, F. (2018). Suicide rates by major occupational group—17 states, 2012 and 2015. *Morbidity and Mortality Weekly Report*, 67, 1253.
- Rees-Evans, D. (2020). *Understanding Mental Health in the Built Environment*. Bracknell, UK: Chartered Institute of Building.
- Sommerville, J., & Langford, V. (1994). Multivariate influences on the people side of projects: stress and conflict. *International Journal of Project Management*, 12, 234-243.

- Sunindijo, R. Y., & Kamardeen, I. (2017). Work Stress Is a Threat to Gender Diversity in the Construction Industry. *Journal of Construction Engineering and Management*, 143, 04017073. [https://doi.org/10.1061/\(ASCE\)CO.1943-7862.0001387](https://doi.org/10.1061/(ASCE)CO.1943-7862.0001387).
- Tijani, B., Jin, X., & Osei-Kyei, R. (2021). A systematic review of mental stressors in the construction industry. *International Journal of Building Pathology and Adaptation*, 39, 433-460. 10.1108/IJBPA-02-2020-0011.
- Yip, B., Rowlinson, S., & Siu, O. L. (2008). Coping strategies as moderators in the relationship between role overload and burnout. *Construction Management and Economics*, 26, 871-882.



## STUDENTS' PERCEPTIONS ABOUT TRAINING ON PROPERTY VALUATION TECHNIQUES IN SELECTED TERTIARY INSTITUTIONS IN NIGERIA

Augustina Chiwuzie<sup>1</sup>, Daniel Ibrahim Dabara<sup>2</sup>, Edith Mbagwu Prince<sup>3</sup>, Sayo Tolani Olawuyi<sup>4</sup> and Sayo Tolani Olawuyi<sup>5</sup>

<sup>1,3,4,5</sup>*Department of Estate Management, The Federal Polytechnic Ede, Nigeria*

<sup>2</sup>*Department of Estate Management, University of Ibadan, Nigeria*

Techniques employed in property investment valuation have continued to serve as an endless discussion topic among academics and professionals in the real estate. Throughout the discussion, a common thread is a need for property valuers to be adequately trained on critical valuation techniques, which is necessary for ensuring that property investment valuations are reliable and compare with other investment mediums in the investment market. Over the years, real estate students' training on valuation methodologies has followed two distinct techniques, namely, conventional and contemporary valuation techniques. This study assesses students' perception of property valuation techniques in selected tertiary institutions in Nigeria to identify gaps in knowledge. The study's data was collected through a survey of all graduating real estate students from two universities and two polytechnics in South-west, Nigeria. A total of 114 students across the identified institutions was selected using purposive sampling. Descriptive statistics were utilised in analysing the data obtained. Analyses are presented for the students' level of awareness and understanding of conventional and contemporary property valuation techniques. The results show that awareness and understanding levels are higher for conventional valuation techniques with group mean scores of 3.96 and 3.80, respectively. Further analysis on students' views on the teaching and learning of property valuation techniques was conducted. The respondents strongly agreed that practical-based training would promote a better understanding of property valuation techniques. The study concludes that a practical-based property valuation curriculum in the Nigerian tertiary institutions is necessary to equip graduates with the requisite knowledge that aligns with the needs of the property investment market.

Keywords: conventional and contemporary valuation methods,, learning and teaching, polytechnic, real estate investment, university

---

<sup>1</sup> okaugusta@yahoo.com

<sup>2</sup> danieldabara44@gmail.com

<sup>3</sup> edithmbagwu@gmail.com

<sup>4</sup> pade202@yahoo.com

<sup>5</sup> tolanicar@gmail.com

## INTRODUCTION

Property valuation is the crux of the real estate career and thus demands all the focus required to be in line with the current economic realities. Property valuation is an objective estimation by knowledgeable practitioners of the most probable sale price of land and buildings. In Nigeria, property valuation is exclusively reserved for persons properly registered under the Estate Surveyors and Valuers (Registration, etc.) Act No. 24 of 1975, now Cap E13 Laws of the Federation of Nigeria 2007, as estate surveyors and valuers. Therefore, property valuation remains one of the primary functions of estate surveyors and valuers (Ifediora, 2005). The estate surveyors and valuers employ established valuation techniques to give an expression of the value of a property, after thorough investigation of a number of variables. One important criterion for evaluating the value of a property is the comprehension and application of suitable techniques for a particular valuation assignment (Oloke et al., 2017).

Techniques employed in property investment valuation have continued to serve as an endless subject of debate among real estate academics and professionals. A common theme in the debate is the need for property valuers to be properly trained in vital valuation techniques to meet the changing needs of investors caused by changes in the economic environment. Valuers' training in Nigeria begins with the acquisition of academic qualifications including the Senior Secondary School Certificate of Examination (SSCE), National Diploma (ND), Higher National Diploma (HND), Bachelor and Higher Degree in Estate Management or other cognate disciplines, as well as the passing of relevant professional examinations. Akinbogun (2018) noted that a good real estate practise requires advanced training from a certified higher education institution.

Estate management is offered both at polytechnics and universities as an academic discipline in Nigeria. Valuation learners are required to be educated and properly prepared with basic knowledge of the concepts and methodologies of property valuation. The teaching of real estate students on valuation methodologies over time has adopted two distinct techniques, namely conventional (traditional) and contemporary valuation techniques. This study assesses students' perception of property valuation techniques in selected tertiary institutions in Nigeria to identify knowledge gaps. The research questions this study sought to answer include what are the levels of awareness of conventional and contemporary property valuation techniques by students in tertiary institutions? What are the levels of understanding of conventional and contemporary property valuation techniques by the students? What are students' views on the teaching and learning of property valuation techniques in the tertiary institutions? The remainder part of the paper is organised as follows: an exposition of property valuation techniques is presented in the next section (section 2); the methodology adopted for this analysis is given in section 3; this is followed by the results and discussion in section 4 while concluding remarks are contained in section 5.

## LITERATURE REVIEW

### **Property investment valuation techniques in context**

Property valuation is the means of deciding the value of a piece of real estate at a given point in time for a specific reason. Valuation subsists as a subject because of the ambiguity that exists among potential buyers, sellers, investors and others. According to Kinnard Jr. (2001), the uncertainty is due in part to the complexities of real estate and the uninformed, incomplete and complicated character of the property market. Property valuation methodology "is rooted in discussions devoted to the category of value and the principles of its measurement" (Zrobek et al., 2014, p. 7). Udo (2003) describes property investment valuation as an exercise involving the use of mathematical model to provide an objective answer on how a group of investors (representing the market) assess the present value of a property. Baum and Mackmin (1989) also submitted that property investment valuation requires careful consideration of a number of variables before figures can be substituted in mathematical formula or model that represents real-life situation. According Li et al. (2015), property valuation is an activity in which the valuer in line with the valuation purpose selects the appropriate valuation method and on the basis of a quantitative study of the factors affecting real estate values, estimates the objective value of the real estate. The methods used in property investment valuation are systematic and established. Different methods exist for accomplishing a property valuation assignment. The appropriateness of each property valuation method is determined by the intent of the valuation, the property's nature and the availability of data. Over the years, two broad classification of property valuation methods have been developed, namely, conventional and contemporary techniques.

### **Conventional property valuation techniques**

The conventional property valuation techniques are the historically formed valuation methodologies. Valuation methods grouped under conventional techniques include the investment (income capitalization) method, cost (contractors') method, comparative (sales) method, profits (accounts) method and the residual method. The approach to value determination via the above-mentioned methods varies from one method to another. The investment method determines the value of a property by reference to the property's actual or potential income. The investment method or income capitalization method converts income, especially initial income to value by means of compound interest-based multipliers (OLOke et al., 2017). On the other hand, the cost or contractors' method utilises the construction cost; property's value is arrived at by recourse to the cost of replacing the property. Cost method assumes that the value of the property equals the value of the site plus the replacement cost of that property. The method estimates the replacement costs of a modern comparable property and subsequently, make allowance for the age and condition of the subject property (Ifediora, 1993). Cost method is usually applied in a situation where there is a lack of data for other valuation methods; where the property is new or specialised in nature and there is no sufficient evidence of recent transactions in the open market (Onyejiaka et al., 2015). Meanwhile, the comparative or sales valuation method relies on evidences from current market transactions (lettings/sales) of comparable properties. Comparable factors such as size, location, condition etc. are considered and

analysed. Adjustments are subsequently made for observed differences (Sarip, 2005). Determination of value employing the profits or accounts 'method is based on the volume of trade or business carried on in the property. Profit method is used for properties which are seldom the object of transactions in the market and whose values depend primarily on their earning potentials. Such properties include restaurants, hotels, cinema etc. (Zrobek et al., 2014). The Residual method is used to assess the market value of undeveloped land or property under construction (Kupec and Dlask, 2020). Residual method of valuation could also be used to estimate the value of properties with redevelopment potentials (whose current use can be changed to something more profitable). According to Skarzynski (2006), residual valuation method is the most useful method for valuing property that has potential value as a result of increased investment in rebuilding, extension, refurbishing, modernisation etc. and which can bring return of the capital and profit. The property's value in its present status, is the gap between the property's value after redevelopment and the total construction cost, taking into account the developer's profit (Skarzynski, 2006).

### **Contemporary property valuation techniques**

The contemporary valuation techniques are categorized as Statistical methods, Discounted Cash Flow (DCF) models, Geographic Information System (GIS) methods and Neural Networks.

The statistical methods are said to be entirely objective as values are calculated on the basis of measurable characteristics of the property and its location. Statistical valuation approaches comprise of Hedonic Models, House Price Index and Automated Valuation Models. Besides, the statistical approaches comprise a variety of analytics approaches, such as linear and non-linear multiple regressions, genetic algorithms, time series and fuzzy logic among others (Zeicu et al., 2017).

The DCF models estimate property value by discounting of streams of future income. The variants of the DCF models are Equated Yield Technique, Real Value Approach, Real Value/Equated Yield Hybrid and Rational Approach (Salau, 2012 and Udoekanem, 2012). Baum and Crosby (1995) posited that all the variants of Discounted Cash Flow (DCF) demonstrate the same explicit cash flow projection and capitalisation process.

GIS is defined by Environmental Systems Research Institute (ESRI), (1990) as "an organized collection of computer hardware, software, geographic data and personnel designed to efficiently capture, store, update, manipulate, analyse and display all forms of geographically referenced information". In property valuation, GIS is used to record all information about a property's value and display it as spatial-based information in a digital format (Oud, 2017). GIS technologies, according to Oud, allow for the quantification of information that was traditionally gathered in a subjective manner, such as the property's spatial variables, including location, accessibility, view distance etc. Previous studies such as Rodriguez et al. (1995), Wyatt (1997) and Castle (2000) recognised that real estate valuations gained from the use of GIS in a number of ways.

Neural network is an artificial intelligence model uniquely inspired to replicate the human brain's learning process (Soni and Sadiq, 2015). Neural networks as computational methods or systems are designed to perform tasks (computation)

by learning from given example without necessarily following specific rules or without specific prior knowledge of the tasks. However, they generate results from the example that they process (Peter et al., 2020). The use of neural networks in real estate valuation can be divided into two categories: identifying real estate features that have a significant impact on their value and determining real estate values. Abidoeye and Chan (2015) confirmed that the predictive accuracy and reliability of neural networks have led to its application in property valuation studies.

Meanwhile, it is worthy to mention that the application of the conventional techniques in property investment valuations has been strongly criticised for being unreliable. The conventional techniques are thought to be unreliable because they are based on an intuitive adjustment of the relevant variables. "The economic environment in which the professional operates has witnessed rapid changes in terms of emerging investment alternatives, financing options and more sophisticated clients" (Mohammed et al., 2016, p.26). The steadily advancing vagaries in the economy of nations call for the need to adapt to evolving circumstances. Thus, in the light of ever-changing economic realities, there are concerns that "conventional valuation methods were no longer able to achieve the expected results" (Bello and Bello, 2007, p.3). The conventional methods were criticised as technically inappropriate in an inflationary economy and failing to offer a comparative basis between property investment and other alternative investments in capital market (Mallinson, 1994; Trott, 1980). As a consequence, the contemporary techniques were developed and thoroughly explored. The contemporary property valuation techniques are structured to resolve the concerns of conventional valuation techniques. Contemporary valuation techniques are specifically designed to be explicit in the analysis of the pertinent variables (Ajayi, 2006). There has been a significant shift from conventional to contemporary techniques in the global valuation practices. Mohammed et al. (2016) attributes the changes in the methodology of investment valuation to factors such as the changing needs of investors triggered by changes in the economic climate (inflation, recession, emergence of new form of investments etc.).

However, despite the increasing influence of the contemporary valuation techniques in international valuation practices, Bello and Bello (2007) reported that valuation practitioners in Nigeria have a low degree of knowledge, comprehension and application of these techniques. Bello and Bello also blamed the practitioners' lack of understanding of the theoretical foundations underlying contemporary valuation techniques on the fact that these techniques were not included in their undergraduate curricula. Conversely, Udoekanem et al. (2013) observed that undergraduate instructions on property investment valuation in recent years is based on both conventional and contemporary valuation techniques. Udoekanem et al. further claimed that students' overall level of understanding was good in basic topics which are aspects of the conventional valuation techniques and low for contemporary valuation techniques. Oloke et al. (2017) also suggested that some aspects of the fundamentals of property investment valuation are not satisfactorily taught. Therefore, this study seeks to assess the perception of property investment valuation techniques among students in selected Nigerian tertiary institutions intending to highlight crucial areas in which valuers' tutoring in property investments valuation techniques in the country needs to be strengthened.



## METHODOLOGY

Property investment valuation is a course in estate management education. The target population for this study comprises students of two Polytechnics and two Universities offering estate management as an academic discipline in Southwest Nigeria. The polytechnics considered are Federal Polytechnic Ede and Yaba College of Technology, Yaba. On the other hand, Obafemi Awolowo University, Ile-Ife and University of Lagos were selected for the study. The sample frame for this study comprised of all the graduating estate management students in these four institutions i.e., the HND II students in the Polytechnics and 500-level students in the Universities. The graduating students were considered suitable for this study because, having been tutored on property investment valuation at various levels for 3 to 4 academic years, they are expected to have a better understanding of the course than the lower-level students. Thus, they are able to give reliable responses to the research questions. In line with the methodology of Finlay and Tyler (1991) and Bello (2003), survey research design was adopted in this work to elicit the students' knowledge of property investment valuation techniques. Specifically, this study sought to assess the level of awareness and understanding of property investment valuation techniques among students and also, the students' views on the teaching and learning of property investment valuation techniques in tertiary institutions.

Data were obtained through questionnaire administration using purposive sampling. A total of 258 copies of questionnaire were distributed to graduating real estate students in the four tertiary institutions comprising 98, 51, 46 and 63 students of Federal Polytechnic Ede, Yaba College of Technology, Yaba, Obafemi Awolowo University Ile-Ife and University of Lagos, respectively. However, a total of 114 (representing a 44.2% response rate) were properly completed and found suitable for analysis. The questionnaire consisted of four sections. The first section focused on the profile of the students. The second and third sections examined the students' level of awareness and understanding respectively, of property investment valuation techniques while their perceptions about teaching and learning of property investment valuation techniques was the focus of the fourth section. Under sections 2 – 4, the students were asked to rate their responses on a 5-point Likert scale. The Likert scale is capable of handling the respondents' level of agreement to questions. The numerical values assigned to respondents rating in the 5-point Likert scale used in this study comprised of 1 - not aware to 5 - extremely aware (for level of awareness), 1 - very poor to 5 - very good (for level of understanding) and 1 - strongly disagree to 5 - strongly agree (for opinions on the teaching and learning of property valuation techniques). Before analysing the data, the reliability coefficient of the items being rated by respondents was determined using the Cronbach's alpha test.

The data analysis methods employed in this study include frequency counts, percentages, mean scores and standard deviation. Data collected were analysed through EXCEL. The responses from the questionnaire on the profile of the respondents were analysed using frequency counts and percentages. On the other hand, mean score and standard deviation were used to analyse the respondents' responses regarding awareness, understanding as well as teaching and learning of property investment valuation techniques. In this study, the responses to each

Likert-type item were summed across respondents. Next, means and standard deviations were computed for each item. The overall respondents 'opinions on the questions raised were interpreted based on the mean scores obtained. Similar studies such as Oloke et al. (2017) and Ayodele (2018) employed 5-point Likert scale, mean scores analysis and standard deviation to assess respondents 'opinions. For the purpose of this study, mean score is determined as follow:

$$\frac{1n_1 + 2n_2 + 3n_3 + 4n_4 + 5n_5}{N} \quad (i)$$

Where:

n1 = number of respondents who answered not aware, very poor and strongly disagreed.

n2 = number of respondents who answered slightly aware, poor and disagreed

n3 = number of respondents who answered moderately aware, fair and undecided

n4 = number of respondents who answered very aware, good and agreed

n5 = number of respondents who answered extremely aware, very good and strongly agreed

N = total number of questionnaires retrieved.

To develop the standard deviation values, the weights assigned to respondents ' rating were squared. The squared weights were then used to compute the second mean for each Likert-type item within the set. Next, the standard deviation value was computed as the square root of the difference between the second mean and the first mean for each Likert-type item. The second mean score is determined as follows:

$$\frac{1n_1 + 4n_2 + 9n_3 + 16n_4 + 25n_5}{N} \quad (ii)$$

## RESULTS AND DISCUSSION

This section presents and interprets the results on students 'perception of property valuation techniques in selected tertiary institutions in Nigeria. The findings are organised and discussed by the research questions. The first subsection presents the level of awareness of property valuation techniques among students. The level of understanding of property valuation techniques by the student were presented in the second subsection. The third subsection captures the consensus opinion of students on the level of awareness and understanding of property valuation techniques. In the last subsection, students 'views on the teaching and learning of property valuation techniques in Nigerian tertiary institutions were discussed. The students 'profile is presented in Table 1 below.

The profile of the respondents as shown in Table 1 revealed that the study includes students from different educational backgrounds, gender, age groups and marital statuses. From Table 1, most of the respondents (57.0%) were HND students. The gender distribution revealed that 61.4% of the respondents were male. Also, 39.5% of the students surveyed were below 25 years old. Over one-half (57.5%) were age 25 to 29 and 7.0% were age 30 and older. The marital status showed that the majority of the respondents (94.7%) were single.

**Table 1: Profile of the student respondents**

Variables	Frequency	Percentage
Mode of study		
HND	65	57.0
BSc	49	43.0
Gender		
Male	70	61.4
Female	44	38.6
Age		
Below 25	45	39.5
25-29	61	57.5
30 and older	8	7.0
Marital status		
Single	108	94.7
Married	6	5.3

Source: Field Survey, 2020

### Level of awareness of property investment valuation techniques

Property valuation methods were group into two categories; conventional and contemporary techniques. Respondents were asked to rate their degree of awareness of various property valuation techniques. The responses based on each category of property valuation techniques were presented in Table 2 below.

**Table 2: Students' awareness of property investment valuation methods**

Valuation Methods	NA	SA	MA	VA	EA	Total	Mean score	Std. Dev.	Remark
Conventional Techniques									
Investment Method	0	8	13	57	36	114	4.06	3.6250	Very aware
Cost method	0	7	16	47	44	114	4.12	3.6921	Very aware
Comparative method	0	8	19	51	36	114	4.01	3.5811	Very aware
Profit method	0	11	23	42	38	114	3.94	3.5343	Very aware
Residual method	0	19	30	33	32	114	3.68	3.3166	Very aware
Contemporary Techniques									
DCF models	0	21	31	34	28	114	3.61	3.2390	Very aware
Statistical methods	30	31	30	15	8	114	2.47	2.2595	Slightly aware
Neural networks	38	30	26	14	6	114	2.29	2.1026	Slightly aware
GIS method	37	32	23	12	8	114	2.29	2.1068	Slightly aware
Capital asset pricing model	36	32	25	13	8	114	2.34	2.1562	Slightly aware

Source: Analysis of surveyed data (2020)

(NA= Not Aware; SA= Slightly Aware; MA= Moderately Aware; VA= Very Aware; EW= Extremely aware)

Decision rule: Mean score 1.00-1.49 = Not aware; 1.50-2.49 = Slightly aware; 2.50- 3.49 = Moderately aware; 3.50-4.49 = Very aware; 4.50-5.00= Extremely aware.

From Table 2, the findings show that the respondents' level of awareness of both the conventional and contemporary valuation techniques. The results in Table 2 reveal that all the property valuation methods listed under the conventional techniques have mean values ranging between 3.68 and 4.12, suggesting that the respondents are very aware of the conventional property valuation techniques comprising the investment, cost, comparative, profit and residual methods. On the other hand, the level of awareness of the contemporary valuation techniques among the respondents indicate that the students are very aware of the discounted cashflow models with mean value of 3.61 and slightly aware of statistical approaches, neural network, GIS approach and capital asset pricing model with mean values ranging between 2.29 and 2.47.

### Level of understanding of property investment valuation techniques

Students' responses concerning their level of comprehension of the conventional and contemporary valuation techniques together with the mean values and standard deviations were presented in Table 3. The results revealed that the respondents have good understanding of the investment, cost and comparative methods with mean values of 3.78, 4.05, and 3.94, respectively. On the other hand, profit and residual methods with mean value of 3.61 each suggest that respondents have fair understanding of these methods. Furthermore, analysis on the contemporary valuation techniques shows that discounted cash flow models have the highest mean value of 3.53, which indicates a fair level of understanding of discounted cash flow models among the respondents. However, level of understanding of the other four contemporary valuation techniques among the respondents revealed that they are poorly understood with respective mean values of 2.59, 1.92, 1.93 and 2.11 for statistical approaches, neural network, GIS approach and capital asset pricing model.

Oloke et al. (2017) also reported that some aspects of the fundamentals of property investment valuation are not satisfactorily taught and Nigerian students still find it difficult to comprehend valuation techniques.

**Table 3: Students' level of understanding of property investment valuation methods**

Valuation Techniques	VP	P	F	G	VG	Total	Mean score	Std. Dev.	Remark
<b>Conventional Techniques</b>									
Investment Method	11	5	16	48	34	114	3.78	3.4565	Good
Cost method	4	4	17	46	43	114	4.05	3.6539	Good
Sales Comparative method	4	5	21	47	37	114	3.94	3.5541	Good
Profit method	7	11	20	57	19	114	3.61	3.2525	Fair
Residual method	4	17	26	40	27	114	3.61	3.2579	Fair
<b>Contemporary Techniques</b>									
DCF models	13	10	26	34	31	114	3.53	3.2498	Fair
Statistical methods	23	34	35	11	11	114	2.59	2.3508	Poor
Neural Networks	51	40	9	9	5	114	1.92	1.7321	Poor
GIS methods	50	39	13	6	6	114	1.93	1.7472	Poor
Capital asset pricing model	39	48	11	8	8	114	2.11	1.9149	Poor

Source: Analysis of surveyed data (2020)

(VP = Very Poor; P = Poor; F = Fair; G = Good; VG = Very Good)

Decision rule: Mean score 1.00-1.49 = Very poor; 1.50-2.49 = Poor; 2.50-3.49 = Fair; 3.50-4.49 = Good; 4.50-5.00 = Very good

Meanwhile, beyond assessing the respondents' levels of awareness and understanding of conventional and contemporary techniques on individual valuation methods, this study equally analysed on an overall, the respondents' ratings to determine the consensus opinion on the levels of awareness and understanding of conventional and contemporary valuation techniques as presented in Table 4. This assessment was necessary to offer insight as to the students' overall responsiveness regarding conventional and contemporary valuation techniques in Nigerian tertiary institutions.

### Students' consensus opinion on the level of awareness and understanding of property valuation techniques

To determine respondents' consensus views on the levels of awareness and understanding of conventional and contemporary valuation techniques in Nigerian tertiary institutions, all respondents' responses for individual valuation methods under the two grouping; conventional and contemporary valuation techniques were analysed to assess their group mean and interpreted on the basis of the group mean value. The results were shown in Table 4.

**Table 4: Students' consensus opinion on the level of awareness and understanding of property valuation techniques**

Factors	Techniques	Group mean	Consensus opinion
Level of awareness	Conventional	3.96	Very aware
	Contemporary	2.63	Moderately aware
Level of understanding	Conventional	3.80	Good
	Contemporary	2.41	Poor

Source: Analysis of surveyed data (2020)

The results show that awareness and understanding levels are higher for conventional valuation techniques on an aggregate with group mean values of 3.96 and 3.80, respectively. These results suggest that on an overall, real estate student in Nigerian tertiary institutions are very aware and have good understanding of the conventional valuation techniques. However, for the contemporary valuation techniques, the group mean values are 2.63 and 2.41 for levels of awareness and understanding respectively. On the overall, the students' responses demonstrated a moderate awareness and poor understanding of contemporary valuation techniques. This result is consistent with Udoekanem et al.'s (2013) claim that students' overall level of understanding was low in contemporary property investment valuation techniques.

### Students' perceptions on teaching/learning of property investment valuation methods

Further analysis focused on students' views concerning teaching and learning of property valuation techniques in the tertiary institution intending to highlight crucial areas requiring further development in the teaching and learning of

property investments valuation techniques in the country. The results were presented in Table 5 below.

**Table 5: Students' perceptions on teaching/learning of property investment valuation Techniques**

Opinions	SD	D	U	A	SA	Total	Mean value	Consensus opinion
Property valuation techniques are difficult to comprehend	23	24	28	28	11	114	2.82	Undecided
The teaching of property investment valuation methods is not detailed	8	17	19	51	19	114	3.49	Undecided
Most illustrations in property valuation classes are hypothetical	17	9	5	47	36	114	3.67	Agreed
Students should be given real-world property valuation problems to solve	7	6	5	30	66	114	4.25	Agreed
Practical exercises will facilitate a better understanding of property valuation techniques	0	7	0	32	75	114	4.53	Strongly agreed
Only the conventional valuation techniques are being taught	39	57	8	10	0	144	1.51	Disagreed
None of the contemporary valuation methods is being taught	40	53	10	11	0	114	1.92	Disagreed

Source: Analysis of surveyed data (2020)

(SD=Strongly Disagree; D=Disagree; U=Undecided; A=Agree; SA=Strongly Agree)

Decision rule: Mean score 1.00-1.49 = Strongly Disagree; 1.50-2.49 = Disagree; 2.50- 3.49 = Undecided; 3.50-4.49 = Agree; 4.50-5.00= Strongly Agree.

From the results in Table 5, the respondents generally assent to enquiries regarding hands-on application in the teaching and learning of property investment valuation techniques. The items on the subject of real-live application were the three highly rated opinions having a mean value of at least 3.67. Most of the respondents strongly hold that practical-based training would promote a better understanding of property valuation techniques with the highest mean value of 4.53. In addition, respondents are generally undecided about whether property investment valuation techniques are difficult to understand (mean value = 2.82) and the teaching of property investment valuation techniques is not detailed (mean value = 3.49). Moreover, respondents disagreed on the opinion that only the conventional valuation techniques are being taught at undergraduate level in Nigerian tertiary institutions. This result suggests that contemporary valuation techniques are currently being taught at undergraduate level in Nigerian tertiary institutions in line with Udoekanem et al.'s (2013) submission.

## CONCLUSIONS

This study assessed students' perception of property valuation techniques in selected tertiary institutions in Nigeria to identify knowledge gaps. Specifically, this study assessed the level of awareness and understanding of property investment valuation techniques among students and also, the students' views on the teaching and learning of property investment valuation techniques in tertiary institutions. The results revealed that awareness and understanding levels are higher for

conventional valuation techniques; group mean values of 3.96 and 3.80, respectively, suggest the students are very aware and have good understanding of the conventional valuation techniques. Conversely, the students demonstrated a moderate awareness and poor understanding of contemporary valuation techniques with group mean values of 2.63 and 2.41, respectively. Also, the respondents strongly agreed that practical-based training would promote a better understanding of property valuation techniques. These results have implication on the future of real estate practice in Nigeria. Poor understanding of the contemporary valuation techniques implies that the respondents who are the future valuation practitioners would face challenges employing the contemporary techniques in real estate practice. Remarkably, property investment valuation is no more a strictly expert-based business. The real estate profession is changing, particularly in terms of investment valuation, as real estate is increasingly becoming a global business. The profession is experiencing significant transformation in the valuation process and methods. Contemporary valuation techniques have transformed global valuation practise, which has been largely influenced by today's clientele's 'call for a more explicit and objective method for arriving at a value estimate. The new trend in the global market is for real estate investment to be viewed as part of a broader investment area rather than in isolation. Therefore, there is a need to develop property valuation skills in line with global valuation practices. To this end the academics in the Nigerian tertiary institutions need to place a greater emphasis on the teaching of contemporary valuation techniques. In addition, a practical-based property valuation curriculum in the Nigerian tertiary institutions is needed to equip graduates with the knowledge that aligns with the needs of the property investment market.

## LIMITATIONS

As with most research, the results of this study, must be viewed in the light of methodological limitations. The study was limited to only four tertiary institutions with data collected from only 44.2 % of the study population. Meanwhile, the opinions expressed by the remainder of the sample's respondents aligned with the responses in the analysed questionnaire. Hence, the researchers believe that the responses obtained and analysed were generally applicable in the tertiary institutions. This assertion notwithstanding, further study involving a larger sample is recommended.

## REFERENCES

- Abidoye R. B., & Chan, A. P. C. (2017), "Artificial neural network in property valuation: application framework and research trend", *Property Management*, Vol. 35 No. 2, pp. 00-00. [10.1108/PM-06-2016-0027](https://doi.org/10.1108/PM-06-2016-0027)
- Ajayi, C. A. (2006), "Towards a new direction in property valuation paradigm", in A. O Okewole; S.A. Daramola; C.A. Ajayi; O.A. Ogunba and K.T. Odusami (Eds). *The Built Environment, Innovation Policy and Sustainable Development Covenant University Ota Ogun State*.
- Akinbogun, S. P. (2017), "Admission into real estate undergraduate education in Nigeria universities; the clog in the wheel", *Property Management*.  
<https://doi.org/10.1108/PM-04-2017-0030>

- Ayodele, T. O. (2018) "Career choice of real estate students in Nigeria: The explaining influences in comparative perspective", *Property Management*. <https://doi.org/10.1108/PM-02-2018-0013>
- Baum, A., & Crosby, N. (1995), "Property Investment Appraisal" London: International Thomson Business Press.
- Baum, A., & Mackmin, D. (1989), "The Income Approach to Property Valuation 3rd ed.", London: Routledge.
- Bello, O. M. (2003), "The Economic Benefit of Borrowing to finance Rental Housing in Nigeria". *The Nigerian Bankers, Journal of the Chartered Institute of Bankers of Nigeria*, pp. 35 – 39.
- Bello, M. O., & Bello, V. A. (2007), "The influence of contemporary models on valuation practice in Nigeria". Paper presented at the FIG Working Week, Hong Kong.
- Castle, G. H. (2000), "Property Valuation: Sales Appraisals Made Easy", *Business Geographics*, Vol. 8 No. 8, p. 22.
- ESRI (1990), "Understanding GIS: The ARC/INFO Method", Redlands, California: Environmental System Research Institute.
- Finlay, P. N., & Tyler, S. B. (1991), "The Performance Measurement of Property Investments". *Journal of Property Valuation and Investment*, Vol. 9, pp. 295 – 312.
- Ifediora, G. S. A. (1993), "Appraisal Framework", Enugu: Iwuba Ifediora and Associates.
- Ifediora, B. U. (2005), "Valuation Mathematics for Valuers and Other Financial and Investment Analysts", Enugu: Immaculate Publications Ltd.
- Kinnard, Jr., W. N. (2001), "New thinking in appraisal theory", *The Appraisal Journal*, Vol. 69 No. 3, pp. 235–243.
- Kupec, J., & Dlask, P. (2020), "Residual method used for commercial real estate valuation and its sensitivity", *Business and IT*, Vol. X No. 1, pp. 12-21. <https://doi.org/10.14311/bit.2020.02.02>
- Li, K., Wen, J., & Quan, L. (2015), "Teaching design of property valuation practice course in vocational college", *SHS Web of Conferences* 17, 01020. <https://doi.org/10.1051/shsconf/20151701020>
- Mallinon, M. H. (1994), "Report on the RICS President's Working Party on Commercial Property Valuation", Royal Institution of Chartered Surveyors, London.
- Mohammed, M. I., Omirin, M. M., Singhry, I. M., & Auwal, U. (2016), "Application of discounted cashflow (DCF) models in the valuation of investment properties in Nigeria. *Int. J. Built Environment and Asset Management*, Vol. 2 No.1, pp. 25–36.
- Oud, D. A. J. (2017), GIS based property valuation, MSc Thesis, Delft University of Technology (DUT), University of Twente (UT), ITC Utrecht University (UU) and Wageningen University and Research (WUR).
- Onyejiaka, J. C., Ifeanyichukwu, E., & Emoh, F. I. (2015), "Challenges of using the cost method of valuation in valuation practice: a case study of selected residential and commercial properties in Awka and Onitsha, Anambra state, Nigeria", *International Journal of Civil Engineering, Construction and Estate Management*, Vol. 3 No. 2, pp. 16-35.



- Oloke, O., Iroham, O., Peter, N., & Oletubo, A. (2017), "Empirical assessment of student's perception of the teaching and learning of fundamentals of property valuation in Nigeria's tertiary institutions", Proceedings of ICERI2017 Conference 16th-18th November, Seville, Spain, pp. 5921-5928.
- Peter, N. J., Okagbue, H. I., Obasi, E. C. M., & Akinola, A. O. (2020), "Review on the application of artificial neural networks in real estate valuation", International Journal of Advanced Trends in Computer Science and Engineering, Vol. 9 No. 3, pp. 2918 -2925. <https://doi.org/10.30534/ijatcse/2020/66932020>
- Rodriguez, M., Sirmans, C. F., & Marks, A. P. (1995), "Using Geographic Information System to improve real estate analysis", The Journal of Real Estate Research, Vol. 10 No. 2, pp. 163-173.
- Salau, T. U. (2012), Basics of Property Valuation, Bauchi, Nigeria: Liberty Graphiclink Nigeria.
- Sarip, A. G. (2005), "Integrating artificial neural networks and GIS for single- property valuation", 11th Pacific Rim Real Estate society (PRRES) Conference, Melbourne University, Australia, 23<sup>rd</sup> – 27th January. <https://citeseerx.ist.psu.edu/viewdoc/download?doi=10.1.1.119.7897&rep=rep1&andtype=pdf>
- Skarzynski, A. (2006), "Residual method of property valuation", Technological and Economic Development of Economy, Vol. 12 No. 3, pp. 253-256. DOI: 10.1080/13928619.2006.9637749
- Soni, A. K., & Sadiq, A. A. (2015), "Real estate valuation using artificial neural network (ANN)", International Journal of Science, Technology and Management, Vol. 04 No. 05, pp. 99-105. [www.ijstm.com](http://www.ijstm.com)
- Trott, A. (1980), Property Valuation Methods: Interim Report, Polytechnic of the South Bank Royal Institution of Chartered Surveyors, London.
- Udoekanem, N. B. (2012), "The relevance of contemporary valuation techniques in the determination of buy-out value of leasehold properties in Uyo, Nigeria. Built Environment Journal, Vol. 9 No. 1, pp. 13-26.
- Udoekanem, N. B., Adoga, D. O., & Kuma, S. S. (2013), "An evaluation of students' perspectives on the teaching and learning of property investment valuation in a Nigerian University", Academic Journal of Interdisciplinary Studies, Vol. 2 No. 1, pp. 169 – 177.
- Wyatt, P. (1997), "The development of a GIS-based property information system for real estate valuation", International Journal of Geographical Information Science, Vol. 111 No. 5, pp. 435-450.
- Zeicu, S., Onose, D., Ortelecan, M., & Palamariu, M. (2017), "Statistical modeling applied in real estate valuation", RevCAD Journal of Geodesy and Cadastre, Vol. 22, pp. 243-252. <https://www.cceol.com/search/article-detail?id=811380>
- Zrobek, S., Kucharska-Stasiak, E., Trojanek, M., Adamiczka, J., Budzynski, M., Cellmer, R., Dabrowski, J., Jasinska, E., Preweda, E., & Sajnog N. (2004), "Current Problems of Valuation and Real Estate Management by Value". Croatian Information Technology Society, GIS Forum University of Warma and Mazury Olsztyn, Poland. <https://depot.ceon.pl/handle/123456789/8575>

## APPENDIX

### Questionnaire for a study on the Learning of Valuation Methods in Tertiary Institutions

#### Section 1

1. Gender: Male [ ] Female [ ]
2. Age: 18 – 24 years [ ] 25 – 29 years [ ] 30 years and older [ ]
3. Mode of study: HND [ ] B.Sc. [ ]
4. Level of study: Final year [ ] Others (Please specify).....
5. Marital status: Single [ ] Married [ ] Divorced [ ]

#### Section 2

6. On a five-point scale -Not at all aware (NA), Slightly aware (SA), Moderately aware (MA), Very aware (VA) and extremely aware (EA), please rank your Level of awareness of the under-listed Property Investment Valuation Methods

S/n	Valuation Methods	NA	SA	MA	VA	EA
i.	Investment method					
ii.	Cost method					
iii.	Sales comparative method					
iv.	Profit method					
v.	Residual method					
vi.	Discounted Cash Flow models					
vii.	Statistical Approaches					
viii.	Neural Network					
ix	G I S. Approach					
x	Capital asset pricing model					

#### Section 3

7. On a five-point scale - Very poor (VP), Poor (P), Fair (F), Good (G), Very good (VG)), Please rank your level of understanding of the under-listed Property Investment Valuation Methods

S/n	Valuation Methods	VP	P	F	G	VG
i.	Investment method					
ii.	Cost method					
iii.	Sales comparative method					
iv.	Profit method					
v.	Residual method					
vi.	Discounted Cash Flow models					
vii.	Statistical Approaches					
viii.	Neural Network					
ix	G I S. Approach					
x	Capital asset pricing model					

□

Section 4

8. To what extent would you agree or disagree on the under listed statements as it relates to teaching and learning of property investment valuation methods (SD=Strongly Disagree; D=Disagree; U=Undecided; A=Agree; SA=Strongly Agree)

S/n	Opinions	SD	D	U	A	SA
i.	Property investment valuation techniques are difficult to understand					
ii.	The teaching of property investment valuation methods is not detailed					
iii.	Most illustrations in property valuation classes are hypothetical					
iv.	Students should be given real-world property valuation problems to solve in the classroom					
v.	Practical exercises will facilitate a better understanding of property valuation techniques.					
vi.	Only conventional valuation techniques are being taught					
vii.	None of the contemporary valuation methods is being taught					

□



# SUCTION OF CLAYEY SOIL TREATED WITH QUARRY DUST BASE GEOPOLYMER CEMENT FOR SUSTAINABLE PAVEMENT SUBGRADE CONSTRUCTION

Ezenwa Chinenye Amanamba<sup>1</sup> and Kennedy Chibuzor Onyelowe<sup>2</sup>

<sup>1</sup>*Department of Civil Engineering, Abia State University, Uturu, Abia State Nigeria*

<sup>2</sup>*Department of Civil Engineering, Michael Okpara University of Agriculture, Umudike, Abia State, Nigeria*

Suction is a very important factor in pavement subgrade materials whether treated or untreated, and it is more important with the influence of seasonal changes in moisture for hydraulically bound environments. This physical property was investigated in a cemented and uncemented clayey soil treated with quarry dust based geopolymer cement (QDbGPC). The representative clayey soil was preliminarily studied and was classified as A-7-6 group soil according to the AASHTO classification system. It was also classified according to USCS as poorly graded clay (CP) with high clay content (CH). It was further classified as highly expansive and highly plastic with plasticity index above 17%. 200g of the representative sample was further treated with synthesised QDbGPC at temperature of 20°C. The effect of the varying proportions of the treatment mixed in the proportions of 2.5, 5, 7.5, 10, 12.5, 15, 17.5, 20, 22.5, 25, 27.5, 30, 32.5, 35, 37.5 and 40% by weight of dry soil on the suction of cemented and non-cemented test soils was observed. The stabilisation procedure was conducted under varying curing time on the soil. The results obtained showed a consistent reduction in suction with increased proportion of QDbGPC and with increased curing time. But cemented soil showed a slightly higher reduction in suction than the non-cemented soil. Portland cement had high shrinkage, and less suction tendencies, though it showed lower values of suction but the difference between cemented and non-cemented soil was too small that QDbGPC can totally replace OPC because of the properties it exhibits as a modifier construction material in compacted subgrade.

Keywords: clayey soil, geopolymer cement, pavement subgrade, quarry dust, suction

## INTRODUCTION

During the state of moisture exposure to pavement foundation materials, the strength properties and consequently the durability of the foundation materials; natural or treated are affected by physical factors for instance suction or absorption

---

<sup>1</sup> engr.namba@gmail.com

<sup>2</sup> konyelowe@mouau.edu.ng

(Onyelowe and Duc, 2018). Several researchers have tried to understand how suction can be improved, especially in problematic soils.

Sauer and Monismith (1968) demonstrated that low suction values in soil samples can be achieved by compacting the soil wet of optimum for the particular compactive effort. On the flip side, compacting a soil sample dry of optimum for the particular compactive effort would result in higher suction values.

Petry and Jiang, (2007) in their study of soil suction and the behaviour of clay treated with hydrated lime and a solution of potash and ammonium lignosulfonate observed the increase in osmotic suction as the soil reacted with the chemical stabilizers.

A study conducted by Pooni et al. (2019) examined the strength of soils stabilized with enzyme-based stabilizer, taking into account the challenge of moisture fluctuation. The results showed that with addition of enzyme-based stabilizer, the strength of the soil was considerably increased, and showed evidence of maintaining the stiffness as moisture fluctuates. Hence, the enzyme-based stabilizer improves the suction of the soil.

Geopolymer cements (GPC) have been studied and discovered to possess properties that could counterbalance the effects of exposure to suction and absorption. This is achieved by withstanding exposure to moisture attack in a hydraulically bound medium, a factor dependent on the moisture sensitivity of GPCs (Davidovits, 2013).

In the present research, GPC was synthesized from highly aluminosilicate bound materials under alkali-activator medium of NaOH + Na<sub>2</sub>SiO<sub>3</sub>. These materials rich in aluminosilicates are fly ash (FA), ground granulated blast furnace or metallurgical slag (GGBFS). Quarry dust (QD) was characterized and was discovered to possess great compositions of aluminosilicates. Quarry dust (QD) is a waste product of rock quarry operation of highly aluminosilicate content, with potentials to improve the physico-mechanical properties of treated soil especially highly expansive clayey soils (Fedrigo et al., 2017). This inorganic composition gives it the highly pozzolanic properties it possesses (ASTM C618, 2014; Bui, Onyelowe and Nguyen, 2018). Geopolymers on the same hand are produced from amorphous or organic or inorganic materials of highly aluminosilicate content though with activator compounds of sodium or potassium. These alkali activators enhance the attainment of a steady state with the stoichiometric release of Si and Al in the geopolymer synthesis chain leading to polycondensation (Bui, Onyelowe and Nguyen, 2018). In the present work, it is used as a replacement for FA in the synthesis of QDbGPC, which was used to treat the test clayey soil in the proportions of 2.5, 5, 7.5, 10..., 40% by weight of the treated matrix. It is also important to note that the constituents of the GPC possess high pozzolanic properties (ASTM C618, 2014), which triggers pozzolanic reaction causing condensation and densification of the dispersed clayey soil particles. However, the synthesized product possesses cementing properties, which ensures hydration and displacement reaction of certain metallic ions. GP cements, binders and concretes have found wide application in the infrastructures development industry and exhibits great use in solid waste management, construction repair as geopolymer injection, toxic metal

immobilization and coatings (Hamidi, Man and Azizi, 2016; Gopal and Rao, 2011; Onyelowe et al., 2020).

While several works have been done to reduce the damaging effect of suction on soil stability, the application of blended QD base geopolymer for the treatment of compacted soils was investigated in the present work. However, the specific objective was to study the effect of GP cement addition on the suction potential of the treated soils, adopting the methods described by Davidovits (2013) and Hamidi, Man and Azizi (2016).

## **MATERIALS AND METHODS**

### **Materials**

The test soil sample was collected from Amaoba borrow pit on Latitude 05°26'44.288"N and Longitude 07°32'33.229"E. The disturbed sample was collected, tapped to remove lumps, sun dried for 3 days and readied for use. Quarry dust was collected as waste (by-products) of quarrying (crushed-rock) operation from Amasiri quarry site in Afikpo, Ebonyi State, Nigeria. It was sundried and stored in silo bags for the laboratory exercise. Dangote Ordinary Portland Cement (DOPC) brand was used for this exercise; corresponding to 42.5N/mm<sup>2</sup> grade. Fly Ash (FA) and Ground Granulated Blast Furnace Slag (GGBFS)/Metallurgical Slag (MS) were collected from NigerPet Structures, Uyo, Nigeria and Delta Steel Company, Aladja, Warri, Nigeria respectively. The QD based Geopolymer (GP) was synthesized in accordance with the findings of Davidovits (2013) and Hamidi, Man and Azizi (2016). According to the above research findings, the aluminosilicate materials needed in the formation of GP are FA and GGBFS or MS under the reactive influence of Sodium Hydroxide (NaOH) and Sodium Silicate (Na<sub>2</sub>SiO<sub>3</sub>) as activators with a combined molar concentration of 12 as an eco-friendly material. QD contains high concentration of aluminosilicates (Al-O-Si), maintains a highly pozzolanic property and serves well in the synthesis of GP cement. These materials are mixed in the proportion of 12% by weight Activator plus 44% by weight QD plus 22% by weight FA plus 22% by weight GGBFS (MS), following Davidovits (2013) and Hamidi, Man and Azizi (2016). The GP cement dry powder was stored for use as supplementary cementing material in the laboratory stabilization exercise.

### **Experimental Program**

The following conventional tests were conducted on the natural test soil for the purpose of characterization and classification in accordance with BS 1377-2 and Nigerian General Specification (BS 1377-2, 1990; NGS/FMWH, 1997); sieve analysis test, compaction test (Standard Proctor test), California bearing ratio test (CBR), Atterberg limit test, specific gravity test was conducted by Pycnometer method and chemical oxides composition test on the test soils and the test materials with XRF method and results were obtained. Furthermore, suction cylindrical specimens were prepared from the geopolymer treated fixed 5% cemented and uncemented soils in accordance with the standard proctor mould geometry, which were compacted in three layers and cured for 14 days under the same laboratory conditions as the unconfined compressive strength specimens. Extra specimens were prepared for each mixture to ensure accuracy and forestall time loss due to accidents. The tests were conducted in accordance with the British Standard (NGS/FMWH, 1997; BS 1924, 1990). After initial curing, the prepared specimens

were dried to steady mass at a temperature of 60°C ±5°C. Then, the height and mass of the specimens were measured as the control and standard reference values. The specimens were finally placed in a curing bowl with water level maintained at 10mm and at room temperature of 26.8°C ±2°C. The mean heights of water rising up the specimens were measured from the base of the sample specimens and equally their masses were determined at 24 hours, 48 hours and 72 hours curing periods. Suction as the percentage of the specimen height was determined and calculated as the percentage of the specimens 'dry masses (BS 1377-2, 1990; NGS/FMWH, 1997; BS 1924, 1990)

## RESULTS AND DISCUSSION

### Properties of the raw materials

The test soil sample was investigated and characterized under the laboratory conditions with the preliminary tests as presented in Tables 1& 2 and Fig. 1. The test soil was classified as A-7-6 group according to the AASHTO classification system (AASHTO, 1993). It was also classified according to USCS as poorly graded clayey soil (CP) with high clay content (CH, SP-SC). It was also classified as highly plastic soil with plasticity index above 17% and expansive (Gopal and Rao, 2011). Table 2 presents that the test materials have high aluminosilicate content and possess pozzolanic properties with aluminosilicate strength of over 70% (ASTM C618, 2014).

Table 1. Geotechnical Properties of the Test Soil

Soil properties	%passing no. 200	NMC (%)	LL (%)	PL (%)	PI (%)	C <sub>c</sub>	C <sub>u</sub>	AASHTO	USCS	OMC (%)	MDD (g/cm <sup>3</sup> )
Results	42	13	40	18	22	4.54	4.23	A-7-6	CP/CH	16	1.83

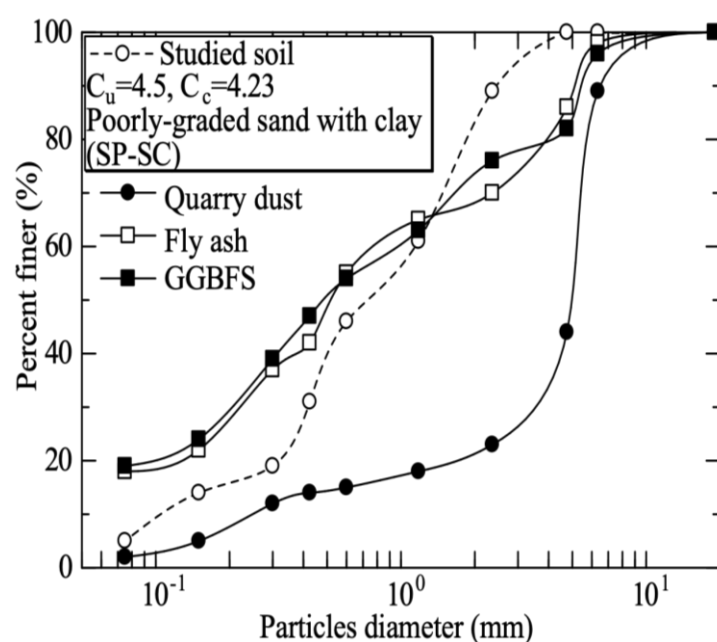

Fig. 1. Grain size distributions of studied materials

**Table 2. chemical oxide composition of the test materials**

Materials	Oxides Composition (content wt %)												
	SiO <sub>2</sub>	Al <sub>2</sub> O <sub>3</sub>	CaO	Fe <sub>2</sub> O <sub>3</sub>	MgO	K <sub>2</sub> O	Na <sub>2</sub> O	TiO <sub>2</sub>	LOI	P <sub>2</sub> O <sub>5</sub>	SO <sub>3</sub>	IR	Free CaO
Test Soil	77.73	16.65	1.42	3.22	0.07	0.89	0.02	-	-	-	-	-	-
QD	63.48	17.72	5.56	1.77	4.65	2.76	0.01	3.17	0.88	-	-	-	-
FA	63.45	4.14	1	1.23	0.78	1.09	0.01	1.78	1.89	0.71	0.11	-	0.03
GGBFS	533.45	12.34	42.10	0.05	11.45	-	-	-	0.21	-	-	-	0.40
DOPC	21.45	4.45	63.81	3.07	2.42	0.83	0.20	0.22	0.81	0.11	2.46	0.16	0.64

\*IR is Insoluble Residue; LOI is Loss on Ignition, FA: Fly Ash

QD: Quarry Dust, GGBFS: Ground Granulated Blast Furnace Slag

DOPC: Dangote Ordinary Portland cement

### Suction of the treated clayey soil under varying curing time

The effect of varying proportions of QDbGPC by weight of treated sample on the suction of the treated soil expressed as the percentage of the original mass of the treated sample under varying curing time on both cemented and non-cemented soil was presented in Fig. 2. It was observed that increased proportion of QDbGPC brought about a reduced suction on both cemented and non-cemented treated test soil and at the same time at a prolonged curing time, suction equally reduced. The consistently reduced suction with the increase in QDbGPC proportion may be due to the GPC acting as fillers to reduce the porosity of the treated soil thereby reducing suction. The reduction in porosity reduced the quantity of cementitious products occupying the matrix voids eventually reducing suction (Onyelowe et al., 2020; Meegoda and Ratanweera, 1994; Gidigasu and Dogbey, 1980). At increased QDbGPC, the treated soil achieved a more densified microstructure which does not allow the absorption of moisture due to the flocculation and agglomeration of the treated soil particles (Meegoda and Ratanweera, 1994). Hydration reaction of a GPC takes place at room temperature within 24 hours letting the material at high degrees of suction within which it gains its maximum strength and used up the highest amount of moisture needed for this process (Onyelowe et al., 2020; Austroads, 2002). This showed that if water is used as pore fluid, the influence of the mechanical factors would remain the same (Meegoda and Ratanweera, 1994; Gidigasu and Dogbey, 1980; Austroads, 2002; BS 8615-1, 2019). During this procedural exercise, the rate of suction decreased as the water content of the treated matrix increased even at increased water exposure time (Bui and Onyelowe, 2018; Hervé et al., 2009). So, at prolonged curing beyond 24 hours, the rate of moisture intake is reduced drastically hence the behaviour that was observed (Gidigasu and Dogbey, 1980).



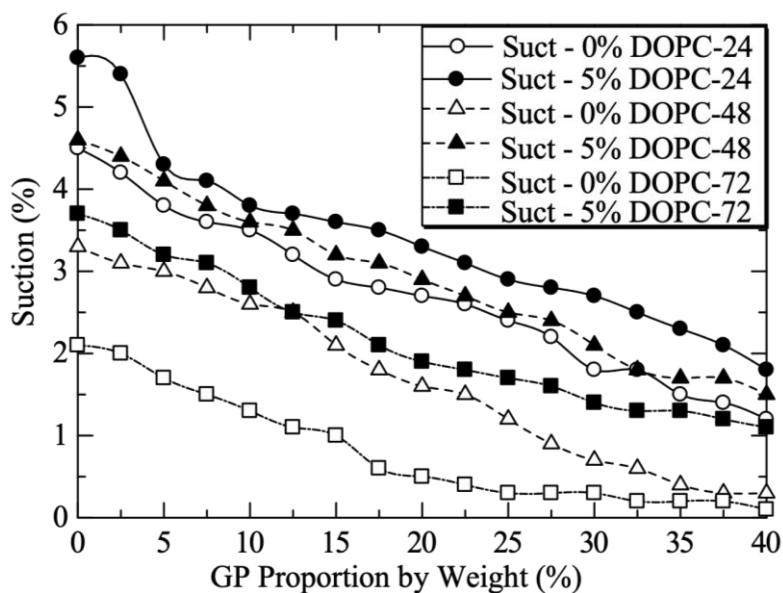

Fig.2.Effect of Geopolymer Addition on the Capillary Rise at different curing time on the treated Soil

## CONCLUSIONS

Taking into consideration the results of the laboratory exercises conducted on the QD base GPC treated soil, it can be concluded with the following remarks;

1. The test soil was tested for the basic properties and results show that it was classified according to AASHTO classification system and USCS as A-7-6 and GP groups respectively; it was also classified as a highly plastic soil with plasticity index above 17% and expansive.
2. The QD base GPC was synthesized in accordance with the conditions suggested by previous research findings, was used to treat the test soil under the laboratory conditions and was added in the proportions of 2.5, 5, 7.5, 10, 12.5, 15, 17.5, 20, 22.5, 25, 27.5, 30, 32.5, 35, 37.5 and 40% and under varying water exposure time to determine the capillary and suction behaviour and strength development behaviour of the treated soils.
3. The alkali-activated (NaOH + Na<sub>2</sub>SiO<sub>3</sub>) cement produced under dry condition provided the possibility to adapt waste inorganic materials and the properties of such cements are always better than those of ordinary Portland cement (OPC). The concentration of NaOH was kept lower than the concentration of Na<sub>2</sub>SiO<sub>3</sub> to check the excessive release of OH<sup>-</sup> which may have led to inefficient geopolymerization reaction.
4. Results from the above procedure showed that the QD base GPC treated soils demonstrated significant and consistent reduced suction with increased QD base GPC proportion by weight. This showed that the properties of GPC may be fully utilized in the stabilization protocol to achieve a hydraulically bound stabilized material that possesses resistant to high moisture exposures. This behaviour may be attributed to the properties of the constituent elements of the GPC where GGBFS produced high level of calcium and QD produced high

concentration of aluminosilicates, which contributed to prolonged hydration, calcinations, cation exchange reactions and polycondensation.

## REFERENCES

- American Administration for State Highway Officials (1993) Guide for Design of Pavement Structures. California: AASHTO.
- American Standard for Testing and Materials ASTM C618 (2014) Standard Specification for Pozzolan. West Conshohocken: ASTM.
- Austrroads (2002) Mix Design for Stabilized Pavement Materials. Sydney: Austrroads Publication.
- British Standard BS 1377-2 (1990) Methods of Testing Soils for Civil Engineering Purposes. London: British Standard Institute.
- British Standard BS 1924 (1990) Methods of Tests for Stabilized Soil. London: British Standard Institute.
- British Standard BS 8615-1 (2019) Specification for Pozzolanic Materials for Use with Portland Cement, Natural Pozzolana and Natural Calcined Pozzolana. London: British Standard International.
- Bui Van, D., & Onyelowe, K. C. (2018) 'Adsorbed Complex and Laboratory Geotechnics of Quarry Dust (QD) Stabilized Lateritic Soils'. *Environmental Technology and Innovation*, Vol. 10, pp. 355-368.
- Bui Van, D., Onyelowe, K. C. & Nguyen Van, M. (2018) 'Capillary Rise, Suction (Absorption) and The Strength Development of HBM Treated with QD Base Geopolymer'. *International Journal of Pavement Research and Technology*. <https://doi.org/10.1016/j.ijprt.2018.04.003>.
- Davidovits J (2013) Geopolymer Cement A Review. Saint-Quentin: InstitutGeopolymere.
- Fedriago W, Nunez W. P, Kleinert T. R, Matuella M. F., & Ceratti J. A. P. (2017) 'Strength, Shrinkage, Erodibility and Capillary Flow Characteristics of Cement-treated Recycled Pavement Materials'. *International Journal of Pavement Research and Technology*, Vol. 10, pp. 393-402.
- Gidigasu, M. D., & Dogbey, J. L. K. (1980) 'Geotechnical Characterization of Laterized Decomposed Rocks for Pavement Construction in Dry Sub-humid Environment'. 6th South East Asian Conference on Soil Engineering, Taipei, Vol. 1, pp. 493-506.
- Gopal R. & Rao, A. S. R (2011) Basic and Applied Soil Mechanics, 2nd Ed. New Delhi: New Age International Publishers.
- Hamidi, R. M., Man, Z., & Azizi, K. A. (2016) 'Concentration of NaOH and the Effect on the Properties of Fly Ash Based Geopolymer'. 4th International Conference of Process Engineering and Advanced Materials; *Procedia Engineering*, Vol. 148, pp. 189-193.
- Hervé, P., Lyesse, L, Tomasz, H, & Liang, B. H. (2009). 'Desiccation Cracking of Soils', *European Journal of Environmental and Civil Engineering*, 13(7-8), pp. 869-888.
- Meegoda, N. J., & Ratanweera, P. (1994) 'Compressibility of Contaminated Fine-grained Soil'. *Geotech Testing Journal, ASTM*, Vol. 17, pp. 101-112.
- Nigeria General Specification/Federal Ministry of Works and Housing (1997) Testing for the Selection of Soil for Roads and Bridges, Vol. II. Abuja: FMWH.

- Onyelowo, K. C. & Duc B. V. (2018) 'Durability of Nanostructured Biomasses Ash (NBA) Stabilized Expansive Soils for Pavement Foundation', *International Journal of Geotechnical Engineering*, doi:10.1080/19386362.2017.1422909 [Online].
- Onyelowo, K. C., Bui Van, D, Dao-Phuc, L, Onyelowo, F, Ikpa, C, Ezugwu, C, Salahudeen, A. B, Maduabuchi, M, Obimba-Wogu, J, Ibe, K., & Ihenna, L. (2020). 'Evaluation of Index and Compaction Properties of Lateritic Soils Treated with Quarry Dust Based Geopolymer Cement for Subgrade Purpose'. *Epitóanyag– Journal of Silicate Based and Composite Materials*, 72(1), pp. 12–15.
- Onyelowo, K. C., Onyia, M. E., Onyelowo, F. D. A., Bui Van, D, Salahudeen, A. B., Eberemu, A. O, Osinubi, K. J, Amadi, A. A, Onukwugha, E, Odumade, A. O., Chigbo, I. C, Saing, Z, Ikpa, C, Amhadi, T, Ugorji, B, Maduabuchi, M., & Ibe, K (2020). 'Critical State Desiccation Induced Shrinkage of Biomass Treated Compacted Soil as Pavement Foundation'. *Epitóanyag– Journal of Silicate Based and Composite Materials*, 72(2), pp. 40-47.
- Petry, T. M., & Jiang, C. P. (2007). 'Soil Suction and Behavior of Chemically Treated Clays'. *Transportation Research Record*, 2026(1), pp. 30-38. doi:10.3141/2026-04.
- Pooni, J., Giustozzi, F., Robert, D., Setunge, S., & O'Donnell, B. (2019). 'Durability of enzyme stabilized expansive soil in road pavements subjected to moisture degradation'. *Transportation Geotechnics*, 21(100255), doi:10.1016/j.trgeo.2019.100255
- Sauer, E. K., & Monismith, C. L. (1968). 'Influence of Soil Suction on Behavior of a Glacial Till Subjected to Repeated Loading'. *Highway Research Record*, 215, pp. 8-23.



---

# THE BENEFITS OF BUILDING INFORMATION MODELING IN ARCHITECTURAL EDUCATION IN NIGERIA

Elimisiemon Monday Chris<sup>1</sup>, Poopola J. O.<sup>2</sup> and Salisu A. S.<sup>3</sup>

<sup>1</sup>*Department of Architecture, Kaduna State University, Kafanchan, Kaduna State, Nigeria*

<sup>2,3</sup>*Department of Architecture, Ahmadu Bello University, Zaria, Nigeria*

The contemporary built environment is defined by complex infrastructural designs and plans. Architects are confronting and overcoming these challenges through the aid of technological innovations such as Building Information Modeling, BIM. Architects, engineers and construction, AEC professionals with the aid of BIM are to efficiently plan, design, construct, and manage buildings and infrastructure. This study examined the benefits and also identify challenges of BIM education in Nigeria among architects. A field survey was conducted using structured closed-ended questionnaires administered face-to-face and via email, WhatsApp and internet using google form to practicing architects and architects in the academia. The data collected was analysed using SPSS 16. The major findings in this study reveal the provision of BIM awareness, knowledge and skills for present and future generation of architects to achieve success in productivity and sustainable future and also collaboration between project participants in AEC industry are the most important benefits of BIM education. The major challenges to BIM education in architecture include lack of trained teachers/staff, lack of collaboration between the academia and practicing architects and lack of clear government mandate on adoption. The study concluded by recommending that NUC in collaboration with tertiary institutions through the colleges of engineering, should sponsor teachers in AEC for training on BIM in countries where such programmes are offered to enable them have the requisite knowledge to train others learners in schools of architecture.

Key words: architects, BIM, BIM education, BIM tools, BIM usage architects

## INTRODUCTION

The contemporary built environment is defined by complex infrastructural designs. The architectural, engineering, construction and operation (AECO) stakeholders have been working on ways to mitigate the negative impact of the built environment through adoption new technologies such as building information modeling (BIM) and concepts such as green or sustainable architecture.

---

<sup>1</sup> chrisdesign2000@yahoo.com

<sup>2</sup> poparchassociates@yahoo.com

<sup>3</sup> arcsalisu@gmail.com

According to Autodesk (2020), BIM is an intelligent 3D model-based process that gives architecture, engineering, and construction (AEC) professionals the insight and tools to more efficiently plan, design, construct and manage building and infrastructure. Specifically, it enables architects make better design decisions, improve building performance, and collaborate more effectively throughout the project cycle. It is widely accepted and adopted innovation in Europe, Americas and Asia that has emerged as a way to create a virtual of a construction project prior to the actual construction work in order to detect, stimulate and analysed potential problems and factors or delay encountered throughout the construction phase and after (Liu, Xie, Tivendal, & Liu, 2015; Chimhundu, 2015).

However, BIM acceptance and adoption in Africa fall behind the developed countries mentioned above in spite of high level of awareness, with South African being the country with highest adoption (Saka & Chan, 2019; Hamma-adama, Salman & Kouider, 2017 and Shakantu & Froise, 2014). The major reason for this is attributed to lack of technical skills/expertise, lack of trained staff/experts, lack of government support and legislation and lack of standards and guidelines (Abubakar, Ibrahim & Bala, 2013; Abubakar, Ibrahim, Kado & Bala, 2014; Ugochukwu, Akabogu & Okolie, 2015; Wang, Cho & Kim, 2015; Ezeokoli, Okoye & Nkeleme, 2016; Timothy, Kehinde, Fagbemi & Sadiku, 2016; Ebiloma, Daibi-Oruene & Bumaa, 2017; Onungwa & Uduma-Olugu, 2017, Hamma-adama, Galadima & Kouider, 2018).

One of the ways to address the above challenges is through BIM education. The Australia Institute of Architects and Consult Australia (2012), BIM education is the process of learning the sum of conceptual and practical knowledge relating to BIM technologies, workflows and protocols. Globally, many tertiary education systems are investing how to incorporate BIM based on contemporary industry expectations and government mandates. BIM educationists and researchers have invested huge efforts in BIM educational frameworks, designing BIM curricula, conduct BIM courses, and developing new strategies for its implementation. Others have delivered overview of BIM educational trends in the past (Becker et al, 2011, Salman 2014; Rooney 2015 in Chegou Badrinath et al, 2017; Barison & Santos 2010c, 2011; Wong et al. 2011; Lee & Dossick 2012).

This study is aim to identify the benefits BIM education in architecture in Nigeria.

## **LITERATURE REVIEW**

BIM education is the process or acquiring the necessary knowledge and required skills to generate BIM deliverables and satisfy their respective requirements. It involves data management, team collaboration and risks management, technical, procedural and regulatory (Australian Institute of Architects and Consult Australia, 2012). It encompasses both theory and practice (academia and industry), meeting the requirement of current and future professionals through learning, spreading awareness to developing highly specialized skills in tertiary institutions, industry workshop, online media and on-the-job-training (Succar, et al, 2012).

The demand for BIM education has grown significantly over the years (Becerik-Gerber et al., 2011; Lee and Hollar, 2013). Recent studies shows that most tertiary institutions in developed and developing nations are yet to run full BIM courses or

fully collaborative BIM courses between students of AEC disciplines. However, the narrative is changing is fast changing among developed countries like USA, UK and Australia. Some of the major barriers to developing BIM education in tertiary institutions include lack of resources and conservative practices at tertiary institutions (Suwal, Javaja & Salin, 2014).

Some researchers have attempted to develop empirical evidence for integrating BIM into AEC disciplines in tertiary institutions. According to Clevenger, Glick & del Puerto (2012), in US only, employers who seek BIM-ready employees (students and graduates) do not require software expertise from such employees. However, other researchers conclude that students are required to have a working knowledge of BIM, in addition BIM-compliant graduates must be able to communicate effectively and demonstrate extraordinary ability to create, share and use robust information across autonomous technologies in addition to graduates 'core skills in construction (Akanmu, Olatunji, Love, Nguyen, & Matthew, 2016; Male, Bush & Chapman, 2010; Singh, Gu & Wang, 2011 Ku & Taiebat, 2011; Gu & London (2010).

Some of the benefits of BIM education is to present and future professionals is that allow them to be further competitive and flexible in a rapidly changing Information Technology (IT) environment (Hsieh et al. 2015). It encourages collaboration among professionals in the BIM environment thereby minimizing errors and enabling professionals work on projects to create a single communication language among them (Azhar, 2011; Hardin, 2009); it equips equip engineering graduates with an adequate understanding of BIM concepts and BIM skills as a means to help achieve the successful uptake of BIM within the AEC industry (Ghosh, Parfitt & Chasey, 2013).

Although there is progress in the integration of BIM tertiary institution curricula, there are still major challenges identified in various studies. One of the major challenge is the lack of competent teaching staff (Mandhar & Mandhar, 2013; Pillay, Musonda & Makabate, 2018), new teaching methodologies; material, books and other specific sources deficiency; platform costs; difficulty in finding the required multidisciplinary, development of curricular components, and lack of rules and requirements for the curriculum implementation, professionals resistance to seek training (Sabongi, 2009; Sacks & Pikas, 2013; Checcucci, 2014; Böes, Barros Neto, & Lima, 2021). Other barriers include lack of motivation, non-uniform global accreditation, professional accreditation issues, BIM curriculum issues, and diverse BIM modeling skill requirements, BIM tool selection, BIM software licenses, BIM technical affairs, the need for BIM IT lab facilities, object libraries, and coordination tools, weak ties between industry and academia, the need for trans- disciplinary, inter-level, and multinational collaboration, and incomplete BIM curricula. BIM activists and educationalists have put effort into resolving these BIM educational issues.

Several studies have been carried out on BIM awareness level, benefits and barriers to BIM adoption in Nigeria. Computer-aided design (CAD) is being taught to students of architecture across all stages of development in Nigeria (Uwakonye et al, 2017). However, BIM is not yet reflect in the curricula of school of engineering in tertiary institutions in Nigeria. This is reflected in the emergence of obsolete graduate in the practical world (Chegu Badrinath et al, 2017 & Omotosho, 2016).

Few studies, however have been carried out on BIM education in Nigeria. Maina (2018) observe inadequate integration within the curriculum, lack of steady power, time to master skills were among the major challenges to effective use of CAD/BIM use in architectural education, government and institutional related barriers recorded the highest.

Engineering schools plays a vital role in promoting BIM concepts. The involvement of students in research projects, and the dissemination of BIM through short courses and workshops addresses the AEC community outside the school (Sampaio 2014). The NATSPEC's global summary report, based purely on responses received from a global group of parties with interest in BIM, advocated the need for TELs with backing from industry and government to fully incorporate BIM education into curricula (Rooney, 2015). This report attempted to fully document the status of BIM education/awareness by considering three key factors—education/training, initiatives/organizations, and awareness/uptake—in countries such as Canada, US, UK, the Netherlands, the Czech Republic, Finland, Norway, South Africa, China, Hong Kong, Singapore, Japan, Australia, and New Zealand (Chegu, Chang & Hsieh, 2016).

## **METHODOLOGY**

A Survey was carried out using a close-ended structured questionnaire, 100 questionnaires were distributed face-to-face and via email, WhatsApp and internet using google form to practicing architects and architects in the academia., 62 were returned. Using a 5-point Likert scale, respondents were asked to indicate their degree of agreement with the barriers on the Likert scale of 5 = strongly agree, 4 = agree, 3 = fairly agree (average), 2 = disagree, 1 = strongly disagree. The results were analyzed using mean and Relative Importance Index (RII) methods. Mean: logic to determine a cut-off mean of 3. The sum of the weight of 5,4,3,2 and 1 is 15, which is divided by 5 (number of response category: it follows from this that a response can be considered as significant when the mean score is equal or greater than 3 ( $\geq 3$ ). A response is considered insignificant if the mean score is equal or less 3 ( $\leq 3$ ). RII values of 0.75 and above were considered highly important for this study. These correspond to ratings in the upper quartile range (75% and above). RII values between 0.50 and 0.74 corresponding to the second quartile (50%-74%) are considered important. RII values below 0.5 (or median) are considered unimportant in this study.

The formula for the Relative importance index:

$$(RII) = \sum w / (A \times N) \dots, (0 \leq RII \leq 1)$$

Where:  $\sum w$  = total sum of weighting given to each factor by the respondent; A = highest weight; N = total number of respondents

## **RESULTS AND DISCUSSION**

Table 1 shows the gender of respondents in the survey. 76% of the respondents are male, while 24% are female. Majority of the respondents are M.Sc holders (66%). Predominantly 39% of the respondents are lecturers followed by consultants

and project supervisors (16% respectively). Finally, majority of the respondents are beginners in BIM proficiency (56%).

**Table 1: Demographic profile of respondents**

Item	Frequency	Percentage (%)
Gender		
Male	47	76
Female	15	24
EDUCATIONAL LEVEL		
BSc/HND	12	19
MSc	41	66
BArch or PhD	9	15
Job title		
<i>Consultant</i>	10	16
Lecturer	24	39
Supervisor	10	16
Project manager	4	6
Site engineer	5	8
Contractor	9	15
BIM proficiency		
Beginner	56	90.3
Intermediate	4	6.5
Expert	2	3.2

**Table 2: Benefits of building information modeling education in architectural practice in in Nigeria**

S/N	Item	Descriptive			
		Total	Mean	RII	Rank
	Provision of BIM knowledge and skills	298	4.80	0.96	1
	Facilitates collaboration between projects participants in AECO industry.	275	4.44	0.89	3
	Main communication method to spread technology-enabled, process-driven and policy-encouraged advances in design, construction and operation facilities.	286	4.62	0.92	2
	Competitiveness and flexibility in dynamic information technology (IT) environment.	270	4.36	0.87	4
	Improve efficiency of information exchange for architectural, engineering, construction and operation (AECO) industry stakeholders.	267	4.32	0.86	5
	Addresses the requirement of current practicing architects	255	4.12	0.82	6
	Empowers future generation of architects to achieve success in productivity, reduction in waste and fulfillment of an aesthetic and sustainable future.	286	4.62	0.92	2

Overall, provision of BIM knowledge and skills ranks the 1st with RII 0.96 (mean of 4.80). Main communication method to spread technology-enabled, process-driven and policy-encouraged advances in design, construction and operation facilities and empowers future generation of architects to achieve success in productivity, reduction in waste and fulfillment of an aesthetic and sustainable future rank 2nd



with RII 0.92 (mean of 4.62). The least benefit of BIM education (even though the mean is significant, mean of 4.12). These findings agree with previous findings (Ahn, Kwak & Suk, 2016; Miettinen & Paavola, 2014; U.S. General Service Administration (GSA), 2007; Hamdi & Leite, 2014; Samuelson & Bjork, 2014; Bynum, Issa & Olbina, 2013)

**Table 3: Challenges of building information modeling education in architectural practice in in Nigeria**

S/N	Item	Descriptive			
		Total	Mean	RII	Rank
	High cost of hardware	259	4.18	0.84	5
	High cost of software	256	4.14	0.83	6
	Lack of trained teachers/staff	288	4.65	0.93	1
	Unclear benefits of BIM education	280	4.52	0.90	4
	Lack of clear government mandate on adoption	283	4.58	0.91	3
	Lack of collaboration between academia and practicing architects.	255	4.12	0.82	7
	Lack of access to internet/high cost of internet services	287	4.64	0.93	2
	Unstable power supply.	253	4.08	0.82	8

As shown in Table 3, lack of trained teachers/staff (RII: 0.93; mean of 4.65) is the major challenge to BIM education in Nigeria. Lack of access to internet and high cost of internet services follows with a mean of 4.64 (RII: 0.93). The least challenge to BIM education in Nigeria is lack of collaboration between the academia and practicing architects (RII: 0.82; mean of 4.12). Recent findings in BIM Education in architecture is similar to these findings (Maina, 2018; Botton & Forgues, 2018; Lee, Yu & Jeong, 2015, Gheisari & Irizarry, 2016 and Ahn, Kwak and Suk, 2016).

**Table 4: Strategies for BIM education in architectural practice in in Nigeria**

S/N	Item	Descriptive			
		Total	Mean	RII	Rank
i.	Teacher/Staff BIM education	301	4.86	0.97	1
ii.	Integration into educational curricula	299	4.82	0.96	2
iii.	Curriculum preparation, development and improvement	275	4.44	0.89	5
iv.	Availability to practicing professionals	288	4.65	0.93	3
v.	Government support and legislation	285	4.60	0.92	4
vi.	Compulsory internship (hands-on experience) for undergraduate on BIM	248	4.00	0.80	6

In response to the strategies for improve BIM education in architecture in Nigeria, Teacher/staff BIM education ranks 1st with RII 0.97 (mean of 4.86). Integration into educational curricula of architect education follows with RII 0.96 (mean of 0.96). compulsory internship (hands-on-experience) for undergraduate on BIM technology is the least with RII 0.80 (mean of 4.00). Recent findings also identifies some of these factors as strategic factors that can positively influence BIM education in architecture in Nigeria (Maina, 2018; Maina et al, 2017).

## **CONCLUSION**

The aim of the study is to investigate the benefits of BIM education in architecture in Nigeria. The specific objectives are to identify the benefits of BIM education in architecture, identify major challenges to BIM education and also provide strategies that will improve BIM Education. The benefits of BIM education established in this study include provision of BIM knowledge and skills, main communication method to spread technology-enabled, process-driven and policy-encouraged advances in design, construction and operation facilities and empowers future generation of architects to achieve success in productivity, reduction in waste and fulfillment of an aesthetic and sustainable future, facilitates collaboration between project participants in AECO industry, competence and flexibility in dynamic IT environment. The major challenges to BIM education in architecture include lack of trained teachers/staff, lack of access to internet and high cost of internet services, lack of collaboration between the academia and practicing architects, lack of clear government mandate on adoption, unclear benefits of BIM education, high cost of hardware and software.

The recommendation based on the findings of this study: Stakeholder in faculty of engineering, through the department of architecture in the tertiary education systems should sponsor teachers of architecture for training on BIM in countries where such programmes are offered to enable them have the requisite knowledge to train others learners of architecture.

Second, BIM should be integrated into tertiary institutions systems educational curricula to enable both current professionals and future architects learn BIM to provide necessary competence and flexibility for practice in dynamic contemporary architectural practices. This is possible through curriculum preparation, development and improvement among BIM educationists and researchers.

Third, BIM education should be made available to practicing professionals through collaboration between the academia and industry stakeholder like department of architecture, Nigeria Institute of Architects, Architect Registration Council of Nigeria and Association of Architectural Educators in Nigeria (AARCHES).

Finally, Government support should support tertiary institutions department of architecture through legislation that will mandate the BIM adoption and education in the country.

## **REFERENCES**

- Abubakar, M., Ibrahim, Y. M., Kado, D., Bala, K. (2014). Contractors' perception of the factors affecting Building Information Modelling (BIM) adoption in the Nigerian Construction Industry. In *Computing in Civil and Building Engineering* (pp. 167-178).
- Abubakar, M., Ibrahim, Y. M., & Bala, K. (2013). Readiness of Nigerian building design firms to adopt building information modelling (BIM) technologies. *The 5th International Conference for Construction Engineering and Project Management, ICCEPM 2013.*

- Ahn, Y., Kwak, H., & Suk, Y. (2016). Contractors 'transformation strategies for adopting building information modeling. *Journal of Management in Engineering*, vol. 32, no. 1, article 05015005.
- Akanmu, A., Olatunji, O., Love, P. E. D., Nguyen, D., & Matthews, J. (2016). Auto-generated site layout: an integrated approach to real-time sensing of temporary facilities in infrastructure projects. *Structure and Infrastructure Engineering*, Vol. 12 No. 10, pp. 1243-1255.
- Azhar, S., (2011). Building information modeling (BIM): trends, benefits, risks, and challenges for the AEC industry. *Leader. Manag. Eng.* 11 (3), 241e252.
- Barison, M. B., & Santos, E. T. (2010c). BIM teaching strategies: An overview of the current approaches. *Proceedings of the International Conference on Computing in Civil and Building Engineering (ICCCBE 2010)*. Nottingham, UK: Nottingham University press.
- Barison, M. B., & Santos, E. T. (2011). The competencies of BIM specialists: a comparative analysis of the literature review and job ad descriptions. *Proceedings of International Workshop on Computing in Civil Engineering*. Reston, VA: ASCE.
- Becerik-Gerber, B., Gerber, D. J., & Ku, K. (2011). The pace of technological innovation in architecture, engineering, and construction education: integrating recent trends into the curricula. *Journal of Information Technology in Construction*, Vol. 16 No. 4, pp. 411-432.
- Becker, T. C., Jaselskis, E. J., & Mcdermott, C. P. (2011). Implications of Construction Industry Trends on the Educational Requirements for Future Construction Professionals. *Proceedings of 47th ASC Annual International Conference*. Omaha, Nebraska, United States, 6-9th April.
- Böes, J. S., Barros Neto, J. de P., Lima, M. M. X. de. (2021). BIM maturity model for higher education institutions. *Ambiente Construído*, Porto Alegre, v. 21, n. 2, p. 131-150, ISSN 1678-8621 Associação Nacional de Tecnologia do Ambiente Construído. <http://dx.doi.org/10.1590/s1678-86212021000200518>
- Botton, C., & Forgues, D. (2018). Practices and processes in BIM projects: an exploratory case study," *Advances in Civil Engineering*, vol. 2018, Article ID 7259659, 12 pages.
- Bynum, P., Issa, . R. R. A., & Olbina, S. (2013). Building information modeling in support of sustainable design and construction. *Journal of Construction Engineering and Management*, vol. 139, no. 1, pp. 24–34, 2013.
- Cefrio, *Improving Efficiency and Productivity in the Construction Sector through the Use of Information Technologies*, NRC Industrial Research Assistance Program, Quebec, Canada, 2011.
- Chegu Badrinath, A., Chang, Y., & Hsieh, S. (2016). A review of tertiary BIM education for advanced engineering communication with visualization. *Visualization in Engineering*, 4:9; pp 2-17 DOI 10.1186/s40327-016-0038-6
- Clevenger, C., Glick, S., & del Puerto, C. L. (2012). Interoperable learning leveraging Building Information Modeling (BIM) in construction education. *International Journal of Construction Education and Research*, Vol. 8 No. 2, pp. 101-118.
- Eastman, C., Teicholz, P., Sacks, R., & Liston, K. (2011). *BIM Handbook: A Guide to Building Information Modeling for Owners, Managers, Designers, Engineers, and Contractors*, John Wiley and Sons, Hoboken, NJ, USA, 2nd edition.

- Ebiloma, D. O., Daibi-Oruene, W. D., Bumaa, F. N. (2017). Application of multiple regressions on the impact of building information modelling adoption drivers on sustainable construction in Nigeria. *International Journal of Innovation and Sustainability*; 1:22-31.
- Ezeokoli, F. O., Okoye, P. U., Nkeleme, E. (2016). Factors affecting the adaptability of building information modelling (BIM) for construction projects in Anambra State Nigeria. *Journal of Scientific Research & Reports*;11(5):1-0.
- Gheisari, G., & Irizarry, J. (2016). Investigating human and technological requirements for successful implementation of a BIM-based mobile augmented reality environment in facility management practices. *Facilities*, vol. 34, no. 1/2, pp. 69–84.
- Ghosh, A., Parrish, K., Chasey, A. D. (2013). From BIM to collaboration: A proposed integrated construction curriculum. In: 2013 American Society for Engineering Education (ASEE) Annual Conference, Atlanta, Georgia. Accessed on 10th of August 2017: <https://peer.asee.org/from-bim-to-collaboration-a-proposed-integrated-construction-curriculum>.
- Gu, N., & London, K. (2010). Understanding and facilitating BIM adoption in the AEC industry. *Automation in Construction*, vol. 19, no. 8, pp. 988–999.
- Hamdim, O., & Leite, F. (2014). "Conflicting side of building information modeling implementation in the construction industry," *Journal of Legal Affairs and Dispute Resolution in Engineering and Construction*, vol. 6, no. 3, article 03013004.
- Hamma-adama, M., Galadima, Y. K., Kouider, T. (2018). Building information modelling: a tool for diffusion of information in Nigeria. In Junaid, A. M., Adedayo, O. F., Jimoh, R. A. and Oyewobi, L. O. (eds.) *Proceedings of the School of Environmental Technology international conference 2018 (SETIC 2018); contemporary issues and sustainable practices in the built environment, 10-12 April 2018, Minna, Nigeria*. Minna: School of Environmental Technology, Federal University of Technology, pages 35-43.
- Hamma-adama, M., Salman, H. S., Kouider, T. (2017). Diffusion of innovations: the status of building information modelling uptake in Nigeria. *Journal of Scientific Research & Reports*, 17(4), 1-12. DOI:10.9734/JSRR/2017/38711.
- Hamma-Adama, M., & Kouider, T. (2018). A review on building information modelling in Nigeria and its potentials world academy of science, engineering and technology. *International Journal of Civil and Environmental Engineering* Vol:12, No:11.
- Hardin, B., (2009). *BIM and Construction Management*. Wiley, Indianapolis.
- Hsieh, S., Amarnath, C. B., & Tsai, Y. (2015). On teaching BIM technology courses in civil engineering. *Proceedings of International Conference on Innovative Production and Construction, IPC 2015, 28-31st July, Perth, Western Australia, Australia*.
- Ku, K., & Taiebat, M. (2011). BIM experiences and expectations: the constructors ' perspective. *International Journal of Construction Education and Research*, Vol. 7 No. 3, pp. 175-197.
- Lee, N., & Dossick, C. S. (2012). Leveraging Building Information Modeling technology in Construction Engineering and Management education. In *Proceedings of 119th ASEE Annual Conference, San Antonio, 10-13th June*. San Antonio: ASEE.
- Lee, N., & Hollar, D. A. (2013). Probing BIM education in construction engineering and management programs using industry perceptions. *49th Annual International Conference Proceeding of the ASC, California Polytechnic State University, San Luis Obispo, CA*, pp. 467-476.

- Liu, Y., van Nederveen, S., Wu, C., & Hertogh, M. (2018). Sustainable infrastructure design framework through integration of rating systems and building information modeling. *Advances in Civil Engineering*, vol. 2018, Article ID 8183536, 13 pages
- Maina, J. J., Marafa, A. K., & Daful, C. K. (2017). Student Perception of Factors Influencing Academic Performance of Architecture Undergraduates at Ahmadu Bello University and the University of Jos. Ikem Mbamali (Ed.), *Book of Readings, National Built Environment Conference (NABECON), 2017, Positioning the Construction Industry in Nigeria for National Economic Growth, 8-10 November 2017 at the School of Postgraduate Studies, Ahmadu Bello University Zaria*. pp. 776-787.
- Maina, J. J. (2018). Barriers to effective use of CAD and BIM in architecture education in Nigeria. *IJBES 5(3)/2018*, 175-186. Published by Faculty of Built Environment, Universiti Teknologi Malaysia. Website: <http://www.ijbes.utm>.
- Male, S. A., Bush, M. B., & Chapman, E. S. (2010). Perceptions of competency deficiencies in engineering graduates. *Australasian Journal of Engineering Education*, Vol. 16 No. 1, pp. 55-68.
- Miettinen, R., & Paavola, S. (2014). Beyond the BIM utopia: approaches to the development and implementation of building information modeling, *Automation in Construction*, vol. 43, pp. 84–91.
- Miettinen, R., & Paavola, S. (2014). Beyond the BIM utopia: approaches to the development and implementation of building information modeling. *Automation in Construction*, vol. 43, pp. 84–91, 2014.
- Onungwa, I. O., & Uduma-Olugu, N. (2017). Building information modelling and collaboration in the Nigerian construction industry. *Journal of Construction Business and Management*;1(2):1-10.
- Pillay, N., Musonda, I., & Makabate, C. (2018). Use of BIM at higher learning institutions: Evaluating the level of implementation and development of BIM at built environment schools in South Africa. [www.researchgate.net/publication/327929431](http://www.researchgate.net/publication/327929431)
- Rooney, K. (2015). *BIM Education - Global Summary 2015 Update Report*. Sydney, Australia: NATSPEC Construction Information.
- Sampaio, A. Z. (2014). The BIM concept: The role of the engineering school, using technology tools to innovate assessment, Reporting, and Teaching Practices in *Engineering Education*, 190.
- Samuelson, O., & Björk, B. C. (2014). A longitudinal study of the adoption of IT technology in the Swedish building sector. *Automation in Construction*, vol. 37, pp. 182–190
- Shakantu, W., Froise, T. (2014). Diffusion of innovations: an assessment of building information modelling uptake trends in South Africa. *Journal of Construction Project Management and Innovation*. 2014 Dec 1;4(2):895-911.
- Singh, V., Gu, N., & Wang, X. (2011). A theoretical framework of a BIM-based multi-disciplinary collaboration platform. *Automation in Construction*, Vol. 20 No. 2, pp. 134-144.
- Son, H., Lee, S., & Kim, C. (2015). "What drives the adoption of building information modeling in design organizations? An empirical investigation of the antecedents affecting architects' behavioral intentions," *Automation in Construction*, vol. 49, pp. 92–99.

- Succar, B., Agar, C., Beazley, S., Berkemeier, P., Choy, R., Giangregorio, R., Donaghey, S., Linning, C., MacDonald, J., Perey, R., Plume, J. (2012). BIM education, BIM practice. In BIM in practice, Australia Institute of Architects.
- Suwal, S., Javaja, P., & Salin, J. (2014). BIM education: Implementing and reviewing "OpeBIM"- BIM for teachers. *Computing in Civil and Building Engineering*. 2151-2158. 10.1061/9780784413616.267.
- The Australia Institute of Architects and Consult Australia (2012). BIM education and BIM learner. Retrieved from [www.researchgate.net](http://www.researchgate.net)
- Timothy, O. O., Kehinde, O., Fagbemi, K., & Sadiku, A. (2016). "Exploring New Directions for the Transformation of the Built Environment in Nigeria: The Role of Building Information Modeling" *Developing Country Studies* ISSN 2224-0525 (Online) Vol.6, No.6;177-182.
- Ugochukwu, S., Akabogu, S., Okolie, K. (2015). Status and perceptions of the application of building information modeling for improved building projects delivery in Nigeria. *American Journal of Engineering Research (AJER)* 4(11):176-82.
- Wang, C., Cho, Y. K., Kim, C. (2015). Automatic BIM component extraction from point clouds of existing buildings for sustainability applications. *Automation in Construction*. 2015 Aug 31;56:1-3.
- Won, J., Lee, G., Dossick, C., & Messner, J. (2013). Where to focus for successful adoption of building information modeling within organization. *Journal of Construction Engineering and Management*, vol. 139, no. 11, article 04013014.
- Wong, K.-d. A., Wong, K. -w. F., & Nadeem, A. (2011). Building Information Modelling for Tertiary Construction Education in Hong Kong. *Journal of Information Technology in Construction*, 16, 467-476.



## THE IMPACT OF PROJECT CONTRIBUTORY FACTORS ON THE COST PERFORMANCE OF BUILDING PROJECTS

V. H. Jiya<sup>1</sup>, A. D. Ibrahim<sup>2</sup>, D. Kado<sup>3</sup> and K. Bala<sup>4</sup>

<sup>1</sup>*Department of Civil and Environmental Engineering, Faculty of Ground Engineering Air Force Institute of Technology, Kaduna, Nigeria*

<sup>2,3,4</sup>*Department of Building, Faculty of Environmental Design, Ahmadu Bello University, Zaria, Nigeria*

Construction projects are complex and vast in nature with a large number of available procurement options, participants, directions, technologies and external factors which are generally deduced as contributory factors and can influence the attainment of project objectives. These demands and pressures for the attainment of project objectives from the client have led to the consideration of the most appropriate contributory factors for a given project, being seen as an important issue in construction project performance. In view of this, the research explored the impact of project contributory factors on building project cost performance based on the attacked level of perception on the extent to which contributory factors (NPRC/PRC) impact on cost performance of building projects. To achieve this goal, the research identify projects contributory factors that impact on the cost performance of building projects and to determine the extent to which contributory factors (NPRC/ PRC) impact on the cost performance of building projects. The aim was achieved by administering 120 questionnaires to professionals in State Universal Basic Education Board (SUBEB) and Government Agencies who have handled SUBEB building projects across the twenty three local government areas in Kaduna State. The obtained data were statistically analysed using descriptive statistics. The results revealed that for non-procurement related factors, client financial stature and project size and complexities are the most popular contributory factors impacting building cost performance. The research further ascertained that for procurement related contributory factors project procurement method used and project responsibilities, contractual obligations to people and organizations are the most popular contributory factors that impact building construction cost performance. The study concluded that NPRC and PRC do exist and can impact cost performance at varying extent. The findings necessitate NPRC and PRC appropriateness by the construction professionals involved in building construction to ensure better cost performance.

Key words: building projects, cost performance, impact, project contributory factors

---

<sup>1</sup> hassvics@gmail.com

<sup>2</sup> adibrahim2@yahoo.com

<sup>3</sup> kadobbdikko@yahoo.com

<sup>4</sup> balakabri@gmail.com

## INTRODUCTION

The need to achieve project performance remains a prominent issue in construction project construction because project performance deals with the key performance indicators (KPIs) that is projects defined objectives which must be achieved. Moreover, there are numerous resources and factors which need to be efficiently considered due to the complex nature of construction projects (Soewin and Chinda, 2018; Mohmoud, 2020). Olubunmi and Ayo (2013), Idoro (2012) and Babatunde, et al. (2010) all stressed that, achieving project goals for a given project, is necessary not only to judge whether the appropriate procurement and other contributory factors are considered. The basic issue is how the adopted procurement and other project contributory factors enhances or inhibits on project performance indicators (PIs), such as cost, time, client satisfaction, quality among others in order to increase the chances of fulfilling project performance objectives and successful completion of a construction project (Omran at el., 2013).

Construction project success is often evaluated for performance dimensions cost inclusive. Cost is one of the most significant dimensions of construction project performance and the driving force of project success (Oladirin, 2013). Rahman et al. (2012) affirmed that the completion of any project within the estimated cost is the basic criteria for the success of any construction project regardless of size and complexity of project. In recent time due to the abnormal increase in the cost of projects, cost of construction projects has received the attention of most stakeholders. This is because cost is among the major considerations from inception throughout the construction project life cycle. It is however obvious from previous studies that achieving cost performance of any construction project, cost dimension performance is related to numerous project contributory factors impacting on the performance.

Project contributory factors that impact project performance are grouped into procurement and non-procurement related contributory factors Dissanayaka and Kumaraswamy (2012). CIOB (2010) supported that, procurement attributes are contributory absolutely crucial to the performance dimensions. These are the basis for the various processes that bring about the construction of project that meet the client needs known as procurement related contributory factors which contains function attributes as incorporating principal procurement sub-systems and possible choices that are there in. The procurement related contributory factors include: work package, functional grouping, payment modalities, selection methodologies and contract conditions Erikson and Westerberg (2012). Ogunsami (2013) also mentioned that other factors of client characteristics, project requirements, external environment, and contractor characteristics among others are contributory factors known as non-procurement related contributory factors are also essential in procurement process and project execution at the end impacting project performance.

In the construction industry, project performance has gained significant interest recently among both practitioners and academics. This can be seen in several efforts made by researchers to develop project performance based model for



construction project execution by Dissanayaka (1998). Cost models and validation of the model by several other researchers such as Dissanayaka and Kumaraswamy(1999), Enshassi et al (2009), Saraf (2013), Owolabi et al (2014), (Hassan, 2015). As part of effort to ensure efficient construction cost performance by this model, there is general overview by researches such as Dissanayaka and Kumaraswamy (2012), Mathonsi and Thawal (2012) that procurement related factors and non-procurement related factors must be considered on cost performance of construction projects. These factors only become useful basis for modeling and assessing cost performance of construction projects when the extent of impact of both procurement related factors and non-procurement related factors are considered on cost performance.

In Nigeria, studies such as Babalola et al. (2015), Olubunmi and Ayo (2013), Ahmadu et al, (2013), Ogunsanmi (2013), Ishaya and Adogbo (2013) have examined and ranked the factors that are responsible for the performance of construction projects. However following the present Nigerian government's decision to transform sectors of the Nigerian economy, educational, commercial, health care and other several categories of building construction are anticipated to be on the increase. It will thus be useful if factors impacting construction cost can be assess across the different Universal Basic Educational building projects, in order to provide a basis for developing cost performance models that can be used for these projects. This study is therefore aimed at assessing the extent of impact of project contributory factors on cost performance of Universal Basic Educational building projects.

### **Factors impacting cost performance of construction projects**

From literature, it was observed that there is no consensus on the identification of plethora of factors which impact construction cost performance of building projects, basically because researches have widely viewed the subject from diverse perspective to define or determine the performance of construction projects. Amongst several research works which have been conducted to identify project contributory factors (procurement and non-procurement related factors) on project performance dimensions include:

The study conducted by Omran et al (2012) to investigate project performance in Sudan construction industry: A case study. The result found out that project availability of time, the size and complexity of projects, the type of project and duration of project, communication among project participants and overall managerial action, adequacy of design and specification, consultants commitment to ensure construction work according to specification, consultant cooperation to solve problems, consultants involvement to monitor the project progress, client ability to brief the project objectives, the size of client's organization and client's ability to make decision, client's interference during construction, the economic environment, political, social, skillful workers, quality control of materials, enough supply of materials, procurement method, tendering method, project team leader experience, planning effort, budget progress monitoring. The result of a similar study by Saraf (2013) of India construction projects which was aimed to investigate factors affecting performance of construction project. The survey findings indicate that the most important factors affecting project performance are: improper planning, improper designing, site management, decision making, methods,

shortage of labor and technical personnel, quality and shortage of materials, construction mistakes and defective work and productivity.

Eriksson and Vennstrom (2012) carried out a similar study to investigate the Effects of procurement on project performance. The result found that Cooperative procurement procedures of joint specification, limited bid invitation, soft evaluation parameters, joint sub-contractor selection, incentives, collaborative tools, contractor self-control and collaboration on project all have various effects on project performance. these factors according to Erickson and Westerberg (2012) shows how various procurement precedence the different procurement related factors at the design, bid invitation, bid evaluation and sub – contracting selection stages, compensation factors that can have various influences on project performance affect different aspects of project performance.

Nyangwara and Datche (2015) in Kenya supported that the most important factors agreed by the owners, consultants and contractors were: average delay because of closures and materials shortage; availability of resources as planned through project duration; leadership skills for project manager; escalation of material prices; availability of personals with high experience and qualification; and quality of equipment and raw materials in project. It was concluded that projects were delayed and the actual cost of projects was more than the estimated cost because of coastal region of Kenya political conditions and delayed payments which results to unavailability of materials.

Study by Mathonsi and Thawal (2012) also carried out a similar study in South Africa. The result revealed factors such as internal factors (project and client characteristics) and external factors (market competition, information technology, regulatory environment, natural causes and globalization) influence of the project life cycle, expedited project delivery; time, quality and price certainty. Dissanayaka and Kumaraswamy (2012) concluded that significant factors through quantitative models developed that, time over- run levels were mainly governed by non-procurement related factors( project characteristics and client/client representative characteristics while cost over- run levels were significantly influence by both procurement and non- procurement related factors (contractual payment modalities and project characteristics and client/client representative characteristic).

In Nigeria, Odediran and Windapo (2013) conducted a study on a systematic review of factors influencing the cost performance of building projects. The study highlighted fifteen (15) significant factors which include: additional works, material price fluctuation, variation order, project planning, monitoring and design accuracy. Cost estimated method. Others include design and construction errors, financial/cost planning, labour cost and requirements, poor site conditions, poor financial/ cost control and monitoring, poor materials and equipment procurement strategies, market conditions/ indices and contract documentation and administration.

The study conducted by Ogunsami (2013b) on the Effects of procurement related factors on construction project performance in Nigeria, shows that variation order factors strongly affect project performance causing time, cost overruns. Rashid et al. (2006) also conducted a similar study to investigate the Effect of procurement

systems on the performance of construction projects. The result shows that the different procurement systems allocation of responsibilities, activities sequencing, process and procedure and organizational approach have invariably affected the project performance.

## **RESEARCH METHODS**

The research adopted a conceptual framework of the independent dominant variables and dependent variable that shows the relationship of the extent of impact of Procurement Related Contributory Factors (PRC) and Procurement Related Contributory Factors (NPRC) on cost performance of building projects is proposed. The research evaluation of NPRC and PRC extent of impact on cost performance will be analyzed conclusively. The target population of the study comprised of two categories, first category are State Universal Basic Education Board (SUBEB) construction professionals in SUBEB and Government Agencies who have handled SUBEB building projects across the twenty three Local Government Areas (LGAs) in Kaduna State. The second category is completed building projects undertaken in the LGAs by SUBEB, Kaduna State.

SUBEB sponsored projects within the last few years (2014 -2018) in lower basic schools of learning of the 23 LGAs in Kaduna State. Preliminary investigations shows that SUBEB is active in these schools. Hence schools where SUBEB is not active are not included in the study. One hundred and twenty of such projects were identified from the twenty three LGAs and constitute the research population. Purposive sampling selection of well reputable and experienced construction professionals and completed building projects were made within the study area. The research adopted a quantitative, survey approach and primary data were collected by means of 120 questionnaires based on the 120 focal projects across LGAs of interest, 105 returned, 7 dropped and 98 valid for analysis. The questionnaires were administered to the informants (Quantity surveyors, Architects, Engineers, builders) in State Universal Basic Education Board (SUBEB) and Government Agencies who have handled SUBEB building projects across the twenty three Local Government Areas (LGAs) in Kaduna State.

A questionnaire on a 5 point Likert scale: where 1 stands for very low impact and 5 signifies very high impact was employed to establish the perception of the respondents on the extent to which 59 projects contributory factors of the 2 major NPRC and PRC factors with thirty nine (39) NPRC sub factors and PRC twenty (20) sub factors respectively.

The use of tables was employed in this research for data presentation. Mean score was used to analyzed the various project contributory factors (NPRC and PRC) likely to impact on building projects cost performance. The analysis was done using Statistical Package for Social Sciences (SPSS) version 25 software. The data sourced from the response of the respondents were analyzed and mean score were obtained using arithmetic mean and ranking method of the statistical analysis. The results were ranked and conclusions were deduced.

Further analysis was conducted to provide insight into the Conformity test of mean responds of extent to which NPRC factors impact on cost and time of the focal

projects using one sampled t- test. This is to test the mean responds of extent to which the NPRC and PRC factors impact on cost and time of the construction projects using mid-point as test score (2.5). Hypothesis: Ho: there is no significant differences between the mean responses of NPRC factors on cost of construction projects and mid-point and H1: there is significant differences between the mean responses of NPRC factors on cost of construction projects and mid-point. Level of significances:  $\alpha = 5\% = 0.05$ . Decision criteria: reject Ho, if probability value (p value) is  $< 0.05$  as shown in table 3 and table 5 below.

## RESULTS AND DISCUSSIONS

**Table 1: Respondents and projects profile**

	Category	Frequency	Percentage
i	Years of working experience		
	1- 5years	8	19.5
	6-10years	10	24.4
	11-15years	16	39.0
	16-above	7	17.1
	Total	41	100.0
ii	Respondents position in the organization		
	Senior management level	8	19.5
	Middle management level	22	53.7
	Lower management level	11	26.8
	Total	41	100.0
iii	Project executed within the research scope		
	1- 10	13	13.27
	11-20	17	17.35
	21- 30	22	22.45
	31- 40	30	30.61
	>40	16	16.32
	Total	98	100.0

Source: Field Survey, 2018

Table 1 ( i - iii) above shows that 41 professionals that responded to the questionnaire are from the meddle management level representing 53,7% with 11 – 15 years of working experience( 39%) and have executed 31 – 40 number of projects, representing 30.61% of the 98 projects used within the research scope.

For the purpose of this research, the perception on extent to which NPRC and PRC contributory factors impact cost performance of building projects were measured using a five Likert-type scale. Fifty nine (59) indicators of the two major groups (NPRC and PRC) were presented to construction professionals in the form of statement items. Given their experience on the focal projects, the respondents were requested to rate the extent of perception to which they agree with the statements. Table 2 and 3 shows the mean score for each of the fifty nine indicators of NPRC and PRC and their ranks.

**Table 2: Summary of extent to which NPRC factors impact on cost performance of building projects**

NPRC factors	Mean score	Std Dev.	Rank
Client financial stature	4.50	.707	1
Project size and complexities	4.47	.613	2
Project team collaborations	4.45	1.006	3
Project cost/ duration	4.35	.775	4
Client project budget/action plan	4.29	.760	5
Design team experience	4.20	1.031	6
Availability of skilled workers in the locality	4.22	1.021	7
Adequacy of design and specifications	4.14	1.055	8
Client rational/ need assessment	4.06	1.024	9
Accuracy of design details to contractor	4.02	1.065	10
Contractor's experience	3.98	.718	11
Quality control of materials	3.96	.903	12
Client's ability to brief the project objectives	3.94	1.003	13
Political considerations/interferences	3.93	1.372	14
Contractor involvement in decision making	3.92	1.012	15
Consultant's commitment to ensure construction work according to specifications	3.86	1.035	16
Project site condition difficulties	3.84	.960	17
Nature of Project	3.78	1.099	18
Overall project team common goals and strategies	3.80	1.015	19
Availability/ enough supply of quality materials in the locality	3.80	1.218	20
Consultant's involvement to monitor the project progress	3.73	1.215	21
Contractor's involvement/ control of subcontractors	3.69	1.078	22
Economic activity levels	3.61	.970	23
Strength of contractor workforce	3.43	1.055	24
Contractor information flow	3.43	1.149	25
Client's ability to make decision	3.39	1.448	26
Client in-house capability	3.39	1.090	27
Material/labour site management difficulties	3.36	1.188	28
Client's experience	3.24	1.540	29
Client overall project management	3.24	1.500	30
Contractor financial status	3.12	.987	31
physical climate and force majeure	3.07	1.379	32
Design team leadership skills	2.98	1.457	33
Consultant cooperation to solve problem	2.38	1.162	34
Changes in designs	2.31	1.134	35
Mistakes/delays in design documents	2.31	1.134	36
Material/ labour rate approval	2.29	1.377	37
Social and cultural conditions in the area	2.19	1.164	38
Project team feedback capabilities	2.10	1.540	39

Table 2 Revealed that 39 non procurement related factors were considered. 33 non procurement related factors are impactful on project cost performance. The topmost of non-procurement related factors is client financial stature (Mean Scores =4.50). The second factors of non-procurement related are project size complexities (Mean Scores = 4.47). The third factor is project team collaboration (Mean Scores = 4.45). The three least mean scores of non-procurement related factors are feedback capabilities (Mean Score= 2.10); social and cultural condition in the area (Mean Scores: 2.19) material rate approvals (Mean Scores: 2.29) the lowest factors are dropped because these factors doesn't contribute to the

performance of the buildings/construction in these areas in terms of cost. This was however obvious because the cost of the SUBEB buildings depend on the financial stature of the client (SUBEB/ UBEC sponsored).

**Table 3. One-sample test of NPRC factors impacts on the cost of projects**

	Test Value = 2.5				95% Confidence Interval of the Difference	
	T	d f	Sig. (2-tailed)	Mean Difference	Lower	Upper
	NPRC factors impact on construction projects	9.689	38	.000	1.05821	.8371

Table 3 shows that since p value =0.000 is < 0.05, we reject Ho and conclude that there is significance differences in the mean responses of NPRC factors impact on the cost of construction projects and mid points. This means the respondents agrees NPRC factors has impacts on the cost of construction projects.

**Table 4: Summary of extent to which PRC factors impact on cost performance of building projects.**

PRC factors	Mean scores	Std Dev.	Rank
Procurement method type	4.08	.949	1
Project responsibilities and contractual obligations to people and organizations	4.08	.949	2
Participation of many decision makers	4.06	.771	3
Payment arrangement motivations to contractor	3.90	1.223	4
Project work co-ordination	3.80	.930	5
Contract award price and time	3.69	1.277	6
Project structure and elements identification	3.65	.982	7
Contract documents coherent with the existing legal framework.	3.65	1.277	8
Appropriate project processes and procedure	3.53	.933	9
Legal obligations, roles and responsibilities between parties	3.46	1.037	10
Contract conditions type	3.43	1.035	11
Payments in an efficient manner by the client	3.29	1.149	12
Contract documents reduce uncertainties, disputes and interference	3.24	1.370	13
Selection method type	3.19	.960	14
Variation orders	3.06	1.225	15
Amended contract conditions clauses to client's advantage sue for the project.	2.90	1.640	16
Payments in an economic manner by the client	2.78	1.523	17
Early consideration of selection method of the project	2.69	1.395	18
Consideration of a wide range of necessary and sufficient decision criteria	2.53	1.151	19
Type of Payment arrangement	2.37	1.179	20

Table 4 revealed 20 procurement related factors that are considered. Nineteen factors are impactful to the building performance in terms of cost. The project procurement method used and project responsibilities, contractual obligations to people and organizations (Mean Scores = 4.08 each). The second is participation of many decision makers (Mean Score = 4.06). The third factor is payment arrangement motivations to contractor (Mean Score = 3.90). The three lowest procurement related factors are type of payment arrangement (Mean score = 2.37).

The two other factors under procurement related which are less impactful are consideration wide range of decision criteria (mean score = 2.53) and early considerations of selection method of the project (mean score = 2.69). This was obvious from SUBEB organization visit, interviews on building budget and action plans and one can deduced that project payment arrangement, wide range of decision criteria and early considerations of selection method does not really have much impact on SUBEB building construction in terms of cost.

**Table 5 One Sample Test of PRC factors impacts on the cost of projects**

	Test Value = 2.5					
	T	df	Sig. (2-tailed)	Mean Difference	95% Confidence Interval of the Difference	
					Lower	Upper
PRC factors impact the cost of construction projects	7.475	19	.000	.86900	.6257	1.1123

From Table 5 above the Conformity test of mean responds of extent to which PRC factors impact on cost of the focal projects using one sampled t- test, revealed that p value =0.000 is < 0.05, we reject Ho and conclude that there is significance differences in the mean responses of PRC factors impact on the cost of construction projects and mid points. This means the respondents agrees PRC factors has impacts on the cost of construction project.

**Discussion of findings**

Based on the findings, the levels of thirty three of the identified NPRC were found to fall between moderate impact and very high impact with weighted mean values between 2.98 - 4.50; this means that majority NPRC factors impact building project time performance except Consultant cooperation to solve problem , Changes in designs, Mistakes/delays in design documents , Material/ labour rate approval, Social and cultural conditions in the area and Project team feedback capabilities all with mean scores below 2.38. Nineteen of the identified PRC levels were found to fall between moderate impacts and very high with weighted mean values between 2.53 – 4.08; this also means that all PRC factors impact time performance of building project except type of payment arrangement with mean scores below 2.37.

In addition, the results concerning the impact of NPRC factors on cost performance of building projects shows that, NPRC factors have high impact on cost performance of the focal building projects. The findings from table 2 shows client financial stature, project size / complexities and project team collaborations as the leading NPRC factors that impact on cost performance of the focal building projects. These findings was similar with the study concluded by Babalola and Ojo (2016) in Nigeria that Client’s experience whether he is sophisticated or specialized; complexity of project; motivating skill of the project team leader; project team leader experience among others. PRC findings from table 3 in this research shows Procurement method type, Project responsibilities and contractual obligations to people and organizations, Participation of many decision makers and payment

arrangement motivations to contractor. This finding is similar to the study by Rashid et al. (2006) that revealed the different procurement systems allocation of responsibilities, activities sequencing, process and procedure and organizational approach have invariably affected the project performance. This finding was slightly different from Ibrahim et al (2014) that reveals late honoring of payment certificate, too many variations, and technical incompetence were the most severe factors affecting performance.

Further analysis was conducted to provide insight into the Conformity test of mean responds of extent to which NPRC factors impact on cost and time of the focal projects using one sampled t- test. This is to test the mean responds of extent to which the NPRC and PRC factors impact on cost and time of the construction projects using mid-point as test score (2.5). Hypothesis: Ho: there is no significant differences between the mean responses of NPRC factors on cost of construction projects and mid-point and H1: there is significant differences between the mean responses of NPRC factors on cost of construction projects and mid-point. Level of significances:  $\alpha = 5\% = 0.05$ . Decision criteria: reject Ho, if probability value (p value) is  $< 0.05$  as shown in table 3 and 5 below.

The result from table 3 and table 5 conformity test of mean responds of extent to which NPRC and PRC factors impact on cost of the focal projects using one sampled t- test, revealed that NPRC (p value =0.000 is  $< 0.05$ ) and PRC (p value =0.000 is  $< 0.05$ ), we therefore, reject Ho and conclude that there is significance differences in the mean responses of NPRC and PRC factors extent of impact on the cost of SUBEB building construction projects and mid points. This means the respondents agrees PRC factors has impacts on the cost of construction project. This means the respondents agrees that both NPRC and PRC factors have impacts on the cost of construction projects.

## **CONCLUSION/ RECOMMENDATION**

In order to examine the extent of the impact of procurement related contributory factors and non-procurement related factors on the cost performance of building projects. The study affirmed that, project contributory factors do exist and can impact cost performance at varying extent. This is because cost performance of building projects is dependent on a number of project contributory factors (Procurement Related Contributory factors (PRC) and Non-Procurement Related Factors (NPRC) among others, though majority of these factors showed high impact on cost performance of building projects, but the very high impact of NPRC are Client financial stature (mean = 4.50), Project size/complexities (mean = 4.47) and Project team collaborations (mean = 4.45). While the very high impact for PRC are procurement method type (mean =4.08), project responsibilities and contractual obligations to people/ organizations (mean = 4.08) and participation of many decision makers (mean = 4.06). A need for appropriate and adequate consideration of the very high impact identified NPRC and PRC factors should be develop and were recommended as the basis for SUBEB building construction projects in any scenario aimed at effective cost performance. This study therefore calls on SUBEB construction professionals and construction industry professionals in general to the knowledge of impact of NPRC and PRC factors on cost performance of building projects. This study recommended that NPRC and PRC



factors should be taken serious as these factors can be problems militating against effective cost performance of building projects. This is evident in the mean responds conformity one - sample t- test that demonstrated the respondents' agreements of both NPRC and PRC factors extent of impacts on the cost of building projects at different extent.

## REFERENCES

- Ahmadu, H. A., Ibrahim, Y. M. & Ibrahim, A. D. (2013) Periodization Of Factors Affecing Construction Time Of Building Projects In Nigeria, Proceedings Of The 1st Annual Research Conference (Anrecon) Of The Nigeria Istitute Of Quantity Surveyors, Pp 169 – 180.
- Babatunde, S. O., Opawole, A. I., & Ujaddughe, I. C. (2010).An Appraisal Of Project Procurement Methods in the Nigerian Construction Industry, Civil Engineering Dimension, Vol. 12(1), Pp 1-7.
- Babalola, H. I., Emmanuel, O. O., Lawal, A., & Elkanah, A. (2015). Factors Affecting the Performance of Public Construction Projects in Akure, Nigeria.International Journal of Civil Engineering, Estate Management, Vol (3)4, pp 57- 67.
- Babalola, H. I., & Ojo, O. J. (2016) an Investigation into Factors Affecting the Performance of Public Construction Projects in Ondo State, Southwestern, Nigeria, Department of Project Management Technology, Federal University of Technology Akure, Ondo State, Nigeria.
- Chartered Institute Of Building (CIOB) (2010). Procurement in the Construction Industry Englemere, Kings Ride, Ascot, Berkshire SL5 7TB, United Kingdom.
- Dissanayaka, S. M. (1998). Comparing Procurement and Non-Procurement Contributors to Project performance in Hong Kong construction industry. Retrieved from patmo cyber café on 6th may 2015.
- Dissanayaka, S. M., & Kumaraswamy, M. M. (1999) Comparing contributors to time and cost performance in building projects. Building and Environment, Vol. 34(1), pp31- 42.
- Dissanayaka, S. M., & Kumaraswamy, M. M. (2012) Evaluation of factors affecting time and cost Performance in Hong Kong building projects. Engineering Construction and Architectural Management, John Wiley & Sons online library, Inc. Vol. 6(3), pp287– 298.,
- Enshassi, A., Mohamed S., & Abushaban, S. (2009) Factors affecting the performance of Construction projects in the Gaza Strip, Journal of Civil Engineering and Management 15(3)DOI: 10.3846/1392-3730.2009.15.269-280
- Eriksson, P., & Westerberg, M. (2012). Effects of Procurement on Construction Project Performance, Retrieved on 25<sup>th</sup> June, (2015) from <[http://www.pure.itas/portal/files/3477530/Pocurement-related\\_success=factors\\_effect\\_on\\_project\\_performnce\\_submitted\\_IAMT.pdf](http://www.pure.itas/portal/files/3477530/Pocurement-related_success=factors_effect_on_project_performnce_submitted_IAMT.pdf).
- Eriksson, P., & Vennstrom, A. (2012), Effects of Procurement on Project Performance. Survey of Swedish Construction Clients. Retrieved on 25th June, (2015) from <[http://www.pure.itase/portal/files/3477530/Procurement\\_related\\_success=factors\\_effect\\_on\\_project\\_performance](http://www.pure.itase/portal/files/3477530/Procurement_related_success=factors_effect_on_project_performance)
- Idoro, G. I. (2012) Comparing Levels of use of Project Plans and Performance of Traditional Contract and Design-Build Construction Projects in Nigeria", Journal of Engineering, Design and Technology, Vol. 10 (1), Pp.7 – 33.

- Ishaya, G., & Adogbo, K. J. (2013) an appraisal of factors affecting the performance of construction projects in Nigeria, department of Quantity Surveying, Ahmadu Bello University, Zaria, Nigeria. Proceedings of the 1st Annual Research Conference (AnReCon) Nigeria Institute of Quantity Surveyors, pp 110- 119
- Mathonsi, M. D., & Thwala, W. D. (2012). Factors Influencing the Selection of Procurement Systems in the South African Construction Industry. *Africa Journal of Business Management*, Vol. 6(10), pp 3583-3594.
- Mohmoud, A. H. (2020) Factors Affecting Performance at the Iraq Construction Perfect Ministry of Construction Housing, Municipality and Public Works of Iraq as a case study, *Asian Journal of Civil Engineering* vol.21 pp 105-118.
- Nyangwara, P. O., & Datche, E. (2015) Factors Affecting the Performance of Construction Projects: A Survey of Construction Projects in the Coastal Region of Kenya, Jomo Kenyatta.
- Odediran, S. J., & Windapo, O. (2013) A Systematic Review of Factors Influencing the Cost Performance of Building Project sunnyodediran@yahoo.com
- Ogunsanmi, O. E. (2013a). Effects of Procurement Related Factors on Construction Project Performance in Nigeria. *Ethiopian journal of environmental studies and management*, Vol.6 (2)
- Ogunsanmi, O. E. (2013b) Comparisons of Performance of Traditional and Labour Only Procurement in Construction Projects In Nigeria, *DBA Africa Management*, Vol. 3 (2), Pp. 1-15.
- Olubunmi A. C., & Ayo, B. A. (2013) Cost and Time Performance of Construction Projects under The Due Process Reform in Nigeria Research Inveny: *International Journal of Engineering and Science* Vol.3 (6), PP 1-6, [Www.Researchinveny.Com](http://www.Researchinveny.Com)
- Omran, A., Abdalrahman, S., & Pakir, A. (2012) Project Performance in Sudan Construction Industry: A Case Study, School of Housing, Building and Planning, Universiti Sains Malaysia, Pulau Pinang, Malaysia, *Academic Research Journals (India)*, Volume1, pp.55-78 E-mail: naser\_elamroni@yahoo.co.uk).
- Omran, (2012). "Project Performance in Sudan Construction Industry". *Academic Research Journal*, Vol. (1), Pp. 55-78.
- Owolabi, J. D., Lekan A. M., Oloke C. O., Olusanya O, Tunji- Olayeni P, Owolabi D, Peter, J., & Omuh, I. (2014) Causes and Effect of Delay on Project Construction Delivery time, Building Technology Department. Covenant University. *International Journal of Education and Research*, Vol. 2 (4), pp 197 - 207
- Saraf, D. D. (2013) Study of Factors Affecting Performance of Construction Projects, College of Engineering & Management, Badnera, Amravati, Maharashtra, India, *International Journal of Science and Research (IJSR)*, Vol. 4(5). [www.ijsr.net](http://www.ijsr.net)
- Soewin, E., & Chinda, T. (2018) Factor Affecting Construction Performances ; Exploratory Factors Analysis, IOP publishing ltd , IOP Conference Series; *Earth and Environmental Science* vol. 140 , 4th International Conference on Civil and Environmental Engineering for Sustainability (ICONCEES 2017), Hangkaw Malaysia, PP 4-5.



# THE POTENTIAL ROLE OF GREEN INFRASTRUCTURE ON MENTAL HEALTH AND WELL-BEING: THE COVID-19 PANDEMIC EXPERIENCE

Adedotun Ayodele Dipeolu<sup>1</sup> and Akintunde Olaniyi Onamade<sup>2</sup>

<sup>1</sup>*Department of Architecture, College of Engineering and Environmental Studies, Olabisi Onabanjo University, Ogun State, Nigeria*

<sup>2</sup>*Department of Architecture, Caleb University, Imota-Lagos State, Nigeria*

Urban Green Infrastructure (GI) is an essential element in the urban environment, providing multiple ecosystem services that could help combat many urban environmental challenges and improve physical and mental health for city dwellers. Although, rapid changes in urban growth rates has put these facilities under intense pressure in cities worldwide, the present challenges of COVID-19 pandemic have declared a need to harness the potentials of available strategies that can efficiently manage the sustenance of life and the living conditions of human in the built environment. This study examined the influence of GI on mental health and wellbeing of residents affected by COVID-19 lockdowns and restriction to mobility in selected neighbourhoods in Abeokta, Ogun State. A multi-stage sampling technique was used to select 162 residents who participated in a questionnaire survey conducted in the study area. The results of the descriptive statistics reveal that 78.4% of the residents are aware of the COVID-19 and restriction to mobility. 44.4% of the participants visited GI sites within their neighborhood to ease the perceived mental stress of the lockdown, while 34.6% of the respondents confirmed that lockdown allowed them to spend more time with their family. Also, 40.7% of the respondents agreed that adequate provision of UGI facilities in their neighbourhood will enhance opportunity for recreation in case of future lockdowns. This implies that with appropriate government policies on expanding the planning and implementation of various UGI facilities and strategies both in public and private spaces, the effects on mental health and well-being of COVID-19 lockdowns and other similar crises can be sufficiently tackled among urban residents.

Keywords: COVID-19, ecosystems, environmental sustainability, green infrastructure, mental health

## INTRODUCTION

Globally, governments are working round the clock to invent strategies to reduce or prevent the spread of the COVID-19 following the declaration of a global pandemic by the World Health Organization in the first quarte of year 2020. Part

<sup>1</sup> dipeolu.adedotun@oouagoiwoye.edu.ng; archidot2002@yahoo.com

<sup>2</sup> onamadeasso@yahoo.com

of the immediate measures to curb the pandemic include stepwise restrictions in individual mobility and public life with total lockdown of cities in some part of the world (Hanzl, 2020; Ugolini et al, 2020). Apart from these, the quest for environmental strategies which facilitate healthier lifestyles while impeding the spread of the epidemic has recently gained fresh recognition. Studies conducted during the ongoing pandemic have shown how important urban green infrastructure (GI) is for the physical, mental health and wellbeing of urban residents. Other recent studies have also shown that green infrastructure offers a wide range of ecosystem functions and services essential to human health, wellbeing and urban sustainability (O'Brien et al, 2017; Staddon et al, 2018). These aspects of GI are of particular relevance under environmental and health crises such as the current COVID-19 pandemic.

Urban Green Infrastructure (GI) includes strategically planned and delivered networks of multi-functional green space and facilities that contribute to the protection of natural habitats, species diversity and other environmental features designed and managed with the aim of delivering ecological services and quality of life benefits to the built environment (Wolch et al, 2014; Mexia et al, 2018; Dipeolu, Ibem & Fadamiro, 2021). Among other benefits, GI strengthens the quality of life in the built environment (Venter et al, 2020; Sanesi et al, 2011), as it provide avenue to reduce stress and increase motivation (Zuniga-Teran et al, 2020; Kim & Song 2019), enhance social cohesion (Dipeolu, Ibem & Fadamiro, 2020; Zijlema et al, 2017), encourage physical activity (Hunter et al, 2015), improve physical health (Van den Bosch & Sang, 2017) and even promote a person's wellbeing and mental health (Nath et al, 2018; Zhang et al, 2017).

Most importantly, GI has ability for city resilience. Urban resilience has been defined as the 'ability of an urban system and all its constituents ( socio, economic and environmental) networks across temporal and spatial scales to maintain or rapidly return to desired functions in the face of any form of tilting or disturbance, to adapt to change, and to quickly transform systems that limit current or future adaptive capacity (Meerow et al, 2016). Thus, a resilient city is one that anticipates, forecasts, plans and acts to prepare for and respond to unexpected turbulence. Urban forests and parks for example, provide cooling benefits during hot summer (Norton et al, 2015), thus reducing the effect of urban heat island and heat related diseases or infections. Street tree canopies are suggested as a solution for shading pedestrian space, with broadleaf tree species being most effective in increasing thermal comfort (Pamukcu-Albers et al, 2021) especially when there is need to engage in trekking.

Like several other nations, the Nigerian government in a bid to curtail the spread of the pandemic, imposed lockdowns and restriction to mobility in every states of the federation. This emergency decision took residents by surprise as they were mostly less prepared for the pandemic just like many other people around the globe. This forced residents to devise various strategies to cope with the situation while the imposed lockdowns last. In view of the foregoing and the need for human race to find a solution and survive the numerous challenges of COVID-19 pandemic, this study examined the impacts of GI on mental health and wellbeing of people affected by COVID-19 lockdowns and restriction to mobility in selected

neighbourhoods in Abeokuta, Ogun State. The specific objectives of this study are to:

- i. assess the effectiveness of awareness about COVID-19 and the coping strategies by residents during the lockdowns in the study area;
- ii. examine the perceived effects of COVID-19 lockdowns on mental health and well-being of residents in Abeokuta Ogun State; and
- iii. investigate the perceived role of GI facilities during the COVID-19 lockdowns in Abeokuta, Ogun State.

This study makes contribution to knowledge by improving understanding of the specific role GI plays in promoting mental health and wellbeing during the compulsory lock down or stay at home period in many cities around the world. It also uncovers the strategies through which urban residents engaged in order to cope with the mental stress and maintenance of well-being during the COVID-19 pandemic saga. In this regard, the study informs urban designers, planners and managers on the way to strengthen the planning and implementation of GI facilities and strategies to improve good health among human populations which is vital in creating safe, long and sustainable urban life in African and other continents of the world.

## **LITERATURE REVIEW**

### **Effects of COVID-19 pandemic on human life and population**

The COVID-19 pandemic has been reported to forced entire countries into total lockdown, threatened citizens around the world, and ignited a rapid economy meltdown (Uchiyama & Kohsaka, 2020; Venter, Barton, Gundersen & Figari, 2020; Badejo, Ogunseye & Olanikanmi, 2020). National governments have requested that citizens adopt and adjust to the concept of the "new normal" lifestyle in order to adapt to the changes. Measure such as "work from home", lock down of religious houses, restriction on mass gathering, reduction in passengers on commercial vehicles and various forms of home quarantine were all put in place to avoid crowds in workplaces, religious houses, event centres and traffic (Honey-Rosés et al, 2020; Uchiyama & Kohsaka, 2020).

Most importantly, people who have potentially come into contact with the infection were asked to isolate themselves at home or in a dedicated quarantine facility in many countries. Owing to the lockdown of cities to control the spread of infection, access and use of green areas and other public spaces were been restricted. During lockdowns, the distances that could be travelled were restricted and public transport was reduced, meaning that people could only access green spaces if it was close to home. Their amenities and features also became important as residents sought out the greenest public spaces within their neighborhoods with most tree coverage to recreate or relax in order to tackle COVID-19 mobility restrictions (Pamukcu-Albers et al, 2020; Samuelsson et al, 2020). Existing studies (Ely & Pitman, 2014; Craik et al, 2015; Dipeolu et al, 2020) have shown that residents in neighbourhoods without or inadequate availability of GI facilities are likely to suffer more boredom environment and are also more likely to be willing to escape

from their neighbourhoods in order to gain access to nature in other neighbouring communities.

### **Planning green infrastructure to increase urban pandemic resilience**

Green infrastructure (GI) is an interconnected network of green spaces that conserves natural ecosystems values and functions and provides associated benefits to human populations (Benedict & McMahon, 2002). It consists of natural and semi-natural landscapes such as grasses, trees domestic gardens, informal parks, green walls, green roofs, open spaces, as well as water features of streams, wetlands found within residential neighbourhoods in urban areas (Jennings et al, 2017; Kumar et al, 2019). Ely and Pitman (2014) observed that GI exists in various physical forms such as public parks and gardens, greenways, street verges and open space pockets in residential and other streets, sports and recreational facilities, private and semi-private gardens, green roofs and walls, squares and plazas, natural green space, utility areas, and agricultural and other productive land.

Studies on the role of GI in addressing the challenges induced by the COVID-19 pandemic is just emerging (Uchiyama & Kohsaka, 2020). Generally, findings of these studies have shown how important urban nature is for the mental health and wellbeing of urban residents. The importance of availability of GI in urban neighbourhoods became very noticeable especially during the imposed lockdowns and restrictions by various governments in many nations as an attempt to curtail the spread of the virus. Hanzl (2020) reported that during the lockdown human mobility patterns in most part of the world was significantly altered as there were limited access to the green spaces and recreation areas very far from residents neighbourhoods. Thus, the imposed lockdowns brought additional mental stress to many residents who were used to the hustling and bustling of the city life. While the containment measures contributed to lowering the virus outbreak and the number of positive cases, they strongly limited personal freedom and deprived people of their liberty to visit their preferred green spaces (Ugolini et al, 2020).

However, studies of Ugolini et al. (2020) and those of Samuelsson et al. (2020) have argued that urban nature can help reduce stress momentarily and provide relaxation during long periods of social distancing and household confinement. Other studies in congruent to this submission include the study by Venter et al. (2020) which showed that pedestrian activity in Oslo increased in city parks, peri-urban forests, and protected areas during the COVID-19 pandemic. Previous studies also submitted that accessibility and usability of green areas are important aspects for improving the quality of life in urban settlements for a variety of reasons related to wellbeing (sports or physical exercise), observing nature especially when areas are rich in biodiversity and socializing activities (Kumar et al, 2019; Quatrini et al, 2019; Zijlema et al, 2017; Jennings et al, 2017;)

## **METHODS**

### **Study area and research population**

Abeokuta the study area, lies on latitude 7° 8' N and longitude 3° 25' E coordinates. It is a fast-growing city in the Southwest Nigeria and capital of Ogun State. It is a nodal urban centre situated about 81 kilometers south-west of Ibadan, the capital



For the sample size, previous studies have suggested that sampling frame and sampling sizes are better determined in proportion to the population of the study area. Also, scientific selection of small sample from larger population gives a true representation of the study area and guaranteed accuracy (Okoko, 2000; Babbie, 1998). Neuman (1991) opined that larger population permit smaller sampling ratio. He asserted that as the population size grow, the returns in accuracy for sample size shrinks. Therefore, to get a reasonable sample size for this study, a total of 200 questionnaires were given out for the survey.

The data were obtained from the participants with the help of pretested structured questionnaire designed by the researchers. The review of literature was helpful in the identification of variables investigated. The questionnaire was structured into different sections based on the specific issues investigated. Specifically, the first section was used in extracting data on the following variables 1) the participants' demographic characteristics 2) awareness, coping strategies and perceived effects of the COVID-19 lockdown in the study area 3) the Perceived role of green infrastructure among residents of the study area during the COVID-19 lockdowns.

### **Data collection**

The data presented in this paper were sourced from authors field-work in a survey conducted between the months of November and December 2020. Participants were household heads or adult representative who can and were willing to provide the needed information. Part of the data collection process involved visits by the authors to the Ogun State office of the National Population Commission (NPC) to obtain the lists of Enumeration Areas (EAs) in the two LGAs involved in the study. These documents helped in the identification of 4 EAs in each of the two LGAs making 8 EAs in all.

The main survey comprised of the administration and retrieval of copies of the questionnaire from the residents in the selected neighbourhoods. The selection of the participants in the survey was based on the sampling intervals (n) determined by dividing the number of houses in each of the 8 enumeration areas (EAs) identified by the determined sample size for each of the EAs. The household heads were then systematically sampled from the list of numbered houses in each EA until the required household heads allocated to each of the EAs was achieved. The first (1st) house at the nodal point within each EA was chosen, subsequent selections were systematically done based on the predetermined sampling interval (n) for each of the two LGAs sampled. One copy of the questionnaire was administered by hand to every consenting household head or adult representative found in the housing units when the survey was carried out. Out of the 200 copies of the questionnaire administered by the researchers, 162 of them were retrieved and correctly filled giving a response rate of 81.0 %.

## **ANALYSIS AND RESULTS**

### **Socio- demographic distributions of Respondents**

There were 162 respondents, 59.3% were male while 40.7% were female (Table 1). Nearly half of the participants (48.8%) were aged 30-49 years old while only 13.6% of the participants were 50 years or older. Participants were mostly married (56.8%) living in household comprising of two-four (44.4%) and more than four (38.3%)



persons per household. Also, from Table 1 more than half of the participants (53.1%) had tertiary education while only few (4.3%) have no formal education. Some of the participants (38.9%) were management staff/business owners, while 30.2% were junior staff and 19.8% were senior staff in either civil services or private companies.

**Table I: Socio-Demographic distributions of respondents N= 162**

Variables	Frequency	Percentage (%)
Sex		
Male	96	59.3
Female	66	40.7
Current age		
<30	42	25.9
30-49	79	48.8
>=50	22	13.6
Not Reported	19	11.7
Marital Status		
Never Married (Single)	59	36.4
Married	92	56.8
Previously Married	10	6.2
Not Reported	1	0.6
Household Size		
One person	16	9.9
Two-four Persons	72	44.4
More than Four Person	62	38.3
Not Reported	12	7.4
Religious Affiliations		
Christianity	84	51.8
Islam	67	41.4
Others	10	6.2
Not Reported	1	0.6
Highest Educational Qualification		
No Formal Education	7	4.3
Primary Education	14	8.6
Secondary / Technical Education	52	32.1
Tertiary Education	86	53.1
Not Reported	3	1.9
Profession		
Unemployed	18	11.1
Self employed	64	39.5
Private/Public employee	52	32.1
Students and Others	28	17.3
Rank in Occupation / Income level		
Junior Staff	49	30.2
Senior Staff	32	19.8
Management staff/ Business owners	63	38.9
Not Reported	18	11.1

### **Awareness and coping strategies by residents during the COVID-19 lockdown**

Awareness level about the COVID-19 related lockdowns was sought from the respondents. Table 2 indicated that 78.4% of the respondents were aware while only 7.4% claimed not aware of the lockdown periods. 41.9% were aware through the radio, 30.2% through the television, 14.2% through either friend, relatives or neighbours and 11.1% through government officials. Due to this level of awareness, more than half (53.2%) of the participants did not receive visitors in their houses while 38.2% still received visitors during the lockdown period.

When the participants were asked how they coped with the emergency lockdown and restriction to mobility, 50% responded that they did not visit anywhere outside their neighbourhood while 34.6% reported otherwise. However, 77.8% reported that they visited places within their immediate neighbourhood during the lockdown to ease boredomness while 19.1% reported no visitation even within the neighbourhood. Majority (44.4%) of the participants visited neighbourhood GI sites, 27.2% visited their friend's houses, 12.4% visited religious houses/places of worship while only 11.1% visited other places to ease the boredomness of the lockdown.

On participants reasons for visiting places within their neighbourhood during the COVID-19 lockdowns, 51.9% asserted this to relaxation and recreational purposes, 15.4% and 11.7% said it is for religious and educational purposes respectively while 17.9% attributed it to other reasons. Rating the lockdown compliance in the study area, 28.4% of the participants rated compliance to be very good, while 38.9% and 24.1% of the participants rated compliance to the lockdown to be good and fair respectively in the study area.

### **Perceived effects of COVID-19 lockdowns on mental health and well-being of residents**

The study also assessed both the negative and positive impacts of the deployed COVID-19 lockdown measures on the mental health and well-being of the participants. The greatest negative impact from Table 2 was mental stress from boredomness (34.6%). Others that are of significance were low business patronage (21.6%), poverty/increased debts due to no job (14.8%), loss of job (14.2%), spending less time with friends (8.0%), and domestic violence with spouse (6.2%).

Despite the negative impacts, respondents have also perceived the lockdown measures from a positive angle. A larger proportion (34.6%) of the respondents confirmed that lockdown allowed them to spend more time with their family, 25.9% learned to do regular physical exercises and recreate, 20.4% engaged in new business, 16.1% learned to cope with available resources, while 1.8% learnt to prepare for future global disasters (Table 2).

**Table 2: Awareness, coping strategies and perceived effects of the COVID-19 lockdown**

Variables	Frequency	Percentage (%)
Awareness of lockdown in your neighbourhood		
Yes	127	78.4
No	12	7.4
Not Reported	23	14.2
Any visitor during the lockdown		
Yes	62	38.2
No	86	53.2
Not Reported	14	8.6
Did you visit anywhere outside your neighbourhood during the lockdown to ease boredomness?		
Yes	56	34.6
No	81	50.0
Not Reported	25	15.4
Did you visit anywhere within your neighbourhood during the lockdown to ease boredomness?		
Yes	126	77.8
No	31	19.1
Not Reported	5	3.1
Where did you mostly visit in your neighbourhood during the lockdown to ease boredomness		
My friends' houses	44	27.2
Neighbourhood green infrastructure sites	72	44.4
Religious houses/places of worship	20	12.4
Others	18	11.1
Medium of awareness of the lockdown		
Radio	68	41.9
Television	49	30.2
Friend/Relative/Neighbour	23	14.2
Government officials	18	11.1
Not Reported	4	2.6
Rating of lockdown compliance		
Very good	46	28.4
Good	63	38.9
Fair	39	24.1
Not reported	14	8.6
Which part of your building environment did you spend a good number of hours during the lockdown period		
Indoor	54	33.3
Outdoor	103	63.6
Not Reported	5	3.1
What were the perceived negative effects of the COVID-19 lockdown on your mental health and well-being		
Low business patronages	35	21.6
Loss of jobs	23	14.2
Spent less time with friends	13	8.0
Mental stress form boredomness	56	34.6
Poverty/increased debts due to no job	24	14.8
Domestic violence with spouse	10	6.2
Not Reported	1	0.6
What were the perceived positive effects of the COVID-19 lockdown on your mental health and well-being		
Spending more time with the family	56	34.6
I learnt to do physical exercises and recreate regularly	42	25.9
Engaging in new business ideas	33	20.4
I learnt to cope with available resources	26	16.1
I learnt to prepare for future global disasters	3	1.8
Not Reported	2	1.2

### Perceived role of GI during the COVID-19 lockdowns

To ascertain if GI play any significant role during the COVID-19 lockdown periods, participants were asked about their level of agreement with some statements on perceived role of GI facilities.

**Table 3: Perceived effect of GI on the COVID-19 Lockdown**

Variable	Frequency	Percentage (%)
Green infrastructure (GI) facilities are available in my neighbourhood for relaxation purposes		
Strongly disagree	23	14.2
Disagree	44	27.3
Undecided	37	22.8
Agree	34	20.9
Strongly agree	24	14.8
You need to go outside this neighbourhood to get Recreational parks		
Strongly disagree	33	20.4
Disagree	35	21.6
Undecided	12	7.4
Agree	46	28.4
Strongly agree	36	22.2
Compare to any other solution, availability of GI facilities greatly helped people in my neighbourhood to cope with the compulsory lockdown		
Strongly disagree	21	13.0
Disagree	22	13.6
Undecided	14	8.6
Agree	54	33.3
Strongly agree	51	31.5
Visit to the neighbourhood GI helped me to cope with boredomness during the compulsory lockdown		
Strongly disagree	26	16.1
Disagree	18	11.1
Undecided	8	4.9
Agree	64	39.5
Strongly agree	46	28.4
I visited my neighbourhood GI more than usual during the compulsory COVID-19 lockdowns		
Strongly disagree	26	16.0
Disagree	15	9.3
Undecided	12	7.4
Agree	52	32.1
Strongly agree	57	35.2
Adequate provision of GI facilities in this neighbourhood will enhance more opportunity for recreation in case of future lockdowns		
Strongly disagree	19	11.7
Disagree	24	14.8
Undecided	9	5.6
Agree	44	27.2
Strongly agree	66	40.7

On availability of GI in the study area for recreational purposes, Table 3 revealed that 14.2% of the respondents strongly disagreed, 27.3% disagreed while 20.9% of the respondents agreed and 14.8% strongly agreed. Participants were also asked if visits to the neighbourhood GI helped them to cope with boredomness during the compulsory lockdowns. 16.1% of the respondents strongly disagreed, 11.1% disagreed while 39.5% agreed and 28.4% strongly agreed. When asked if visit to GI sites helped people in their neighbourhood to cope with the compulsory lockdowns better than any other solutions, 13.0% of the respondents strongly disagreed, 13.6% disagreed while 33.3% agreed and 31.5% strongly agreed with only 8.6% undecided on the matter.

Furthermore, in Table 3 the statement on whether residents visited neighbourhood GI more than usual during the COVID-19 lockdowns has 16.0% of the respondents strongly disagreed, 9.4% disagreed while 32.1% strongly agreed and 35.2% agreed. At the same time, the question on if adequate provision of GI facilities in their neighbourhood will enhance opportunity for recreation in case of future lockdowns has 11.7% of the respondents strongly disagreed, 14.8% disagreed while 27.2% respondents agreed and 40.7% also strongly agreed.

## **DISCUSSION**

This study investigated the influence of GI on mental health and wellbeing of residents affected by COVID-19 related lockdowns and restriction to mobility in selected neighbourhoods in Abeokuta, Ogun State. Based on the findings, a number of issues that relate to the research objectives formulated for the study have emerged and brought forward for further discussion. First, in addressing the first objective, which deals with the effectiveness of awareness about COVID-19 lockdowns and the coping strategies by residents during the period, our survey data indicate that although a good number of the residents were aware about the COVID-19 pandemic and the related lockdowns, still some residents allowed visitors in their houses despite the lockdown and restrictions to mobility. However, awareness of the lockdowns by residents was majorly through the radio and the television. This proved significantly the role played by the media in deepening awareness about the pandemic as supported by studies of Badejo et al. (2020) and Samuelsson et al. (2020).

On the coping strategy during the lockdown periods, residents visited their neighbours, religious house and other places of interest within their neighbourhood. However, majority of the participants visited neighbourhood GI sites for the purpose of recreation and relaxation. In fact, the participants in the survey were emphatic that they preferred more outdoor environment than staying indoor during the compulsory lockdown periods. Going by the evidence in the literature (Pamukcu-Albers et al, 2021; Ugolini et al, 2020), GI provides cities with the capacity to withstand epidemic or pandemic induced stresses. This role of green areas in providing needed adaptation services in times of such crises has been widely studied and demonstrated (e.g., Gill et al, 2007; Kazmierczak & Carter, 2010)

Secondly, regarding the perceived effects of COVID-19 lockdowns on mental health and well-being of residents in the study area, respondents perceived that

the lockdowns has both negative and positive effect on their mental health and well-being. Top among the negative effect is the mental stress from the boredomness of the lockdown. As reported in previous studies (e.g Brooks et al, 2020), at the stage one of the COVID-19 pandemic, implementation of stay-at-home orders was effective in "flattening the curve" and provided the much-needed time for healthcare systems to increase their capacity while reducing the number of peak cases during the initial wave of the pandemic. However, after few months, most studies (Brooks et al, 2020; Uchiyama & Kohsaka, 2020; Ugolini et al, 2020) reported negative psychological effects including post-traumatic stress symptoms, confusion, and anger.

On the other hand, the findings of this research also reveal that respondents have also perceived the lockdown measures from a positive angle despite the mental stress, larger proportion of the respondents discovered that lockdown allowed them to spend more time with their family and they also learnt to do regular physical exercises and recreate. Previous studies have asserted that GI enhances socialization and strong communal bonding (Dipeolu et al, 2020), improves sense of identification of neighbours (Kim & Song, 2019) as well as the care by neighbours for one another (Zhang et al, 2017) These are indeed some of the social and health benefits of GI identified by previous authors as having link to sense of community, mental health and well-being (see Stigsdotter et al, 2010; Wloch et al, 2014; Venta et al, 2020).

Lastly, as it relates to the perceived role of GI facilities during the COVID-19 lockdowns in the study area, our survey data also reveal that availability of GI for recreational purposes in the study area is presently not well pronounced. This is because nearly half of the study participants disagreed with availability of GI in their neighbourhood while the remaining half agreed that GI is available in the study area. This result suggests that although GI is available (as confirmed by authors 'reconnaissance survey) in the study area but the available quantity and quality is not well pronounced to receive consensus acceptance availability by the residents. Furthermore, a good number of the residents reported that GI helped them to cope with boredomness during the compulsory lockdowns. Again, respondents were emphatic that no other solution that helped people in their neighbourhood to cope with the compulsory lockdowns better than the visit to GI sites. This result further emphasized the recreational values of GI as ascertained in the literature. GI rendered services to that are crucial to the wellbeing of urban populations, in particular in terms of human health benefits, both physical and psychological (Venta et al., 2020; Ugolini et al, 2020; Kumar et al, 2019; Quatrini et al, 2019; Tzoulas et al, 2007). Also from the study, the residents visited neighbourhood GI sites more than usual during the COVID-19 and opined that if adequate attention is given to the provision of GI facilities in their neighbourhood, it will enhance opportunity for recreation in case of future lockdowns. Existing studies have already addressed the potential for urban nature to enhance resilience of urban populations during the pandemic (Pamukcu-Albers et al, 2021; Hanzl, 2020; Ugolini et al, 2020) to provide 'quality of life 'by increasing resilience of cities. Results from these studies supported quality of life and health outcomes when patients and their relatives have good access to nature. The magnitude of improved health was positively associated with access to nature, suggesting that green spaces facilitated healing, social distancing and indirectly mitigated the spread of

COVID-19. Thus, UGI can contribute to the social resilience of cities, by acting as refuge for urban residents during periods with high levels of stress (Pamukcu-Albers et al, 2021).

## **CONCLUSIONS AND RECOMMENDATIONS**

This study investigated influence of UGI on mental health and wellbeing of residents affected by COVID-19 related lockdowns and restriction to mobility in selected neighbourhoods in Abeokuta, Ogun State. Based on the findings, three conclusions were arrived at. The first conclusion is that good number of the participants in the survey were aware of the COVID-19 lockdowns and they were able to device visits to GI facilities in their neighbourhoods as strategy to cope with mental stress of the lockdown. The second conclusion is that in spite of the mental stress, larger proportion of the respondents discovered that the lockdown allowed them to spend more time with their family and they also learnt to do regular physical exercises and recreate within GI facilities. The last conclusion is that presence of GI within the study area enabled residents to visit neighbourhood GI sites more than usual during the COVID-19 lockdown periods and opined that if adequate attention is given to the provision of GI facilities in their neighbourhood, it will enhance opportunity for recreation in case of future lockdowns.

These findings from this study imply that GI contributes effectively in helping residents in urban neighbourhoods to quickly devised strategy to cope with the mental stress of the emergency COVID-19 lockdowns. Thus, there is need for adequate provision of GI facilities and the rate at which green areas are depleted in the neighbourhoods needs to be checked through preservation and conservation. In addition, access to parks and gardens in the neighbourhoods should be improved and emphasis should be on the provision and maintenance of adequate number of well-equipped and properly located GI that meets the needs of every segment of the society, including children.

Lastly, the research design adopted in this study suggests that the current study is not without limitations. Firstly, since the data were sourced mainly via the administration of questionnaire, the findings are limited to biases of the respondents in the survey. Secondly, the geographic coverage of the survey is limited to the selected neighbourhoods in the two Local Government Areas in Ogun State as a result, the findings cannot be generalised for the entire Ogun State. Therefore, future study is needed to include more neighbourhoods and other LGAs for more robust results.

## **REFERENCES**

- Babbie, E. (1998). *The Practice of Social Research*. New York, Wadsworth.
- Badejo, B. A., Ogunseye, N. O., & Olasunkanmi, O. G. (2020). Rural Women and the COVID-19 Pandemic in Ogun State, Nigeria: An Empirical Study. *African Journal of Governance and Development*, 9(1), 382-403.
- Benedict, M. A., & McMahon, E. T. (2002) Green Infrastructure: Smart Conservation For The 21st Century. *Renewable Resources Journal*, 20 (3), 12-17.

- Brooks, S. K., Webster, R. K., Smith, L. E., Woodland, L., Wessely, S., Greenberg, N. & Rubin, G. J. (2020) The psychological impact of quarantine and how to reduce it: rapid review of the evidence. *The Lancet*. 395 (10227), 912–920. doi:10.1016/S0140-6736(20)30460-8.
- Craik, J., Faggi, A., Miguel, S., & Vorraber, L. (2015). Why do People Use Parks and Plazas in Buenos Aires? Retrieved from <https://www.thenatureofcities.com/2015/03/09/why-do-people-use-parks-and-plazas-in-buenos-aires/> on April 6, 2020.
- Dipeolu, A. A. & Fadamiro, J. A. (2013). Roles of Green Infrastructure in sustainable development of Abeokuta city, Nigeria. *International Journal of Ecology & Environmental Studies*, Institute of Ecology and Environmental Studies, Obafemi Awolowo University, Ile-Ife, Nigeria. 1(1), 26-31.
- Dipeolu, A. A., Ibem, E. O., & Fadamiro, J. A. (2020) Influence of Green Infrastructure on Sense of Community in Residents of Lagos Metropolis, Nigeria. *Journal of Human Behaviour in the Social Environment*, 30 (6), 743-759. <https://doi.org/10.1080/10911359.2020.1740853>
- Dipeolu, A. A., Ibem, E. O. & Fadamiro, J. A. (2021) Determinants of residents 'preferences for Urban Green infrastructure in Nigeria: Evidence from Lagos Metropolis. *Urban Forestry & Urban Greening*, 57, 1-9. <https://doi.org/10.1016/j.ufug.2020.126931>.
- Ely, M. & Pitman, S. (2014) Green Infrastructure. Life support for human habitats: The compelling evidence for incorporating nature into urban environments. Botanic Gardens of Adelaide, Department of Environment, Water and Natural Resources, South Australia, Australia.
- Gill, S., Handley, J., Ennos, A. & Pauleit, S. (2007) Adapting cities for climate change: the role of the green infrastructure. *Built Environment*, 33 (1), 115–133.
- Hanzl, M. (2020) Urban forms and green infrastructure – the implications for public health during the COVID-19 pandemic. *Cities & Health*, DOI: 10.1080/23748834.2020.1791441
- Honey-Rosés, J., Anguelovski, I., Bohigas, J., Chireh, V., Daher, C., Konijnendijk, C., Litt, J., & Orellana, A. (2020) The impact of COVID-19 on public space: An early review of the emerging questions–design, perceptions and inequities. *Cities Health*, 2020, 1–17.
- Jennings, V., Baptiste, A. K., Jelks, N. O., & Skeete, R. (2017) Urban Green Space and the Pursuit of Health Equity in Parts of the United States. *International Journal of Environmental Research and Public Health*, 14, 1432-1449.
- Kazmierczak, A. & Carter, J. (2010) Adaptation to climate change using green and blue infrastructure. A database of case studies. University of Manchester, Manchester.
- Kim, D. & Song, S. (2019) The Multifunctional Benefits of Green Infrastructure in Community Development: An Analytical Review Based on 447 Cases. *Sustainability* 11, 3917-3934. doi:10.3390/su11143917.
- Kumar, P., Druckman, A., Gallagher, J., Gatersleben, B., Allison, S., Eisenman, T. S., Hoang, U., & Morawski, L. (2019) The nexus between air pollution, green infrastructure and human health. *Environment International* 133, 16-27. <https://doi.org/10.1016/j.envint.2019.105181>.
- Meerow, S., Newell, J. P., & Stults, M. (2016) Defining urban resilience: a review. *Landsc Urban Plann* 147, 38–49



- Mexia, T., Vieira, J., Príncipe, A., Anjosa, A., Silva, P., Lopes, N., & Branquinho C. (2018) Ecosystem services: Urban Parks under a Magnifying glass. *Journal of Environmental Research* 160, 469-478.
- Nath, T. K., Zhe Han, S. S., & Lechner, A. M. (2018) Urban green space and well-being in Kuala Lumpur, Malaysia. *Urban Forestry & Urban Greening* 36, 34–41. <https://doi.org/10.1016/j.ufug.2018.09.013>.
- Neuman, W. L. (1991). *Social Research Methods: Quantitative and qualitative approaches* (2nd Edition). Boston, London: Allyn and Bacon.
- Norton, B. A., Coutts, A. M., Livesley, S. J., Harris, R. J., Hunter, A. M., & Williams, N. S. G. (2015) Planning for cooler cities: a framework to prioritise green infrastructure to mitigate high temperatures in urban landscapes. *Landsc Urban Plann* 134, 127–138.
- O'Brien L., De Vreese, R., Kern, M., Sievänen, T., Stojanova, B., & Atmis, E. (2017). Cultural ecosystem benefits of urban and peri-urban GI across different European countries. *Urban For Urban Green*, 24, 236–248.
- Okoko, E. E. (2000). *Quantitative Techniques in Urban Analysis*. Kraft Books Limited, Ibadan.
- Pamukcu-Albers, P., Ugolini, F., La Rosa, D., Građinaru, S. R., Azevedo, J. C., & Wu, J. (2021) Building green infrastructure to enhance urban resilience to climate change and pandemics. *Landscape Ecol*, 36, 665–673 [https://doi.org/10.1007/s10980-021-01212-y\(0123456789](https://doi.org/10.1007/s10980-021-01212-y(0123456789)
- Quatrini, V., Tomao, A., Corona, P., Ferrari, B., Masini, E. & Agrimi, M. (2019) Is new always better than old? accessibility and usability of the urban green areas of the municipality of Rome. *Urban For Urban Green*, 37, 126–134.
- Samuelsson, K., Barthel, S., Colding, J., Macassa, G., & Giusti, M. (2020) Urban nature as a source of resilience during social distancing amidst the coronavirus pandemic. <https://doi.org/10.31219/osf.io/3wx5a>.
- Sanesi, G., Gallis, C., & Kasperidus, H. D. (2011) Urban forests and their ecosystem services in relation to human health. In: Nilsson, K., Sangster, M., Gallis, C., Hartig, T., De Vries, S., Seeland, K., Schipperijen, J. (Eds.), *Forests, Trees and Human Health*. Springer, New York, pp. 23–40.
- Solanke, M. O. (2016). *Socio-economic Characteristics of Urban Residents and Intra-urban Trip Generation: An illustration from Abeokuta, Ogun State, Nigeria*.
- Staddon, C., Ward, S., De Vito, L., Zuniga-Teran, A., Gerlak, A. K., Schoeman, Y., Hart, A., & Booth, G. (2018) Contributions of green infrastructure to enhancing urban resilience. *Environ Syst. Decis* 38, 330–338.
- Stigsdotter, U. K., Ekholm, O., Schipperijn, J., Toftager, M., Pamper-Jorgensen, F., & Randrup, T. B. (2010) Health promoting outdoor environments--associations between green space, and health, health-related quality of life and stress based on a Danish national representative survey. *Scand J Public Health*, 38 (4), 411-417.
- Tzoulas, K., Korpela, K., Venn, S., Yli-Pelkonen, V., Kaźmierczak, A., Jari Niemela, J., & James, P. (2007) Promoting ecosystem and human health in urban areas using Green Infrastructure: A literature review. *Journal of Landscape and Urban Planning*, 81, 167–178.
- Uchiyama, Y., & Kohsaka, R. (2020) Access and Use of Green Areas during the COVID-19 Pandemic: Green Infrastructure Management in the “New Normal”. *Sustainability*, 12, 11-19. doi:10.3390/su12239842.

- Ugolini, F., Massetti, L., Calaza-Martínez, P., Cariñanos, P., Dobbs, C., Ostoic, S. K., Marin, A., & Sanesi, G. (2020) Effects of the COVID-19 pandemic on the use and perceptions of urban green space: An international exploratory study. *Urban Forestry & Urban Greening*, 56, 1-9. <https://doi.org/10.1016/j.ufug.2020.126888>.
- Van den Bosch, M., & Sang, O. (2017) Urban natural environments as nature-based solutions for improved public health – a systematic review of reviews. *Environ. Res.* 158, 373–384. <https://doi.org/10.1016/j.envres.2017.05.040>.
- Venter, Z. S., Krog, N. H., & Barton, D. N. (2020) Linking Green Infrastructure to Urban Heat and Human Health Risk Mitigation in Oslo, Norway. *Science of Total Environment*, 709, 1-10. <https://doi.org/10.1016/j.scitotenv.2019.136193>.
- Venter, Z. S, Barton, D. N., Gundersen, V., & Figari, H. (2020) Urban nature in a time of crisis: recreational use of green space increases during the COVID-19 outbreak in Oslo, Norway: SocArXiv. [doi.org/10.31235/osf.io/kbdum](https://doi.org/10.31235/osf.io/kbdum).
- Wolch, J. R., Byrne, J., & Newell, J. P. (2014) Urban green space, public health, and environmental justice: The challenge of making cities 'just green enough. ' *Journal of Landscape and Urban Planning*, 125, 234-244. doi: 10.1016/j.landurbplan.2014.01.017.
- Zhang, Y., Van den Berg, A. E., Van Dijk, T., & Weitkamp, G. (2017) Quality over quantity: contribution of urban green space to neighbourhood satisfaction. *International Journal of Environmental Research and Public Health*, 14 (5), 535-542.
- Zijlema, W. L., Triguero-Mas, M., Smith, G., Cirach, M., Martinez, D., Dadvand, P., Gascon, M., & Julvez, J. (2017) The relationship between natural outdoor environments and cognitive functioning and its mediators. *Environ. Res.* 155, 268–275. <https://doi.org/10.1016/j.envres.2017.02.017>.
- Zuniga-Teran, A. A., Staddon, C., de Vito L., Gerlak, A. K., Ward, S., Schoeman, Y., Hart, A., & Booth, G. (2020) Challenges of Mainstreaming Green Infrastructure in Built Environment Professions. *Journal of Environmental Planning and Management*, 63 (4), 710-732.



# THE RELATIONSHIP BETWEEN SELF-EFFICACY BELIEFS AND CAREER CHOICES OF UNDERGRADUATE BUILT ENVIRONMENT STUDENTS

Mariam Akinlolu<sup>1</sup> and Theo C. Haupt<sup>2</sup>

<sup>1,2</sup>*Faculty of Engineering, Mangosuthu University of Technology, Durban, South Africa*

This study examines the relationship between career choices and career self-efficacy beliefs among a sample of South African university students. This study surveyed 229 conveniently sampled students, including 116 men and 113 women enrolled in construction-related programs at two universities in South Africa. The samples were drawn from student cohorts enrolled in construction management, civil engineering, property development, land surveying, building and quantity surveying. Adopting the Social Cognitive Career Theory as the study's theoretical framework, an exploratory factor analysis yielded support for 5-item scale of self-efficacy. The EFA provided support for the internal validity and reliability of the scale. Results of structural equation modeling indicated that a significant relationship exists between self-efficacy and the student's decision to undertake a career in construction. The Mann-Whitney U and Kruskal-Wallis test was conducted to test for gender and SES differences in the extent to which self-efficacy beliefs influenced a career choice in construction. No significant differences were found in the influence of self-efficacy beliefs between men and women. The study revealed significant differences between the high and medium SES groups. Findings of the current study have meaningful implication for practice in career choice and development in built environment occupations.

Keywords: career, self-efficacy, South Africa, university students

## INTRODUCTION

Construction education in South Africa is an interesting and peculiar context in which to study the gender-differences in career choices. The construction industry is demonstrably male-dominated, which makes it hard for women to persist in construction-related programs, as well as in the industry (Madikizela and Haupt, 2010; English and Le Jeune, 2012). Despite an extensive range of global legislation developed to promote women's participation in construction, women are still underrepresented in the construction industry, and more so among students in construction (Male et al., 2017; English and Le Jeune, 2012; Akinlolu and Haupt, 2019). While both first and third world countries share the problem of inadequate representation of women, women are very present in the construction workforce

<sup>1</sup> akinlolumariam@gmail.com

<sup>2</sup> pinnacle.haupt@gmail.com

of some developing countries compared to European countries (English and Le Jeune, 2012).

Making a career choice in the construction industry has not been a prevalent decision by women in South Africa (Enshassi and Mohammaden, 2012; Ozumba and Ozumba, 2012). Gender-related studies have revealed that women's career choices are affected by social and cultural role expectations (Powell et al., 2009). Due to South Africa's cultural diversity, many women are brought up with the understanding that they cannot undertake non-traditional careers such as construction and are advised to follow instead, 'soft skills' occupations such as nursing (Sangweni, 2015). Their primary roles are to take care of the family and nurture their children, while their spouses are the breadwinners and are entitled to the workplace (Madikizela and Haupt, 2010; English and Le Jeune, 2012). Putting women's roles in such stereotypical boxes is one of the hindrances that shorten the working life of women and makes it impossible to maintain an upward trend in the number of women in construction (Enshassi and Mohammaden, 2012).

Recent studies have begun to dismiss the assumption that references made to women include all women and that all women have similar experiences (Byrd, 2009; Flores et al., 2010). Although in the South African context women may share a common gender, their cultural and socio-economic backgrounds vary (Louw-Harmse, 2015). The differences in their environments may influence the extent to which socio-cultural factors affect their career decisions more than others. Findings from previous studies suggest that demography and socio-economic differences may have an impact on the career decisions of women and their perceptions of career-related barriers. The aspirations of children are influenced within the prevailing social and cultural environment in which they develop. Personality interests, family, school, media, socio-economic and geographic settings were found to have an impact on the professional aspirations of children (Watson et al., 2011). While scholars have begun seeking the role culture and society plays on the career decisions of women and their development at the workplace, fewer studies have focused on inter-group differences (Holvino, 2010). Likewise, although numerous researchers have suggested a convergence of major career development theories (Eccles et al., 1984; Hackett et al., 1991; Lent et al., 1994) most recognize that this has still not been achieved. Although there have been numerous studies on the experiences of women in the construction industry (Chileshe and Haupt, 2010; Vainikolo, 2017), few studies have attempted to view their experiences from a theoretical perspective to give a larger meaning to their career choices and development. The lack of empirical research in this area suggests that more in-depth exploration of this problem is required.

Self-efficacy has been found to play a strong predictor of career choice behaviors in individuals (Sawtelle et al., 2012). Self-efficacy belief which is the core construct of the Socio Cognitive Career Theory (SCCT) and typically influences a person's academic and professional aspirations is influenced by learning experiences (Saiffudin et al., 2013). These beliefs are influenced by a person's success at a given task, as this information is integrated into the person's self-concept in that specific domain. High levels of self-efficacy are related to the extent to which a person intends to undertake a career in a particular profession (Kelly, 2009). Since self-efficacy deals with feelings of being capable of executing a specific task, self-

efficacy constructs are strong predictors of career behaviours (Betz and Hackett, 1981; Sheu et al., 2010). Lent et al. (2007); Kelly (2009); Huang (2013) reported a positive correlation between the confidence of men and women in their abilities to complete necessary job tasks and educational requirements in construction. Students who had low self-efficacy of their abilities to persist in construction were unlikely to undertake such occupations (Kelly, 2009).

Similarly, Foud and Smith (1996) considered the concept of domain-specific self-efficacy by testing self-efficacy as a predictor for intentions and choice in STEM careers and found that, self-efficacy directly influenced intentions, which resulted to a direct impact on career choice. Also, the study found that there was a strong positive correlation between self-efficacy and career decisions. Several studies highlight gender and SES difference in perceived self-efficacy in the decision to undertake a particular career (Ali and McWhirter, 2006).

Applying SCCT, the current study focused on role of self-efficacy on career choice. This study examines the gender and SES differences in self-efficacy as it relates to the career choices of undergraduate students in the Built Environment in South Africa. The study further determines whether differences exist among men and women and students from different socio-economic categories in the influence of self-efficacy beliefs on career choices.

## **THEORETICAL FRAMEWORK**

This study was framed by the Social Cognitive Career Theory (SCCT) as it relates to the students' career choices in the construction industry. SCCT (Lent et al. 1994) is a direct application of the social cognitive theory by Bandura (1989) and elaborates exclusively on the educational interest formation, career development, performance, and persistence of individuals in their career endeavours. Processes whereby the educational and professional interest of individuals are developed; the influence of interests and other socio-cognitive mechanisms on career choices and the attainment of different levels of career performance and persistence are outlined in the SCCT (Lent et al., 1994; Ali and McWhirter, 2006). Of interest to the present study is the cognitive process of self-efficacy.

### **Self-efficacy**

Self-efficacy refers to "people's judgments of their capabilities to organize and execute courses of action required attaining designated types of performances" (Bandura, 1989). From the social-cognitive perspective, self-efficacy is a set of beliefs concerned with specific performance domains and interacts complexly with external and contextual factors (Shumba and Naong, 2012). These beliefs help to determine the choice of activities, environments, persistence, and emotional reactions to certain events (Malach-Pines and Kaspi-Baruch, 2008). Ali and McWhirter (2006); Kelly, (2009); Lent and Sheu (2010) described self-efficacy as a person's perception of their capabilities and ability to perform at certain levels in a specific domain, that influence certain events which have an impact on their lives. It is a conviction by a person that a target can be achieved (Hunt et al., 2017). Self-efficacy beliefs are predominantly determined by four sources: performance accomplishments, vicarious learning, social persuasion, and emotional arousal (Hunt et al., 2017). Commonly, a person has a higher level of self-efficacy when

they believe they have the required competency and efficacy to obtain necessary results (Bandura, 1977). Elements of self-efficacy are perceived to assist a person in determining their choice of activities, degree of persistence, and emotional reaction to situations (Peña-Calvo et al., 2016). Introduced to career development literature by Hackett and Betz (1981), self-efficacy has received wide attention in career literature and has been identified as a major predictor of choice to undertake and remain in a male-dominated career such as construction (Lent and Brown, 2006; Lent et al., 2008).

## **METHODOLOGY**

A quantitative research method was adopted for the study. The study used a close-ended questionnaire in a survey of university students enrolled in construction-related programs in South Africa. Based on the advantages of the non-probability sampling method, the study used a conveniently selected sample from two public universities in the KwaZulu-Natal province of South Africa to participate in the study. The two universities were conveniently chosen because of their proximity to the researcher. Convenience sampling consists of selecting participants who are closest and more convenient to access (Sekaran and Bougie, 2010). This sampling method was preferred to conveniently select two universities, which were closest to the research domicile. Undergraduate students enrolled in construction-related programmes such as construction management, land surveying, building, civil engineering, quantity surveying and architecture in South African Universities were chosen as the sample frame. A sample size of 229 was used for the analysis.

The survey questionnaire was administered for five weeks. The questionnaires were designed using Google forms and administered electronically by sending out hyperlinks to the questionnaire via email and the WhatsApp platform. Google forms is a cloud-based and online tool used to create and customize questionnaires.

To determine the normality of the data gathered, the Kolmogorov-Smirnov Z and Shapiro-Wilk test were adopted. The Kolmogorov-Smirnov Z and Shapiro-Wilk tests indicated a non-normal distribution at  $p=0.000$  for all the variables.

Following the result of the normality test, which revealed a non-normal distribution of data, a non-parametric test was deemed suitable to test for significant differences among the gender and SES groups concerning the study constructs. The study adopted the Mann-Whitney U test to the significant differences between the gender groups. Mann-Whitney U test is the non-parametric version of the parametric t-test used to assess independent samples. The Mann-Whitney U test compares the median of the two different groups on a continuous measure and converts the scores obtained to ranks. It then determines whether significant differences exist between the two groups (Pallant, 2011). The values to consider after the Mann-Whitney- U test are the Z value and the significance value, which is represented as the Asymp.Sig (2 tailed). A Sig. value of 0.05 or smaller ( $p \leq 0.05$ ) indicates a significant difference between groups.

In this study, the Kruskal-Wallis test was adopted to test for significant differences between the SES groups. Similar to the Mann-Whitney U test, the Kruskal-Wallis

test is the non-parametric alternative to the one- way analysis of variance test(ANOVA) and is used to test for significant differences among three or more independent groups by comparing the scores on continuous variables (Field, 2013). An alpha level of 0.05 or less suggests a significant difference between groups.

### Scale measures

The questions for the questionnaire survey were captured on a 5-point Likert scale where 1= strongly-disagree and 5= strongly agree. Respondents were required to indicate their level of agreement with statements about their career choices.

The scales utilized for the study are introduced below;

To measure self-efficacy in this study, the short version of the 25-item career choice self-efficacy scale derived from Betz, Klein, and Taylor (1996) was adopted and compressed.

## DATA ANALYSIS

### Demographic Information

Table 1 presents the demographic distribution of the respondents. There were 116 men (50.7%) in the sample. First year students had the largest number of participants with 94 students (41%), followed by 2nd year students at 87 (38%). This rate of participation is possible because of the 1st year cohort of students at South African Universities being usually larger than the later years or more advanced levels of study.

**Table 1: Demographic distribution**

Gender	No	Percent
Man	116	50.7%
Woman	113	49.3%
Total	229	100.00%
Year of Study		
1 <sup>st</sup> year	94	41.0
2 <sup>nd</sup> year	87	38.0
3 <sup>rd</sup> year	30	13.1
4 <sup>th</sup> year	18	7.9
Total	229	100.00%
Programme of Study		
Construction Management	110	48.0
Land Surveying	4	1.7
Quantity Surveying	50	21.8
Civil Engineering	17	7.4
Building	47	20.5
Architecture	1	0.4
Total	229	100.00%

Most respondents were enrolled in the discipline of Construction Management (n= 110; 48%), which also accounted for the largest number of participants because of both participating universities offering the programme. Architecture had the

lowest number of students ( $n=1$ ; 0.4%) in the sample because only one of the universities offered the programme and typically had smaller numbers of students compared to the other disciplines and programmes.

To determine the socio-economic background of the respondents, participants were required to indicate the current or last occupation and the highest qualification of the breadwinner of their household.

Table 2 presents results relating to the socio-economic data of the participants. Most of the household breadwinners were unskilled workers such as housekeepers, farmers, waiters, and gardeners ( $n= 161$ ; 70.3%), followed by graduate workers such as teachers, nurses, and police officers ( $n=39$ ; 17%).

**Table 2: Socio-economic background**

Occupation of the breadwinner of the household	No	Percent
Unskilled	161	70.3
Skilled	21	9.2
Graduate	39	17.0
Specialist	8	3.5
Highest qualification of the breadwinner of the household	No	Percent
Post- Matric	59	25.7
Matric	54	23.7
High School	59	25.7
Primary School	57	24.9
Socio-economic Category	No	Percent
High SES	42	18.3
Medium SES	54	23.6
Low SES	133	58.1
Total	229	100.00%

Concerning the highest qualification of the household breadwinner, 59 (25.7%) had post-matric education, 54 (23.7%) had matric education, 59(25.7%) had high school education, and 57(24.9%) had primary school education. Based on the occupation and the highest qualification of the breadwinner of the household, 133 (58.1%) of the students were categorised to be of low socioeconomic status.

### Exploratory Factor Analysis (EFA)

Exploratory Factor Analysis (EFA) was used to test the reliability and validity of the variables assessed in the study. The EFA aims to reduce data by finding the smallest manageable set of common components that will account for the intercorrelations of a set of variables (Pallant, 2011). The steps involved in the EFA include assessment of the suitability of the data for factor analysis, determining numbers for factor extraction, retaining and rotation, interpretation of resulting factors. The analysis included the evaluation of reliability (Cronbach alpha and composite), and discriminate and convergent validity of the survey instrument.

To determine the strength of intercorrelation among the variables, the Bartlett's Test of Sphericity and the Kaiser-Meyer-Olkin (KMO) measure of sampling adequacy test was used to assess the data's factor suitability (Pallant, 2011). Factor analysis is deemed appropriate when the value of the Kaiser-Meyer-Olkin Measure



of Sampling Adequacy (KMO) is higher than the acceptable minimum limit of 0.6 and a limit of 1 (Tabachnick and Fidell, 2013). The cut-off value of .05 for the Bartlett's Test of Sphericity indicates the significance and appropriateness of the factor model (Hair et al., 2010). Dimensionality and significance of factors were determined using Maximum likelihood. Maximum likelihood factoring is beneficial for confirmatory analysis and calculates population values for factor loadings that maximize the likelihood of sampling the observed correlation matrix from a population (Pallant, 2011). The Kaiser's criterion or the eigenvalue rule was adopted to determine the number of factors to retain (Pallant, 2011; Tabachnick and Fidell, 2013).

Five items of the self-efficacy scale were analysed. Inspection of the corrected item-total correlation values were above 0.3, indicating that the items measured the self-efficacy construct adequately. The Kaiser-Meyer-Olkin (KMO) for self-efficacy was 0.846 and a Bartlett's test of Sphericity with  $p < 0.000$  was obtained as shown in Table 3. A Cronbach's alpha of 0.836 was obtained for the self-efficacy scale, indicating adequate internal reliability. The results meet the criteria for factor analysability.

**Table 3: KMO and Bartlett's Test for Self-Efficacy**

KMO and Bartlett's Test		
Kaiser-Meyer-Olkin Measure of Sampling Adequacy.		.846
	Approx. Chi-Square	414.757
Bartlett's Test of Sphericity	Df	10
	Sig.	.000

As shown in Table 4, factor loadings for all the five items were above the cut-off value of 0.30. For the communalities, all the factors were less than 0.999, indicating that all the items were within an acceptable range, and could be perceived as key factors determining the influence of self-efficacy on career choice.

**Table 4: Self-efficacy factor statistics**

Item	Element	Factor Loading	Corrected item-total correlation	Communalities	
				Initial	Extraction
SEF1	I have confidence in my ability to identify resources, limitations, and personal characteristics that might influence my career choices.	.693	.629	.406	.480
SEF2	I am confident about being able to collect information about training and employment opportunities for myself and manage them effectively.	.602	.557	.314	.362
SEF3	I am confident about being able to develop lists of priorities on the effective actions to successfully manage my own personal professional development	.622	.575	.333	.387
SEF4	I am confident about being able to plan the steps needed to realize a project related to my profession	.857	.750	.576	.734
SEF5	I am confident about being able to address any difficulties related to my career	.773	.681	.498	.598

From the results presented in Table 5, one factor with an eigenvalue of 3.024 accounted for 60.478% of the variance. The total variance explained is above the recommended cut-off value of 50% (Field, 2013). Since only one factor was extracted, it was unnecessary to rotate the solution. The solution was therefore considered unidimensional and adequate evidence of convergent and discriminant validity was provided for the self-efficacy construct.

**Table 5: Initial eigenvalues for self-efficacy**

Factor	Initial Eigenvalues		
	Total	% of Variance	Cumulative %
1	3.024	60.478	60.478
2	.604	12.084	72.562
3	.580	11.593	84.155
4	.479	9.577	93.732
5	.313	6.268	100.000

### ***Multivariate analysis to assess gender differences***

To test for significant differences between men and women, with regards to the five assessed self-efficacy variables, the Mann-Whitney U test was conducted.

Table 6 shows the mean scores for the career choice predictor, their rank orders for men group, women group and men and women combined. The Z-value and the Sig. value obtained from the Mann-Whitney U test were also presented. On the self-efficacy construct men reported a mean score of 20.51 while women reported 19.64.

Results of the Mann-Whitney U test revealed no significant differences among the gender groups with regards to their perception of the influence of self-efficacy (Z value = -1.380,  $p=0.168$ , as the Sig. values were less than the cut-off value of 0.05.

**Table 6: Test Statistics for Gender and Career choice predictors**

	Men	Women	Mann-Whitney U	
	MIS	MIS	Z-value	Sig.
Self-Efficacy	20.51	19.64	-1.380	0.168

### ***Multivariate analysis to assess SES differences***

Table 7 shows the mean scores for the self-efficacy variable, their rank orders for the high SES, medium SES and low SES groups. The Chi-square value, degree of freedom (df) and Sig. value obtained were also presented.

To test for the significant differences in the influence of self-efficacy between the SES groups, the Kruskal Wallis test was conducted. Table 7 shows that significant differences were found among the SES groups for self-efficacy (Chi-square = 12.361,  $p=0.002$ ), as the Sig. value was less than the alpha value of 0.05.

**Table 7: Test Statistics for SES and Self-efficacy**

	High SES	Medium SES	Low SES	Kruskal-Wallis		
	MIS	MIS	MIS	Test Static	Df	Sig.
Self-Efficacy	20.71	16.83	19.51	12.361	2	0.002

A post-hoc procedure was conducted to determine where the significant .

**Table 8: Analysis of Dunn- Bonferroni Test**

		Test Static	Std. Error	Adj. Sig.
Self-Efficacy	High-Low SES	18.819	13.556	0.495
	High-Medium SES	39.094	11.662	0.002
	Low-Medium SES	20.275	10.632	0.170

For self-efficacy, there was substantial evidence ( $p < 0.002$ ) of a difference between high and medium SES group, as shown in Table 8. The mean score for the high SES was 19.51 compared to 16.83 for the medium SES group.

## DISCUSSION

### **Gender differences in the influence of self-efficacy**

Gender has been identified to play a significant role in determining educational and career choices (Buchmann and Dalton, 2002). By viewing gender as a socially constructed aspect of the experience, it may be emphasized that it is a major sociocultural agent that helps shape career choices (Saifuddin et al., 2013). Findings from Wynn and Correll (2017) suggested that men and women have different perceptions of how self-efficacy beliefs influence their career decisions in male-dominated professions such as construction, as these professions have been resistant to the participation of women.

Findings from the study revealed no significant differences in the influence of self-efficacy among men and women.

Consistent with the findings in this study (Kelly, 2009; Huang, 2013; Starnarski and Son Hing, 2015) reported a positive correlation between the confidence of men and women in their abilities to complete necessary job tasks and educational requirements in construction. Students who had low self-efficacy of their abilities to persist in construction were unlikely to undertake such occupations (Kelly, 2009).

### ***SES differences, self-efficacy and career choice***

Socio-economic status is a person input variable that may influence a person's career choice (Ali and McWhirter, 2006). In this study, socioeconomic status (SES) was determined using a combination of the Nakao-Treas Socio-economic index and the Four Factor Index of Social Status based on ratings of occupation, education, income, and marital status (Nakao and Treas, 1994; Hollingshead, 1975). This index accounts for differentiated and unequal social status. Consistent with Blustein et al. (2015) this study determined the socio-economic status of young adults based on that of their parents or the head of their household, as they had not yet established their own (Ali and McWhirter, 2006). Diemer and Hsieh (2008) identified social class as a key variable that influences the way in which individuals make their career decisions. Trusty et al. (2000a); Trusty et al. (2000b); Diemer and Hsieh (2008) opined that students from lower SES backgrounds compared to those from higher SES backgrounds may have limited access to information, career guidance and financial resources, which could limit their choice of careers.

A statistically significant difference was found for the influence of self-efficacy on career choice among the three SES categories. Further tests revealed that disparities existed between the high SES and medium SES categories. These findings are consistent with previous studies indicating that group differences exist on self-efficacy with career choice (Ali and McWhirter, 2006; Gushue and Whitson, 2006).

Gushue and Whitson (2006) examined the influence of socio-economic background as related to self-efficacy and career decisions in traditionally male-dominated environments high school students and postulated that higher levels of self-efficacy was strongly associated with academic and career choice. Hannah and Kahn (1989) examined the influence of SES on self-efficacy, and on the careers considered by high school students, and found that low SES students reported lower self-efficacy beliefs compared higher SES students.

An investigation of the school-to-work transition of young adults from various SES backgrounds, conducted by (Kelly, 2009) revealed that respondents from high SES backgrounds reported higher levels of confidence in their abilities and career adaptability compared to their counterparts from other SES backgrounds. This finding is also consistent with past studies highlighting the influence of SES backgrounds on career choices (Trusty et al., 2000a; Trusty et al., 2000b). Respondents who aspired to undertake careers in construction-related professions reported higher SES. Consistent with Moore (2006) career choices in the construction industry is perceived as the least option; findings indicate that a career in construction is unappealing to students from impoverished backgrounds.

In the current study, students from high SES backgrounds indicated higher self-efficacy than their lower counterparts, as demonstrated by the mean scores. Empirical findings from (Ali and McWhirter, 2006; Lent et al., 2008) reported that societal issues influence career decisions, and these influences can be differentiated by an individual's personal circumstances such as poverty and parent's professional status. Ali and Saunders (2006) argued that students from lower SES backgrounds may have lower self-efficacy beliefs compared to their counterparts from higher SES backgrounds which has the potential influence their career choices. Lent et al. (2002) also argued that "how individuals construe the environment and themselves also affords the potential for personal agency and a sense of reliance in one's career development".

## **CONCLUSIONS**

The study reported on focused on the role of self-efficacy on career choice in general and in construction in particular. More specifically, the gender and socio-economic status (SES) differences in self-efficacy of undergraduate construction students in South Africa were examined as they related to their career choices. This study confirmed that a relationship existed between self-efficacy and the decision of a student to pursue a career in the construction industry. However, no significant gender differences were found in the influence of self-efficacy beliefs between men and women. A positive correlation existed between the confidence of men and women in their abilities to complete necessary construction job tasks and activities and the requirements of construction-related education. Students who had low

self-efficacy about their ability to succeed in the construction industry were unlikely to want to work in the sector. On the other hand, students from high SES backgrounds had higher self-efficacy and were more likely to consider construction as a career option. Finally, given that very few studies have attempted to view the experiences of university students in construction programs from a theoretical perspective to determine what drives their career choices and development, further research in this area is required.

## REFERENCES

- Akinlolu, M., & Haupt, T. C. (2019) July. Investigating a Male-Dominated Space: Female Students' Perceptions of Gendered Cultures in Construction Workplaces. In Construction Industry Development Board Postgraduate Research Conference (pp. 43-55). Springer, Cham.
- Ali, S. R., & McWhirter, E. H. (2006). Rural Appalachian youth's vocational/educational postsecondary aspirations: Applying social cognitive career theory. *Journal of career development*, 33(2), pp.87-111.
- Ali, S. R., & Saunders, J. L. (2006). College expectations of rural Appalachian youth: An exploration of social cognitive career theory factors. *The Career development quarterly*, 55(1), pp.38-51.
- Bandura, A. J. P. R. (1977). Self-Efficacy: Toward A Unifying Theory of Behavioral Change. 84, 191.
- Bandura, A. J. (1989). Human Agency in Social Cognitive Theory. 44, 1175.
- Betz, N. E., Klein, K. L., & Taylor, K. M. (1996). Evaluation of a short form of the career decision-making self-efficacy scale. *Journal of career assessment*, 4(1), pp.47-57.
- Blustein, D. L., Kozan, S., Connors-Kellgren, A., & Rand, B. (2015). Social class and career intervention.
- Buchmann, C., & Dalton, B. (2002). Interpersonal influences and educational aspirations in 12 countries: The importance of institutional context. *Sociology of education*, pp.99-122.
- Byrd, M. (2009). Theorizing African American women's leadership experiences: Socio-cultural theoretical alternatives. *Advancing Women in Leadership Journal*, 29.
- Chileshe, N., & Haupt, T. C. (2010). An empirical analysis of factors impacting career decisions in South African construction industry. *Journal of Engineering, Design and Technology*.
- Diemer, M. A., & Hsieh, C. A. (2008). Sociopolitical development and vocational expectations among lower socioeconomic status adolescents of color. *The Career Development Quarterly*, 56(3), pp.257-267.
- Eccles, J. (1984). Sex differences in achievement patterns. In *Nebraska symposium on motivation*. University of Nebraska Press.
- English, J., & Le Jeune, K. (2012). Do professional women and tradeswomen in the South African construction industry share common employment barriers despite progressive government legislation? *Journal of Professional Issues in Engineering Education and Practice*, 138(2), pp.145-152.
- Enshassi, A., & Mohammaden, A. (2012). Occupational deaths and injuries in the construction industry.

- Field, A. (2013). *Discovering statistics using IBM SPSS statistics*. sage.
- Flores, L. Y., Ramos, K., & Kanagui, M. (2010). Applying the cultural formulation approach to career counseling with Latinas/os. *Journal of Career Development*, 37(1), pp.411-422.
- Gushue, G. V., & Whitson, M. L. (2006). The relationship of ethnic identity and gender role attitudes to the development of career choice goals among black and Latina girls. *Journal of counseling psychology*, 53(3), p.379.
- Hackett, G. & Betz, N. E. (1995). *Self-Efficacy and Career Choice and Development. Self-Efficacy, Adaptation, And Adjustment*. Springer.
- Hackett, G., Lent, R. W. & Greenhaus, J. H. (1991). Advances in Vocational Theory and Research: A 20- Year Retrospective. *Journal of Vocational Behavior*, 38, 3 38.
- Hannah, J.-A. S. & Kahn, S. E. (1989). The Relationship of Socioeconomic Status and Gender to The Occupational Choices of Grade 12 Students. 34, 161-178.
- Hollingshead, A. B. (1975). Four factor index of social status.
- Holvino, E. (2010). Intersections: The simultaneity of race, gender and class in organization studies. *Gender, Work & Organization*, 17(3), pp.248-277.
- Huang, C. (2013). Gender differences in academic self-efficacy: A meta-analysis. *European journal of psychology of education*, 28(1), pp.1-35.
- Hunt, J. M., Langowitz, N., Rollag, K. & Hebert-Maccaro, K. J. (2017). Helping Students Make Progress in Their Careers: An Attribute Analysis of Effective Vs Ineffective Student Development Plans. 15, 397-408.
- Kelly, M. E. (2009). Social cognitive career theory as applied to the school-to-work transition.
- Lent, R. W., & Brown, S. D. (2006). Integrating person and situation perspectives on work satisfaction: A social-cognitive view. *Journal of vocational behavior*, 69(2), pp.236-247.
- Lent, R. W., Brown, S. D., & Hackett, G. (1994). Toward a unifying social cognitive theory of career and academic interest, choice, and performance. *Journal of vocational behavior*, 45(1), pp.79-122.
- Lent, R. W., Sheu, H.-B., Singley, D., Schmidt, J. A., Schmidt, L. C. & Gloster, C. S. (2008). Longitudinal Relations of Self-Efficacy to Outcome Expectations, Interests, And Major Choice Goals in Engineering Students. 73, 328-335.
- Lent, R. W., Brown, S. D. & Hackett, G. (2002). Social Cognitive Career Theory. *Career Choice and Development*, 4, 255-311.
- Lent, R. W., & Sheu, H. B. (2010). Applying social cognitive career theory across cultures: Empirical status.
- Louw-Harmse, Y. A. S. (2015). *Gender imbalance: a focus on senior management positions in the IT sector in South Africa (Doctoral dissertation, Cape Peninsula University of Technology)*.
- Madikizela, K., & Haupt, T. (2010). Influences on women's choices of careers in construction: A South African study.
- Malach-Pines, A., & Kaspi-Baruch, O. J. (2008). The Role of Culture and Gender In The Choice of A Career In Management. 13, pp.306-319.
- Moore, J. D. (2006). *Women in Construction Management: Creating A Theory Of Career Choice and Development*, Colorado State University.

- Nakao, K., & Treas, J. (1994). Updating occupational prestige and socioeconomic scores: How the new measures measure up. *Sociological methodology*, pp.1-72.
- Ozumba, A., & Ozumba, C. (2012). Women in Construction in South Africa: Investigating the Feminine Footprint of the South African Construction Industry. *Journal for the Advancement of Performance Information and Value*, 4(1), pp.28-28.
- Peña-Calvo, J. V., Inda-Caro, M., Rodríguez-Menéndez, C., & Fernández-García, C. M. (2016). Perceived Supports and Barriers for Career Development for Second-Year Stem Students. 105, pp. 341-365.
- Pallant, J. (2011). *Spss Survival Manual: A Step-by-Step Guide to Data Analysis Using Ibm Spss*, Routledge
- Powell, A., Bagilhole, B., & Dainty, A. (2009). How women engineers do and undo gender: Consequences for gender equality. *Gender, work & organization*, 16(4), pp.411-428.
- Saifuddin, S. M., Dyke, L. S., & Rasouli, M. (2013). Gender and careers: a study of persistence in engineering education in Bangladesh. *Gender in Management: An International Journal*.
- Sangweni, N. (2015). Women in construction: hindrances that shorten the professional working life of female site engineers on construction sites in South Africa (Doctoral dissertation, University of the Witwatersrand, Faculty of Engineering and the Built Environment).
- Sawtelle, V., Brewe, E., & Kramer, L.H. (2012). Exploring the relationship between self-efficacy and retention in introductory physics. *Journal of research in science teaching*, 49(9), pp.1096-1121.
- Sekaran, U., & Bougie (2010). *Research methods for business: A skill building approach*.
- Sheu, H.-B., Lent, R. W., Brown, S. D., Miller, M. J., Hennessy, K. D., & Duffy, R. D. (2010). Testing the Choice Model of Social Cognitive Career Theory Across Holland Themes: A Meta- Analytic Path Analysis. 76, pp.252-264.
- Shumba, A., & Naong, M. (2012). Factors influencing students 'career choice and aspirations in South Africa. *Journal of Social Sciences*, 33(2), pp.169-178.
- Stamarski, C. S., & Son Hing, L.S. (2015). Gender inequalities in the workplace: the effects of organizational structures, processes, practices, and decision makers ' sexism. *Frontiers in psychology*, 6, p.1400.
- Tabachnick, B. G., & Fidell, L. S. (2013). *Using multivariate statistics: International edition*. Pearson.
- Trusty, J., Ng, K. M. & Plata, M. J. (2000a). Interaction Effects of Gender, Ses, And Race-Ethnicity on Postsecondary Educational Choices of Us Students. 49, 45-59.
- Trusty, J., Robinson, C. R., Plata, M., Ng, K. M., & Development (2000b). Effects of Gender, Socioeconomic Status, And Early Academic Performance on Postsecondary Educational Choice. 78, 463-472.
- Vainikolo, K. (2017). Women's Career Paths in the Construction Industry in New Zealand (Doctoral dissertation, Auckland University of Technology).
- Watson, M., McMahon, M., & Longe, P. (2011). Occupational interests and aspirations of rural black South African children: Considerations for theory, research and practice. *Journal of Psychology in Africa*, 21(3), pp.413-420.
- Wynn, A. T. & Correll, S. J. (2017). Gendered Perceptions of Cultural and Skill Alignment in Technology Companies. 6, 45.



# THE RELATIONSHIP OF ATTITUDE AND PERCEIVED BEHAVIORAL CONTROL ON BEHAVIORAL INTENTION TO PRACTICE SURVEYING

Ayodele Oduwole<sup>1</sup>

*Surveying and Geoinformatics Department, the Federal Polytechnic Ilaro, Nigeria.*

User acceptance of information technology is attributed to individual's intention to engage in an activity or venture and perception that are factored by many indicators called items. Surveying education and practice involves series of theories and practical instructions that aimed at providing background knowledge and procedures in obtaining information about real world phenomenon. This research evaluated the behavioural intention to practice as exercised by surveyors using the Users Acceptance of Information Technology's Technology Acceptance Model (TAM)(Grun, 1998; Jatau, Fernandes, Adebomehin, and Gonçalves, 2010; Larson, 1977; RICS, 2014; Sekaran, 2003; Sharma, 1997) and Theory of Planned Behaviour (TPB). The research relied on survey instruments structurally built to obtain manifest/items that measures intention and perception based on TAM and TPB. The questionnaires and all the information gathered duly processed to obtain valid indicators that can sufficiently explain the impact and relationship among variables under consideration. Partial Least Squares - Structural Equation Modelling (PLS-SEM)(Fajemirokun, 2006) was the statistical method used for the analysis of latent constructs of endogenous and endogenous variables. The entire analysis was done with SmartPLS 3 software. The model was validated and hypotheses tested. Results shows the significance of the variables on each other, which exposes the relationship between latent constructs and their variables. It shows that self-efficacy has high impact on Perceived Behavioural Control and the latter as an important variable to measure Behavioural Intention to Practice

Keywords: PLS-SEM, practice, smartPLS, surveying, and technology acceptance model

## INTRODUCTION

The use of information technology requires considerable depth of understanding that has narrowed the field of expertise of many individual practitioners. Many are factors attributed to behavioral intention such as, ease of use, usefulness, attitude etc.

This study evaluates the factors of affects intention and perception. It further inquire to understand the factors that affect behavioral Intention to surveying practice. The significance of the research centers around reviewing the perception

---

<sup>1</sup> ayodele.oduwole@federalpolyilaro.edu.ng Tel. +2348034532643



of different stakeholders involved in the practice of surveying in the federation. Understanding practitioner's belief and view of the profession, the relationship between indicators and their impacts on intention and perception will be necessary. The observations and information gotten would be a source of information for stakeholders and used in understanding surveyor's view. This research tends to show the behavioral intention of all parties in the profession as regards to intention to practice surveying. Although many researches are on determining the relationships between the factors, that influences intention and perception of practitioners in many fields, no method is adopted the best approach. This study contributes to knowledge by identifying suitable methods for such relations in SEM applications. The information obtained through this research would guide decision makers in dealing with issue in these perspectives.

### **Professional surveyors**

As there is no single, certain definition of professionals, there is an emerging consensus that professionals are individuals in occupations that have achieved professional status of special power and prestige because of their special competence in esoteric bodies of knowledge (Larson 1977; Sharma 1997). In other words, the key distinguishing characteristic of professionals is the license they exclusively own and apply. No one outside the profession has the license to practice surveying. Many privileges come with achieving professional status through the exclusive license to practice; among them, professional autonomy is the most important. With such autonomy, professionals are trusted to work conscientiously without supervision as well as to undertake proper regulatory action on those rare occasions where an individual does not perform his work competently or ethically. Therefore, peer review processes under professional autonomy measured job performances of professionals. However, performance measures may or may not have been established in some professions and may reflect the true job performance of a professional due to the nature of professional work. The privilege of professional autonomy is justified by the belief that individuals outside the profession do not possess the professional knowledge needed to evaluate the practices of the professionals and protect themselves against incompetence, carelessness, and exploitation in the profession. Performance measures not established in some other professions increased this autonomy (Walter and Lopez, 2008). Thus, professionals proclaim that they are in the best position to operate, control, and regulate their own practices. The process of professionalization in which they establish rules and procedures to regulate their own practices (e.g., codes of conduct) help them gain the trust of individuals outside their profession and obtain professional autonomy. Professional autonomy in turn enforces other privileges such as social status, resource control. Where professional hierarchies exist, there is professional dominance over subordinate para-professions (Walter and Lopez, 2008).

In the surveying parlance in Nigeria, the Surveyors Council of Nigeria (SURCON), the Nigerian Institution of Surveyors (NIS) and its supervisory body (Akinola and Ojo, 2014), lay down both the professional ethics and the code of practice governing the profession. The SURCON Decree 44 of 1989 is the only authorized regulation vested with the powers of regulating and controlling the practice of the profession in all ramifications.

There is a dearth in literatures on evaluation of the factors that affect intention and perception to practice surveying. Many researches on the theory of user acceptance of information technology are available, but none modelled the relationship between factors and impact of intention and perception on survey practice. There is an ongoing research on the various variables that affect the intention and perception based on user acceptance of information technology. Many authors have published on this new area in many different regions, context and targets. However, the coverage is minimal, hence, the main reason for undertaking the research. It is therefore important to contribute to the research community by adding findings on intention and perception of surveying practice in the context of User Acceptance of Information Technology, Technology Acceptance Model, Theory of Planned Behavior and Theory Reasoned Action.

### **Professional surveying issues in Nigeria**

Modelling the intention of these practitioners is necessary; to better understand the factors that affects the acceptance of technology that influence their choice of practice. User Acceptance of Information Technology is a body of knowledge that helps in evaluating the factors and indicators that influences the intention and perception using the models that supports this theory such as Technology Acceptance Model, Theory of Reasoned Action and the Theory of Planned Behavior. Path Modelling in Structural Equation Modelling (SEM) is a mathematical tool that is capable of examining the relationship and impact of indicators on the variables (intention and perception) they measure. There may be lot of other publications on intention and perception of practitioners, but few adopted the Structural Equation Modelling using Partial Least Squares as an analytical method and tool. It has become very necessary therefore to evaluate the positions of these practitioners in terms of their intention and perception respectively; this will also serve as a reference document in determining ways to bring sustainable solutions to the underlying issues. This research is important in contextualizing the perception of the stakeholders and effectively documenting the views of important bodies in surveying to help manage opinions uniformly to enact new sets of law. In this new research focus, the method employed Structural Equation Modeling (SEM), a second-generation statistical method; as a multivariate statistical tool. Technology Acceptance Model (TAM) used to model the relationship between dependent variables (intention to practice) and independent variables (perception of practicing surveyors).

## **LITERATURE REVIEW**

### **Surveying and its practice**

The definition of surveying with advent of computers is the science and technology of taking measurements on, above and under the surface of the earth and its representation on a plan or map. Grun (1998) referred to these enlarged tasks of Surveying as Geomatics and defined as the science of acquisition, management, modelling, analysis and representation of spatial data and processing with specific consideration of problems related to spatial planning, land use/land development and environmental issues. Recent advances in computer, digital, information and satellite technologies have influenced tremendously the practice of surveying all over the world. Rapid technological development has positively affected the scope, methods, volume and speed of data acquisition, processing, storage, management

and production of maps and allied products. The evolution of Internet has also revolutionized the field of Information Technology, and made the world a global village. Advances in digital technology and globalization have imposed a multi-disciplinary approach on survey and mapping. The advent of globalization has also brought about the collapse of professional boundaries; it is no longer possible to clear-cut professional boundaries. In other words, it is not easy to say where surveying for example ends and civil engineering starts. Professional boundaries, i.e. boundary lines demarcating one profession from another are collapsing. The traditional parcel boundary demarcation, which had been the preserve of surveyors, has turned into a major pre-occupation. Technology has changed the instrumentation for surveyors much to the exclusion of those practicing in traditional ways. Data processing and management techniques are the major concern of the survey world in which data quality are favorably increased. Poor service engagement, boundaries collapse, inadequate training, lack of interest in surveying with concerted effort aimed at self-promotion and clear vision are some of the challenges surveying profession in Nigeria has to tackle with in order to ensure its future and survival. A Surveyor in Nigeria is someone recognized by the Council as passing through all the processes to practice professionally. Such duly registered individuals are obligated to promote the highest level of professional practice to the end of delivering high quality and efficient service to their clients in adherence to the provisions of the overseeing bodies. Doubtlessly, the self-efficacy of early surveyors held high the torch of integrity in the discharge of their duties in difficult terrains and personal discomfort notwithstanding. Given credence to this fact are professional monuments of high significance and unfading relevance. Examples of such monuments are the products of the first geodetic surveys of Nigeria performed by the British Royal Engineers in 1910-12. The geodetic (horizontal and vertical) networks started observation in the late 1920s and most of the network materialized between the late 1940s and early 1960s. Those networks are been used and are still in use extensively in land management, urban development, physical planning, mineral exploration, road and water transportation etc. this was because the perceived the usefulness initially and allowed their intentions to materialize without allowing subjective norms and low motivations disrupt actualizing the aim (Jatau et al 2010).

Hard-to-access hilltops or high grounds harbor triangulated points of those networks such that one could only wonder how those early surveyors accessed those locations; what with large instruments to carry along (Fajemirokun, 2006). Yet all they had were such crude equipment as Gunter chains, Invar tapes, and few precision equipment like geodetic theodolite. In addition, worthy of note is the volume of rigorous after-field processing involved in getting those jobs done. Interestingly, mainly British personnel carried out those early survey works. The surveying profession has its roots in practice rather than theory. Thus in the early days, an intending professional surveyor was only sent to a surveyor already reputed in the practice for training (Thompson, 1968). However, even then, they expressed concerns about the need for theory to complement practice. The relatively recent phenomenon of 'professionally accredited degree' would suggest a concurrence with the need for professional training of surveyors for deeper knowledge in theoretical training. So, as with other professions (law, medicine and

divinity), modern day surveying education provides training in both theory and practice, with the latter delivered by others who are already experienced.

Professional bodies such as the Nigerian Institution of Surveyors, Surveyors Registration Council of Nigeria, usually oversee the process of professionalization. These institutions stress competence in the training of surveyors. With such rich background and professional history, one could expect the highest level of professional etiquette and strict adherence to ethics from the modern surveyor. However, this is hardly the case. In recent times, queries are on the character and status of the modern Nigerian surveyor especially in areas of cadastral concerns. There are forged survey plans used in land registrations and approving building plans. Survey beacons demarcating parcel boundaries seen with archaic identities, which is a telltale sign of foul play to the discerning eye. The abnormalities mentioned above deter professionalism and integrity expected in surveying practice.

### **Challenges of surveying profession in Nigeria**

The profession of Surveying in Nigeria faced currently with a number of problems that needs address for effective professional growth and development. The first step towards addressing the problems is to identify the problems and then proffer solutions to them. One of the major problems of professional surveying practice in Nigeria is lack of co-operation and personal greed among surveyors in private and public sectors have not helped the profession. Surveyors in the public sector often feel that their colleagues in the private sector are too comfortable and deliberately become hard on them in the award of contracts. In some cases, there are allegations that surveyors in government work out some arrangement to execute public sector works or nominates while paying a private sector registered surveyor to sign the plans. In addition, it seems that for some reason, surveyors in both public and private sector find it difficult to collaborate with their colleagues in universities, polytechnics and research institutes in addressing some of their problems. These are the normative beliefs that controls their perception; it also affects their motivation to comply with certain rules, procedures and practices. All these are to be analyzed in this study. Typical examples include the issues of the adjustment of the Nigerian geodetic networks, analysis of the GPS network by Federal Surveys, oil spillage and other environmental hazards to mention but a few. It must, however, be acknowledged that some of our surveyors have encouraged research and co-operative efforts between institutions of higher learning and their personnel.

### **Professional ethics**

Professional ethics encompass the personal, organizational and corporate standards of behavior expected of professionals. Professionals and those working in acknowledged professions, exercise specialist knowledge and skill. How to govern this knowledge when providing service to the public is a moral issue and termed professional ethics (RIBA, 2005). Some professional organizations define their ethical approach in terms of a number of discrete components (RICS, 2014). Typically, these include honesty, integrity, transparency, accountability, confidentiality, objectivity, respectfulness, obedience to the law, loyalty. Surveying and mapping places emphasis on harmonizing standards for spatial data capture and exchange, the co-ordination of data collection and maintenance activities and

the use of common data base by different agencies, thereby promoting the use of spatial information in decision making and removing impediments to the use of spatial information. Now, organizations and institutions responsible for surveying and mapping are full of institutional and organizational deficiencies, which need tackling in order to perform their duties efficiently and in particular be able to respond promptly to the ever changing and improving users' requirements. Modern Instrumentation and equipment in the Surveying and Mapping sector are technology based. Training personnel to acquire new knowledge and expertise for the use of these technological movement is capital intensive and it also requires human capital that are capable of transmitting knowledge when so needed. This requires huge capital outlay in foreign exchange and consistency in funding in order to meet the requirement for critical capacity building in terms of instrumentation, personnel and labor development. The Federal and State budgetary allocation for Surveying and Mapping operations had declined steadily over the past two decades. Over this period, the approved annual allocation by government to Surveying and Mapping activities through the Federal and State Surveys Department were always less than 10% of the capital budget proposals of the department. Nevertheless, some evaluation on the interest, belief, attitude, behavior and perception of stakeholders of surveying profession will help in making good plans, policy papers and strategies to further enhance productivity and sustenance, hence the reason for this research work.

### **Theory of Planned Behavior (TPB)**

In this study, the theoretical framework centered based on intention. This is based on Ajzen's 1991 Theory of Planned Behavior (TPB), an extension of the 1975 Theory of Reasoned Action (Bebetsos, Derri, Zafeiriadis, and Kyrgiridis). The TPB states that, a combination of attitude toward the behavior, subjective norm and perceived behavioral control form intention. Before one performs behavior, an individual must have intention for those behaviors. In addition to these variables, other factors such as educator characteristics (ethnicity, years of teaching, educational attainment level, and training) influence intention. Studies about intention are applicable in this study for the following reasons: (a) are built on a social psychology foundation; (b) they focus on perceptions and attitudes; (c) they deal with how attitude and perceptions affect behavioral outcomes. The best predictor of an individual's behavior is his or her intention to engage in that behavior (Casio, Dal Lin, and Falk, 2013);(Glasman and Albarracín, 2006).

### **Technology Acceptance Model (TAM)**

Davis developed TAM in 1989 as a standout amongst the most well known research models to the extent users can embrace and utilize information systems and technology. TAM generally considered and confirmed by various researches that assessed the individual technology acceptance behavior in various information systems concepts.

In TAM framework, two main factors affect the user's intention of using innovative technology; these are perceived usefulness and perceived ease of use. According to Davis (Davis), perceived usefulness refers to "the degree to which a person believes that using a particular system would enhance his or her task performance", while perceived ease of use refers to "the degree to which a person believes that using a particular system would be free of effort". External dimensions, namely,

social, cultural, and political factors further affect these two factors (Echchabi, Al-Hajri, and Tanas, 2019)

***The TAM models the causal relationships between:***

- i. Behavioral intention to use technology (BIU), which is an indicator of the factors affecting the desired behavior (e.g., use of computers). It also specifies how much effort an individual is willing to put in order to perform this behavior (Ajzen and Fishbein, 1980).
- ii. Attitude toward use (ATU), which refers to the degree to which a user likes or dislikes using a certain technological tool (Ajzen and Fishbein, 1977).
- iii. Perceived ease of use (PEU), which refers to the degree to which a person believes that the use of the given tool will be free of effort (Davis, Bagozzi, and Warshaw, 1989).
- iv. Perceived usefulness (Chilakpu), which refers to the extent to which a person believes that using this particular tool would enhance his/her job productivity and performance (Davis et al., 1989).

**Behavioral intention (Echchabi et al.)**

This is a proxy measure for behavior. It represents a person's motivation in the sense of her or his conscious plan or decision to perform certain behavior (Conner and Armitage, 1998), (Chao, 2019), (Ratnasari, Gunawan, Septiarini, Fitriasia, Sylva, Kirana, and Kusuma, 2020). Generally, the strong the intention is, the more likely the behavior performed.

**Subjective norm (Ritchie, Snelgrove-clarke, and Murphy)**

This refers to the belief about whether significant others think he or she will perform the behavior. It relates to a person's perception of the social environment surrounding the behavior.

**Perceived Behavioral Control (PBC)**

This refers to the individual's perception of the extent to which performance of the behavior is easy or difficult (Ajzen, 1991). It increases when individuals perceive they have more resources and confidence (Ajzen, 1985); (Hartwick and Barki, 1994); (Lee and Kozar, 2005).

The Theory of Reasoned Action (Bebetsos et al.) (Ajzen and Fishbein, 1980) hypothesized that human actions explained and based on the relationship between pre-existing attitudes and behavioral intentions. This theory gave birth to a number of models that all seek to explain one's intention to use technology. Among them, the Technology Acceptance Model (TAM), validated and widely used (Davis et al., 1989).

**RESEARCH HYPOTHESIS**

The hypotheses for the study formulated as thus:

H1 there is a positive relationship between Attitude and Behavioural Intention to Practice

H2 there is a positive relationship between Perceived Behavioural Control and Behavioural Intention to Practice

H3 there is a positive relationship between Perceived Ease of Survey Practice and Attitude towards practice

H4 there is a positive relationship between Perceived Usefulness of Practice and Attitude towards practice

H5 there is a positive relationship between Self-Efficacy and Perceived Behavioural Control

H6 there is a positive relationship between Subjective Norms and Perceived Behavioural Control

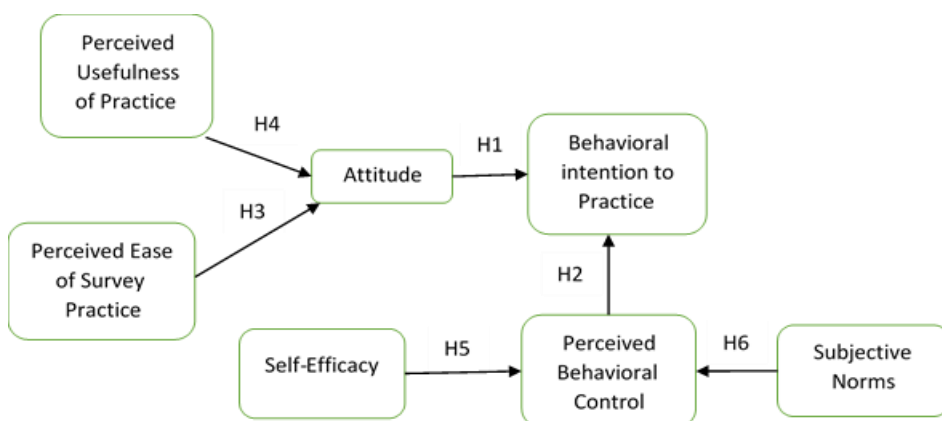

Figure 1 – Conceptual Model

## RESEARCH METHODS

The data used are responses from electronic questionnaires distributed online through google form to targeted audience. Majority of the forms were transmitted randomly and repeatedly because rejections it faced by private practitioners. Hence, number of distribution not directly analyzed.

The research targeted surveying professionals in Nigeria with major reference to Ogun, Lagos and Oyo states. In this study, stratified random sampling was technique used to administer the questionnaire. Subsequently, only 84 copies of questionnaire. A sampling method suggested that the minimum required sample size depends on the maximum number of arrows pointing to a latent variable as specified in the structural equation model (Macrolides & Saunders, 2006); Wolf, Harrington and Miller (2013). Sekaran, (2003) also opined that a purposive sampling method be utilised when the samples collected are based on certain considerations and several criteria. Therefore, sample size adopted with a minimum number of ninety-one respondents has six number of arrows pointing at the Behavioural Intention to Practice, but eighty-four were responses found usable. This is at 95% confidence interval and an alpha level of 5% returned (Victor, Thoppan, Nathan and Maria, 2018).

## ANALYSIS, RESULTS AND DISCUSSION

The structured responses were to fit the input format of the analytic tool of the data processing software.

The measurement (Outer) and structural (inner) models were analysed using SmartPLS 3, a variance-based Structural Equation Modelling Software through Partial Least Squares (PLS).

**Table 1 Significance level, composite reliability results and validity**

Construct Indicators	Ldgs	$\alpha$	AVE
Perceived Usefulness of Practice	PUP	0.966	0.855
PUP1. Survey Practice can improve my professional career.	0.911		
PUP2. Engaging in Survey Practice increases my job performance.	0.939		
PUP3. Private practice will open new professional areas for me	0.926		
PUP4. Practicing can allow me to do more interesting and imaginative work with more productivity.	0.928		
PUP5. Frequent survey tasks will enhance the effectiveness of my professional practice.	0.928		
PUP6. Overall, I find the survey practice important for my career.	0.915		
Perceived Ease of Survey Practice	PSP	0.902	0.718
PSP1. It would be easy for me to become an expert when I engage in survey practices.	0.901		
PSP2. Practicing will make me a smarter practitioner.	0.926		
PSP3. It will be easy to summon the pressures in survey practice	0.766		
PSP4. I would make less error due to my years of experience in survey practice.	0.831		
PSP6. I will find it easy to corroborate existing principles of survey practice.	0.804		
Attitude of Practitioners	ATP	0.863	0.879
ATP4 I have a positive attitude towards Survey Practice	0.925		
ATP5 I think survey practice is good for my work experience.	0.949		
Behavioural Intention to Practice	BIP	0.929	0.825
BIP2 I will definitely love to practice surveying whenever I chance to do so	0.871		
BIP3 I intend to [or continue using] practice when the policy allows it.	0.896		
BIP4 I intend to use my seal for upcoming jobs.	0.923		
BIP5 I plan to use engage in survey practice as soon as possible	0.941		
BIP6 Assuming I had access to practice, I will definitely love to	0.871		
Subjective Norms	SN	0.895	0.705
SN1 It is pleasing if the extant policies are regulated to allow lecturers to practice	0.864		
SN2 Current or potential employers would allow the lecturers to engage in professional practice.	0.832		
SN3 Current or potential clients would prefer of survey practice of lecturers	0.780		
SN4 The services of the survey lecturers will improve when they engage in professional practice	0.876		
SN5 If lecturers practice, they will impart more field experience on the trainees.	0.843		
Perceived Behavioural Control	PBC	0.892	0.699
PBC2 My office has a good grasp of new functions of survey practice.	0.901		
PBC3 My office has enough income to own survey-practicing firm.	0.926		
BC4 My office could deal with any survey practice.	0.766		
PBC5 The volume of the survey task influences my decision to engage survey practice.	0.831		
PBC6 I will be able to manage my time for other duties aside survey practice.	0.804		
Self-Efficacy	SE	0.928	0.738
SE1 I know quite well the reasons I will subscribe to survey practice.	0.826		
SE2 I am capable of any survey practice	0.919		
SE3 I am able in making good survey practice	0.912		
SE4 I can make use of Computer Aided Drafting and design for my survey works	0.868		
SE5 I have new survey equipment that would enhance my survey tasks	0.760		
SE6 I am versatile with Survey Practice	0.858		



For the measurement model, three (3) evaluation criteria are employed namely; the significance level of factor loadings of all the items, the composite reliability which should not be less than 0.7 and also the Average variance extracted (Godin, Bélanger-Gravel, Eccles, and Grimshaw) which should be 0.5 and above. The results shows that the variables used in the questionnaire is adequate and reliable. The Cronbach alpha ranges from 0.7 to 0.9. This surpassed the widely accepted value of 0.60 or greater in social sciences research (Pallant, 2010; Field, (2013), Awolesi (2019), (Rachbini, 2018).

**Validity and reliability test results**

A Cronbach alpha less than 0.5 is assumed to be unreliable while a Cronbach alpha value of 0.5 and above is assumed to be reliable. However, the closer the Cronbach alpha value to one, the more reliable the data set. Each construct in this study has alpha of >0.7, which means all the constructs reliable. Another result is the factor loadings in table 1 above shows that all the measuring indicators sufficiently explains the variable they measured.

**Model fit evaluation**

An extract of its window shown in Figure 2. To evaluate the model fit, the standardized root mean square residuals (SRMR) was used to measure approximate fit of the theory (Yahaya et al 2019). Models can yield SRMR values higher than 0.05 (Henseler, et al., 2014). Therefore, a cut-off value of less than 0.08 adopted as proposed by Hu & Bentler, (1999). The fit summary of the study is 0.082 as shown in table 2

**Table 2 Model fit summary**

	Saturated Model	Estimated Model
SRMR	0.082	0.103
d_ULS	3.735	5.913
d_G	2.494	2.747
Chi-Square	975.704	1010.510
NFI	0.710	0.700

**Table 3 Coefficient of determination**

R Square	R Square	R Square Adjusted
ATP	0.413	0.399
BIU	0.639	0.630
PBC	0.731	0.724

The coefficient of determination R2 measures the predictive power of the model, it is explains variance in endogenous construct from exogenous constructs connected to it (Hair, Hult, Ringle, & Sarstedt, 2017). The R2 value of Attitude is 0.413 (41%) regarded as low, Behavioral Intention to Practice is 0.638 (64%) moderate and Perceived Behavioral Control is 0.731 (73%) considered high impact relationship.

**Table 4 Effect size**

F Square	ATP	BIP	PBC
ATP		0.359	
BIP			
PBC		0.446	
PSP	0.013		
PUP	0.224		
SE			1.638
SN			0.020

**Effect sizes (F2)**

The effect size F2 have values classified into ranges of 0.02 as small, 0.15 as medium and 0.35 as large (Samar et al 2018). Path PSP-ATP and SN-PBC are in the small region, while PUP-ATP is in the medium and others ATP-BIP, PBC-BIP and SE-PBC are the over-effect regions.

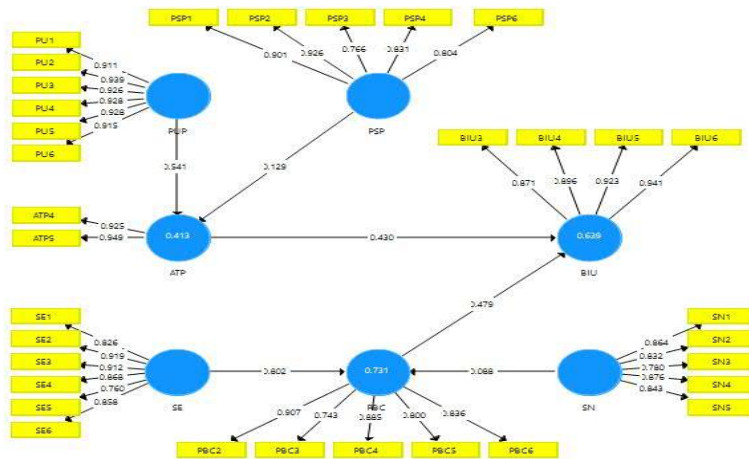

Figure 2 Measurement model

**Table 3: Hypothesis test results**

H0		Original Sample (O)	Sample Mean (M)	Standard Deviation (STDEV)	T Statistics ( O/STDEV)	P Values	Significance
H1	ATP -> BIP	0.430	0.438	0.100	4.277	0.000	Significant
H2	PBC -> BIP	0.479	0.473	0.111	4.301	0.000	Significant
H3	PSP -> ATP	0.129	0.131	0.159	0.813	0.416	Not Significant
H4	PUP -> ATP	0.541	0.544	0.147	3.684	0.000	Significant
H5	SE -> PBC	0.802	0.797	0.060	13.399	0.000	Significant
H6	SN -> PBC	0.088	0.095	0.063	1.405	0.160	Not Significant

Out of six hypotheses tested, four hypotheses were significant (accepted) while two were not significant (rejected). Attitude and Perceived Behavioural Control have proven to be strong variables to measure human intention. Although, Perceived Usefulness and Self-Efficacy acted as boosters to Attitude and Perceived Behavioural Control respectively, it is important to identify the significance level of Self-Efficacy on Perceived Behavioural Control as shown by the effect size.

Perceived Ease of Survey Practice is weak in measuring Attitude has shown in the result above, therefore, a critical evaluation can still be carried out in further researches to explore other factors that defines intention. H1 shows high impact of

attitude on behavioural intention to practice, H2 also has high impact variable perceived behavioural control on behavioural intention to survey practice. High impact was recorded for H4 and H5, but H3 and H6 are not significant to the latent construct they measured in the study, therefore, they were rejected. The main aim of the study to show the relationship of attitude and self-efficacy in perceived behavioural control on behaviour modelled successfully with evidences and supports shown by different categories of test and models.

## CONCLUSION

The evaluations, estimations and weights used to measure the factors that affects intention and perception, the relationship between intention and perception and the research model have shown to be valid and acceptable. This study has revealed the role of main constructs (attitude and perceived behavioral control) in human behavior and also the relationship between these constructs and other variables such as perceived ease of survey practice, perceived usefulness, self-efficacy and normative norms in model. This further explains that there is a certain level of knowledge and expertise required for surveying practice. It is important to note self-efficacy is a very strong indicator to perceived behavioral control that leads to actual behavioral intention.

## REFERENCES

- Ajzen, I. (1985). From Intentions To Action: A Theory of Planned Behavior. In Action Control ((Eds.), B. Ed.). Berlin, Heidelberg: Springer-Verlag.
- Ajzen, I. (1991). The Theory of Planned Behavior. *Organizational Behavior and Human Decision Processes*, 50(2), 179-211. doi:[https://doi.org/10.1016/0749-5978\(91\)90020-T](https://doi.org/10.1016/0749-5978(91)90020-T)
- Ajzen, I. & Fishbein, M. (1977). Attitude-Behavior Relations: A Theoretical Analysis and Review of Empirical Research. *Psychol Bull*, 84, 888-918.
- Ajzen, I. & Fishbein, M. (1980). *Understanding Attitudes and Predicting Social Behavior* (Hall, P.-. Ed.). NJ: Englewood Cliffs.
- Akinola, G. & Ojo, G. (2014). Survey Professional Ethics in Nigeria – On a Downward Spin? Paper presented at the FIG Congress 2014, Kuala Lumpur, Malaysia.
- Bebetsos, E., Derri, V., Zafeiriadis, S. and Kyrgiridis, P. (2013). Relationship among Students' Attitudes, Intentions and Behaviors towards the Inclusion of Peers with Disabilities, in Mainstream Physical Education Classes. *International Electronic Journal of Elementary Education*, 5, 233-248.
- Cascio, C., Dal Lin, S. & Falk, E. (2013). *Health Communications: Predicting Behavior Change from the Brain* (Hall, P. Ed.). New York: Springer.
- Chao, C. (2019). Factors Determining the Behavioral Intention to Use Mobile Learning: An Application and Extension of the UTAUT Model. *Frontiers in Psychology*, 10, 1652.
- Chilakpu, K. (2018). Determination of Appropriate Pressing Pressure For Selected Sacks Used In Cassava Pulp Dewatering. *Nigerian Journal of Technology*, 37, 795. doi:10.4314/njt.v37i3.31
- Conner, M. & Armitage, C. (1998). Extending the Theory of Planned Behavior: A Review and Avenues for Further Research. *Journal of applied social psychology*, 28, 1429-1464.

- Davis, F. D. (1989). Perceived Usefulness, Perceived Ease of Use, and User Acceptance of Information Technology. *MIS quarterly*, 13, 319. doi:10.2307/249008
- Davis, F. D., Bagozzi, R. P. & Warshaw, P. (1989). User Acceptance of Computer Technology: A Comparison of Two Theoretical Models. *Management Science*, 35, 982-1003. doi:10.1287/mnsc.35.8.982
- Echchabi, A., Al-Hajri, S. and Tanas, I. (2019). Analysis of E-Banking Acceptance in Oman: The Case of Islamic Banks 'Customers. *International Journal of Islamic Economics and Finance (IJIEF)*, 1. doi:10.18196/ijief.128
- Fajemirokun, F. A. (2006, August 23-25). Geodesy in Nigeria – Past, Present and Future. Paper presented at the Proceedings of the Nigerian Association of Geodesy Conference, University of Lagos, Nigeria.
- Glasman, L. R. & Albarracín, D. (2006). Forming Attitudes that Predict Future Behavior: a Meta-Analysis of the Attitude-Behavior Relation. *Psychol Bull*, 132(5), 778-822. doi:10.1037/0033-2909.132.5.778
- Godin, G., Bélanger-Gravel, A., Eccles, M. and Grimshaw, J. (2008). Healthcare Professionals' Intentions and Behaviours: A systematic Review of Studies Based on Social Cognitive Theories. *Implementation Science*, 3(1), 36. doi:10.1186/1748-5908-3-36
- Grun, A. (1998). Geomatic Engineering and Environmental Engineering. *Geomatics Information Magazine (GIM)*, 12, 30-33.
- Hartwick, J. & Barki, H. (1994). Explaining the role of use participation in information system use. *Management Science*, 40(4), 440–465.
- Jatau, B., Fernandes, R. M. S., Adebomehin, A. & Gonçalves, N. (2010, 11-16, April). NIGNET – The New Permanent GNSS Network of Nigeria. Paper presented at the FIG Congress, Sydney, Australia.
- Larson, M. (1977). *The Rise of Professionalism: A Sociological Analysis*.
- Lee, Y. & Kozar, K. (2005). Investigating Factors Affecting The Anti-Spyware System Adoption. *Communications of the ACM*, 48(8), 72–77.
- Ratnasari, R., Gunawan, T., Septiarini, S., Fitriasia, D., Sylva, R., Kirana, A. & Kusuma, C. (2020). Customer Satisfaction Between Perceptions of Environment Destination Brand and Behavioural Intention. *International Journal of Innovation, Creativity and Change*, 10(12).
- RICS. (2014). *Maintaining Professional And Ethical Standards*. <http://www.rics.org/site/>
- Ritchie, K., Snelgrove-clarke, E. & Murphy, A. (2018). The 23-item Evidence Based Practice-Knowledge Attitudes and Practices (23-item EBP-KAP) Survey: Initial validation among Health Professional Students. *Health Professions Education*, 5. doi:10.1016/j.hpe.2018.09.004
- Sekaran, U. (2003). *Research Methods for Business - A Skill Building Approach (4th ed.)*. John Wiley and Sons, Inc.
- Sharma, A. (1997). Professional as Agent: Knowledge Asymmetry in Agency Exchange. *Academy of Management Review*, 22, 758-798.
- Thompson, F. M. L. (1968). *Chartered Surveyors: The growth of a profession*. London: Routledge and Kegan Paul.



# THE ROLE OF SAFETY ATTITUDE IN CHANGING SAFETY BEHAVIOUR AND HAZARD RECOGNITION CAPABILITY OF CONSTRUCTION WORKERS

Bello Mahmud Zailani<sup>1</sup>, Mu'awiya Abubakar<sup>2</sup> and Yahaya Makarfi Ibrahim<sup>3</sup>

<sup>1,2</sup>*Department of Building, Ahmadu Bello University, Nigeria*

<sup>3</sup>*Department of Quantity Surveying, Ahmadu Bello University, Nigeria*

Worker's safety has been a major concern in the successful execution of various construction activities. Workers that are unable to recognise the active, emerging, or latent hazards, in the work environment are often exposed to safety risks, leading to catastrophic accidents and injuries. Despite research efforts on strategies to improve the safety of workers on construction sites, recent studies have reported the apparent disregard for human-related factors in the formulation of safety strategies which limits their effectiveness. In this regard, this study provides insight on the specific role worker's safety attitude plays on safety behaviour towards improving Hazard Recognition Capability (HRC) of the worker. A quantitative research approach was adopted for the study, using a structured questionnaire to collect both ordinal and nominal data. Both descriptive and inferential statistical tools were used to analyse the data. Spearman's correlational analysis technique was used to ascertain the monotonic relationship between worker's safety attitude, safety behaviour, and hazard recognition capability. Findings of the study show that worker's safety attitude has an influence on worker's safety behaviour on the job site, although no relationship was established between worker's safety behaviour and respective hazard recognition capability. This finding provides an empirical evidence on the fractional relationship between safety behaviour and HRC. Thus, it is recommended that other human-related factors be studied in relation to the area of safety management with a view to find a sustainable solution to the abysmal safety performance of the global construction industry.

Keywords: attitude, behaviour, construction industry, hazard recognition, safety

## INTRODUCTION

The construction industry has been identified as one of the most dangerous industries, recording high rate of accidents and fatality (Tam & Fung, 2012; Törner & Pousette, 2009). According to International Labour Organisation (ILO, 2005), about 16% of fatal accidents recorded at work occurs on construction sites.

<sup>1</sup> bellomahmud34@gmail.com; +2348032987321

<sup>2</sup> muawiyaabubakar1@gmail.com

<sup>3</sup> makarfi@gmail.com

Relatedly, census data from the Bureau of Labour Statistics showed that 774 recorded fatality cases were from construction site injuries in the year 2010. This fretting data emphasises the urgent need to devise safety management strategies, and hazard control mechanisms that will improve the safety performance of the industry. In this regard, Zhou, Goh and Li (2015) noted the increasing number of academic studies around the globe, focused on devising novel approaches and techniques to key safety related issues such as safety climate, accident statistics, design for safety, and safety culture.

Despite this surge in academic and professional efforts towards curbing the safety issues in the construction industry, there has been very little improvement on the safety performance of the industry (Namian et al., 2016b). A major deficiency of these efforts has been noted to be the almost complete overlook of human-related factors in the design of safety management systems (Abubakar et al., 2020). Due to the dynamic and unique nature of construction operations, the design of generic safety management systems and techniques are ineffective in addressing safety challenges in all contexts (Dekker, 2012). Choudhry, Fang and Ahmed (2008) argued that workplace safety is a complex phenomenon, and the management of the human element in construction industry is even more complex. Moreover, safety cannot be guaranteed by legislation or regulations alone, as there is apparent need for workers and employees to also commit themselves to safety practices (Baig, 2001).

In line with the aforementioned deficiencies, recent studies in construction safety management have begun to look at the inherent factors that limit the safety performance of construction workers (Abubakar et al., 2020; Namian et al., 2016b). Hazard recognition capability of workers has been identified as a fundamental requirement for addressing the health and safety challenges encountered on construction sites (Abubakar et al., 2020; Albert et al., 2014). Construction site accidents have been found to be mainly caused by worker's unsafe behaviours, largely due to nonchalant attitude towards safety hazards (Fang & Wu, 2013; Feng, 2015). Workers often tend to underestimate safety risks on construction site, which limits their ability to identify hazardous situations (Pandit et al., 2019). Chen, Golparvar-Fard and Kleiner (2014) defined the concept of Hazard recognition as the ability of managers and workers to sense, analyse, and extract physical or mental stimuli that indicates the existence of a hazardous situation in a complex and dynamic scenario of construction environments. These hazardous situations often when not recognised and managed lead to unsavoury safety incidences and fatalities in construction.

Abubakar et al. (2020) classified the key factors influencing hazard recognition capability of construction workers into four distinct taxonomies (personal, organisational, social, and project), towards developing context-based strategies for improving the safety performance of the construction industry. The study established a significant influence of workers personal attributes on respective hazard recognition capability. However, with a view to fill the gap in literature on human-related safety studies and strategies for improving safety performance of construction workers, this study builds on the findings of Abubakar et al. (2020) by providing insight into the dynamics of worker's safety attitude which is an antecedent of personal factors, influencing safety behaviour and hazard

recognition capability of workers. Notably, Choudhry, Fang and Ahmed (2008) noted that the subject of worker's attitudes and its relation to safety performance in construction industry is complex. However, as attitude is a core manifestation of inherent individual traits which reflects on characteristics and behaviour (Beus et al., 2015), this study provides an answer to this research question "Does worker's safety attitude have influence on safety behaviour and hazard recognition capability of the worker?".

## LITERATURE REVIEW

### **Safety attitude, behaviour and HRC**

The definition of Attitude in literature is quite vague and dynamic. Sawacha (1993) observed that the definition often depends on the context of the discourse, and the observables selected as the basis for inference. Despite the concept of attitude being seen as an abstraction or a hypothetical construct rather than an actual principle, Sartain et al. (1974) defined it as the tendency of an individual to react positively or negatively towards an object or a person. Katz (1960) has described attitude as the predisposition of the individual to evaluate some symbol or object, or aspect of the world in a favourable or unfavourable manner". The concept of Safety Attitude could then be seen as complex and multidimensional with deep roots in fields such as safety science, psychology and management science.

More so, as human behaviour is a clear manifestation of attitudes and beliefs, social and psychological dynamics of workers may have a strong influence on their safety behaviour on construction sites ( Choudhry, 2014; Krech & Crutchfield, 1948). Lingard and Turner (2017) found that embracing of healthy behaviours by workers is influenced by factors playing around the individual. Leung, Chan and Yuen (2010) showed that safety cases and risky behaviours can be affected by the safety attitudes of construction workers.

More often, workplace accidents comprise the failure of workers to identify a hazardous condition. Studies have reported that more than 42% of injuries in construction occur because of inadequate hazard recognition and evaluation (Haslam et al., 2005; Sacks et al., 2013). Zhou and Ding (2017) observed that workers found themselves in a position of risk either due to their ignorance or inability to behave safely. Although their ignorance may be linked to limited knowledge and experience, their attitude towards safety may inform their unsafe behaviour.

Based on the forgone, it can be hypothesised that worker's safety attitude as a corresponding effect on the worker's behaviour towards safety, and the respective ability to recognise hazards on job site. This assumption is driven on the psychological theoretical base of the planned behaviour theory which links human beliefs to respective behaviour. Ajzen & Fishbein (1975) noted that an individual's belief and attitude towards a certain phenomenon commensurate with the individual's tendency to behave positively or negatively. Pandit et al. (2019) noted that worker's nonchalant belief towards safety risk often result in risk-taking behaviour and the normalisation of deviance from safe-work operations. For instance, Perlman et al. (2014) observed the behaviour of worker's that are commonly used to using ladders as a job routine to become increasingly insensitive to the risk of falls even in circumstances where the potential of fall is

recognised as a relevant hazard. This is also common amongst workers working in other distinct job trades (Bohm & Harris, 2010; Choudhry & Fang, 2008)

### Measuring attitude and behaviour

Several methods and techniques have been adopted across various literatures for the measurement of individual attitude in diverse contexts (Johnson & Scott, 1965). Green, (1954) classified these methods into six major categories namely Judgement Method, the Summated Ratings methods, the Scalogram Analysis method, the Rating Method, the Unfolding Technique and the Latent Structure Analysis method. The structure of the safety behaviour scale designed by Hayes et al. (1998) was adapted to fit the context of this study in measuring the safety behaviour of construction workers on site, sourcing the measurement items from specific construction related literature. Table 1 highlights the respective measurement items for both constructs.

**Table 1: Measurement items**

SN	Measurement Items (Safety Attitude)	Source
1	Provision of PPE and other safety tools on construction site is an unnecessary effort.	(Abubakar et al., 2020; Gao et al., 2020)
2	Pressure from other workers and supervisors on site makes me behave unsafely.	(Gao et al., 2020; Wu et al., 2017)
3	I can never be involved in an accident because of my vast experience on the job.	(Abubakar et al., 2020; Pandit et al., 2019; Sacks et al., 2013; Sawacha, 1993)
4	My workmate's safety on site is not very much important to me.	(Sawacha, 1993)
5	Safety Training prior to commencement of work is unnecessary.	(Namian et al., 2016b; Sawacha, 1993)
6	I am safety conscious on site only when I know management is strict on it.	(Sawacha, 1993)
7	I will rather finish my work early discarding safety, than follow safety protocols that takes longer time to finish.	(Pandit et al., 2019)
8	I do not follow safety rules that I feel are unnecessary.	(Gao et al., 2020)
SN	Measurement Items (Safety Behavior)	Source
1	I take drugs while on site to enable me work harder.	(Abubakar et al., 2020)
2	While working, I get overwhelmed that i become unaware of my environment.	(Abubakar et al., 2020; Hayes et al., 1998)
3	I barely wear PPE or use other safety tools while on site.	(Gao et al., 2020; Hayes et al., 1998)
4	I sometimes breach safety protocols in order to finish my work on time.	(Abubakar et al., 2020; Gao et al., 2020; Hayes et al., 1998; Pandit et al., 2019)
5	I hardly check the conditions of my tools and site equipment before I use them.	(Gao et al., 2020; Hayes et al., 1998)
6	I sometimes engage in hazardous works even when I know my safety is not guaranteed.	(Sawacha, 1993)
7	I do not always stick to my workstation as I like to wander around the site.	(Sawacha, 1993)
8	I do engage in works on site that I had no prior training on because I feel they are easy to do.	(Gao et al., 2020; Sawacha, 1993)



## METHODOLOGY

A Quantitative research approach was adopted for the study, using a questionnaire as research instrument. The population of the study included workers on 3 selected construction sites in Kaduna state, Nigeria. The choice of the city and construction sites were at the convenience of the researcher as Burnett and Holton (1997) noted one of the advantages of quantitative research methods is their ability to use relatively smaller convenient sample size to make inferences about larger populations that would be prohibitively overwhelming to study. The demography of the workers involved in carpentry, masonry, plumbing and electrical works were purposively selected due to the hazardous nature of such tasks (Davies & Tomasin, 1996). Overall, a total of 30 workers that fit the study demography were identified, and all agreed to participate in the study. However, 3 responses were discarded due to errors in filling the research instrument.

The summated ratings method developed by Likert (1932) was used to measure respondent's safety attitude and behaviour on site. The scale used in this study was initially subjected to both academic and professional scrutiny to ascertain its validity and reliability. Adaptations were made from the initial scale based on the outcome of the validity exercise, and the resulting scale recorded a reliability value ( $\alpha=0.90$ ) which shows strong of reliability (Cronbach, 1951). Respondents were then asked to respond with their respective level of agreement to each item using a scale of 1-5 (1= strongly disagree, 2= disagree, 3= somewhat agree, 4= agree, 5=strongly agree). Subsequently, an average score across all measurement items for individual worker was calculated using Eq. (1) and Eq. (2). This gives an aggregated safety attitude and safety behaviour scores for each worker ranging from 1-5, with positive score and negative score at both extremes (1= Positive, 5= Negative) considering the negative structure of the measurement items.

$$SA_{worker} = \frac{\sum_1^8 SA}{8} \dots\dots\dots(1)$$

$$SB_{worker} = \frac{\sum_1^8 SB}{8} \dots\dots\dots(2)$$

where  $SA_{worker}$  is a measure of the safety attitude of an individual worker,  $SB_{worker}$  is a measure of behaviour of individual worker, SA and SB are the responses of individual workers to each of the survey statement items for safety attitude and safety behaviour respectively.

Relatedly, the Hazard recognition capability of the workers was assessed using pictures capturing a total of 8 common hazards often encountered on construction sites. These hazards included Using ladder horizontally, working at height without harness, scattered tools on the floor, working close to electric lines without harness, misuse of PPE, hanging out of a window to work, working in extreme weather condition, and working in confined spaces. Respondents were required to look through, and identify the hazards from respective pictures. This technique according to Han et al. (2020) is an effective method in accessing hazard recognition capability of individuals in diverse work contexts. The hazard recognition capability of each worker was calculated using Eq. (3).

$$HRC = \frac{HazardRecognized}{TotalHazard} \times 100 \dots\dots\dots(3)$$

## DATA ANALYSIS AND RESULTS

### Demography of respondents

The characteristic nature of the study respondents, which puts the findings of the study into relative context was defined using questions that inquired about the respective demography of the respondents. Table 2 shows that Masons and Carpenters formed 74% of the total respondents with 37% representation respectively. Whereas, 26% of the respondents were involved in mechanical and electrical works. More so, with regards to the years of experience in respective jobs, majority of the workers representing 57% of the respondents reported having work experience ranging from 6 to 15 years, 30% having over 16 years of experience, whilst only 15% reported having 1 to 5 years of experience.

**Table 2: Job demography**

Nature of Job	Frequency	Percentage (%)	Years of Experience	Frequency	Percentage (%)
Carpentry	10	37	1-5years	4	15
Masonry	10	37	6-15years	15	56
M&E	7	26	16years and above	8	30
Total	27	100	Total	27	100

Namian, Albert, Zuluaga and Behm (2016) noted the significant role safety training Programmes play in orienting construction workers on safety. Along this line, this study enquired about the prior engagement of the respondents in related safety trainings on respective job tasks.

**Table 3: Accident experience**

Prior Accident	Frequency	Percentage (%)	Severity	Frequency	Percentage (%)
Yes	26	96	Not Severe	9	33
No	1	4	Severe	12	44
	27	100	Very Severe	6	22
			Total	27	100
Nature of Accident	Frequency	Prior Training	Frequency	Percentage (%)	
Electrocution	2	Yes	20	74	
Stepping on Sharp Object	2	No	7	26	
Fall from Height	18				
Fall into an Open Pit	1				
Falling Objects	3				
Chainsaw Cut	1				

Findings presented in Table 3 showed that 74% of the respondents have had prior safety training on their respective job tasks, with only 26% responding negatively

to the question. Relatedly, Gharibi et al. (2008) observed that workers who have been previously involved in a job-related accident, or have witnessed the occurrence of an accident, are often more safety cautious when on site. A vast majority of the respondents representing 96% have had an accident experience on job site, with "Fall from Height" being the most frequent nature of accident experienced as shown in Table 3. Other types of accident noted by the respondents include Electrocution, Stepping on Sharp Object, fall into an Open Pit, Falling Objects, and Chainsaw Cut. More so, 22% of these accidents were reported to be fatal, 44% resulted into major injuries, while only 33% resulted into minor injuries.

### **Safety attitude, behaviour and hazard recognition capability of workers**

As discussed in the methodology section, an aggregated score was calculated for workers safety attitude and behaviour respectively, based on responses to the measurement items presented in the questionnaire. Analysis of the data shows workers having a relatively positive attitude towards safety in their respective job tasks, with an aggregated mean value of 2.43 across all the 27 workers. More so, the one sample T-test showed that the mean value is significantly distant from the T-value ( $t=3$ ,  $p<0.05$ ) being the threshold for negative safety attitude. Relatedly, the aggregated score of 2.44 for safety behaviour across all the workers shows a relatively good safety behaviour on job site, which is also significantly different from the T-Value ( $t=3$ ,  $p<0.05$ ).

The hazard recognition capability as a measure of the ability of a worker to identify potential risks and hazards that could result in job site accident was measured as a function of percentage. Collectively, all 27 construction workers were only able to Identify an average 49% of the total hazards presented in the image with over 50% of the hazards unidentified. It is also important to note that the deviation between the scores of respective workers was statistically quite minimal ( $std=0.18$ ) with only a few workers scoring very high, and very low marks respectively.

Ultimately, to achieve the aim of this study, a correlation analysis was conducted to scientifically ascertain the relationship between worker's safety attitude, safety behaviour, and respective hazard recognition capability on work site. Due to the nature of data collected, the Spearman's non-parametric correlation technique was used to test the relationships at 95% confidence level. Result of the analysis presented in Table 4 shows a non-significant weak association between worker's attitude towards safety, and the respective capability to recognise hazard on job site ( $r_s=0.10$ ,  $P>0.05$ ). More so, Although Liao, Sun and Zhang (2021) noted that different types of hazards can induce different cognitive demands which manifests into individual behaviours, no correlation was found between worker's safety behaviour and hazard recognition capability of the worker in respective job site ( $r_s= -0.147$ ), with the correlation also being not statistically significant ( $P>0.05$ ).

**Table 4: Spearman's Correlation Between HRC, Attitude and Behaviour**

	HRC	Safety Attitude	Safety Behavior
HRC	1	0.10 ( $P=0.77$ )	-0.147 ( $P=0.47$ )
Safety Attitude	0.10 ( $P=0.77$ )	1	0.69 ( $P=0.00$ )
Safety Behavior	-0.147 ( $P=0.47$ )	0.69 ( $P=0.00$ )***	1

\*\*\* Significant at 95% Confidence Level

The result of the correlation analysis provides a scientific answer to the research question in this study. A significantly strong association was found between worker's safety attitude and safety behaviour on respective job site ( $r_s=0.69$ ,  $p>0.00$ ), although the partial association between positive safety attitude and hazard recognition capability was found not to be significant ( $r_s=0.1$ ,  $p>0.77$ ). It is paramount to note that the significance level of the Spearman's correlation does not mean to disregard the association, but rather limits its reliability and application in a broader context (Schober et al., 2018). Therefore, it can be claimed that a positive change in worker's safety attitude does not influence any significant improvement on the hazard recognition capability of the worker, but rather improves the worker's safety behaviour in dynamic safety climates. As Pandit et al. (2019) observed that providing a positive safety climate improves hazard recognition capability of construction workers, and safety risk perception which is a manifestation of safety attitude, it can be seen that safety attitude is not a stand-alone factor in changing hazard recognition capability of construction workers. This is in line with the views of previous literature focused on understanding the antecedents of worker's hazard recognition capability on respective job sites (Abubakar et al., 2020; Albert et al., 2017; Namian et al., 2016a).

## CONCLUSION AND RECOMMENDATION

The fretting nature of the construction industry with regards to safety of workers, and the execution of tasks begs the need for an urgent response. Building on the numerous efforts from studies in this regard, this paper provides a new perspective to the management of construction safety on construction sites by focusing on the human related dynamics of the worker. Understanding the antecedents of worker's safety hazard recognition capability certainly has the potential of minimising the occurrences of avoidable accidents, and improving the overall safety performance of the industry. This study found that although safety attitude was found to influence safety behaviour of workers with slight impact on hazard recognition capability, the behaviour of worker with regards to safety has no direct correlation with the capability of the worker to identify hazardous working circumstances. This finding prompts a different outlook to the relationship on the role of safety attitude in changing behaviour and improving hazard recognition capability. It could be probable that safety behaviour of worker plays a facilitating role between safety attitude and hazard recognition capability. As thus, it is recommended that further studies be carried out in divergent demographic and statistical contexts to put this relationship into clearer perspective.

## REFERENCES

- Abubakar, M., Ibrahim, Y. M., Bala, K., & Ibrahim, A. D. (2020). Identifying the Factors Influencing Hazard Recognition Capability of Construction Workers. *Construction Research Congress 2020*, 268–278.
- Ajzen, I., & Fishbein, M. (1975). A Bayesian analysis of attribution processes. *Psychological Bulletin*.
- Albert, A., Hallowell, M. R., Kleiner, B., Chen, A., & Golparvar-Fard, M. (2014). Enhancing Construction Hazard Recognition with High-Fidelity Augmented Virtuality. *Journal of Construction Engineering and Management*, 140(7), 04014024.

- Albert, A., Hallowell, M. R., Skaggs, M., & Kleiner, B. (2017). Empirical measurement and improvement of hazard recognition skill. *Safety Science*, 93, 1–8.
- Baig, M. (2001). Safety assessment of industrial construction projects in Saudi Arabia [King Fahad University of Petroleum and Minerals].
- Beus, J., Dhanani, L., & McCord, M. (2015). A meta-analysis of personality and workplace safety: Addressing unanswered questions. *Journal of Applied Psychology*.
- Bohm, J., & Harris, D. (2010). Risk Perception and Risk-Taking Behavior of Construction Site Dumper Drivers. *International Journal of Occupational Safety and Ergonomics*, 16(1), 55–67.
- Burnett, M., & Holton, E. (1997). *Ways of Doing Practical Research: Human Resource Development Research Handbook: Linking Research and Practice*. Berrett-Koehler Publishers.
- Chen, A., Golparvar-Fard, M., & Kleiner, B. (2014). SAVES: An Augmented Virtuality Strategy for Training Construction Hazard Recognition. *Construction Research Congress 2014: Construction in a Global Network*, 2345–2354.
- Choudhry, & Fang. (2008). Why operatives engage in unsafe work behavior: Investigating factors on construction sites Related papers. *Safety Science*.
- Choudhry, R. (2014). Behavior-based safety on construction sites: A case study. *Accident Analysis & Prevention*, 70.
- Choudhry, R., Fang, D., & Ahmed, S. (2008). Safety management in construction: Best practices in Hong Kong. *Journal of Professional Issues in Engineering Education and Practice*, 134(1), 20–32.
- Choudhry, R. M., Fang, D., & Ahmed, S. (2008). Safety Management in Construction: Best Practices in Hong Kong Article in *Journal of Professional Issues in Engineering Education and Practice*. *Journal of Professional Issues in Engineering Education and Practice*, 134(1), 20–32.
- Cronbach, L. (1951). Coefficient Alpha and the Internal Structure of Tests. *Psychometrika*, 16(3), 297–334.
- Davies, V., & Tomasin, K. (1996). *Construction Safety Handbook*.
- Dekker, S. (2012). *Just culture: Balancing safety and accountability*. Ashgate Publishing, Ltd.
- Fang, D., & Wu, H. (2013). Development of a Safety Culture Interaction (SCI) model for construction projects. *Safety Science*, 57, 138–149.
- Feng, Y. (2015). Mathematical models for determining the minimum level of voluntary safety investments for building projects. *Journal of Construction Engineering and Management*, 141(7).
- Gao, Y., González, V. A., & Yiu, T. W. (2020). Exploring the Relationship between Construction Workers 'Personality Traits and Safety Behavior. *Journal of Construction Engineering and Management*, 146(3), 04019111.
- Gharibi, V., Mortazavi, S. B., Jafari, A. J., Malakouti, J., & Abadi, M. B. H. (2008). The Relationship between Workers 'Attitude towards Safety and Occupational Accidents Experience. *International Journal of Occupational Hygiene*, June 2017.
- Green, B. (1954). Attitude Measurement. *Handbook of Psychology*.
- Han, Y., Yin, Z., Zhang, J., Jin, R., & Yang, T. (2020). Eye-Tracking Experimental Study Investigating the Influence Factors of Construction Safety Hazard Recognition. *Journal of Construction Engineering and Management*, 146(8), 04020091.

- Haslam, R. A., Hide, S. A., Gibb, A. G. F., Gyi, D. E., Pavitt, T., Atkinson, S., & Duff, A. R. (2005). Contributing Factors in Construction Accidents. *Applied Ergonomics*, 36, 401–415.
- Hayes, B. E., Perander, J., Smecko, T., & Trask, J. (1998). Measuring Perceptions of Workplace Safety: Development and Validation of the Work Safety Scale. *Journal of Safety Research*, 29, 145–161.
- ILO. (2005). Facts on Safety at Work. [www.ilo.org/safework](http://www.ilo.org/safework)
- Johnson, S. F., & Scott, J. (1965). Attitude Testing Implications for Education, Particularly for Further Education. *Vocational Aspect of Education*, 17(36), 3–14.
- Katz, D. (1960). The functional Approach to the Study of Attitudes. *Public Opinion Quarterly*.
- Krech, D., & Crutchfield, R. (1948). Theory and problems of social psychology.
- Leung, M., Chan, Y.-S., & Yuen, K.-W. (2010). Impacts of Stressors and Stress on the Injury Incidents of Construction Workers in Hong Kong. *Journal of Construction Engineering and Management*, 136(10), 1093–1103.
- Liao, P. C., Sun, X., & Zhang, D. (2021). A multimodal study to measure the cognitive demands of hazard recognition in construction workplaces. *Safety Science*, 133(August 2019), 105010.
- Likert, R. (1932). A technique for the Measurement of Attitudes. *Archives of Psychology*.
- Lingard, H., & Turner, M. (2017). Promoting Construction Workers 'Health: A Multi-Level System Perspective. *Construction Management and Economics*, 35(5), 239–253.
- Namian, M., Albert, A., Zuluaga, C. M., & Behm, M. (2016a). Role of Safety Training: Impact on Hazard Recognition and Safety Risk Perception. *Journal of Construction Engineering and Management*, 142(12), 04016073.
- Namian, M., Albert, A., Zuluaga, C. M., & Behm, M. (2016b). Role of Safety Training: Impact on Hazard Recognition and Safety Risk Perception. *Journal of Construction Engineering and Management*, 142(12), 04016073.
- Pandit, B., Albert, A., Patil, Y., & Al-Bayati, A. J. (2019). Impact of safety climate on hazard recognition and safety risk perception. *Safety Science*, 113(November 2018), 44–53.
- Perlman, A., Sacks, R., & Barak, R. (2014). Hazard recognition and risk perception in construction Need to cite this paper? Want more papers like this? Hazard recognition and risk perception in construction. *Safety Science*.
- Sacks, R., Perlman, A., & Barak, R. (2013). Construction safety training using immersive virtual reality. 31(9), 1005–1017.
- Sawacha, E. O.-O. (1993). An investigation into safety attitudes and safety performance in the construction industry [Brunel University]. In PhD Thesis (Issue December).
- Schober, P., Boer, C., & Schwarte, L. (2018). Correlation coefficients: appropriate use and interpretation. *Anesthesia & Analgesia*, 126(5), 1763–1768.
- Tam, V. W. Y., & Fung, I. W. H. (2012). Behavior, attitude, and perception toward safety culture from mandatory safety training course. *Journal of Professional Issues in Engineering Education and Practice*, 138(3), 207–213.
- Törner, M., & Pousette, A. (2009). Safety in construction—A Comprehensive Description of the Characteristics of High Safety Standards in Construction Work, from the Combined Perspective of Supervisors. *Journal of Research Safety*.

- Wu, X., Yin, W., Wu, C., & Li, Y. (2017). Development and validation of a safety attitude scale for coal miners in China. *Sustainability (Switzerland)*, 9(12).
- Zhou, C., & Ding, L. (2017). Safety barrier warning system for underground construction sites using Internet-of-Things technologies. *Automation in Construction*. <https://www.sciencedirect.com/science/article/pii/S0926580517306702>
- Zhou, Z., Goh, Y., & Li, Q. (2015). Overview and analysis of safety management studies in the construction industry. *Safety Science*, 72, 337–350.



# TOWARDS A RESEARCH AGENDA FOR SMART CONTRACT ADOPTION IN LESS TECHNOLOGICALLY ENABLED CONSTRUCTION ENVIRONMENTS: A SYSTEMATIC LITERATURE REVIEW

Ekweani Chioma Precious<sup>1</sup>, Kolo Baba Adama<sup>2</sup>, Adogbo Kulomri Jaule<sup>3</sup> and Mohammed Abdullahi<sup>4</sup>

<sup>1</sup>*Department of Quantity Surveying, Baze University Abuja, Nigeria*

<sup>2,3,4</sup>*Department of Quantity Surveying, Ahmadu Bello University Zaria, Nigeria*

Smart contract (SC), a tool created for technologically enabled environments (TEEs) is poised to tackle the obsolescence within and inefficiencies of the traditional environments in construction. Generic considerations of SC are predicated on ideal TEEs, in spite of the slow pace of technology adoption in the construction industry. This is indicative of the fact that, quite a lot of less TEEs(LTEEs) still do exist in construction. But how should SC in construction be implemented within the LTEEs remains largely unknown, thereby creating the potentials for a research agenda within the LTEEs. This paper conceptualizes the state of the art of SC research in construction. A systematic literature review was undertaken to explore the ontology of SC in construction and applying the theory of technology adoption, the paper further characterized the ontological considerations into two domains i.e. TEE and LTEE. The outcome of this investigation revealed that under the LTEE perspective: existing research is challenged at addressing SC related issues; third parties are indispensable; and that the block-chain technology is most suitable for implementing SC. The findings provided information on how SC can be implemented in less technologically enabled environment. To conclude, the paper suggests that SC in construction research should be approached from a hybrid perspective whereby third parties (e.g. consultants) would still have prominent roles in contractual transactions as opposed to the fundamental principles of SC e.g. autonomous processes, and elimination of third party participation.

Keywords: construction, smart contract, technologically-enabled environment

## INTRODUCTION

SC has revolutionized the norm of traditional contracts in the construction industry. Studies show transactional transparency, independent processes and security of

---

<sup>1</sup> ekweanichioma@gmail.com Tel: 2348060188330

<sup>2</sup> babaadamakolo@gmail.com

<sup>3</sup> kjadogbo@yahoo.com

<sup>4</sup> bnabdallah02@gmail.com



payments in SCs which addresses major problems with progress payment in construction projects (Hamledari & Fischer, 2020; Ahmadisheykhsarmast & Sonmez, 2020; Li & Kassem, 2019; Alharby & Moorsel, 2017; Bartoletti & Pompianu 2017). SCs are contracts that are written in computer codes and operate on a block chain (BC). SC automatically verifies, executes and enforces a contract based on the terms written in the code (Wang, Yuan, Ouyang, Ni, Han & Yue-Wang, 2019; Cardeira, 2015; Natanoshi 2009). SC is an efficient and reliable means of payment used for automated execution of contract conditions needed to redeem the inefficient traditional payment system in the construction industry. In SCs, payment is made at an instantaneous effect which is largely unobtainable via the traditional contracts (Mason, 2017). The main attribute of SC according to Ahmadisheykhsarmast & Sonmez, (2020) is the provision of security of payment for construction works without incurring administrative costs or requiring intermediaries such as Architects and Quantity Surveyors (QS) in a traditionally procured construction contract. SC in an idea TEE uses big data sensors such as drones and reality capture cameras to monitor work progress and effect payment upon completion of tasks.

Despite the move towards technology advancement in the Construction industry, a lot of LTEEs still exist causing poor adoption of SC technology in the industry. Specific problems that researchers have solved in SC can largely be categorized into two –method and technology. 'Method-related' problems reveals non established systems for implementing SCs while the 'technology' problems indicated costs, crypto currency fluctuations, data capture/preparation time and accuracy of input data generated by reality capture technologies (Ahmadisheykhsarmast & Sonmez, 2020; Hamledari & Fischer, 2020).

Existing research on the use of SC technology to expedite payment in real time construction projects were done with reality capture technologies at the construction sites to confirm work done before automating on-chain payment. In LTEEs, SC technology might be impracticable hence an introduction of a human component is inevitable.

The traditional payment system requires inputs from both the Architect and Quantity Surveyor (QS) during the certification process which are usually complex in nature. These third party consultants are fundamental to progress payment and their quality assurance functions cannot be performed by technologies in use in the LTEEs. Hence, SC methodology would have to be modified to accommodate third party interaction.

There are currently no attempts in literature made to implement SC based on the contractual provisions governing construction contracts. Hence, this research hybridizes SC using block chain (BC) technology and the traditional payment system to cater for the peculiarities of construction projects by introducing a synergy between project consultants and SC technologies such that the consultants can play prominent roles in contractual transactions as opposed to the fundamental principles of SC e.g. autonomous processes, and elimination of third party participation projects.

## LITERATURE REVIEW

This section is divided into five sections to provide detailed information on the general concepts and applications of SC as found in literature. The first section discusses SC applications, the second section explored SC technologies, third section considered SC limitations, fourth section discussed SC features in TEEs and LTEEs and the fifth section looked at various interactions of SC in TEEs and LTEEs.

### SC applications

Researchers have dwelt on one major aspect of SC namely: progress payment of construction works (Ahmadisheykhsarmast & Sonmez, 2020; Hamledari & Fischer, 2020; Li & Kassem, 2019; Mason, 2019; Alharby & Moorsel, 2017, Cardeira, 2015). Over the years, the construction industry has experienced unsteady flow of payment for construction projects in real time. Payment has been a lingering problem in the construction industry and one of the top causes of disputes on site (Ahmadisheykhsarmast & Sonmez, 2020). Researchers have covered payment in three areas namely: Factors, Effects and Measures (Ahmadisheykhsarmast & Sonmez, 2020; Thanuja & Olabode, 2020; Li, Greenwood & Kassem, 2019; Peters, Subar, & Martin, 2019; Mohammad, Suman, Harum & Hasim, 2018; Hansen, Rostiyanti & Purnomo, 2017; Niazi & Painting, 2017; Ramachandra & Rotimi, 2015). The factors identified have been summarized into: Contractual issues, and financial issues (Peters et al., 2019; Hansen et al., 2017; Niazi & Painting, 2017; Ramachandra & Rotimi, 2015). The effects of late payment practices have led to negative cash flow for main contractors and delayed payment of subcontractors where as poor payment systems have caused destruction of trust between contracting parties and abandonment of contracts (Ahmadisheykhsarmast & Sonmez, 2020; Thanuja & Olabode, 2020; Peters, Sabar & Martin 2019; Li, Grenwood & Kaseem 2019; Mohammad, Suman, Harum & Hasim 2018; Niazi & Painting 2017; Ramachandra & Rotimi, 2015). Quite a number of proposed measures to payment exist in literature, the common one been: creating a feasible form of financial security at the outset of a project which formed the basis of the argument in this paper (Ahmadisheykhsarmast & Sonmez, 2020; Hamledari & Fischer 2020; Moumita et al., 2020).

It has become evident that the traditional system cannot address the inefficiencies of payment problems for construction works (Ahmadisheykhsarmast & Sonmez, 2020; Hamledari & Fischer, 2020). Hence, there is a paradigm shift to an automated system which supports the new normal ushered by the pandemic. SC with features such as transparency, security of payment, autonomous transaction and guaranteed execution is the new deal (Ahmadisheykhsarmast & Sonmez, 2020; Hamledari & Fischer, 2020; Brydon & Wang, 2018; Cardeira, 2015).

### SC Technologies

#### *Blockchain (BC) technology*

BC is a way of storing records of value and transactions; a database (Gates, 2017). Most transactions between people require an intermediary (e.g banks) to provide trust, security and to facilitate transactions. BC technology removes the need for an intermediary, allowing people to transact directly and promote trust and assurance with each other (Gates, 2017; Mason, 2017). In order for a transaction to be processed, it is grouped with other transactions and added to a new block on

top of the previous block in the chain. Each block refers to the previous block number, linking them together in a chain. The chain of blocks in the BC links all the way to the first block on the chain thereby ensuring security. SC with BC technology transfers ownership of securities (lien rights) into the BC. A party (the contractor) is expected to perform some tasks on a certain date, once the SC verifies the completion of the task, it enforces the contract automatically by paying the contractor. The set out conditions are spelt out and imputed into the chain (Ahmadisheykhsarmast & Sonmez, 2020; Hamledari & Fischer, 2020; Gates, 2017; Mason, 2017).

### ***Decentralized Apps (DAPPS)***

These are apps that are open source, not controlled by one person or entity and runs across a distributed BC. DAPPS has no central server; instead users connect to each other through peer to peer connects (Gates, 2017). A web of interconnected SC can be used to create a fully autonomous organisation which is capable of carrying out functions similar to the traditional organisation.

### ***Reality Capture Technology (RCT)***

Robotic reality capture machines such as camera equipped unmanned aerial vehicles (drones) are machines used to document progress of tasks on site whose outputs are fed into the SC to value the percentage of works done and enforce payment accordingly (Hamledari & Fischer, 2020). The relevance of this technology to SC according to Hamledari & Fischer (2020) is argued to bridge the gap between the on and off chain realities, a limitation of using only the BC technology. Secondly, RCT captures the physical reality exactly as it is thereby introducing objectivity into the valuation of works and ensuring consistency across the chain as only reliable data are imputed.

### **SC Limitations**

Despite the potential advantages of SC, there are specific limitations of SC that researchers have identified which include: costs of acquiring RCTs, fluctuations of crypto currencies, data capture and preparation time, vulnerability (cyber attack) and misinterpretation of input data (if data are captured wrongly) (Ahmadisheykhsarmast & Sonmez, 2020; Hamledari & Fischer, 2020; Li & Kassem, 2019; Nanayakkara & Perera, 2018; Alharby & Moorsel, 2017; Kosba, Miller, Shi, Wen, Papamanthou & Hawk, 2016; Luu, Chu, Olickel, Saxena & Hobur, 2016; Natoli, & Gramoli, 2016; Zhang, Cecchetti, Croman, Juels & Shi, 2016). These limitations are arguably bearable compared to the magnanimous challenges of the traditional payment system which subjects valuation of works to the interpretation of the valuer. Additionally, the discrepancy of the wrongly captured data affects only the timing of a minor fraction of the payment but not the entire valuation (Hamledari & Fischer, 2020).

### ***Cost:***

Acquiring RCT in LTEEs is capital intensive. The average cost of a drone with minimal gadgets is about N1, 500,000 (in Nigeria) which is a little too much for an average client in both public and private sectors. With digital cameras and a good smart phone, project progress can be captured with reasonable accuracy which offers a cheaper alternative.

### ***Fluctuation of crypto currencies***

SC utilises special currencies known as crypto currency for payment common ones being bitcoin (BTC) and ethereum (ETH). The primary difference between BTC and ETH is that BTC is mainly used as a distributed ledger for financial transactions while ETH is designed to be used as a distributed computing platform for running applications (multiple facets). Employers might incur losses due to fluctuations in the exchange rates of crypto currencies. The current exchange rate of ETH/NGN is 731,839.08 while BTC/NGN is 22,498,522.85 (Morningstar, 2021). A large amount of buying demand from an employer for a mega project is likely to lead to a rapid appreciation of ETH making this a limitation for adoption in large scale projects (Ahmadisheykhsarmast & Sonmez, 2020).

### ***Data capture and preparation time***

According to (Hamledari & Fischer, 2020), data processing time using digital images takes about 14 minutes excluding the data capture time from site. From processing to payment might take some days. Despite the ease of this process compared to the traditional payment system, for projects where time is of essence, there may be a need for a quicker technology.

### ***Vulnerability of SC platform***

Researchers have analysed the vulnerability of SC and categorised them into security and privacy issues. Cyber attack is a common phenomenon with technological inventions. According to (Dika & Nowostawki, 2020), "Reentrancy" which relies on the interaction between two SC is viewed as the most common severe vulnerability of SCs. This permits one SC interacting with another SC to retrieve multiple information from the interacting SC which can be used to defraud that SC if there is an incomplete interaction between them. Transaction origin, timestamp dependence, external calls, unchecked send-bug, etc other vulnerabilities identified by (Dika & Nowostawki, 2020) that limits the adoption of SC.

### ***Misinterpretation of data***

The accuracy of data fed into the SC is important in achieving best payment practices. According to (Hamledari & Fischer, 2020), a 5% inaccuracy was detected in the input data arising from the misinterpretation of a painted wall as a plastered wall. The implication is that 5% of the misinterpreted element was paid either too early or later. Although, this inaccuracy exists, it still offers a better result than the traditional format where the inspector might be biased.

## **Features of SC in TEEs and LTEEs**

### ***Automated Process***

The ability to enforce a contract upon the completion of certain tasks without any human intervention makes SC desirable in the new normal for contracting. Researchers reveal that the instantaneous potential of SC can be largely seen in its ability to save cost and time of projects as well as improving project performance (Mason, 2019; Bartoletti & Pompianu, 2017; Mason, 2017). This also eliminates the inefficiencies of managing hard copy documents.

### ***Compatibility with other technologies***

- A. **Building Information Modelling (BIM):** There is recent improvement in the adoption of BIM in the CI. Although BIM provides a yardstick against which smart contracts can align, Mason (2017) opined that SC should run solo so as to generate thousands of “straightforward contracts executed by high performance”. The argument is that if SC relies closely on BIM to operate, then there are chances of centralization of operations due to the issues with BIM adoption complexities across its levels (level 3: a single shared project model) which opposes the fundamental principles of SC.
- B. **BC technology:** BC is a distribution of database among a continuously growing list of transactions in units of blocks linked together and secured from tampering and breakage. BC offers enhanced speed of transactions with the potential for the real-time instant transfer (Gates, 2017). Researchers revealed that BC has the potential to change almost every industry in the world due to its transparency of transactions, removal of intermediaries and decentralization of operations (Lauslahti, Mattila & Seppala, 2017). SC works best on BC technology because it operates automatically without a central authority. Once the conditions written into the SC are met, payment is made and released and if not met, payment is withheld. Hence, series of activities/ sub contracts in a project can be linked together in a SC but operates independently. The beauty of SC with BC technology is that a uniform view and record of transactions are maintained throughout the chain and irrespective of the amount of new instructions fed into the block, the system remains intact.

### ***Third party elimination***

One of the attributes of SC is the elimination of a central control/ command. The decentralized nature of SC permits individual activities to operate independently without the authorization of a central command. This promotes objectivity and transparency and eliminates bias. It also improves the speed and accuracy of works as each component is structured to monitor progress and dispense value automatically once a completion command is triggered.

### ***Real time progress and records***

With the RCT upon which SC operates with, real time progress and records of daily tasks are captured using drones and big data sensors positioned strategically at different points on the construction site. Information is managed and disseminated across the block and progress of works can be tracked with ease. According to Hamledari & Fischer, (2020), a robotic reality capture machine was used to capture physical site progress while the SC dispenses payment when tasks were accomplished. This was used to make payment to seven subcontractors without relying on a centralised control mechanism. The subcontractors did not have to apply for payments because payment was made automatically once the SC confirms data received. The major challenge the researchers encountered using this approach is the data capture and preparation time which delayed payments for a few days.

### Interactions between TEEs and LTEEs

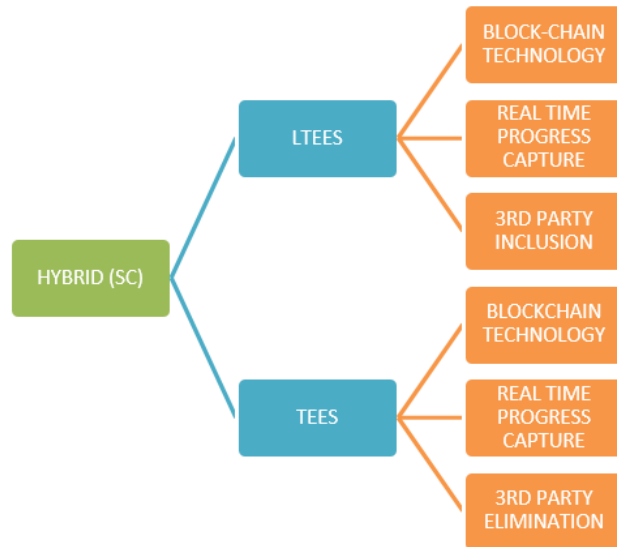

Figure 1: Interactions between SC environments

In LTEEs, technological advancement is at embryonic stage, hence full automation is unlikely and the inclusion of consultants for project supervision and endorsement of payment becomes inevitable. The study therefore, proposed a hybrid SC payment system to suit the complexities of the construction industry. In the proposed hybrid SC payment system, the contract is written as codes in the SC. Upon collection of data from site using digital cameras/ smart phones which is fed into the SC for verification of completed tasks. A consultant in the block-chain values and approves due amount to be paid to the contractor/supplier. SC verifies completed transaction and payment is made. Series of sub contracts can be written in blocks and added to the BC, such that many activities are going on concurrently without interference and progress of works can be viewed by everyone on the block. Hence, eliminating inaccurate progress report and delayed payment.

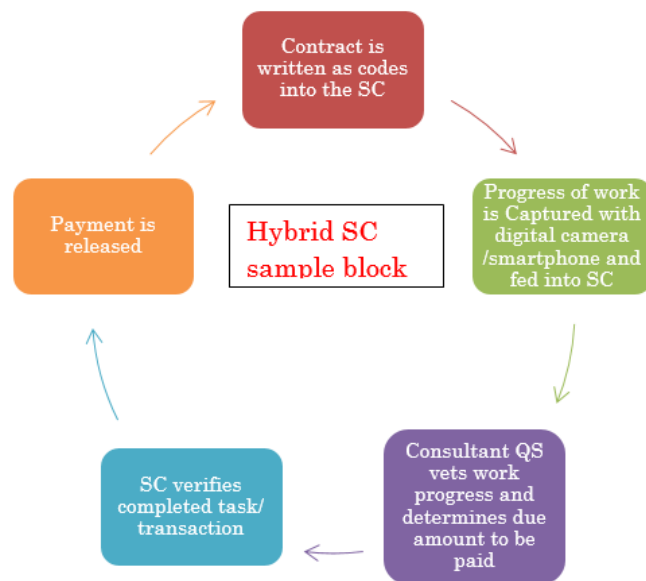

Figure 2: Hybrid smart contract block

## CONCLUSION

SC can be used to overcome the inefficiencies of the traditional payment system which has plagued the Construction Industry (CI) over the years. Advancement in technology in the Construction Industry has made the need for SC evident as it encourages minimal physical site interactions, transparency of transactions, and speedy delivery of projects. However, how SC should interact in LTEEs remained unknown. This study provided information to bridge the gap by establishing a hybrid SC payment system for adoption in LTEEs which will be tested in life projects as part of an ongoing PhD research work. The study also supports (Mason, 2019) on the semi-automation of SC in the CI for best practices. Major limitation of the study is the poor technical experience of construction consultants which can be overcome by awareness/training of consultants in technological skill acquisition/software development. The study is recommended for adoption in medium-sized public projects.

## REFERENCES

- Aggarwal, S., Chaudhary, R., Aujla, G. S., Kumar, N., Choo, K. K. R., & Zomaya, A. Y. (2019). Blockchain for Smart Communities: Applications, Challenges and Opportunities; *Journal of Network and Computer Applications*, vol. 144, pg. 13-48
- Ahmadisheykhsarmast, S., & Sonmez, R., (2020): A smart contract system for security of payment of construction contracts, *Automation in Construction*, Volume 120, 2020,103401, ISSN 0926-5805, <https://doi.org/10.1016/j.autcon.2020.103401>. (<http://www.sciencedirect.com/science/article/pii/S092658052030981X>)
- Alan, J., McNamara, Samad M. E. Sepasgozar. Intelligent contract adoption in the construction industry: Concept development, *Automation in Construction*, Volume 122, 2021,103452, ISSN 0926-5805, <https://doi.org/10.1016/j.autcon.2020.103452>. (<http://www.sciencedirect.com/science/article/pii/S0926580520310323>)
- Alexander, S. (2017). Contract Law 2.0: 'Smart 'Contracts as the Beginning of the End of Classic Law; *Journal of Information and Communication Technology Law*; ISSN: 1360-0834
- Alharby, M., & Moorsel, A. V. (2017). Blockchain-based smart contracts: A systematic mapping study
- Badi, S., Ochieng, E., Nasaj, M., & Papadaki, M. (2020). Technological, organisational and environmental determinants of smart contracts adoption: UK construction sector viewpoint. *Construction Management and Economics*, 1-19.
- Bartoletti, M., & Pompianu, L. (2017). An empirical analysis of smart contracts: platforms, applications and design patterns.
- Brydon Wang, A., Wang, B., & Brydon Wang, A. (2018). Addressing financial fragility in the construction industry through the blockchain and smart construction contracts. *Australian Construction Law Bulletin*, 30(1&2), 116-123. Retrieved from <https://eprints.qut.edu.au/131442/>
- Cardeira, H. (2015). Smart Contracts and Possible Application to the Construction Industry; Conference paper at Bucharest Romania, March 19-21, 2015

- Chaveesuk, S., Khalid, B., &Chaiyasoonthorn, W. (2020). Understanding Stakeholders Needs for Using Blockchain Based Smart Contracts in Construction Industry of Thailand: Extended TAM Framework. 2020 13th International Conference on Human System Interaction (HSI), 137-141.
- Christidis, K., & Devetsikiotis, M., (2016). Blockchain and smart contracts for the internet of things. IEEE journal, vol.2
- Dika, A., & Nowostawski, M., (2019): Security Vulnerabilities in Ethereum Smart Contracts. Conference paper. <https://www.researchgate.net/publication/333590995>, DOI: 10.1109/Cybermatics\_2018.2018.00182
- Gabert & Gronlund, (2018). Blockchain and smart contracts in the Swedish Construction industry. MSc Thesis at Institution for Real Estate and Construction Managemnt, Stockholm
- Griggs, K., Ossipova, O., Kohlios, C., Baccarrini, A., Howson, E., & Hayajneh, T., (2018). Healthcare blockchain systems using smart contracts for secure automated remote patient monitoring. Journal of medical systems, vol. 42:130, <https://doi.org/10.1007/s10916-018-0983>
- Hamledari, H., & Fischer, M. (2021). Role of Blockchain-Enabled Smart Contracts in Automating Construction Progress Payments. Journal of Legal Affairs and Dispute Resolution in Engineering and Construction, 13, 04520038.
- Keiron, H., (2017). Smart contracts-dumb idea; IEEE computer society 1089-7801/17
- Li, J., & Kassem, M. (2019). A proposed approach integrating DLT, BIM, IoT, and Smart contracts: Demonstration using simulated Installation task; international conference paper on smart infrastructure and construction (ICSIC): Driving data informed decision making. ISSN 978-0-7277-6466-9; <https://doi.org/10.1680/icsic.64669.275>
- Mason, J. (2017). Intelligent contracts and the construction industry; scholarly paper of ASCE. Doi:10.1061/(ASCE)LA.1943-4170.0000233
- Mason J., & Escott H. (2018). Smart Contracts in Construction: Views and Perceptions of Stakeholders.
- Mason, J. (2019). The BIM Fork - are smart contracts in construction more likely to prosper with or without BIM? Journal of Legal Affairs and Dispute Resolution in Engineering and Construction, 11, 02519002.
- Morningstar (2021): Currency and coinbase for cryptocurrency. <https://www.ngnrates.com/cryptocurrency/bitcoin-to-naira>.
- Moumita, D., Han, L., & Cheng, J. C. P. (2020). Securing interim payments in construction projects through a blockchain-based framework, Automation in Construction, Volume 118, 2020, 103284, ISSN 0926-5805, <https://doi.org/10.1016/j.autcon.2020.103284>. (<http://www.sciencedirect.com/science/article/pii/S0926580519312944>)
- Samudaya, N., Perera, S., & Sepani, S. (2019). Stakeholders 'Perspective on Blockchain and Smart contract solutions for construction supply chains. <https://www.researchgate.net/publication.334132411>
- Shojaei, A., Flood, I., Moud, H., Hatami, M., & Zhang, X. (2019). An Implementation of Smart Contracts by Integrating BIM and Blockchain. Conference proceeding DOI:10.1007/978-3-030-32523-7\_36Corpus ID: 208112868



- Tharaka, H., Mika, Y., & Madhusanka, L., (2020): Survey on Blockchain Based Smart Contracts: Applications, Opportunities and Challenges, *Journal of Network and Computer Applications*, 2020, 102857, ISSN 1084-8045, <https://doi.org/10.1016/j.jnca.2020.102857>.  
(<http://www.sciencedirect.com/science/article/pii/S1084804520303234>)
- Woodhead, R., Stephenson P., & Morrey, D. (2018). Digital Constructions from point solutions to IoT Ecosystem. *Automation in Construction Journal* vol. 93 pg. 35-46
- Ye, X., & König, M. (2020). Framework for Automated Billing in the Construction Industry Using BIM and Smart Contracts. *Conference proceeding*. DOI:10.1007/978-3-030-51295-8\_57 Corpus ID: 225019274



# URBAN MORPHOLOGY AND CRIME PATTERNS IN URBAN AREAS: A REVIEW OF THE LITERATURE

Idris Isah Ilyasu<sup>1</sup>, Aldrin Abdullah<sup>2</sup> and Massoomeh Hedayati Marzbali<sup>3</sup>

<sup>1</sup>*Landscape Architecture Programme, School of Housing, Building and Planning, Universiti Sains Malaysia, Penang, Malaysia*

<sup>2,3</sup>*School of Housing, Building and Planning, Universiti Sains Malaysia, Penang, Malaysia*

The emerging challenges of urban planning and design professionals across the globe is on how to mainstream crime prevention and control in the planning and management of cities, and that rose the interest of Environmental designers in conducting research on urban morphology and crime. Researches on urban morphology provide sufficient explorations and understandings of crime areas and fear of crime in cities. Despite the effort so far, the existing literature on morphology of crime areas and pattern of crime presents different perspectives to the study of crime and spaces, reflecting the varied field of urban morphological research. There is a need to understand these perspectives in view of their directions and inherent limitations for effective understanding of crime pattern and urban morphogenesis in cities. The focus of the paper is on the understanding of different perspectives in the study of crime pattern and urban morphology in setting up an effective mechanism for crime prevention and control. Eighteen (18) paper articles and six (6) thesis published between 2010 - 2021 where selected based on the Environmental criminological research perspectives from the field of Geography, Urban Planning, Urban Design, Landscape Architecture and Architecture; and systematically reviewed based on their characteristics and then classified according their relevance to environmental criminology for analysis and drawing of inferences. The findings indicated that, there is inadequate empirical research on the influence of urban morphology on crime pattern in cities. Therefore, the paper recommends for further researches to focus on exploring the various elements of urban morphology and how they help in understanding the spatial distribution of crime in areas and the explanations they could provide for effective crime prevention and control in cities.

Keywords: built environment, crime pattern, environmental criminology, urban morphology

## INTRODUCTION

The greatest challenges facing the world in the 21st century are poverty, inequality, insecurity and climate change (Beall & Fox, 2009; UN-habitat, 2016 & 2019a). With more than half of the world's population living in urban areas, the reality of the

---

<sup>1</sup> urbanist2005@gmail.com

<sup>2</sup> aldrin@usm.my

<sup>3</sup> hedayati@usm.my

21st century is that these issues will impact strongly on cities and as Yunusa (2011) and UN-habitat (2020), indicated that, the battle against these mutually reinforcing situations shall be won or lost in cities.

Urban crime threatens the quality of life, human rights, social and economic instability and sustainable development in cities around the world (Baker, 1998; UN-habitat, 2005; 2019b & Umar, et al., 2015a). This is especially true in developing countries that have high poverty rates and many informal settlements. The poor are the worst affected by urban crime and violence, regardless of their geographical location (UN Habitat, 2007). Other studies further attested to the fact that usually, areas of the city that are most blighted by violence also happen to be the poorest (Alemika & Chukuma (2012); Assiago, 2017; Bernasco & Block, 2009; Winton, 2004; Umar, et al., 2015b).

The 2011 World Bank's position is that, if decisive action is not taken, the scale of urban violence can ellipse that of open warfare (World Bank, 2011, p.24). For millions of people in cities of the developing world, violence or the fear of violence is a daily reality (Ojo & Ojewale, 2019; UN Habitat, 2019a). Rising urban crime across Africa contributes to pervasive fears that impede commerce, fray social capital and undermine normal urban activity (Assiago, 2017). The 2020 Global Report on Human settlements estimated that over 60% of all urban residents have been victims of crime with 70% of them in Asia and Africa (Unhabitat, 2020, p. 16).

Different conceptions of crime in design practice, sociology, environmental psychology, and criminology indicate an extensive articulation of crime in relation to the built environment and urban form in the city (Cozens et al., 2019 & Carr, 2020; Wuschke & Bryan, 2018). Five decades of different studies on urban crime, crime prevention through environmental design, and fear of crime indicate an implicit and gradual movement from deterministic to possibilistic propositions in exploring the relationships between urban crime and environmental design both in theory and practice (Curman, et.al., 2015 & Umar, et al., 2018). In this way, various dimensions of crime prevention in both theory and practice can be categorized into morphological, social, functional, and perceptual dimensions. While the social and perceptual dimensions of crime phenomenon have been widely addressed in criminology, environmental psychology, and sociology disciplines in terms of fear of crime, sense of community, people participation, demographic profiling, socio-economic attributes, risk, and victimization. The morphological and functional dimensions of urban crime have been relatively less explored comprehensively as a complex combination of urban forms and functions in relation to social and perceptual outcomes (Eck & Weisburd, 1995; Wuschke, 2016, & 2018). Moreover, considering the complexity of the city as a combinational network of multi-scalar activities and emergence, the issue of urban crime needs to be explored in relation to various scales and dimensions of the city and urban environments.

Considering the large body of knowledge and research on the issue of crime in relation to the built environment in terms of spatial structure, demographic status, urban morphology, sociocultural and economic condition, it is probable to conceive an evolutionary process in which different approaches and trends advocate for a comprehensive articulation of the complex relation between crime and the city (Cozens, 2007; Perkins, et.al, 2009; Salau & Lawanson, 2010; Silva & Li,

2020). Despite the fact that crime is one of the critical problems of cities worldwide, most of the previous studies have been conducted in sociology, criminology, and psychology in order to either explore the sociocultural and economic predictors of crime, whether in sociocultural context or individuals, or evaluate the proposed theories or propositions (Cozens, 2011). However, although the studies have gradually extended the crime discourse over the hedge of narrow-minded determinism that was implicitly embedded with the early trends of environmental research on the issue of crime, they have relatively ignored or reduced the "complexity of the city problems" (Jacobs, 1961; Jones & Fanek, 1997; Lamy & Madanipour, 2006) into crime statistics while abstracting crime from its urban context. However, whilst planners and designers need to adopt theories and propositions in relation to spatiality and sociality domains in order to forecast the social outcomes of their spatial amendments in the built environment, the efficiency of these propositions remains ambiguous while societies are paying the price and the challenge is overwhelmingly critical when "design-level" theories are needed for interventions (Hillier & Sahbaz, 2008; Ojo & Ojewale, 2019; Umar, et al., 2020). Thus, conducting a theoretical review the paper posed a question on what should guide the focus of future research in crime and environment through the exploration of the morphology of urban spaces, for understanding the pattern of crime and criminal activities in cities as basis for drawing up a Planning and Design framework for developing crime resilient cities.

## **METHODS AND MATERIALS**

### **Literature search**

This paper focused on the role of urban morphology in understanding crime pattern. It also attempted to review the influence of such findings in shaping crime prevention frameworks in cities. The research objectives were addressed by conducting a comprehensive systematic review of most recent literature that examines the influence of built environmental elements in understanding crime pattern in urban areas. A systematic and extensive search was conducted in several electronic databases, which include articles published from 2010 to 2021 as suggested in the PRISMA statement (Moher, et.al., 2009). The literature search was conducted between August, 2019 to January, 2021; using the major databases, including Web of Science, Scopus, ScienceDirect and Sci-hub. The search keywords used include: 'environmental criminology', 'urban morphology', 'Design out crime', 'crime pattern', 'crime and urban form' and 'crime prevention through environmental design'.

### **Literature review criteria**

In the course of selecting publications to include in the review and subsequent analysis, no geographical limit was set against inclusion or exclusion of materials, but rather adopted a worldwide domain. The selection process was conducted in two stages. The titles and abstracts were assessed, and then the whole text of selected articles was reviewed. A definition of inclusion criteria was conducted prior to the extensive search. The inclusion criteria for articles used include:

- published between 2010-2021,
- published in peer-reviewed journals and unpublished Thesis written in English,
- highly cited,

- relevancy to the objectives of the study,
- outcomes related to Sociological, Psychological and Economic aspects of crime were excluded,
- interconnection analysis and ability to answer research questions.

Our search identified 106,097 records. After title screening, approximately 312 articles were found appropriate. Consequently, further screening was carried out based on the content of the abstract, 55 records were selected based on their appropriateness to the study focus. Finally, 20 records were selected for detailed content analysis. Unpublished thesis was also used, six (6) Thesis were purposively selected and analysed; the findings have been presented in the discussion.

## **LITERATURE REVIEW: CONCEPTS AND THEORIES EXPLAINING CRIME PATTERN IN URBAN AREAS**

### **Concept of urban morphology**

Before identifying urban morphology and urban form, it would be useful to look into the origin of the words. As stated in various dictionaries, morphology is constituted from the Latin words *morphe* (form) and *logos* (description); therefore, morphology is concisely the description of form. The Oxford English Dictionary defines morphology as the particular shape, form, or external structure of an organism, or landform. It is also described as the history of variation in form. Form is characterised as the general system of arrangement, whereas figure is defined by lines and angles. Ching (1996) defines form as a three-dimensional mass, which also concerns figure and shape; it is the external outline, internal structure, and the unity of the whole.

Urban morphology is defined as “the organized body of knowledge” and “integral part of urban geography”; it relates forms to their socio-economic context and historical development (Psarra, 2012 & Krieger, 2006; Whitehand, 1987). Urban morphology is about shapes, forms, spaces and places; it is also associated with the nature and scale of physical places and the connections between them. It can be both descriptive and classificatory. It also focuses on the question of “how and why settlements took the shape they did” which includes analytical element of morphogenesis (Kalimavour, 2016). It is the study of the city as a human habitat (Moudon, 1997). Despite multiple definitions, briefly, urban morphology means the structure or the study of urban form (Kropf, 2005; Larkham, 2005; Whitehand, 2005).

Urban morphology was firstly defined in the geography literature. Geography deals with the morphological processes of settlements; and the main pioneers of this discipline are (Conzen, 1960; Kropf, 2001; Larkham, 2005; & Whitehand, 1987). Secondly, Architecture tackles the typological processes of the subject and here we can mention (Lefebvre, 1994; Malfroy, 1986; Moudon, 1998; Psarra, 1997) as the forerunners. Thirdly, philosophy, which tackles the philosophical processes within urban morphology, differs from the other disciplines in that it questions more the social issue of space. The key proponents of this approach are Harvey, Foucault, Lefebvre and Harvey (Madanipour, 1996). Fourth, urban design deals with the public space network, space and place issues, and (Krieger, 2006; Lynch, 1960 & 1981; Jacob, 1961) and many others can be mentioned here. Finally, by the late

twentieth century, in terms of science, Geographical Information Systems GIS, Space Syntax by Hillier and his colleagues (1970s), and other mathematical models by (Alexander, 1977; & Salingaros, 2000) can be cited as recent quantitative approaches to the analysis of urban morphology (Cozens, 2019; Sima & Zhang, 2009).

In addition, urban form is described as the basic element that gives character to cities. Morris (1994) mentions that it is how we conceptualise the complexity of physical form. Urban form is composed of buildings, streets, squares, roads, and all the elements that comprise the city. It is the outcome of a process that is formed by specific determining forces (Larkham, 2005). Alkim, (2006) classifies these forces under two groups; firstly, geographical factors such as climate, topography, and local construction materials, and secondly, man-made determinants such as socio-political and economic powers, culture, and religion.

Therefore, urban morphology is related to the history of the city, spatial relations, social relations, economic relations, culture, traditions, various factors shaping that form, and its rural/urban landscape. It is about the people, institutions, regulations, and management. Therefore, it is an important phenomenon and an analytic tool, which helps cities to understand their development processes, and the characteristics of each element in the city.

### **Crime and urban form**

Exploration of crime and place is a rapidly evolving area of research in the 21st century. Some of the early works in the 1970s examined topological structure of neighborhoods, identifying a way to measure the permeability of edges of the neighborhood, allowing crime committed by non-residents to drift away from the usual location along major streets into roads toward the centers of neighborhoods (Brantingham & Brantingham, 1993c). For decades, researches focus on understanding of crime and the urban environment, particularly how people live in and interact with the landscape (buildings, people, roads, and activities) that surrounds them. It advances understanding of crime within the urban landscape (Brantingham & Brantingham, 1995). Crime changes with urban development patterns. Opportunities for criminal activity emerge, disappear, or move as geography changes across the urban landscape (Weisburd et al., 2012). Patterns emerge, dissipate, or persist; but crimes are far more predictable by place of occurrence than by a particular offender (Umar, 2020).

Jacob's book *The Death and Life of Great American Cities* (1961) was the first contemporary piece to show how an active street life could considerably reduce opportunities for crime. This was followed by Jeffery's book *Crime Prevention through Environmental Design* (1971 & 1977). Jeffery considered a broad array of environmental factors that influence offenders, including the physical environment (urban form and design), the legal environment (reinforcing rules and regulations), the economic environment and social structures and social organization. The work stimulated researchers such as the Brantingham, Felson and Clarke, as well as professionals such as planners, geographers, sociologists, psychologists and architects to study crime in relation to environmental factors (Cozens et al., 2019).

Criminal events are inseparable from the environments in which they occur. The origins, pathways, and destinations of individuals are shaped by their physical

surroundings. In urban environments, in particular, the built physical form of the city encourages (and often restricts) movement along specific, planned pathways, which connect the origin and destination points such as; residences, workplaces, schools, shopping and entertainment areas, to name a few (Boivin & D'Elia, 2017; Boivin & Felson, 2017; Frank et al. 2013). As urban structure shapes patterns of movement, so too does it shape patterns of criminal activity (Brantingham & Brantingham, 1995; Brantingham et.al. 2015; Bowers, 2010; Boivin & D'Elia, 2017; Johnson & Wuschke, 2007; Wuschke 2016; Wuschke & Bryan, 2018; Silva & li, 2020). Changes to the built urban environments, such as urban development, growth, decline or gentrification, are designed to shift the movement within and use of urban spaces; as such, these processes may have considerable impacts on the distribution of criminal activity.

### **Theories explaining crime pattern in urban areas**

Studies in environmental criminology have also indicated that there is a strong relationship between the patterns of crime in a city and the urban form. In 1978, Paul and Patricia Brantingham studied how crime locations scatter themselves into specific patterns in relation to the variables that govern growth of cities. Older cities with concentric zonal forms have crime-locations concentrated towards the dense core of the city. The cities with mosaic patterns that are relatively newer seemed to have a scattered pattern of crime spots. The patterns of roads in a city also have a relation with the patterns of crime because the roads determine the accessibility to potential crime spots in a city. Cities built on gridiron patterns are known to have higher crime rates when compared to cities with naturally developed street layouts, (Brantingham & Brantingham, 2000, 2008; Silva & Li, 2020).

Environmental criminologist attempted to predict crime based on elements such as target distribution, land use patterns, transportation pathways, and offender residence distributions (Suryavanshi, 2001; Rengert, 2004; Wuschke & Bryan, 2019). They have proposed models of decision making that lead potential offenders to specific targets and specific locations (Brantingham & Brantingham et al. 2009; Curman et al. 2015; Brantingham & Brantingham, 2015; Hashim et al., 2019). The criminality of place is most often connected to the level of activity, ease of access, the presence of juveniles, and the presence of easy targets or victims. The sense of place is temporal by nature. People may feel fear in a dark parking lot at night, but completely safe in the same parking lot during the daytime. In essence, criminal places as well as criminal activities have a temporal dimension in accordance with environmental criminology (Meena, 2016 & Perry, 2017). Crime and urban form researches have also explored potential offender decision making by arguing that crime is associated with offender awareness of space that led to decisions about target attractiveness. Crimes occur where and when the immediate environment makes the offender feel that a crime can be committed with reasonable safety and ease. Conversely, victim decision making can affect crime patterns. Victims' choices about where to work, shop, or play affect their chances of coming in contact with offenders (Kim, 2018 & Cozen, 2019). Several theories have emerged over time to provide comprehensive understanding on the inter play between crime and the environment, table 2.0 has provided summery of these theories and their fundamental assumptions and inherent limitations as observed by researchers.

**Table 2.0: Theories explaining crime pattern in urban areas**

Theories	Author (s)	Assumptions	Emerging criticisms
Opportunity Theory	Clarke, 1983; Wortly, 2008, 2010	The theory proposes that urban crime analysts should search for concentrations of offence targets and reduce the chances of re-offending. The basic assumptions here is that more opportunities lead to more crime, easier ones attract more offenders and such existence of easy opportunities makes possible for a lifestyle of crime within urban settings.	The theory attracts its own criticisms. It was considered counterproductive as it does not alter the disposition of criminals to continue offending and was also criticized on the grounds that it led to crime displacement across areas.
Social Disorganisation	(Park & burgess, 1928; Park et. al., 1969; Shaw & Mckay, 1942)	The effects of location and location specific characteristics of fragile communities such as poverty, ethnic heterogeneity, and weakened social stability influences the perpetuation of crime.	The theory has been criticized by environmental criminologist for been purely offender focused approach to investigating the occurrence of crime while ignoring the influence of built environment on crime - criminal events.
Rational Choice Theory	(Cornish & Clarke, 1986; 2008)	The theory assumes that criminals think exactly the same way as non-criminals. That crime perpetrators within urban settings intentionally choose to commit offence largely because they feel it would be more rewarding for them than non-criminal behaviour. The theory also, places greater emphasis on the influence of purposive behaviour in the risk-reward calculation of offenders.	The theory placed emphasis on impulsive behaviours of offenders in committing crime. Several critics argue that impulsive emotions can have significant effects on the predisposition to commit crime. Other critic of the theory shows that other extenuating factors may influence offenders and that they may not always act rationally.
Routine Activity Theory	(Cohen & Felson, 1979; Eck, 1995; Felson, 1995; Felson & Clark, 1998; Felson, 2008)	The theory suggests that the organization of repetitive activities in urban settings creates opportunities for crime. The assumption here is that crime occurs when: there is an offender who is motivated enough to commit a crime; there is a target against which the motivated offender can strike; a capable guardian for the potential victim is absent at the place and time when the offender strikes; there is a presence of a place manager and a handler capable to exert some control over the offender.	The theory over time has attracted a number of criticisms. This includes the assumptions that: the offender has to be motivated; it contradicts the assumptions of other criminological theories such as crime pattern theory which focus on the spreading of crime.
Crime Pattern Theory	(Branting ham & Brantingham, 1993, 1995, 2008; Eck & Weisburd, 1994)	The underlying premise for the crime pattern theory is that crimes do not happen randomly or uniformly in time, urban space, across social groups and during daily or lifetime routines. Similarly, there are those offenders who repeatedly commit crimes within urban settings and there are targets (persons and places) that repeatedly fall victim to such crimes.	Although the theory has been popularized within the domain of environmental criminology, it still faces some criticisms. The underlying assumptions that are used to create the routine activities triangle comprising Nodes, Paths, and Edges focus largely on the behaviours of criminals and victims which can change from time to time. Consequently, the theory struggles to address the root causes of crime.
Crime Prevention Through Environmental Design (CPTED)	(Jeffery, 1971; Newman, 1972; Moffat, 1983; Cozens & Love, 2015)	The central assumptions made by CPTED is that the built environment represents an important underlying determinant of crime. The idea here is that an efficient and effective utilization of the physical environment helps to reduce crime. "There are no criminals...only environmental circumstances that result in criminal behaviour. Given the proper environmental structure, anyone will be a criminal or a non-criminal" (Jeffery, 1977, p.177).	CPTED has attracted a range of criticisms from criminologists. CPTED proposes environmental design methods such as target hardening and restrictions and control of access; some of these methods actually create urban fortresses which further entrench urban segregation. Another criticism of CPTED is that it also led to the displacement of crime.



## FINDINGS AND DISCUSSIONS

### Perspectives of researches on urban morphology and crime pattern

It is clear that research on Environmental Criminology has largely focused on the relationship between patterns of crime and urban form and has gained considerable attention in the last four to five decades (Cozens, 2007; Meena, 2016 and Carr, 2020; Song et.al. 2016). Advances are evident from theoretical perspectives, pointing at best approach to view and better understanding of crime events, management, prevention and control, and in terms of methodologies in conducting empirical research to test the validity of such theories. This trend has addressed a lot of pressing questions with some fascinating explanations as to why, where, when and how crimes occur. As new findings continue to emerge prompting new sets of questions, much research is still needed to provide more answers (Azande, 2015; Danis, 2012; Groff & Lockwood, 2014; Mihinjac & Saville, 2019; Umar, 2018; Zubairu, 2016).

**Table 3.0: Perspectives of researches on urban morphology and crime pattern**

Perspectives of Researches	Author(s)	Discussions	Limitations of the studies
Geographical	(Ahmed, 2010; Ackerman & Murray, 2004; Adel, et al., 2016; Arthur, 1994; Appiahene-Gyamfi, 1999; Emamanuel et.al, 2015; Hillier & Shu, 2000; Isin, 2012; Rengert & Brain, 2009; Ratcliffe, 2012; Song, et al., 2013a. Umar, 2017, 2020)	Urban form and pattern of crime largely focus on exploring the spatial pattern of crime in spaces over period of time, with emphasis on macro scale of analysis for the understanding of the social and spatial environmental elements that could provide explanations of crime for effective crime prevention and control.	The studies are limited to the exploration of crime pattern over space and understanding of the influence of spatial forms at neighbourhood level of analysis, ignoring the role of social indices such as poverty level, education and land use mix in explaining crime events and pattern across areas of the city.
Urban Planning	(Cozens et al., 2020; Hillier, 2008; Heidarzadeh, 2014; Kim, et al., 2017; Kim & Hipp, 2019; Lopez & Nes, 2007; Ojo & Ojewale, 2019; Satiawan, et al., 2018; Salau & Lawanson, 2010; Summers & Johnson, 2017; Wuschke, 2016; Zubairu, 2017).	Urban form and pattern of crime researches largely dwell on the impact of planning decisions on urban transformation with respect to land use change dynamics, social and physical infrastructures and safety and insecurity in cities. The focus here is on how these decisions explain crime events and distribution over space and how possible it is to plan for crime prevention and control in cities.	The studies mostly focused on micro to macro spatial design conditions which are relevant to spatial design intervention, spatial designer and spatial design prevention policy making. These explanations are limited in terms of scale of analysis to district levels without consideration to the wider city network of crime flow.
Urban design	(Arabi et al., 2020; Armitage, 2004; Azande, 2015; Beavon et al., 1994; Bowers, 2013; Brantingham & Brantingham, 1995; Crowe, 2000; Curman et al., 2015; Dwidinita et al., 2018; Frank et al., 2013; Groff, (2014; Groff & McCord, 2012; Kinney et al., 2008; Jeffery, 1992; Lin, 2010; McCord & Ratcliffe, 2009; Newman, 1996)	Urban form and crime studies largely deals with the public space network, space and place issues with respect to crime prevention through urban design. The focus of urban design studies on morphology of space and pattern of crime is to reduce the opportunities for crime through alteration of situational factors or modification of physical settings at which a crime event is likely to occur, i.e., Crime prevention through Environmental Design.	These studies consider only the physical elements at the buildings and streets level (micro scale), without making reference to the social fabrics of the places of crime events. The studies are limited to the physical fabrics of the places in terms of Target hardening, Surveillance and image of the areas, ignoring the influence of macro form elements such as connectivity to other areas and Land use dynamics of the city.
Architectural	(Bafna, 2012; Lefebvre, 1994; Legeby, 2009; Marcus, 2007; Psarra, 2009; Carr, 2020; Marzbali, et al., 2015, 2016, 2017, 2018, 2019a & 2019b; Meena, 2016; Milinjac & Saville, 2019)	Urban morphology and pattern of crime studies focus on typological process of buildings and opportunities they present to crime events in terms of attraction, prevention or control. The research concern here is on how building design and construction as well as organised open spaces attracts crime or deter crime in areas and what inform a better design of buildings and Spaces for crime prevention and control.	Most of these studies evaluated the role of Crime prevention through environmental design (CPTED) models in understanding the crime pattern, fear of crime and victimization across areas. The studies largely looked into the CPTED suitability and applicability in crime prevention while under plying the model's adaptability to different urban forms.

It is important, however, to note that contributions to this field of research have been approached from different disciplinary perspectives, such as; Geography, Urban Planning, Urban Design and Architecture, to explore the interaction of crime with space through morphological analysis of places (Groff and Lockwood, 2014; Kamalipour et al., 2012; Kamalipour et al., 2014; McCord & Ratcliffe, 2007; Kinney et al., 2008; Perry, M.A., 2017; Wuschke, 2016). However, table 3.0. indicated that, even within these professional disciplines there are lots of variation in context in terms of research focus.

## **LIMITATIONS OF RESEARCHES ON URBAN MORPHOLOGY AND CRIME PATTERN**

Lynch, 1960 and Jacobs, 1961 has identified the critical role of urban planning in explaining urban crime, violence and juvenile as well as a profession that provides a viable opportunity and environment for prevention, management and control of deviance in urban areas (Moudon, 1997). Since then, the study of crime has become a research interest to several urban researchers, such as; (Adel et.al., 2016; Ahmed, 2010; Azande 2015; Cozens, 2008; Felson and Boivin, 2015; Kalimapour et.al., 2014; Kropf, 2001; Larkham, 2005; Umar, 2017; Whitehand, 1981). Most of these studies examined crime in the context of urban morphology and draw understanding on the explanation of crime events and pattern in urban areas. Though the studies vary in the context of morphological analysis and approaches adopted. According to the morphological theory, for effective explanation to be provided through morphological analysis on crime pattern, it is necessary to consider all the fundamental elements of form, resolution (scale) and time (history) (Conzens, 2001, 2005, 2008; Kumar & Borbor, 2018; Moudon, 1997; Wharton, 2005; Whitehand, 1981, 2005).

Moreover, most studies adopt different elements for consideration in the analysis from which explanations were drawn. For instance, using police recorded data (1980 – 1996), the PhD work of Appiahene–Gyamfi applied morphological approaches to examine the spatial ecology of six crime types in Ghana (Appiahene–Gyamfi, 1999). Although much of the analyses presented in that work were descriptive, the findings suggested that crime is unevenly distributed across regions of Ghana. Considering the patterns of journey to crime in the city of Accra, the study also revealed that suspected burglars lived in slum neighbourhoods but travelled to planned neighbourhoods to commit burglary offences (Owusu et al., 2015). The study adopted crime ridges theory which seek to explain pattern of crime in spaces by exploring journey to crime areas; and is limited to only elements of form and resolution (scale) ignoring the role of time (historical transformation) of areas.

Suryavanshi (2001), studied urban morphology and opportunities for crime in the cities of Sarasota Florida and Boston. The study used elements of form (Land uses) and history of city transformation to draw understanding of the crime pattern in the areas of the cities, the morphogenic factors responsible for the spread of crime events. The study is limited to only land uses and how the transformation of land uses influences change in the form of areas and how the form informed the crime events in the hot spots studied.

In a Ph.D work by Armitage (2004) attempts were made looking into the performance of an existing crime prevention programme "Secured by Design (SBD)" in areas of Huddersfield UK. The research examined the history of crime and the programme, the current practices and the possible future challenges of the programme. The work is a morphological study of crime places in the areas of the city, and its focus were mainly on the micro scale analysis of the selected estates and as well as planning history for the understanding of the current situation of crime incidences within the areas studied. Less emphasis was given to the physical form of the study areas; therefore, the study was limited to the understanding of the crime in places rather than influence of flow of people and activities on the crime events in the city.

The analysis made by (Ahmed, 2010), examined the pattern of crime distribution in Osun State of Nigeria over a period of Fifteen years (1985-2000). The study was limited to the understanding of pattern and distribution of crime incidence in the areas of the state. Moreover, the morphological elements used in the study were scale (neighbourhoods and local governments) and history of crime locations or areas; ignoring the roles of elements of form in providing adequate explanation on the pattern and distribution of crime incidences across areas of the state.

Crime spatial analysis were carried out in Akure Town, Ondo state of Nigeria by (Emmanuel, et.al, 2015), to established the factors responsible for the spatial spread of crime activities in the town; focused mainly on the spatial analysis of the spread of the factors of crime activities in the area. The study used only element of scale in analyzing the morphology of the areas in explaining the spread of crime activities across space; hence ignoring the elements of form and time which could have provided an in depth understanding on the geographic spread of crime activities in the areas of the town and also inform better policy decisions on prevention and control measures to be taken.

The applicability of CPTED in city of Accra, Ghana was studied by (Owusu et al., 2015), the study found that rising crime rates in the city of Accra has led to the adoption of target hardening measures (e.g., use of burglary- proofed windows, high walls, security doors etc.). Responding to crime through these measures in the context of Ghana, however, has had limited impact on the rates of crime in communities and in the long term, has tendency to weaken social cohesion among communities. The study explored the applicability of Target hardening component of Crime prevention through Environmental Design with respect to understanding its impact on crime control in communities of Accra Ghana. The study considered only spatial scale and history of community transformation, while ignoring the role of form of spaces in explaining the crime pattern across communities in Accra Ghana.

The applicability of Territoriality principle of CPTED were looked at by (Azande, 2015) in Makurdi Town with the view of establishing its effectiveness in reducing the crime prevalence in the High, Medium and Low-income residential areas of Makurdi town, Benue state of Nigeria. The work dwell on the statistical tests to measure its applicability and effectiveness. The findings indicated that there is no variation of the effectiveness of the application of the principle among the three categories of selected residential areas. The study concluded with a call for further

studies to conduct an in-depth micro and macro analysis of residential areas so as to provide better explanation on how best to apply the CPTED approach for effective crime prevention and mitigation in Nigerian cities. Again, this research focuses mainly on form and scale ignoring the influence of the historical transformation of the area on crime prevalence.

In a PhD work by (Wuschke, 2016), the connections between urban space, development and pattern of crime in the selected areas of cities of Coquitlam and Port Coquitlam BC, Canada were examined. The study was able to establish that, built urban environment influences the spatial distribution of criminal activity. Common activity nodes are clustered in specific urban areas, drawing individuals from within and beyond municipal boundaries for legitimate, daily needs; and the importance of locally based, micro-scale analysis when exploring connections between crime and the urban environment. Despite these explorations, the study has not provided explanation on the transformation process of the form of the areas of the cities studied for drawing adequate understanding of the flow of crime activities beyond boundaries for driving effective planning policy for effective crime prevention and control.

The PhD. work of (Umar, 2017), specifically looked into utility of the Euro-American theories in explaining spatial pattern of crime in developing cities, using Kaduna metropolis, Nigeria as a case study. The work was purely based on statistical test, and hypotheses were tested regarding (a) whether the; law of crime concentration at places applies in the context of Nigeria and (b) the utility of the two main theoretical perspectives. The study adopted two environmental criminological perspectives; opportunity and social disorganization in explaining variations in the rates of urban crime supported by morphological analytical approaches of form and scale. The results of the findings were mixed, supporting premise of such theories in some cases but and different in others. The study made a novel exploration on spatial criminological research in developing countries, but yet could have done much better if it had extended the analysis to include the urban transformation process over time that brought about changes in the form and explanations drivable from that would have inform better planning policy for prevention and control of crime in the city.

The Ph.D. research by (Kim, 2018), further elaborated the relationship between urban environment and crime pattern in cities. Kim examined how the Land uses, street network connectivity, and physical boundaries in urban settings dictate the activity patterns of persons; and thus, influence spatial crime patterns. The research made remarkable contributions to the understanding of the roles of urban form and structure in explaining varied crime patterns in urban areas, yet less attention was paid by the study in distinguishing the specific characteristics of the physical environment that is of utmost important for the understanding of crime location and patterning in cities.

The study on the influence of Urbanization on Urban crime is the work by (Ojo & Ojewale, 2019). The research made an in-depth exploration on the relationship between urbanization and Crime in some selected Nigerian cities. The study offered theoretical and empirical explanations of the factors within the Urban environment in Nigerian cities that shape and are shaped by criminal activities. The

data used for the empirical analysis to arrive at the conclusions were drawn from Police crime records which were poorly recorded, were scanty and does not represent the true situation of crime events on ground across the sample areas used in the study. The main limitation of the study is under playing the importance of understanding the relationship between the Built environmental transformation as influenced by Urbanization processes and Urban crime pattern.

Several researches were carried out to further understand Urban crime occurrences in relation to built environmental characteristics (Urban Morphology) and its implications on the future of Urban design strategies in cities, one of which is the work by (Silva & Li, 2020). Silva and Li attempted to further explore the influence of the built environmental elements on urban crime occurrences and how the understandings of the factors will inform the future urban design strategies using African cities as case study. The research further developed a set of Urban Environmental Quality Indicators (UBEIs) for the cities under study based on the two data sets: Building footprints and Road networks at the neighbourhood level across the studied areas. The research concluded that, the physical form of the urban built environment is substantially associated with the crime rates. The limitation of the research is that the spatial mobility of crime across areas were not captured in the variables used in the analysis, and this limits the findings on understanding the flow of crime across neighbourhoods and the built environmental characteristics that drives the flow and the factors responsible for the spatial variation of crime rates across space.

Recently, (Carr, 2020), in a thesis argued that Crime Prevention Through Environmental Design (CPTED) results to the development of Hostile Urban Architecture that excludes the major segment of the community in an attempt to instill crime preventive mechanisms in place for the few. The study further argued to justify that much has not been achieved in terms of crime reduction in the areas where CPTED were implemented, but rather exclusion of the Urban majority from getting access to the shared Urban public spaces. The researched concluded that, the proponents of CPTED: Jacobs, Newman, Jeffery, Cozens and a host of others attempted to established a program to enhance public security and safety through the manipulation of the built environment, but instead researched has established that they only end up with a dangerous precedent for urban public space. The study was limited in focus to the impact CPTED implementation on the Urban public spaces rather than looking at it in the context of Urban built environment and its influence on manipulating the built environmental characteristics towards achieving an improved secured habitation for people.

In summary, a number of common themes emerged from within the focused body of these researches exploring crime within the context of built urban form. First, while consistencies exist across a number of urban areas, key environmental features can have different associations with crime patterns in different urban environments (Ahmed, 2010; Arabi et al., 2020; Bolton, et.al., 2017; Carr, 2020; Chiodi, 2015; Erdogan & Erkan, 2020; Frank et al., 2013; Hashim et al., 2019; Heidarzadeh, 2014; Hipp, et.al., 2018; Kim, 2018; Kim & Hipp, 2019; Nangia, et.al., 2019; Ojo & Ojewale, 2019; Perkins et al., 2009; Siti & Abdullahi, 2012; Silva & Li, 2020; Song et al., 2016; Taylor & Harrell, 1996; Umar, 2018, 2020; Wuscke & Bryan, 2018). However, while such findings have clear potential value to Planners, Urban

designers and policy makers alike, there is still inadequate understanding of the influence of urban morphology on crime pattern in our cities as established in the previous studies. There is absence of an existing study that explore adequately the morphology of urban spaces and crime pattern in the context of form, scale and time, therefore there is an existing gap in the literature that needs to be filled by future researches so as to provide better understanding of local crime pattern for effective crime prevention and management in our towns and cities.

## **CONCLUSION**

Urban crime has largely been addressed with different approaches to the conception of crime and its main initiatives. However, the growing body of knowledge in the studies of urban crime refers to the social and spatiality aspects of the problem in the cities worldwide. While different approaches to the study of crime do exist as identified in the paper, it is possible to denote that urban crime pattern cannot be thoroughly explored in the absence of social constructs and spatial features of spaces in the context of form, scale and time. Furthermore, the issue of urban crime is multidimensional. That is why any desire for planning and designing a safe place in cities should incorporate functional and morphological analysis of the urban environment. Therefore, there is need for further researches to focus on providing explanation on the relationship between morphological character of spaces and the pattern of crime in places within the context of urban environment. This is with the view of actualizing the Sustainable Development Goals (SDGs) and mainstreaming the mandates of New urban Agenda towards realizing the safe city and crime resiliency in our cities.

## **REFERENCES**

- Abdullah, A., Marzbali, M. H., Bahauddin, A., & Maghsoodi, M. J. (2018). Territorial attitudes and Victimization: A tale of two Neighbourhoods. *Journal of ASIAN Behavioural Studies*, 3(7).
- Ackerman, W. V., & Murray, A. T. (2004). Assessing spatial patterns of crime in Lima, Ohio. *Cities*, 21(5): 423–437.
- Adel, H., Salheen, M., & Aliya, R. A. (2016). Crime in relation to urban design. Case study of the Greater Cairo Region. *Ain Shams Engineering Journal*. Vol. 7, pp. 925-938.
- Ahmed, Y. (2010). Trend and Pattern of Urban Crime in Southwestern Nigeria. Unpublished Ph.D. Thesis, University of Ilorin, Nigeria.
- Alemika, E., & Chukwuma, I. (2012). Criminal Victimization, Safety and Policing in Nigeria. Lagos: CLEEN Foundation.
- Alexander, C., Ishikawa, S., & Silverstein, M. (1977). *A Pattern Language: Towns, Buildings, and Construction*. Oxford University Press, New York.
- Alkim, H. (2006). Urban Morphologic Analyses of Suleymaniye through Space Syntax. An unpublished M.Sc. thesis submitted to the Department of Urban Design, Istanbul Technical University and Institute of Science and Technology.
- Appiahene-Gyamfi, J. (1999). An Exploratory of the Spatial and Temporal Patterning and Distribution of Crime in Ghana with Emphasis on Accra. An unpublished PhD. thesis, Simon Fraser University, Canada.

- Arabi, M., Naseri, T. S., & Jhdi, R. (2020). Use All Generation of Crime Prevention Through Environmental Design (CPTED) for Design Urban Historical Fabric (Case Study: The Central Area of Tehran Metropolis, Eastern Oudlajan). *Ain Shams Engineering Journal*, vol.11, No.3, pp.519-533.
- Armitage, R. (2004). *Secured by Design: An investigation of its history, development and future role in crime prevention*. Unpublished PhD. thesis, University of Huddersfield.
- Arthur, J. A. (1994) *Criminology and crime justice research in Africa: problems and prospects*. *International Review of Modern Sociology*, 24(1), 75 – 94.
- Assiago, J. (2017). *International Approach and Case studies on Safer Cities: A focus on Africa*. A paper presented at the 2017 Town Planners Registration Council of Nigeria (TOPREC) Mandatory Continuing Professional Planning Education Programme (MCPPEP), with the theme: Insecurity, Security and Urban Safety in Nigeria. Held on 5th - 6th April, 2017; at NUT Endwel Conference Hotel, Mogadishu City Centre, Kaduna, Nigeria.
- Azande, P., & Gyuse, T. (2015). *Territoriality and Safety in Urban Residential Neighbourhoods in Nigeria*. Paper presented at the International Crime and Intelligence Analysis Conference, held 26th-27th of February, 2015, at Manchester, UK.
- Bafna, S. (2012a). 'Rethinking genotype: Comments on the sources of type in architecture'. In: *The Journal of Space Syntax*, Vol. 3 (1), p.69-80.
- Bafna, S. (2012b), *The imaginative function of architecture: A clarification of some conceptual issues*. In: Greene, M., Reyes, J. and Castro, A. (eds.), *Proceedings of the Eighth International Space Syntax Symposium*, Santiago de Chile: PUC, pp.8117.1-8117.19.
- Baker, B. (2010). *Non-State Policing: Expanding the Scope for tackling Africa's Urban Violence*. Africa Security Brief No 7.
- Bankoff, G. (1998). *Bandits, Banditry and Landscapes of Crime in the Nineteenth-Century Philippines*. *Journal of Southeast Asian Studies*, vol. 29, No. 2, pp. 319-339.
- Beall, J., & Fox P. (2009). *Cities and Development*. Routledge Perspective on Development.
- Beavon, D. J. K., Brantingham, P. L. & Brantingham, P. J. (1994). *The influence of Street Networks on the Patterning of Property Offences*. In: R. V. Clarke (ed.) *Crime Prevention studies*. Vol. 2, pp. 115-148, Monsey N.Y, Criminal justice Press.
- Bernasco, W., & Block, R. (2009). *Where offenders choose to attack: A discrete choice model of robberies in Chicago*. *Criminology*, vol. 47, pp. 93-130.
- Boivin, R., & D'Elia, M. (2017). *A Network of Neighbourhoods: Predicting crime trips in a large Canadian City*. *Journal of Research in Crime and delinquency*. Vol. 54(6), 824-846, SAGE publishers.
- Boivin, R., & Felson, M. (2017). "Crimes by Visitors versus Crimes by Residents: The Influence of Visitor Inflows." *Journal of Quantitative Criminology*. doi:10.1007/s10940-017-9341-1.
- Bolton, T., Froy, F., Khan, S. S., & Francis, N. (2017). *Crime Policy and Place layout*. Synthesis paper on "The impact of space syntax research on urban policy making: linking research into UK policy. Bartlett Enterprise Development Fund and Space Syntax Limited, UCL.

- Brantingham, P. L., & Brantingham, P. J. (1993a). Environment, routine, and situation: Toward a pattern theory of crime. In R. V. Clarke and M. Felson (Eds.), *Routine Activity and Rational Choice* (pp. 259-294). New Jersey: Transaction Publishers.
- Brantingham, P. L., & Brantingham, P. J. (1993b). Location quotients and crime hotspots in the city. In C.B. Block, & M. Dabdoub (Eds.), *Proceedings of the Workshop on Crime Analysis Through Computer Mapping* (pp. 175). Illinois, August 22 – 25, 1993.
- Brantingham, P. L., & Brantingham, P. J. (1993c). Nodes, paths and edges: Considerations on the complexity of crime and the physical environment. *Journal of Environmental Psychology*, 13: 3-28.
- Brantingham, P. L., & Brantingham, P. J. (1995). Criminality of place: Crime generators and crime attractors. *European Journal on Criminal Policy and Research*, 3(3):5-26.
- Brantingham, P. L., & Brantingham, P. J. (2000). Police use of environmental criminology in strategic crime prevention. *Police Practice*, 1(2): 211-238.
- Brantingham, P. L., & Brantingham, P. J. (2008). The rules of crime pattern theory. In Wortley, R., and L. Mazerolle (Eds.) *Environmental Criminology and Crime Analysis*. Devon, U.K.: Willan Publishing.
- Brantingham, P. L., Brantingham, P. J., Vajihollahi, M., & Wuschke, K. (2009). A topological technique for crime analysis at multiple scales of aggregation. In D. Weisburd, W. Bernasco and G. Bruinsma (Eds.), *Putting Crime in its Place: Units of Analysis in Spatial Crime Research*. London: Springer-Verlag, 87-107.
- Brantingham, P. L., Wuschke, K., Frank, R., & Brantingham, P. J. (2015). Crime emergence and simulation modelling. In McGloin, J. and Kennedy, L. (Eds.). *When Crime Appears: The Role of Emergence*. New York: Routledge, 197-224.
- Bruinsma, G. J. N., Pauwels, L. J. R., Weerman, F. M., & Bernasco, W. (2013). Social disorganization, social capital, collective efficacy and the spatial distribution of crime and offences. *British Journal of Criminology*, 53(5): 942–963.
- Carr, M. M. (2020). *Urban Hostility: CPTED, Hostile Architecture and the Erasure of Democratic Public Space*. An unpublished B.Sc. Architecture Thesis, submitted to School of Architecture, Portland State University, Oregon, USA.
- Ching, F. (1996). *Architecture: form, space and order*, New York, Van Nostrand Reinhold.
- Chiodi, S. I. (2016). Crime prevention through urban design and planning in the smart city era - The challenge of disseminating CP-UDP in Italy: learning from Europe. *Emerald Journal of Place Management and Development*, vol. 9, No. 2, pp. 137-152.
- Clarke, R. V. & Felson, M. (1993). *Routine Activity and Rational Choice*. Vol. 5, New Brunswick and London: Transaction publishers.
- Cohen, L. E. & Felson, M. (1979) Social change and crime rate trends: a routine activity approach. *American Sociological Review*, vol. 44, pp. 588–608.
- Conzen, M.R.G. (1960). "Alnwick, Northumberland: A Study in Town-plan Analysis", Institute of British Geographers Publication 27, George Philip, London.
- Cornish, D. & Clarke, R. V. (1986). *The Reasoning Criminal*. New York, NY: Springer–Verlag.
- Cozens, P. (2007). Planning, crime and urban sustainability. *Sustainable Development and Planning III*, 1: 187-196.
- Cozens, P.M. (2011). Urban planning and Environmental criminology: Towards a new perspective for safer cities. *Planning Practice and research*, 26(4): 481-508.



- Cozens, P.M., Love, T. & Davern, B. (2019). Geographical Juxtaposition: A New Direction in CPTED. *Journal of Social Sciences*, vol.8, No.252, pp.2-22.
- Crowe, T. (2000). *Crime prevention through environmental design*. Butterworth-Heinemann, Stoneham, Massachusetts.
- Curman, A. S., Andresen, M. A., & Brantingham, P. J. (2015). Crime and place: A longitudinal examination of street segment patterns in Vancouver, BC. *Journal of Quantitative Criminology*, 31(1): 127-147.
- Dwidinita, D., Sunarti, E. T. & Setijanti, P. (2018). Understanding the Relationship between Urban Morphology and Crime in South Krembangan, Surabaya. *International Journal of Scientific and Research Publications*; Vol.8, No.7, pp.173-177.
- Eck, E. & Weisburd, D. (Eds.), (1994). *Crime and Place*. Monsey, NY: Willow Tree Press, 67 – 93.
- Eck, J. E., & Weisburd, D. (Eds.). (1995). *Crime prevention studies*. Crime and place, Vol. 4. Monsey, NY: Criminal Justice Press.
- Emmanuel, A. O., Abdul-azeez, S. A. & David A. A. (2015). Spatial Analysis of Factors Responsible for Spread of Crime Activities in Akure, Nigeria, using GIS Techniques. *International Journal of Criminology and Sociological Theory*, Vol. 8, No. 1.
- Erdogan, A., & Erkan, G. H. (2020). Proposal for a Typology in criminology from a Place-oriented perspectives. *Security Journal*, Springer Nature Limited.
- Felson, M. (1995). Those who discourage crime. In D. Weisburd and J. E. Eck (eds), *Crime and Place*, Monsey, New York: Criminal Justice Press, 53–66.
- Felson, M. (1998). *Crime and Everyday Life* (2nd Ed.). Thousand Oaks, California: Pine Forge Press.
- Felson, M. & Clarke, R.V. (1998). Opportunity Makes the Thief: Practical theory for crime prevention. *Police Research Series, Paper 98*. Home Office Policing and Reducing Crime Unit Research, Development and Statistics Directorate.
- Frank, R., Andresen, M. A., & Brantingham, P. L. (2013), Visualizing the directional bias in property crime incidents for five Canadian municipalities. *The Canadian Geographer*, 57: 31.
- Groff, E. R., & Lockwood, B. (2014). Criminogenic facilities and crime across street segments in Philadelphia: Uncovering evidence about the spatial extent of facility influence. *Journal of Research in Crime and Delinquency*, 51(3): 277-314.
- Groff, E., & McCord, E. S. (2012). The Role of Neighborhood Parks as Crime Generators. *Security Journal*, 25: 1.
- Hashim, H., Mohd, W.M.N.W., Sadek, E.S.S.M. & Dinyati, K.M. (2019). Modelling Urban crime patterns using spatial space Time and Regression Analysis. *Proceedings of the 6th International conference on Geomatics and Geospatial Technology (GGT, 2019)*, 1-3 October, 2019, Kuala Lumpur, Malaysia.
- Heidarzadeh, Z. (2014). Achieving Sustainable Urban Security in insecure areas with CPTED approach (Case study: Javadieh Neighbourhood of Bojnourd). *International Journal of Scientific Engineering and Technology*, Vol.3, No.8, pp.1024-1030.
- Hillier, B. & Sahbaz O. (2008). *An Evidence based approach to crime and urban design*. Bartlett School of Graduate University Collage, London.

- Hillier, B., & Shu, S. (2000). Crime and Urban Layout: The Need for Evidence. In S. Ballintyne, K. Pease, & V. McLaren (eds.), *Secure Foundations: Key Issues in Crime Prevention* (pp. 224-248). London: Crime Reduction and Community Safety, Institute of Public Policy Research.
- Hipp, J.R., Kim, Y. & Kane, K. (2018). The effects of the Physical Environment on Crime rates: Capturing housing age and housing type at varying scales. *Journal of Crime and Delinquency*, vol. 65, No. 11, pp. 1-31.
- Isin, C. (2012). *In Between Space and social Interaction: A case study of three Neighbourhoods in Izmir*. Unpublished Ph.D. Thesis, University of Nottingham.
- Jacobs, J. (1961). *The Death and Life of Great American Cities*. New York: Random House. Inc.
- Jones, M., & Fanek, M. (1997). Crime in the urban environment. M.D. Major, L. Amorim, F. Dufoux. *Proceedings, 1st. International Space Syntax Symposium, Vol. II*. London.
- Kamalipour, H. (2016). Urban Morphologies in informal settlements: A case study. *Contour Journal*, vol. 1, No. 2, pp. 1-10.
- Kamalipour, H., Memarian, G., & Faizi, M., (2014). Urban crime and Pattern conceptions: Departuring from Spatiality. *Open Journal of Social Sciences*, vol. 2, pp. 441-450.
- Kim, S., KIM, D. & Jung, S. (2017). Analysis of the effects of Cul-de-sacs permeability factors in Low-rise Residential Areas on Burglary. *Journal of Asian Architecture and Building Engineering*. Vol.16. No.3, pp.487-493.
- Kim, Y. (2018). *Activity Nodes, Pathways, and Edges: Examining Physical Environments, structural Characteristics and Crime patterns in Street segments*. An unpublished Ph.D. thesis submitted to the Department of Criminology, Law and Society, University of California, Irvine, U.S.A.
- Kim, Y. & Hipp, J.R. (2019). Street Egohood: An alternative perspective of measuring Neighbourhood and Spatial pattern of Crime. *Journal of Quantitative Criminology*, springer.
- Kinney, J. B., Brantingham, P. L., Wuschke, K. E, Kirk, M. G, & Brantingham, P. J. (2008). "Crime Attractors, Generator and Detractors: Land Use and Urban Crime Opportunities." *Built Environment* 34:62-74.
- Krieger, A. (2006). Territories of Urban Design, in Moor, M. and Rowland, J. (Eds) *Urban Design Futures*, pp. 18-19. London and New York: Routledge.
- Kropf, K. (1996) "Urban Tissue and the Character of Towns", *Urban Design International* 1, 247-63.
- Kropf, K. S. (2001). Conceptions of change in the built environment, *Urban Morphology*. Vol. 5, No. 1, pp. 29-42.
- Kropf, K. S. (2005). "The handling characteristics of urban form", *Urban Design (Quarterly)*, *Urban Morphology*, Issue 93.
- Kropf, K.S. (1993) "The Definition of Built Form in Urban Morphology", unpublished PhD thesis, University of Birmingham.
- Kumar, M. & Borbor, J. (2018). Urban Crime: A Sociological Study of Johat Town. *IOSR Journal of Humanities and Social Sciences*, vol.23, No.4, pp.53-59.
- Lamya R. T. & Madanipour, A. (2006). Crime and the City: Domestic Burglary and the Built Environment in Tehran. *Habitat International*, 10, 932-944.
- Larkham, P. (2005). "Understanding Urban Form", *Urban Design International*, 93, 22-4.

- Lawanson O.T, Soyinka, O.A & Omole, F.K (2013). Achieving Safety and Security in Nigerian Cities: Matters Arising. Emerging Issues in Urban Planning and Development. Pg. 132-148. Published by, Department of Urban and Regional Planning, Faculty of Environmental Science, University of Lagos.
- Lefèbvre, H. (1991). *The production of space*, Wiley-Blackwell Publishers.
- Legeby, A. (2009). 'From housing segregation to integration in public space'. In: Koch, D., Marcus, L. and Steen J. (eds.), *Proceedings of the Seventh International Space Syntax Symposium*, Stockholm: KTH Royal Institute of Technology, p.065.1-065.12.
- Lin, X. (2010). *Exploring the relationship between Environmental Design and Crime: A case study of the Gonzaga University District*. Unpublished M.sc. Landscape Architecture Thesis, submitted to the Department of Horticulture and Landscape Architecture Washington.
- Lynch, K. (1981). *A theory of Good City Form*, (Cambridge, Mass, London, MIT Press).
- Lynch, K. G. (1960). *The image of the city*. Cambridge, MA: Technology Press.
- Madanipour, A. (1996). *Design of Urban Space: An Inquiry into a Socio-Spatial Process*. John Wiley & Sons Publishers, Chichester, England.
- Marcus, L. (2007). 'Social housing and segregation in Sweden – from residential segregation to social integration in public space'. In: Vaughan, L. (ed.), 'The spatial syntax of urban segregation', in *Progress in Planning*, Vol. 67, p.205-294.
- Marzbali, M.H., Abdullah, A., Ignatius, J., & Maghsoodi, M.J. (2015). Examining the effects of Crime Prevention Through Environmental Design (CPTED) on Residential Burglary. *International Journal of Law, Crime and Justice*, 46(3), 86-102.
- Marzbali, M.H., Maghsoodi, M.J., & Abdullah, A. (2017). Assessing the effect of Neighbourhood structure on residents 'perceptions of safety in gated communities: A case study of Iran. *Safer Communities*, 16(1), 3-19.
- Marzbali, M.H., Abdullah, A., Ignatius, J., & Maghsoodi, M.J. (2016). Examining the effects of Crime Prevention Through Environmental Design (CPTED) on Residential Burglary. *International Journal of Law, Crime and Justice*, 46, 86-102.
- Marzbali, M.H., Abdullah, A., Ignatius, J., & Maghsoodi, M.J. (2019). Ethnic relations, Crime and Disorder in urban Neighbourhoods: Moderating role of Neighbourhood type in Penang, Malaysia, *Security Journal*.
- McCord, E. S., & Ratcliffe, J. H. (2007). A micro-spatial analysis of the demographic and criminogenic environment of drug markets in Philadelphia. *Australian and New Zealand Journal of Criminology*, 40: 43–63.
- McCord, E. S., & Ratcliffe, J. H. (2009). Intensity value analysis and the criminogenic effects of land use features on local crime patterns. *Crime Patterns and Analysis*, 2: 17–30.
- Meena, T. (2016). Crime Prevention Through Environmental Design: A critical perspectives of Environmental Criminology. *International Journal of Law*, vol.2, No.5, pp.1-20.
- Mihinjac, M. & Saville, G. (2019). Third-Generation Crime Prevention Through Environmental Design (CPTED). *Journal of Social Sciences*, vol.8, No.182, pp.1-20.
- Morris, A. E. J. (1994). *History of Urban Form*, Harlow, Longman Scientific and Technical.
- Moudon, A. V. (1997). Urban Morphology as an Emerging Interdisciplinary Field. *Urban Morphology*, 1, 3-10.

- Moudon, A.V. (1998). The Changing Morphology of Suburban Neighbourhoods. *Urban Morphology*, 2, 11-29.
- Nangia, C., Sing, D.P., & Ali, S. (2019). Built Environment and its impact on Crimes related to Women in NCT of Delhi: A pilot Survey. *International Journal of Advanced Research in Engineering and Technology*, vol. 10, NO. 3, pp. 57-68.
- Newman, O. (1996). *Creating defensible space*. US Department of Housing and Urban Development Office of Policy Development and Research. Washington, DC.
- Ojo, A. & Ojewale, O. (eds.) (2019). *Urbanization and Crime in Nigeria*. Published by Palgrave Macmillan, Springer Nature Publishers, Switzerland.
- Owusu, G., Wrigley-Asante, C., Oteng-Ababio, M., & Owusu, A.Y. (2015) Crime prevention through environmental design (CPTED) and built-environmental manifestations in Accra and Kumasi, Ghana. *Crime Prevention and Community Safety*, 17(4): 249–269.
- Perkins, D., Florin, P., Rich, R., Wandersman, A., & Chavis, D. (2009). Participation and the social and physical environment of residential blocks: Crime and community context. *American Journal of Community Psychology*, 18(1), 83e115.
- Perkins, D., Meeks, J., & Taylor, R. (1992). The physical environment of street blocks and resident perceptions of crime and disorder: Implications for theory and measurement. *Journal of Environmental Psychology*, 12(1), 21e34.
- Perry, M.A. (2017). Influence of Physical Design. In Fennelly, L.J. (ed.), *Effective Physical Security*, 5th edition, Elsevier Science and technology Books incorporation, pp. 55-65.
- Psarra, S. (1997). 'Geometry and space in the architecture of Le Corbusier and Mario Botta'. In: Major, M. D., Amorim, L. & Dufaux, D. (eds.), *Proceedings of the First International Space Syntax Symposium*, London: Univesrity College London, p.32.1-32.29.
- Psarra, S. (2009a). 'The ghost of conceived space: What kind of work does or should space syntax perform for architecture?'. In: Koch, D., Marcus, L. and Steen, J. (eds.), *Proceedings of the Seventh International Space Syntax Symposium*, Stockholm: Royal Institute of Technology, p.089.1-089.10 and in *The Journal of Space Syntax [e-journal]*, Vol. 1(1), p.17-29.
- Psarra, S. (2012). Spatial Morphology, Urban history and Design in Julienne Hanson's 'Urban transformation: A history of design ideas. *Journal of Space Syntax*, vol.3, No.1, pp.7-19.
- Ratcliffe, J. H. (2012). The spatial extent of criminogenic places: a change point regression of violence around bars. *Geographical Analysis*, 44(4): 302-320.
- Rengert, G. F. & Brian L. (2009). "Geographical Units of Analysis and the Analysis of Crime." Pp. 109-22 in *Putting Crime in Its Place: Units of Analysis in Geographic Criminology*, edited by D. Weisburd, W. Bernasco, & G. J. N. Bruinsma. New York: Springer.
- Rengert, G.F., Piquero, A.R, & Jones, P.R. (1999). "Distance Decay Reexamined." *Criminology* 37:427-46.
- Salau.T.I & Lawanson T. (2010). Urban Safety Management Approach to Crime Reduction in Lagos Metropolis, in *Urban and Regional Planning Review*. Department of Urban and Regional Planning, University of Lagos 2 (1&2) pp 134 -143
- Salingaros, N. A. (2000). Complexity and Urban Coherence, *Journal of Urban Design*, 5, 291-316.

- Satiawan, P.R., Tucunan, K.P., & Azarine, R.Y. (2018). The Spatial Configuration of crime in Surabaya. *Proceedings of IOP Conference Series: Earth and Environmental Science* 340, pp. 1-14.
- Savoie, J. (ed.) (2008). *Neighbourhood characteristics and the distribution of crime: Edmonton, Halifax and Thunder Bay* (Catalogue No 85-561-M2008010). Ottawa: Statistics. Canada.
- Silva, P. & Li, L. (2020). Urban crime occurrences in Association with Built Environment Characteristics: An African Case with Implications for Urban Design. *Journal of Sustainability*, vol.12, No.3056, pp.1-22.
- Siti R. S. & Abdullah, A. (2012). Measuring Crime Prevention through Environmental Design in a Gated Residential Area: A Pilot Survey, *Social and Behavioral Sciences* 42, pp.340-349
- Song, J., Andresen, M.A., Brantingham, P.L., and Spicer, V. (2016). Crime on the edges: patterns of crime and land use change. *Cartography and Geographic Information Science*, in press.
- Song, J., Spicer, V., & Brantingham, P. (2013a). The edge effect: Exploring high crime zones near residential neighborhoods. In *Intelligence and Security Informatics (ISI)*, 2013 IEEE International Conference on (pp. 245-250). IEEE.
- Song, J., Spicer, V., Brantingham, P. & Frank, R. (2013b). Crime Ridges: Exploring the Relationship between Crime Attractors and Offender Movement. *Proceedings of the European Intelligence and Security Informatics Conference*.
- Suryavanshi, V. M. (2001). *Land use and Opportunities for Crime: Using GIS as an Analysis Tool*. Unpublished Master of Urban and Regional Planning Thesis, Virginia Polytechnic Institute and state university, U.S.A.
- Taylor, R. B. & Harrell, A. V. (1996). *Physical Environment and Crime*. Research report of the National Institute of Justice, U.S. Department of Justice.
- Twinam, T. (2017). Danger Zone: Land use and Geography of Neighbourhood Crime. *Journal of Urban Economics*. Vol. 100, pp. 104-119. <http://dx.doi.org/10.1016/j.jue.2017.05.006>
- Umar. F, Cheshire. J. A, & Johnson. S. D., (2015a). Understanding the spatial pattern of urban crime: a developing country's perspective, the 23rd Conference on GIS Research UK, 15th – 17th April, 2015, University of Leeds, Leeds - UK.
- Umar. F, Johnson. S. D. & Cheshire. J. A, (2015b). Crime and Place: Perspectives from a developing country, The 71st Annual Meeting of American Society of Criminology, 18th – 21st November, 2015, Washington DC, USA.
- Umar. F, Johnson. S. D. & Cheshire. J. A, (2015c). Environmental Criminology: Perspectives from a developing country, The Stockholm Criminology Symposium, 8th – 10th June, 2015, Stockholm – Sweden.
- Umar. F, (2017). Understanding the spatial pattern of urban crime in a developing country. An unpublished Ph.D. Thesis submitted to the Department of Geography, University College of London - UK.
- Umar. F, Johnson. S. D. & Cheshire. J. A, (2018). Testing Theories of Social Disorganization in Nigeria. In Bruinsma, G.J.N. & Johnson, S.D. (eds), *Oxford Handbook of Environmental Criminology*, Oxford University Press, pp.1-28.
- Umar. F, Johnson. S. D. & Cheshire. J.A, (2020). Assessing the Spatial Concentration of Urban Crime: An Insight from Nigeria. *Journal of Quantitative Criminology*. <https://doi.org/10.1007/s10940-019-09448-3>.

- UN-Habitat (2005). Responding to the challenge of an urbanizing World, 2005. Nairobi Kenya: UN-Habitat.
- UN-Habitat (2007). Enhancing Urban Safety and Security: Global Report on Human Settlements 2007. Nairobi Kenya: UN-Habitat.
- UN-Habitat (2016). Urbanization and Development: Emerging futures. World Cities Report, 2016. Nairobi Kenya: UN-Habitat.
- UN-Habitat (2019a). Urban Impact. Issue 08, 4th Quarter report, 2019. pp. 1-4. Nairobi Kenya: UN-Habitat.
- UN-Habitat (2019b). Cities 2030, Cities for All: Implementing the New Urban Agenda. Report of the Ninth Session of the world Urban Forum, held between 7th - 13th February, 2018 at Kuala Lumpur, Malaysia.
- UN-Habitat (2020). World Cities Report 2020. The Sustainable Urbanization. Pp. 6-11. Nairobi Kenya: UN-Habitat.
- Weisburd, D, Groff, E. R, & Sue-Ming Y. (2012). The Criminology of Place: Street Segments and Our Understanding of the Crime Problem. Oxford, England: Oxford University Press.
- Whitehand, J. W. R., (1987). "Background to the Urban Morphogenetic Tradition", J.W.R. Whitehand (Ed.), The Urban Landscape: Historical Development and Management, Institute of British Geographers Special Publication, 13 Academic Press, London, 1-24.
- Whitehand, J. W. R., (2005). "Urban Morphology, Urban Landscape Management and Fringe Belts", Urban Design, 93, 19-21.
- Winton, A. (2004). Urban Violence: A Guide, to the Literature. Environment and Urbanization 16 (2): 165-84.
- World Bank (2011) Violence in the City: Understanding and Supporting Community Responses to Urban Violence, Washington: World Bank.
- Wuschke, K. E. (2016). Planning for Crime: Exploring the Connections between Urban space, Development and Patterns of crime. Unpublished Ph.D. Dissertation, submitted to the School of Criminology, Simon Fraser University, Burnaby, British Columbia, Canada.
- Wuschke, K. E. & Bryan, J. K. (2018). Built Environment, Land use and crime. In Bruinsma, G.J.N. & Johnson, S.D. (eds.). Oxford Handbook of Environmental Criminology. Pp. 1-30.
- Yunusa, M. (2011). Planning Cities for Wealth Creation: Lecture delivered at the First Urban Dialogue Series of Department of Urban and Regional Planning, Faculty of Environmental Sciences, University of Lagos. [www.ccsenet.org/jsd](http://www.ccsenet.org/jsd) Journal of Sustainable Development 5 (2), Feb. 2012 Published by Canadian Center of Science and Education 75.
- Zubairu. A. G. (2016). A comparative study of urban crime between Malaysia and Nigeria. Elsevier Journal of Urban Management. Vol.6, 19-29.



# USERS' ASSESSMENT OF THE RELATIONSHIP BETWEEN HOUSING QUALITY AND THE CONDITIONS OF RESIDENTIAL OUTDOOR SPACES IN ILESA, NIGERIA

Yussuf Shakirat Oladayo<sup>1</sup>, Jiboye Adesoji David<sup>2</sup>, Agbabiaka Hafeez Idowu<sup>3</sup>,  
Adeyemi Toyin Ebenezer<sup>4</sup> and Oke Oluyemi Ebenezer<sup>5</sup>

<sup>1,4</sup>*Department of Architectural Technology, Osun State College Of Technology, Esa-Oke, Nigeria*

<sup>2</sup>*Department of Architecture, Obafemi Awolowo University, Ile-Ife, Nigeria*

<sup>3</sup>*Department of Urban and Regional Planning, Bayero University, Kano, Nigeria*

<sup>5</sup>*Department of Architectural Technology, Federal Polytechnic Ede, Nigeria*

The community space is utilized as a vital strategy for developing housing product. The house and its surroundings directly affect human beings to the extent that it sometimes serves as vital determinants of wellbeing and quality of life. Consequently, this study seeks to understand if there exist a relationship between the condition of residential outdoor space (CROS) and Housing quality (HQ) in Ilesa, Nigeria. The study selected 231 household heads using systematic random sampling technique for questionnaire administration in the study area. The quality of housing and residential outdoor space were assessed using five point likert scale to determine the quality index (QI). Findings revealed that CROS (Condition of residential outdoor space) and HQI (housing quality index) were 3.84 and 3.52 respectively indicating a good condition of housing and residential outdoor space in the area. The study further established a statistical significant relationships between CROS and HQ ( $R^2 = 0.959$ ,  $F(1, 11) = 232.340$ , and  $P \leq 0.000$ ), meaning that 95.9% of the variation in HQ(y) is explained by CROS. Therefore, the outcome of this study could contribute immensely in evolving policies formulation towards improved residential housing design and sustainable city development.

Keywords: building design, housing, quality, residential outdoor space, sustainable development

## INTRODUCTION

An important issue calling for urgent attention from all and sundry is need for qualitative housing and residential environment for the increasing global population. Access to decent and good quality housing has posed a serious challenge to sustainable growth and development. The house and its surroundings

<sup>1</sup> shakymohammed@yahoo.com

<sup>2</sup> jiboye.adesoji@gmail.com

<sup>3</sup> wisdomislife@yahoo.com

<sup>4</sup> ebenadex01@gmail.com

<sup>5</sup> yemiokejr@gmail.com

directly affect human being (Yip, Muhammad and Ching, 2017). In addition, Good quality outdoor spaces in residences contribute to quality of life as well as that of housing (Burton, Mitchell and Griffin, 2014). The general residential environment as well as housing and neighbourhood quality are vital determinants of social class of inhabitants (Ilesanmi, 2012). One of the factors that contribute to healthy status of man is housing condition (Olukolajo, Adewusi and Ogungbero, 2013).

In addition, Fogh and Saransi, (2014) asserted that "architectural design using residential outdoor based approach can be a very effective step towards systematic design of housing". These points emphasized the importance of outdoor space quality to housing and residential environment. Ashley (2018) identified four major parameters of an ideal home as design quality, good environmental conditions, construction quality and a sense of community. This shows that community space is utilized as a vital strategy for developing housing product (Lee, Hyejin and Hyegyong, 2010). An essential aspect of every community, neighborhood and urban design is the outdoor space; consequently, the outdoor spaces are germane feature of every building design (Gray, 2013).

Furthermore, the outdoor space is an important aspect of the residential environment and that of dwellings (Coolen & Menster, 2012). The private residential outdoor spaces are referred to as outer room, especially when they are integrated as part of the inner living areas in building design (Gray, 2013). These outdoor spaces according to Naceur, (2013) are regarded as "natural extension of the interior". Afon and Adebara (2019) noted that these open spaces are integral aspects of the cities that contribute significantly to sustainable urban development.

Moreover, Not only do good quality spaces create a sense of safety and comfort that makes people happy and healthy, but also serve as clean and well preserved areas with easy accessibility for humans to carryout variety of activities(Farr, 2011; Li, & Wu, 2013;Kaźmierczak, 2013; Hadavi, Kaplan, & Hunter, 2015). Despite this, it has been observed that several literatures (Gray, 2013; Olukolajo, et.al 2013; Ilesanmi, 2012; Verissimo 2014; Adeleye 2016; Yussuf, 2018;Olowu, Jaiyeoba, Agbabiaka, & Daramola, 2019;Jiboye, 2004 and Jiboye, 2010 among others)emphasize the importance of good housing quality and residential environment as germane to proper quality of life without actually showing the relationship between the duos. This study therefore, is an effort in this direction.

Conversely, according to Adeleye (2016) among other authors, the provision of qualitative housing and residential environment in some areas in Nigeria still show up as a recurring issue, that may be as a result of residents' socio-demographic peculiarities. The present study attempted answering the following specific questions: who are the residents in Ilesa? What are the conditions of residential outdoor space (CROS) in the study area? What is the overall housing quality (HQ) in the study area? How does CROS influence HQ? It is against this backdrop that this study focuses on users' assessment of CROS and its relationship with HQ in Ilesa, Nigeria; with a view to evolving people's oriented policy response on ROS design.



## LITERATURE REVIEW

### Housing and its components

Housing defies an objective definition because of its multi-faced nature. Extant studies reveal the multi-dimensional nature of housing as follows: according to Jiboye (2010) "housing is conceived as a unit of environment which has a profound influence on health, efficiency, social behavior, satisfaction and general welfare of the community". He added that housing reflects social, economic and cultural values of a society as it showcase the best evidence of a country's physical and historical civilization. Olowuet.al. (2019), conceptualize housing to include three dimensions being environmental (water supply, refuse waste disposal, sewage disposal, roads, drainage (gutter), vehicular circulation, pedestrian circulation, street lighting, car parking, electricity supply, open space(s) and park(s)), external building (renderings and painting, weathered exterior wall finishes, paint decay, removing surface materials, dilapidated roof, broken and leaking soak away, broken and leaking plumbing pipes, broken and leaking water pipes, broken and leaking sewage disposal pipes) and internal building dimensions (ceiling collapse, broken tiles, partial settlement in foundations, sagging beams, broken doors and windows fixtures and leaking roofs). Agbola(1998) defined housing as an array of social, economic, and psychological phenomena; it is a combination of different characteristics to provide a unique home in a neighbourhood. Olatubara (2007) noted that housing has the capacity to influence human being psychologically, culturally, economically politically and socially; it in turn involves material and human resources for its production. Housing is a process and a product (Agbola, 1998). Housing as explained by Jiboye (2009) cited in Adeleye (2016) is one of the best indicators that reveals an individual standard of living and class in the society.

Consequently, housing transcends beyond a mere shelter, it includes quality, comfort, community and social amenities as it embraces all social services (utilizes) that make a neighborhood as well as a community a livable environment (National Housing Policy, 1991). This was corroborated by Existing studies (Adeoye, 2016; Amao, 2012 and Jiboye, 2010) that "housing is a multidimensional package of goods and services that extend beyond shelter itself".So also, according to Eldredge (1967) cited in Adeoye (2016) housing represents "a bundle of goods and services that facilitate and enhances good living; it is a key to neighbourhood quality and preservation".

Ilesanmi (2020) summarized six descriptive dimensions to the concept of housing as functional term, collective term, physical term, professional term, social and political term. The functional term as related to housing entails a physical shelter occupied by a self-selected household for habitation; that is the basic day-to-day human activities of a household occur in this place. Consequently, the collective term of housing relates to collection of residential units with provision of facilities for shared uses.

Ilesanmi (2020) further defined housing as a physical term to mean an incorporation of "attributes of the structures" to reveal its design, size, condition, location, affordability, accessibility, comfort and warmth. Housing as an administrative connotes an active verb that implies day-to-day administration; that is, managing, maintaining and paying for the property. In addition, Ilesanmi (2020)

also explained housing as a professional term to denote "provision, management or maintenance of such structures and their surrounding environment. Lastly, housing as social and political term represents "a focal point for communication between citizens and state; citizens and other people" as well as an "organic hub serviced by a range of professionals and others; that is, parties in the building industry.

### **Residential Outdoor Space (ROS)**

Verissimo (2014) assessed domestic outdoor spaces and described it as multifaceted spaces surrounding the house. These domestic outdoor spaces in the view of (Gray, 2013; Burton, 2014 and Huang, 2005) are also referred to as residential outdoor spaces (ROS). Residential outdoor spaces according to Huang, (2005) are private to residents; they are living spaces that are part of the home; they are activity nodes that provide the greatest opportunity for access and exposure; they in turn, serve as buffer zone between the outside world and housing community. They are also known as private outdoor spaces (Burton et.al, 2014)

Moreover, private outdoor spaces according to Cooper Marcus (2010) are outdoor spaces on a confined area of land owned by individuals such that they are accessible to the owners and invited guests. Gray (2013) defined private outdoor space as a space around the dwelling that is exclusive for the occupants' use. She also asserted that due to numerous uses and values, this type of outdoor spaces are strongly desired by residents' all over the world; because the main purpose of outdoor spaces around building is to provide adequate lighting, ventilation and circulation (Afon and Adebara, 2019). Outdoor spaces in residences are essential part of home and an extension of living space. Extant studies (Canter, 1977; Bonnes & Secchiaroli, 1995; Carr et al, 1992; Dillman & Dillman, 1987; Burgess et al 1988 & Harrison 1983 as cited in Huang, 2005) revealed that these spaces are "interactional spaces, social arena and most valued urban open space because of their familiarity and closeness to homes; this make them more accessible and usable by home residents".

Studies revealed the importance of outdoor spaces in different ways (Coolen & Meester, 2012 and Yussuf, 2018) as it provide residents' with privacy, peace, safety and security; it also attaches value to houses as well as providing safe play area for children, it reflects peoples' identity and symbolizes status. Private residential outdoor spaces provide buffer zones between neighbouring houses. It provides air space for safety and space to keep pets. It contributes to peace and restoration of mind and body; thereby, contributing to health and well-being of residents. It helps residents to escape from stress and intrusion of city life, work and family. It is also helpful in speeding up recovery time from surgery or illness (Cooper-Marcus & Sarkissan, 1986; Frumkin& Fox, 2010; Hall, 2010; Holbrook, 2009; Coolen&Meesters, 2010 and freeman et al., 2012 cited in Gray, 2013).

### **Assessment of Housing and Residential Outdoor Space Quality**

Assessment of housing quality have formed the basis of improvement in housing, this in turn helps to enhance quality of life of residents (Opoko, Oluwatayo, Ezema and Opoko, 2016). Housing quality as noted by Amao (2012) is a function of factors such as "physical condition of the building as well as services and facilities that bring about conducive living in a particular area". Although, quality is a composite

measure; it varies according to contexts (formal/informal housing, urban/rural, developed/developing nations) and conceptually for diverse groups of users (Ilesanmi, 2012). Housing quality is multi-dimensional and dynamic concept subjected to social, behavioural and engineering criteria (Soen 1979 cited in Opoko et.al 2016). Some criteria identified as indicators for quality in the evaluation in residential development as revealed by Adeoye (2016) & Olowu et., al., (2019) to include "aesthetics, ornamentation, sanitation, drainage, age of building, access to basic housing facilities, burglary, spatial adequacy, noise level within neighbourhood, sewage and waste disposal, air pollution and ease of movement among others". Suratkon & Jusoh (2015) defined building design quality as "a combination of functionality, impact and build quality. The commonly used building design quality indicators are also used for housing quality indicators such as; Privacy, Identity/Uniqueness, Comfort, Taste, Accessibility and orientation, Aesthetics, Crime Protection, Connection and Flexibility, Territoriality, Security and safety (Adedeji, 2006; Yussuf, 2018 and Grant-Savela, n.d). Lai, Zhou, Huang, Jiang, Long, and Chen(2014) identified the factors that influence the quality of outdoor space design. Among the factors are functionality, convenience, safety, acoustic environment, aesthetics and air quality. Quality of outdoor spaces (quality indicator) is judged using criteria such as comfort, planning, landscape and design of built structure; visual structure, outdoor livability and level of outdoor activities (Hafiz, 2002). According to Fogh & Saransari (2014) residential quality standard in open spaces relates to issues such as safety, security, tranquility, privacy, solitude and connection with nature. Safety and security, orientation and accessibility, connection and flexibility are identified by Grant-Savela (n.d.) as residential outdoor space quality indicators. Burton et al. (2014) highlighted limitations to maximum utilization quality of outdoor spaces as poor maintenance, unattractiveness and lack of privacy and safety. Mohammed et al. (2014) noted the following as constraints associated with poor quality of residential outdoor environment; they include: lack of security, minimum quality of materials, little or no car park, low quality workmanship and poor maintenance. The study further confirmed the following five indicators by Bonaiuto et. al. (2013) to be evaluated in assessing residential outdoor space design quality. They include safety, level of design, user's friendliness; occupant's involvement in housing and the provided facility.

### **Residential outdoor space and quality of life**

Good-quality places are clean and well preserved areas with easy accessibility for humans to carry out variety of activities. These spaces attract people to use them and help create a sense of safety and comfort that makes people happy and healthy. On the other hand, badly designed and managed spaces can quickly discourage, create eye-sores and attract anti-social behaviours. Lovett, & Chi, (2015), posited in designing outdoor spaces, neighbourhood situations should be adequately considered to increase identity and place attachment. The quality of Outdoor spaces places importance on quality of life in terms of Contact with Nature, Recreation and Leisure, Nature ranging from wilderness to a view of trees and grass in an urban setting, has three systematic, positive effects on people (reduces mental fatigue (Berto, 2014), relieves feelings of stress and arousal due to stress (Bratman, Hamilton, Daily, 2012), and a positive effect on mood (Thompson, Boddy, Stein, Whear, Barton, Depledge, 2011). Contact with nature contributes to

higher quality of life and environment in the following ways: quality of neighbourhood residents, coexistence among families, increase public health and reduce levels of violence and crime in the inner-city (Farr, 2011; Li, & Wu, 2013; Kaźmierczak, 2013; Hadavi, Kaplan, & Hunter, 2015).

Karuppanan & Sivam (2013) posited that outdoor spaces are mostly enjoyed by children, the elderly, and homemakers based on their peculiarities for a broad extent of activities including but not limited to: walking, jogging, cycling, hiking, and playing sports and games. Environmental impact on quality of life is related to quality of its physic and its close relationship with human beings in all dimensions. Outdoor space becomes of a collective nature, a place for mutual communication and social cognition (Peters, Elands, & Buijs, 2010) that meets social and personal daily needs of residents (Ergas, 2010), improve social interactions through a well-designed residential environment (Gehl J., 2011), and encourage face-to-face short-duration outdoor talks and greetings (Finnegan, 2014). The uniqueness of place should be considered in designing outdoor spaces to prevent distortion of norms and values, Social imageability, and neighbourhood's identity of the community (Scarborough, Like-Haislip, Novak, Lucas, Alarid, 2010; Southworth, Ruggeri, 2010). Tuan (2013) believes that people, in an emotional way, have a need to connect to places. For example, residents in the Middle East and the West consider identity to be a part of urban and neighbourhood design (Chiodelli, 2012; Kallus, Kolodney, 2010) and attributed loss of symbols and place identity of the residential environment (Lewicka, 2011; Brugger, Kaiser, Roczen, 2011).

## **MATERIALS AND METHODS**

### **The study area**

Ilesa is a city located in Osun state, south-west, Nigeria. It lies within latitude 70 30' and 70 35' North of the equator and longitude 40 30' and 40 43' East of the Greenwich meridian (Orimoogunje, Oyinloye & Soumah, 2009). Ilesa is an urban area comprising two local government areas (Ilesa East and Ilesa West) located in the eastern part of the state (Ayoola & Amole, 2014). It is an ancient Yoruba city with a typical traditional African setting. It covers a total land area of 113 sq. km (one hundred and thirteen square kilometer).

The city is serves as the zonal headquarters for other Ilesa people found in four other Local Governments Areas of Obokun, Oriade, Atakunmosa west and Atakunmosa east Local Government (Adeleye, 2016). Like other traditional Yoruba city that comprises three major zones or districts of residential developments (Ojo, 1966 and Egunjobi, 1995 cited in Jiboye, 2010). Ilesa consist of the core area, the intermediate zone and the periphery area. The city lies within the rainforest belt of south-west, Nigeria. It is about 32 km from Osogbo, the Osun State capital, 119 km from Ibadan the capital of Oyo State, about 32 kilometers northwest of Ile-ife and 85 km from Akure the capital of Ondo State (Adeleye, 2016). The city is predominantly occupied by traders, public servants, artisans and farmers.

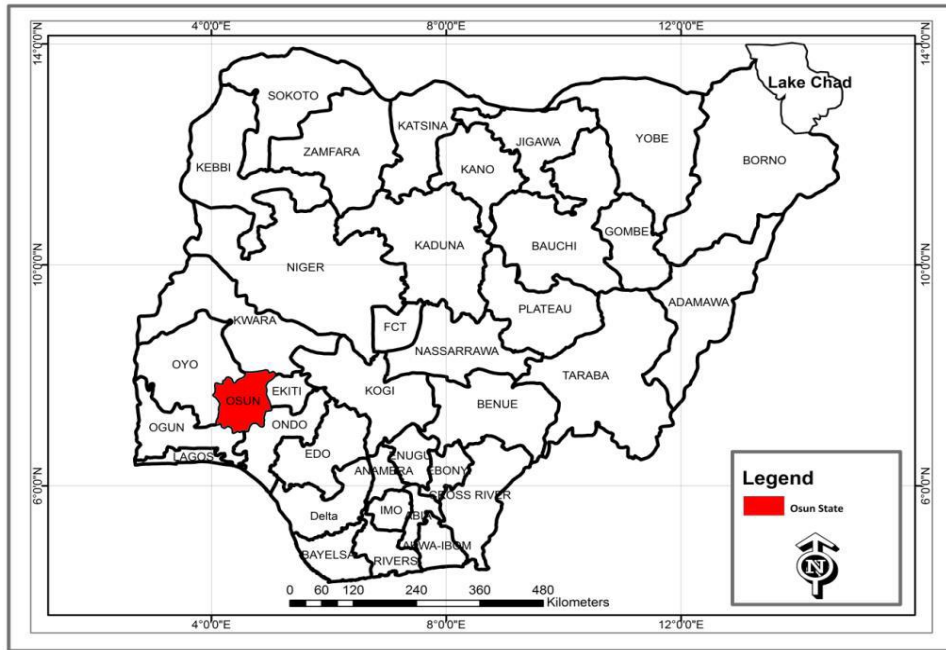

Figure 1: Map of Nigeria Indicating Osun State.

Source: Cooperative Information Network (COPINE), OAU, Ile-Ife 2015

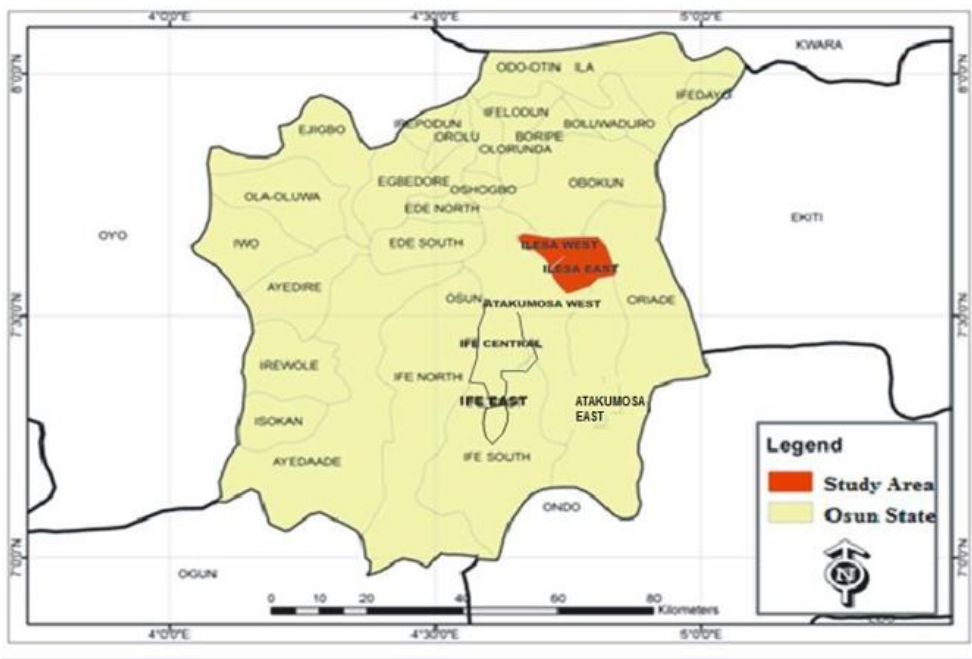

Figure 2: Map of Osun State Indicating the study area (Ilesa).

Source: Cooperative Information Network (COPINE), OAU, Ile-Ife 2015

### Research Design

The study adopted quantitative research design, to elicit information on User's assessment of the relationship between housing quality and the conditions of residential outdoor spaces in Ilesa, Nigeria. Quantitative approach to the study involved the use of questionnaires, which were administered on randomly selected house owners or household heads of residential buildings at the periphery areas of Ilesa city. The information obtained from the questionnaire include: socio-

economic characteristics of the residents, alongside with quality indicators for housing and conditions of residential outdoor spaces. The variables used to determine socio-economic characteristics of residents in the study area are: age, gender, Income, marital status, religion, occupation and Length of stay.

Moreover, the quality of housing and the conditions of residential outdoor spaces was determined by rating residents' perception on a five point Likert's scale from very bad-V.B. (1); bad-B (2); fair-F (3); good-G (4); to very good-V.G. (5). The scale was used to determine the Summation of Weight Value (SWV), Housing Quality Index (HQI) and Condition of Residential Outdoor Space (CROS). The variables used to examine Condition of Residential Outdoor Space (CROS) were: Privacy, Security, Comfort, Air circulation, Accessibility, Natural Energy & Sustainability, parking spaces, Noise level, seating space, Activity space, maintenance and landscape. On the other hand, Housing Quality Index (HQI) was determined using variable such as: floor structure, wall structure, roof, support (column & beams) ceiling, foundation, interior and exterior paints, building services, lighting and ventilation. Other variables are window, door, refuse disposal and drainage. Data were analyzed using descriptive and inferential statistics such as regression and analysis of variance (ANOVA).

### Data Collection

The research survey made use of questionnaire to obtain information on the respondents' housing and outdoor space quality within the study area. The study area (Ilesa) consists of two local government areas with three major residential zones namely the core, transitional and peripheral zones. The peripheral area was chosen for the study out of the three zones in city because they consist of high concentration of housing units with private outdoor spaces as revealed in Table 1.

**Table 1: Categories of residential zones in Ilesa East and West Local Government Area**

S/No	Core Zones	Transitional Zones	Periphery Zones
1.	Ereja, Isida, Adeti.	Egbedi, Ijoka, Ogudu, Ifosan	Oke-Omiru/ Ibala
2.	Ereguru, Isare, Itabalogun	Okesa. Anaye, Oke-eso	Ilaje
3.	Odo-esira, Lemodu, Itisin	Upper and lower Igbogi	Arimoro/Ido-Ijesa,
4.	Itakogun, Isinkin, Ilemo	Igbaye, Odundun/Obokun av.	Imo/omi-asoro
5.	Otapete, Ogudu	Ikoti, ikoyi, Araromi	Irojo/Sabo
6.	Aroaji, Odo-iro	Isokun, Omi-eran, Olorutedo	Bolorunduro
7.		Ijofi, Isona, Orogba, Oke-iro	

Source: Researcher's field work (Yussuf, Jiboye, Agbabiaka and Oyedokun2019)

Housing samples for this study were randomly selected from Imo/Omi-asoro and Ibala/Oke-omiru area, having 9344 and 1373 buildings respectively; making a total of two thousand three hundred and seventeen (2317) buildings. The selected areas also represent a political ward from each local government area of the city as revealed in Table 2. The study adopted systematic sampling technique in which every (10th) tenth building on the street were selected to determine the sample size of 231 buildings where household-heads were sampled for questionnaire

administration, and 205 copies of the administered questionnaire were retrieved representing 88.8% of the sample size.

**Table 2: Political wards and locations in Ilesa east and west local government area**

Political Ward	Ilesa West LGA	Ilesa East LGA
1.	Egbe-idi / Itakogun	Okesa, Obokun Avenue
2.	Cappa / Omi eran	Imo,Omi-asoro
3.	Upper and lower Igbogi	Igbaye, Oke-eso, Ifosan
4.	Omofe / Idasa	Ilemo, Lemodu, Ogudu, Itisin
5.	Isokun/ Oke-omiru / Ibala	Ijamo
6.	Ikoti / ikoyi / Araromi	Ijoka, LejokaAbiola avenue, Ireti Ayo
7.	Ilaje	Iloro, Iroye, Idio
8.	Isida / Adeti	Isare, Orogba, Arogbo
9.	Ereja	Irojo, Sabo, Ilerin
10.	Ayeso / Ido-ijesa	Bolorunduro, Ijofi, Isona, Oke-iro and Itabalogun

Source: Ilesa west and east local government area, 2016.

### Methods of data analysis

Both descriptive and inferential statistics was employ to analyze the data collected. Cross tabulation and percentages was used to analyze the data on socioeconomic characteristics of the respondents (See table 3). The housing quality was examined using the perceptual data derived from likert scale on the rating of the conditions of the attributes to compute the housing quality index (HQI) as presented in Figure 3 and Table 4. Furtherance, regression analyses was employed to establish the relationship between Housing Quality (HQ) and the Conditions of Residential Outdoor Spaces (CROS) with regression model is  $Y = a + bixi$ .

## FINDINGS AND DISCUSSIONS

This section discusses detailed analysis of the data, interpretation and discussions of result findings collected from questionnaire administration on user's assessment of the relationship between housing quality and the conditions of residential outdoor spaces in Ilesa, Nigeria.

### Respondents' Socio-Economic Characteristics

Data on respondents' socio-economic characteristics revealed that there is predominance of male respondents in the study area with (66.8%), married respondents (55.6%), active age population (80.0 %), Christian (56.6%), and Islamic religion (42.4%), Civil servant and students (63.9%), while, majority (66.4%) of the respondents earn between N18,000 to N100,000 and (67.3%) has stayed in the area for less than 10years as presented in Table 4.

**Table 3: Socio-economic Characteristics of Respondents**

Age	Oke-Omiru/ Ibala		Imo/omi-asoro		Total	
	Freq.	%	Freq.	%	Freq.	%
0 to 20 yrs	21	15.4%	13	18.8%	34	16.6%
21 to 40 yrs	84	61.8%	37	53.6%	121	59.0%
41 to 60 yrs	28	20.6%	15	21.7%	43	21.0%
Above 60	3	2.2%	4	5.8%	7	3.4%
Total	136	100%	69	100%	205	100.0%
Gender						

Male	85	62.5%	52	75.4%	137	66.8%
Female	51	37.5%	17	24.6%	68	33.2%
Total	136	100%	69	100%	205	100.0%
Income Distribution						
Below N18,000	36	26.5%	15	21.7%	51	24.9%
N18,001 to N50,000	46	33.8%	29	42.0%	75	36.6%
N50,001 to N100,000	40	29.4%	21	30.4%	61	29.8%
N100,001 to N150,000	7	5.1%	1	1.4%	8	3.9%
Above N150,000	7	5.1%	3	3.3%	10	5.0%
Total	136	100%	69	100%	205	100.0%
Marital Status						
Single	52	38.2%	29	42.0%	81	39.5%
Married	81	59.6%	33	47.8%	114	55.6%
Divorced	1	0.7%	3	4.3%	4	2.0%
Widowed	1	0.7%	3	4.3%	4	2.0%
Separated	1	0.7%	1	1.4%	2	1.0%
Total	136	100%	69	100%	205	100.0%
Religious Affiliation						
Islam	60	44.1%	27	39.1%	87	42.4%
Christianity	74	54.4%	42	60.9%	116	56.6%
Traditional	2	1.5%	0	0.0%	2	1.0%
Total	136	100%	69	100%	205	100.0%
Occupation						
Student	43	31.6%	25	36.2%	68	33.2%
Artisan	6	4.4%	12	17.4%	18	8.8%
Civil Servant	54	39.7%	9	13.0%	63	30.7%
Trading	23	16.9%	13	18.8%	36	17.6%
Retiree	2	1.5%	6	8.7%	8	3.9%
Farmer	2	1.5%	2	2.9%	4	2.0%
Others	6	4.4%	2	2.9%	8	3.9%
Total	136	100%	69	100%	205	100.0%
Length of Stay						
Less than 10years	96	70.6%	42	60.9%	138	67.3%
11 to 20 years	29	21.3%	12	17.4%	41	20.0%
21 to 30 years	9	6.6%	9	13.0%	18	8.8%
Above 30 years	2	1.5%	6	8.7%	8	3.9%
Total	136	100%	69	100%	205	100.0%

### Housing Quality (HQ)

The overall housing quality index (HQI) computed was 3.75. However, Nine out of the seventeen indicators adopted to measure and compute HQI has positive deviation about the HQI, meaning that the individual HQI of the positively skewed indicators were higher than overall HQI; which connotes positive user's perception with varying degrees. The users considered the conditions of Wall, Floor, Foundation, Support services, and Sewage system, Ventilation, Ceiling, External Painting and Roofs of their buildings to be of good quality with varying positive variation about the means of 0.45, 0.31, 0.3, 0.17, 0.17, 0.16, 0.12, 0.11, and 0.05 respectively as presented in table 4. This indicates that the conditions of the building components are relatively good and could be better in the face of appropriate policies on maintenance and management.



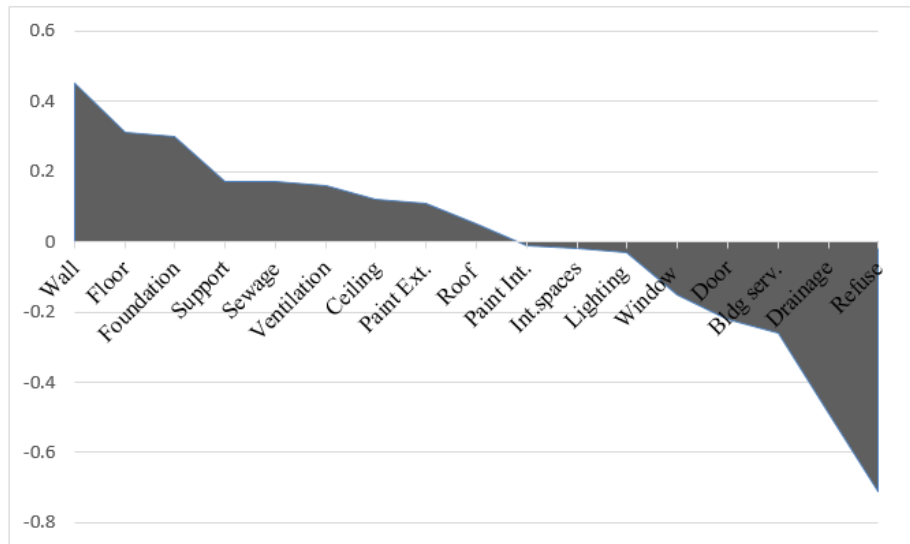

Figure 3: Users' Assessment of housing Quality

Table 4: Users' Assessment of Housing Quality

	VB (1)	B (2)	F (3)	G (4)	VG (5)	SWV	HQI	DEV
Wall	2	19	38	59	87	861	4.2	0.45
Floor	0	5	44	90	66	832	4.06	0.31
Foundation	0	6	23	130	46	831	4.05	0.3
*Support	3	9	53	77	63	803	3.92	0.17
Sewage	3	9	53	77	63	803	3.92	0.17
Ventilation	2	21	34	86	62	802	3.91	0.16
Ceiling	4	11	44	94	52	793	3.87	0.12
*Paint Ext.	0	7	46	121	31	791	3.86	0.11
Roof	1	8	72	73	51	780	3.8	0.05
*Paint Int.	0	13	54	111	27	767	3.74	-0.01
*Int.spaces	4	18	49	93	41	764	3.73	-0.02
Lighting	3	17	57	85	43	763	3.72	-0.03
Window	0	15	86	71	33	737	3.6	-0.15
Door	0	13	99	64	29	724	3.53	-0.22
*Bldg serv.	9	13	92	53	38	713	3.49	-0.26
Drainage	12	29	84	53	27	669	3.26	-0.49
Refuse	23	37	75	48	22	624	3.04	-0.71
Total	66	250	1003	1385	781	13057	59.78	

Please Note: VB= Very Bad (1), B= Bad (2), F= Fair (3), G= Good (4) and VG= Very Good (5). \*Support = Beams and column, \*Paint Ext. = Exterior Painting \*Paint Int. =Interior Painting \*Int.spaces=Interior spaces and \*Bldg serv.= Building Services, Cut-off point= 3.52

### Conditions of Residential Outdoor Spaces (CROS)

The ROS quality was assessment using a number of variables derived from literature as attributes. Twelve (12) attributes were examined through the perception of the inhabitants of the environment. The inhabitants rates five attributes very highly, which connotes that they have strong positive perceptions about their conditions. These attributes are Privacy (CROSI = 4.25, and DEV= 0.41), Comfort (CROSI = 4.19, and DEV= 0.5), Security (CROSI = 4.05, and DEV= 0.21), Air space (CROSI = 3.92, and DEV= 0.08), and Activity space (CROSI = 3.85, and DEV=

0.01). On the contrary, it can be deduced from the findings that the ROS are not freely accessible, maintained; good as parking space, properly landscaped and generate much noise. This was evident from the findings as present in table 5. Invariably, the conditions of ROS may play a lead role in shaping the portion of people about the overall housing quality. Hence, the need to assess the relationship between conditions of ROS and the overall housing quality: using the conditions to predict housing quality.

**Table 5: Assessment of the Use of Residential Outdoor Spaces**

	VB (1)	B (2)	F (3)	G (4)	VG (5)	SWV	ROSI	DEV.
Privacy	2	2	27	85	89	872	4.25	0.41
Comfort	0	1	38	87	79	859	4.19	0.35
Security	2	5	44	83	71	831	4.05	0.21
Air space	3	7	45	99	51	803	3.92	0.08
Activity space	1	13	56	80	55	790	3.85	0.01
Accessibility	0	8	51	114	32	785	3.83	-0.01
Maintenance	4	11	63	77	50	773	3.77	-0.07
Parking space	8	13	53	85	46	762	3.72	-0.12
Circulation	5	16	60	86	38	751	3.66	-0.18
Natural energy	4	9	70	95	27	745	3.63	-0.21
Landscape	3	19	60	97	26	737	3.60	-0.24
Noise level	3	23	72	73	34	727	3.55	-0.29
Total						9435	46.02	

Please Note: VB= Very Bad (1), B= Bad (2), F= Fair (3), G= Good (4) and VG= Very Good (5), ROSI= Residential Outdoor Space Index, and DEV= Deviation about the Mean, Cut-off point= 3.84

### Relationship between the Conditions of Residential Outdoor Spaces and Housing Quality

The identified attributes such as wall, floor, foundation, support services, sewage, ventilation, ceiling, paint external, roof, paint internal, lighting, window, door, drainage and refuse, which were adopted to compute HQI were summed together and categorized as the dependent variable (y), while the variables for measuring the CROS were also summed as independent variable (x). Findings presented in Tables 6 to 8 revealed the multiple regression model that produced  $R^2 = 0.959$ ,  $F(1 \text{ and } 11) = 232.340$ , and  $P \leq 0.000$ . This indicates that the overall model is statistically significant. The regression ( $R = 0.979$ ) indicated that there exists a strong positive correlation between Conditions of Residential Outdoor Spaces (CROS) and Housing Quality (HQ). The coefficient of determinations is 0.959, meaning that 95.9% of the variation in Housing Quality(y) is explained by Conditions of Residential Outdoor Spaces. Therefore, it is conclusive that the predictor is useful for predicting Housing Quality in the study area.

**Table 6: Regression model summary**

Model	R	R Square	Adjusted R Square	Std. Error of the Estimate
1	.979a	.959	.955	.03136

a. Predictors: (Constant), CROSI

**Table 7: Anova**

Model		Sum of Squares	df	Mean Square	F	Sig.
1	Regression	.229	1	.229	232.340	.000a
	Residual	.010	10	.001		
	Total	.238	11			

a. Predictors: (Constant), CROSI

b. Dependent Variable: HQ

**Table 8: Coefficient of regression**

Model		Unstandardized Coefficients		Standardized Coefficients		
		B	Std. Error	Beta	T	Sig.
1	(Constant)	1.488	.158		9.394	.000
	CROSI	.629	.041	.979	15.243	.000

Dependent Variable: HQI

$$\text{Housing Quality}(Y) = 1.488 + (0.629 \times \text{CROSI})$$

## CONCLUSION

This paper examined users' assessment of the relationship between housing quality and the conditions of residential outdoor spaces in Ilesa, Nigeria. It showed that houses with well-defined residential outdoor space perhaps gated and fences have a good quality assessment by the users. Findings of this study also revealed that users (respondents) rated comfort, privacy, security and air space high; it showed that these quality indicators are more preferred by the users compared to other quality indicators. This was confirmed by (Gray, 2013) that provision of good quality residential outdoor spaces should follow basic urban design principles such as flexibility of space for diverse activities and privacy.

Similarly, the study established a strong positive correlation between housing quality and the condition of ROS in the study area. This is an indication that the nature of the environment in which a house is located influences the perception on its quality. This assertion does not only provide basis for prevention of poor quality of housing and residential outdoor space quality but also to save the built environment as it will in turn aid sustainable environmental development. Consequently, it will go a long way in improving the life expectancy as well as quality of life of an average citizen (Amao, 2012).

However, this study is limited to users' assessment of the relationship between housing quality and the conditions of residential outdoor spaces. Other studies can also research into other topical issues in outdoor spaces such as satisfaction with outdoor spaces, preferences for different types of outdoor spaces, usability of outdoor spaces for different age groups, spatial standards in residential outdoor spaces, outdoor spaces and quality of life among others.

The study has become imperative as it shows the link between housing quality and residential outdoor spaces to guide policy response in achieving sustainable development. The study concludes that residents' views and participation are highly recommended to facilitate successful policy formulation and implementation.

## REFERENCES

- Adeleye, O. (2016). Evaluation of tenants' satisfaction with rental housing in Ilesa, Osun State, Nigeria. *International Journal of Economics, Commerce and Management* 4(8)August, 2017 ISSN23480386 available at [www.ijecm.co.uk](http://www.ijecm.co.uk)
- Adeoye, D. O. (2016). Challenges of urban housing quality: insights and experiences of Akure, Nigeria. *Urban Planning and Architecture Design for Sustainable Development, UPADSD 14- 16 October 2015Procedia - Social and Behavioral Sciences* 216 pp.260 – 268
- Afon, A. O. and Adebara, T.M. (2019).Socio-cultural usage of building setback as open space in the core residential area of Ota, Nigeria: implications for physical planning. *Proceedings of Environmental Design and Management International Conference "EDMIC 2019"* pp308-319 ISSN 2682-6488.
- Agbola, T. (1998). *The Housing of Nigeria: A Review of Policy Development and Implementation*, Research Reports No. 14, Development Policy Centre, Ibadan.
- Aktacir, M. A.,Buyukalara, O., Buhit, H., and Yilmaz, T. (2008). Influence of different outdoor design conditions on design cooling load and design capacities of air conditioning equipments. Accessed on 30th September, 2016.
- Amao, F. L. (2012). Urbanization, housing quality and environmental degeneration in Nigeria. *Journal of Geography and Regional Planning* 5(16), pp.422-429, DOI:10.5897/JGRP12.060ISSN 2070-1845©2012 Academic Journals.
- Ashley, B. P. (2018). Residential design quality research report. Hoarelea research, [hoarelea.com](http://hoarelea.com) accessed on 6th January, 2021.
- Ayoola, A. and Amole, D. (2014). The value of housing among the poor in Ilesa, Osun State Nigeria, *Architecture Research* 4(1A),pp. 45-54. doi: 10.5923/s.arch.201401.06.
- Bahar, F.F., Santosa, H.R. and Antaryama, I.N. (2005). Landscape architecture as a factor in the formation of thermal system of residential areas. Accessed on 29th September, 2016.
- Berto R. (2014),The role of nature in coping with psychophysiological stress: a literature review on restorativeness. *Behavioral sciences*. 4, 394
- Bratman G.N., Hamilton J.P., Daily G.C. (2012). The impacts of nature experience on human cognitive function and mental health. *Annals of the New York Academy of Sciences*. 1249, 118
- Brugger A., Kaiser F.G., Roczen N. (2011). One for All? *European Psychologist*.
- Burton, E., Mitchell, L. & Griffin A. (2014). Do garden matter? The role of residential outdoor space. I'DGO publication, WISE (wellbeing in sustainable environment) University of Warwick
- Chiodelli F., (2012). Planning illegality: The roots of unauthorised housing in Arab East Jerusalem. *Cities*. 29, 99
- Coolen, H. and Meesters, J. (2012). 'Private and public green spaces: meaningful but different settings', *Journal of Housing and the Built Environment* 27(1),pp.49-67.

- Cooper-Marcus, C. (2010). Shared outdoor space and community life; *Place Journal* 15(2), pp. 31-41.
- Cooper-Marcus, C. (2012). 'Planning for a silent minority: the needs of children for outdoor play, access to nature, and independent mobility', *Sustainable urbanism and beyond: Rethinking cities for the future*, New York: Rizzoli, pp. 219-224.
- Court, C. (2004). Open space, Sport and Outdoor Recreation Planning Policy Statement (PPS8) The Planning Service: an agency with the department of the environment [www.doeni.gov.uk](http://www.doeni.gov.uk) accessed 23rd February, 2017
- Emenike, A.I. (2012) Urban open spaces; luxury or necessity In: Laryea, S., Agyepong, S.A., Leiringer, R. and Hughes, W. (Eds) *Proceedings of 4th West Africa Built Environment Research (WABER) Conference, 24-26 July 2012, Abuja, Nigeria*, pp. 521-521.
- Ergas C. A., (2010). model of sustainable living: Collective identity in an urban ecovillage. *Organization & Environment*. 23, 32
- Farr D., (2011). *Sustainable urbanism: Urban design with nature*. John Wiley & Sons.
- Finnegan R, (2014). *Communicating: The multiple modes of human communication*. Routledge
- Fogh, A.O. and Saransi, F.S. (2014). The role of open residential complexes and its impacts on peoples live. *Advanced environmental biology AENSI Journals* 8(16),pp. 628-635
- Gehl J., (2011). *Life between buildings: using public space*. Island Press
- Gray, K. (2013). Are outdoor spaces important? An investigation into the provision of outdoor space for medium density housing developments. A thesis submitted in partial fulfilment for the degree of Master of Planning University of Otago, Dunedin, New Zealand.
- Grant-Savelle S. (N.D.). Outdoor spaces. Retrieved from [https://www.4uwm.edu/dementiadesign/info/data/white\\_papers/outdoor.spacespdf](https://www.4uwm.edu/dementiadesign/info/data/white_papers/outdoor.spacespdf). Accessed on 11th February, 2017.
- Green, K. and Vergragt, P. (2002). *Towards sustainable households: a methodology for developing sustainable technological and social innovations* available at [www.elsevier.com](http://www.elsevier.com) accessed on 29th January, 2017.
- Griffin, A.C. (2012). Shared residential outdoor space: what residents do there and the features that support high levels of usage. A thesis submitted for the degree of Doctor of Philosophy in Engineering, University of Warwick, United Kingdom.
- Hadavi S., Kaplan R., Hunter M.C.R., (2015). *Environmental affordances: A practical approach for design of nearby outdoor settings in urban residential areas*. *Landscape and Urban Planning*. 134, 19
- Hafiz, R. (2002). Comfort and quality of indoor and outdoor spaces in semi-tropical humid city: an analysis of urban planning and design. Retrieved from [http://p20017719.eng.ufjfibr/Public/AnaisEventoscientificos/PLEA\\_2002/4\\_COMFOR QUALITY/HAFIZ.PDF](http://p20017719.eng.ufjfibr/Public/AnaisEventoscientificos/PLEA_2002/4_COMFOR QUALITY/HAFIZ.PDF). Accessed on 21st February, 2017.
- Huang, S.L. (2005). A study of outdoor interactional spaces in high-rise housing.

- Journal of Landscape and Urban Planning 78 (1),pp 193-204. Hong Kong Planning Standard and Guidelines (2015). Online: Planning department, the government of the Hong Kong special administrative region "Recreation, Open space and Greening" retrieved from [www.pland.gov.hk/pland\\_en/tech\\_doc/hkpsg/full/ch4/ch4\\_text.htm](http://www.pland.gov.hk/pland_en/tech_doc/hkpsg/full/ch4/ch4_text.htm) accessed on 12th November, 2016.
- Ilesanmi, A. O. (2012). Housing, neighbourhood quality and quality of life in public housing in Lagos, Nigeria. *International Journal for Housing Science*, 36(4), pp.231-240.
- Ilesanmi, A.O. (2020). Exploring the universe of housing research: sustaining architecture's space. NIA E-lecture Series #17 delivered on 2nd September, 2020.
- Jiboye, A.D. (2004). The socio-cultural responsiveness of household size on housing quality in Osogbo, Nigeria. *Journal of Anthropologist*, 6(3), pp.169-174 (2004).
- Jiboye, A.D. (2010a). Evaluating the Pattern of Residential Quality in Nigeria: The Case of Osogbo Township. *FactaUniversitatis architectural and civil engineering Journal* 8(3), pp. 307-316. DOI: 10.2298/FUACE1003307J
- Jiboye, A.D. (2010b). Evaluating user's household size and housing quality in Osogbo Nigeria. *Frontiers of Architectural research*, 3(2) pp. 9-17
- Kallus R., Kolodney Z., (2010). Politics of urban space in an ethno-nationally contested city: negotiating (co) existence in WadiNisnas. *Journal of Urban Design*. 15, 403
- Karuppannan S., Sivam A., (2013). Comparative analysis of utilization of open space at neighbourhood level in three Asian cities: singapore, delhi and kualalumpur. *Urban Design International*. 18, 145
- Kaźmierczak A., (2013). The contribution of local parks to neighbourhood social ties. *Landscape and Urban Planning*. 109, 31
- Kenawy, I., Affi, M. and Mahmoud, A. (2010). The effect of planting design on thermal comfort in outdoor scape. A paper delivered at first international conference on sustainability and the future FISC accessed on 29th November, 2016.
- Lai, D., Zhou, C. Huang, J., Jiang, Y., Long, Z., and Chen, Q. (2014). Outdoor space quality: a field study in an urban residential community in central China. *Energy and Buildings*, Vol.68 No. 1. Part B, pp.713-720.
- Lewicka M., (2011). Place attachment: How far have we come in the last 40 years? *Journal of Environmental Psychology*. 31, 207
- Li Z., Wu F., (2013). Residential satisfaction in China's informal settlements: A case study of Beijing, Shanghai, and Guangzhou. *Urban Geography*. 34, 923
- Lovett M.G., Chi Y.N., (2015). Place attachment among college students related to community engagement through service-learning. *International Journal of Education Research*. 10
- Naceur, F. (2013). Effect of outdoor shared spaces on social interaction in a housing estate in Algeria. *Elsevier frontiers of architectural research*, 2(4), pp. 456-467.
- Olatubara, C.O. (2007). Housing Maintenance: Housing Development and Management: A Book of Readings, Chapter 12. Department of Urban and Regional Planning, Faculty of social sciences, University of Ibadan, Ibadan, Nigeria, Malijoe soft print, Ibadan.
- Olowu F.Y., Jaiyeoba, E. B., Agbabiaka H. I., Daramola O. J., (2019) "Spatial analysis of the factors influencing housing quality for renters in a traditional Nigerian city", *International Journal of Housing Markets and Analysis*, Vol. 12 Issue: 2, pp.181-209, <https://doi.org/10.1108/IJHMA-04-2018-0027>

- Olukolajo, M.A., Adewusi, A.O. and Ogugbenro, M.T. (2013), "Influence of housing condition on health status of residents of urban core of Akure, Nigeria", *International Journal of Development and Sustainability*. 2(2), pp. 1567-1579.
- Opoko, A.P., Oluwatayo, A.A., Ezema, I.C. and Opoko, C.A. (2016). Residents' perception of housing quality in an informal settlement. *International Journal of Applied Engineering Research*, Vol. 2 Issue: 4, pp. 2523-2534 ISSN 0973-4562.
- Orimoogunje, O.O.I., Oyinloye, R.O. and Soumah, M. (2009). "Geospatial Mapping of Wetlands Potential in Ilesa, Southwestern Nigeria" TS 4B – SDI in Municipality and Natural Resources Management FIG Working Week 2009 Surveyors Key Role in Accelerated Development Eilat, Israel, 3-8 May 2009 pp. 1-19.
- Peters K., Elands B., Buijs A., (2010). Social interactions in urban parks: Stimulating social cohesion? *Urban forestry & urban greening*. 9, 93
- Scarborough B.K., Like-Haislip T.Z., Novak K.J., Lucas W.L., Alarid L.F., (2010). Assessing the relationship between individual characteristics, neighborhood context, and fear of crime. *Journal of Criminal Justice*. 38, 819
- Southworth M., Ruggeri D. (2010). *Place, Identity And The Global City. Urban Design Companion* London: Routledge
- Suratkon, A. and Jusoh, S. (2015). Indicators to measure design quality of buildings. First international conference on science, engineering and environment, Tsu city, Mie, Japan Nov. 19 -21, 2015. Available at <https://www.researchgate.net> accessed on 26th February, 2017.
- Thompson C.J., Boddy K., Stein K., Whear R., Barton J., Depledge M.H. (2011). Does participating in physical activity in outdoor natural environments have a greater effect on physical and mental wellbeing Evidence of Poor Environments in Shared... 1345 than physical activity indoors? A systematic review. *Environmental science & technology*. 45, 1761
- Tuan Y.-F., (2013). *Topophilia: A study of environmental perceptions, attitudes, and values*. Columbia University Press
- Verissimo, C. (2014). The significance of outdoor domestic space for an eco-development model of medium-size cities: a case study of Dondo, Mozambique available at [www.ecee/fileadmin/Defining\\_the\\_outdoors\\_en.pdf](http://www.ecee/fileadmin/Defining_the_outdoors_en.pdf) accessed on 4th February, 2017.
- Yip, M.N., Muhammad, J. and Ching, G.H. (2017). Indicators of sustainable housing development (SHD): A review and conceptual framework. *International Journal of Scientific and Engineering Research* Vol.8 Issue: 9, pp. 306-316 ISSN 2229-5518.
- Yussuf, S.O. (2018). Evaluation of Characteristics and Quality of Residential Outdoor Spaces in Ilesa, Nigeria. An unpublished M.Phil Thesis, Department of Architecture, Obafemi Awolowo University, Ile-Ife.
- Yussuf, S.O., Jiboye, A.D., Agbabiaka, H.I. and Oyedokun, A.A. (2019). An Assessment of Characteristics and Qualities of Residential Outdoor Spaces in Ilesa, Nigeria. *The International Journal of the constructed Environment* Vol.10 Issue: 3, pp.11-28, <https://doi.org/10.18848/2154-8587/CGP/v10i03/11-28>



# WATER ABSORPTION QUALITY OF CLAY BRICKS MADE BY EMERGING MANUFACTURERS IN SOUTH AFRICA

Bonga PraiseGod Khuzwayo<sup>1</sup>

*Department of Civil Engineering and Geomatics, Durban University of Technology, South Africa*

Masonry walling comprising clay units in South Africa is required to comply with SANS227, in addition to other South African National Standards. The water absorption quality of clay masonry is an important characteristic since it determines the flexural strength of masonry walls. The prevalence of substandard materials and the inability to enforce construction standards by statutory bodies and the existing legislation in South Africa (SA) creates a breach between the intentions of the designer and what can be achieved physically on site. Two sites in Qwaqwa and Newcastle, South Africa, where clay bricks are manufactured by the community, were identified. From these sites, 11 samples of each unit type, namely; low (11 number off) and high (11 number off) burnt units were purchased from each site over a 12-month period. These samples were newly made clay bricks. A total of 264 units per site (11 units x 2 types x 12 months) were purchased from developing/local entrepreneurs/manufacturers, for testing for the water absorption quality. Considering only the manufacturing site and the water absorption of brick purchased from them, they produced the following results: (1) Qwaqwa had 27.3% with a standard deviation of 6.6; (2) Madadeni had 34.3% with a standard deviation of 9.6. In view of the site only and with respect to the brick type, the investigation yielded the following means: (1) Qwaqwa had 32.2% with a standard deviation of 7.5 which means that the data is more spread out; (2) Madadeni had 29.4% with a standard deviation of 10.1, which means that the data is more spread out. Even though hard burnt has a slightly higher value than low burnt, the difference in the water absorption is not significant ( $p = 0.287$ ). Besides the water absorption quality being far above the recommended range of between 12% and 20%, the water quality varies significantly. Citizens who purchase clay bricks for the construction of their homes have little or no knowledge of the hidden water absorption quality problem which significantly affects the flexural strength of structural elements, such as cantilevered masonry retaining walls and walls required to have flexural strength. The South African Bureau of Standards must enforce good quality of clay bricks made by emerging manufacturers in South Africa.

Keywords: clay bricks; flexural strength, masonry walling, water absorption quality

## INTRODUCTION

Stiff, sticky, fine-grained soil, such as clay, is molded when wet, dried and baked to make masonry units such as bricks and blocks, pottery and/or other ceramic items. They consist of extremely fine particles, making them immensely flexible when wet.

---

<sup>1</sup> bongak@dut.ac.za



'Brick' as a term, covers an extensive number of products produced through the mixture of clay, composing and shaping it, before drying it slowly and then baking it, in an oven or fire source. Mineralogical and textural fluctuations transpire as the temperature increases (Cultrone and Sebastián, 2009). Clay units are the most popular building material in the construction industry, having been used for over a thousand years (Al-Sibahy and Edwards, 2017). However, according to tests done on prehistoric fired bricks and pottery remains in kiln-like structures from the Middle Neolithic archaeological site of Xinjie in Shaanxi Province, in China, the construction of clay bricks in East Asia started about 5000-5300 years ago, which seems earlier than initially assumed. The sporadic occurrence of different size fired clay bricks suggests that it was not until the Qin Dynasty that bricks, made with locally available loess, were widespread (Yang et al., 2014).

There are other types of masonry units manufactured, using various materials and techniques, such as adobe. This is an earth brick/block indigenously made using natural soil and fibre materials. It is widely utilised in developing countries, such as China, India, Iran, Turkey and Botswana (Wu et al., 2013). In fact, China has been using adobe to build houses from as early as the Shang dynasty (1500 -1000 B.C.), showing that adobes have been utilised in the construction industry for thousands of years. Earth brick/block construction is commonly found in less-developed countries where it is often used to imitate sturdier structures using unreliable building materials. The use of adobe is associated with low income status. The existence of earth brick construction dates from the early agricultural societies that existed, according to our present understanding, from around 12,000 to 7000 BC. Although this material is associated with low income status, it is also found in developed countries, where there is a growing consciousness of the significance of earth construction (Pacheco-Torgal and Jalali, 2012).

Clay bricks are utilised for various purposes ranging from residential, and commercial to public buildings (Molnár and Larsson Ivanov, 2016). Their core function is that of walling up a building to provide usable safe and comfortable space. Masonry walls are made up of arranged bricks/blocks that are attached to each other through a mortar bed and head joints (Noor-E-Khuda and Albermani, 2019). Burned clay bricks are common in South Africa and are used as reinforced or unreinforced walling, with unreinforced being popular. Unreinforced masonry walls can be used as both structural and non-structural walls in the construction industry (Li et al., 2017). Clay bricks are required/expected to have a water absorption capacity of 12% to 20%. However, 12% has been proven to be the ideal water absorption capacity when using engineering units (The Clay Brick Association of Southern Africa, 2021). An adequate bonding between clay units and mortar is needed to execute a design, safely, depending on the flexural strength (Rao et al., 1996). Tests have shown that moisture affects mechanical properties of brick, mortar and masonry, notably decreasing the compressive strength of a brick and cement mortar. Some of the attributes that make clay units common, in addition to their better performance when compared to other construction materials, include compressive strength, durability, thermal and acoustic insulation, fire insulation and classical appearance.

Clay units are believed to provide employment opportunities for both skilled and unskilled labour, which makes them popular in countries with developing

economies. Their excellent thermal mass affords them the ability to absorb mass-energy during the day and to release it at night, smoothing the high-temperature variations (Al-Sanea et al., 2013). This is important because over 30% of primary energy is consumed by structures to preserve their indoor temperature, which changes due to heating and cooling losses (Rashid et al., 2019). The construction industry is known to provide many employment opportunities for both experienced and inexperienced, professional and unprofessional individuals (Marglin, 2017). With the ever-increasing demand for construction work, some individuals have identified new business opportunities, while others have tried to produce some of the materials themselves. It is for this reason there is a surge in people working at the micro, small and medium to large operations making construction materials such as clay bricks. However, understanding is needed as to how the construction industry is supposed to function with regard to providing good-quality materials which includes the role they play in legislation compliance, in the provision of safe structural environments and quality systems. The majority of manufacturers do not possess the required knowledge and skills, which has resulted in the production of poor-quality clay units. South Africa is no different from other countries such as Zimbabwe, as indicated in Figure 1 taken by the first author during an exploratory study in SADC countries.



Figure 1. Manufacturers of clay bricks in Zimbabwe

Manufacturing construction clay materials, such as bricks, tiles and blocks, by firing is the most beneficial method in the industry when compared to other methods such as cementing, and this, it is believed, will last for the next two decades (Monteiro and Vieira, 2014). The core challenge for the masonry industry is the shortage of skilled artisans that are capable of providing quality construction work (Bosiljkov et al., 2010). Furthermore, the quality of materials and production procedures are compromised by manufacturers who do not comply and use substandard materials (Day, 2011).

## LITERATURE REVIEW

Bricks are divided into two types: material-oriented and process-oriented bricks. The process of producing clay bricks consumes enormous amounts of energy whilst producing a significant carbon footprint, as it involves firing. On the other hand there are cement products such as cement bricks (and blocks) which also face challenges. Future research in the construction of bricks faces a challenge of skepticism towards innovative bricks, as cement and lime-based calcium-silicate-

hydrate bricks have proven to be unsustainable (Zhang et al., 2018). The majority of low-cost and original construction materials (such as unburned clay bricks) have been shown to be interestingly low on carbon, easily accessible, and less waste-handling issues (Nordby and Shea, 2013). With respect to burnt bricks, the kiln firing, where the ultimate properties of the brick are achieved, is regarded as a highly complex process in brick making. However, the drying process has also presented its own set of composite processes and problems that prove difficult for the operator to control, making it equally complex in firing. Drying has proven to cause defects that cannot be fixed by firing (Slevin and Whalen, 1998).

Mechanical behaviour of the bricks manufactured by old-style technologies using high-temperature exposure depends on the quality of the firing. The high porosity and low density of bricks from traditional technologies induce low thermal conductivities which limits the effects of heat on the material. Such low quality bricks should be used as siding and filling elements in structures and they are not suitable for structural purposes (Bidoung et al., 2016). Clay bricks consume an enormous amount of clay, which contributes to environmental degradation, as large amounts of clay soil have to be mined. The mining process affects the soil and vegetation, thus when done carelessly/excessively without rehabilitation steps being taken, soil erosion is the result (Santhosh et al., 2013). Many regions in the world have limited natural resource material for producing the traditional bricks, which presents a threat to the environment and to sustainable development (Zhang, 2013).

The bond strength is greatly affected by the water absorption of the brick components and mortar paste during construction. Moisture curing of the wall after construction also affects the strength. This was demonstrated by undertaking, in-plane shear and out-of-plane bending tests conducted on multiple brick wallets and infills, built with different pre- and post-construction moisture conditions (Maheri et al., 2011). It may be assumed that values of bond strength quality are directly influenced by compression strength but bond strength has proven to be closely related to the coarseness of the substrate, the petrographic features of the stone, the water absorption of the substrate, and to the grout applied (Luso and Lourenço, 2017). The strength of the mortar mix is important as it affects the strength of structural elements made of masonry. To give an example, the utmost strength or moment-carrying capacity of a masonry beam is greatly affected by the strength of the grout, verified by the sensitivity analysis (Zohreh Heydariha et al., 2017). The design of walls made with clay units, however, is different. Designers prioritise specifications for the water absorption, deemed critical in this case, as the bond mechanism between clay bricks and mortar yields dissimilar flexural strengths for numerous types of mortar class (Crofts and Lane, 2011). This is indicated in Figure 2 of the South African Bureau of Standards (1980).

The activities that are crucial in the design and execution of the construction are the accurate specifications and suitable measures for the total resistance-capacity increase of the masonry structural element (Juhásová et al., 2008). The poor performance of non-structural components, such as chimneys and balustrades, compromise the protection of occupiers in slightly damaged buildings mainly in historical centres, thus stressing the importance of detailed designs (Penna et al., 2014).

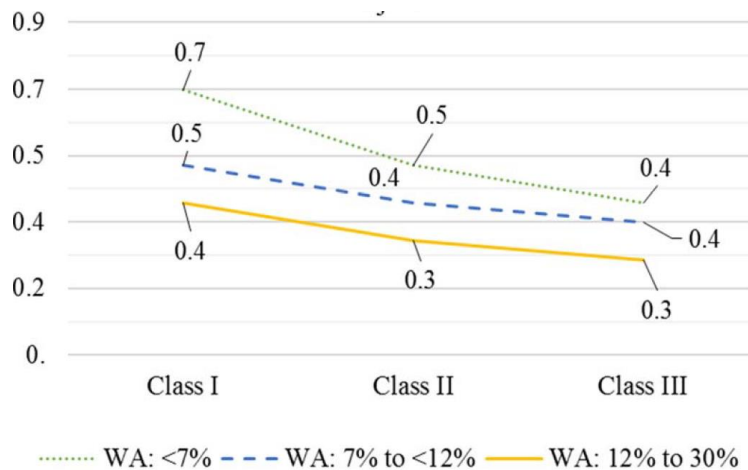

Figure 2. Characteristic flexural strength of clay units,  $f_{kx}$ , in MPa for plane of failure parallel to bed joint

Natural materials like clay do not always meet the technical demands (Maubec et al., 2017). There are distinct clay soils comprising distinct kinds of clay minerals (Ouhadi et al., 2006). The conduct of clay soils relies heavily on the type of clay minerals included (Hamidi and Marandi, 2018). Quantitative mineral assessment of clay soils is a key step in ensuring accurate soil recognition and behaviour (Ouhadi and Yong, 2003). This is rarely practised by local unskilled clay brick producers. This presents difficulties to come even close to complying with technical requirements of clay bricks and ensuring consistent performance. The deposits of clay are created over several decades and contain a combination of several minerals of distinct grain sizes (Muñoz Velasco et al., 2014). The mineralogy of the clay products also influences the characteristics of their water retention (Ajayi and Horn, 2016).

Although the production of unfired clay bricks is relatively simple, the type and quantity of additives used, the optimum water absorption to maximise the compaction effort and the achievable dry density, must be carefully determined in order to achieve maximum strength and durability (Miqueleiz et al., 2012). Consequently, the clay fraction and plasticity index are unreliable indicators of the susceptibility to liquefaction of cohesive soils without taking into account the clay mineralogy and its distinct adhesive bond strength on the boundary layers (Tosti et al., 2013). It is these characteristics that contribute to the legendary unreliability of clay bricks made using even properly tested mined clay in terms of technical criteria such as compressive strength and water absorption quality.

The literature reviewed indicates that the physical properties of clay bricks significantly affects the of design performance of brick walls subjected to bending. Water absorption is the focus of this study and it is directly related to the bond strength. It is, therefore, important to understand how each factor contributes to another in order to provide a good-quality structural system. Although the excessive mining of clay to make clay masonry has far-reaching consequences for the environment, a lesser case scenario is that of obtaining good-quality clay masonry walls rather than both defective masonry walls and a degraded environment.

## METHODOLOGY

The researcher identified two sites in Qwaqwa and Newcastle, South Africa, where clay bricks are manufactured by the community. From these sites, 11 samples of each unit type (low and high burnt units) were received from each location for a 12-month period. These samples were newly made clay bricks. There was a total of 264 bricks (11 units x 2 types, low and high burnt x 12 months) obtained from each site operated by developing entrepreneurs/ manufacturers. This yielded a total of 528 specimen tested from two (2) sites. The samples were tested for the water absorption quality. Conducting the test needed three (3) tools, as laid out in Clause 6.9 of the South African National Standard 227. These tools are: a forced-draught drying kiln capable of maintaining a temperature of at least 105 °C; a lidded heating tank with a grid at the bottom to allow circulation of water all around the units; and a balance able to measure the mass of units to an accuracy of 0.1%. In this process, elements are dried in a kiln at a minimum temperature of 105 °C until the achievement of a constant mass ( $m_1$ ). The samples are dipped in clean water for 24 hours in a constant room temperature of 24-25°C.

The samples are then removed from the water, wiped with a wet cloth, with the mass ( $m_2$ ) measured immediately. After 24 hours of the immersion test, the samples are put in a grid inside a tank. The samples are then subjected to a 5-hour test where the temperature of the water is increased to boiling point for over a one-hour period and preserved at boiling point for 5 hours. The samples are kept in the tank without draining the water and left for 16-19 hours to cool off naturally. After this period, the specimens are removed from the water, wiped with a wet cloth before the mass ( $m_3$ ) is measured. The water absorption capacity of the specimens is then calculated according to Clause 6.9.4 (South African National Standard, 2007), namely: a) Calculate the cold water absorption of each unit (24 h cold water absorption,  $\%(m/m) = (m_2 - m_1)/m_1 \times 100$ ) and then calculate the average of the units; b) Calculate the boiling water absorption of each unit (5 h boiling water absorption,  $\%(m/m) = (m_3 - m_1)/m_1 \times 100$ ) and then calculate the average of the units; c) Record the individual results to the nearest 0,01 % and the average result to the nearest 0,1 %; d) Calculate the saturation coefficient of each unit (saturation coefficient = 24 h cold water absorption,  $\%(m/m) / 5$  h boiling water absorption,  $\%(m/m)$ ) and record the individual results and the maximum result to the nearest 0,01 %. The two sites (Figure 3 and 4) were selected because they are open to the public to quarry clay and transform it to usable building material such as clay bricks and easy to drive to for purchasing clay bricks towards the end of each month.



Figure 3. (Left) Madadeni and Figure 4. (Right) Qwaqwa clay bricks manufacturers

Apparatuses used to conduct experiments are depicted in Figure 5, 6 and 7.

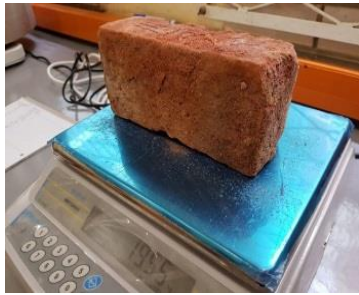

Figure 5. Scale used to measure the mass of clay bricks



Figure 6. Pot used to boil clay bricks



Figure 7. Oven used to dry clay bricks

A significance test, which is the act of comparing observable data to a claim (also known as a hypothesis) whose veracity is being assessed, was omitted from the research since it lacked a hypothesis and was purely exploratory in nature. Additionally, no experimental soil samples were taken because it was determined during the study's preparation that no samples, with consistent geological materials, would be obtained over a 12-month period because the area where the mine is quarried can vary significantly, even during a month of clay brick production. This means that the experimental soil samples will yield insignificant findings.

## FINDINGS AND DISCUSSION

Table 1 (Qwaqwa) and Table 2 (Madadeni) provide average moisture contents. The trial began in February 2017 and concluded in January 2018. Although water absorption rates over 30% are considerably too high, they were tested since the public continues to purchase those bricks.



**Table 1 Qwaqwa**

Brick Type	Month	Average mass (g)	Final Moisture (%) content of 11 clay bricks	Less than 7 %	7 % up to but not including 12 %	12 % to 30 %	More than 30%
Hard Burnt	February	2278	21.7	-	-	POOR	-
	March	2270	23.6	-	-	POOR	-
	April	2196	32.3	-	-	-	REJECT
	May	2107	38.4	-	-	-	REJECT
	June	2227	26.1	-	-	POOR	-
	July	2209	31.1	-	-	-	REJECT
	August	2175	29.0	-	-	POOR	-
	September	2236	30.0	-	-	-	REJECT
	October	2279	31.5	-	-	-	REJECT
	November	2198	36.0	-	-	-	REJECT
	December	2275	27.1	-	-	POOR	-
	January	2168	35.5	-	-	-	REJECT
Low Burnt	February	2421	22.8	-	-	POOR	-
	March	2467	20.6	-	-	POOR	-
	April	2467	16.3	-	-	POOR	-
	May	2375	24.8	-	-	POOR	-
	June	2203	35.0	-	-	-	REJECT
	July	2498	20.0	-	-	POOR	-
	August	2379	25.8	-	-	POOR	-
	September	2137	35.3	-	-	-	REJECT
	October	2495	16.0	-	-	POOR	-
	November	2387	24.7	-	-	POOR	-
	December	2267	32.1	-	-	-	REJECT
	January	2446	18.3	-	-	POOR	-

Various combinations relating to the water absorption and site, type of brick and month were analysed. Considering only the manufacturing site and the water absorption of brick purchased from them, they produced the following results: (1) Qwaqwa had 27.3% with a standard deviation of 6.6, which means that the data was more spread out; (2) Madadeni had 34.3% with a standard deviation of 9.6 which also means that the data was more spread out. There is a significant difference in the mean water absorption by site ( $p = 0.005$ ). It is no surprise because there are distinct clay soils that contain various types of clay minerals. The conduct of clay soils is highly dependent on the included type of clay minerals. Quantitative mineral evaluation of clay soils is a crucial step in ensuring correct identification and behavior of soils. The partial eta squared value ( $\eta^2 = 0.162$ ) also confirms that the site does play a significant role with respect to the water absorption ( $\eta^2 > 0.14$  implies a large effect).

Table 2 Madadeni

Brick Type	Month	Average mass (g)	Final Moisture (%) content of 11 clay bricks	Less than 7 %	7 % up to but not including 12 %	12 % to 30 %	More than 30%
Light Burnt	January	1972	28.3	-	-	POOR	-
	February	1980	33.0	-	-	-	REJECT
	March	2198	25.9	-	-	POOR	-
	April	2098	31.6	-	-	-	REJECT
	May	2154	24.4	-	-	POOR	-
	June	2008	44.7	-	-	-	REJECT
	July	2196	27.8	-	-	POOR	-
	August	2108	31.3	-	-	-	REJECT
	September	2106	29.8	-	-	POOR	-
	October	2179	33.4	-	-	-	REJECT
	November	1975	45.2	-	-	-	REJECT
	December	1869	54.5	-	-	-	REJECT
Hard Burnt	January	2078	22.6	-	-	POOR	-
	February	2065	26.7	-	-	POOR	-
	March	1997	33.6	-	-	-	REJECT
	April	2067	29.6	-	-	POOR	-
	May	1976	35.4	-	-	-	REJECT
	June	2069	27.5	-	-	POOR	-
	July	2097	24.0	-	-	POOR	-
	August	1976	46.6	-	-	-	REJECT
	September	1899	46.9	-	-	-	REJECT
	October	1908	55.8	-	-	-	REJECT
	November	2019	38.1	-	-	-	REJECT
	December	2067	27.6	-	-	POOR	-

This corresponds to the literature study about possible technical performance of clay units due to varying mineralogical characteristics. In view of the site only and with respect to the brick type, the investigation yielded the following means: (1) Qwaqwa had 32.2% with a standard deviation of 7.5 which means that the data is more spread out; (2) Madadeni had 29.4% with a standard deviation of 10.1, which means that the data is more spread out. Even though hard burnt has a slightly higher value than low burnt, the difference in the water absorption is not significant ( $p = 0.287$ ). This is also seen by the small effect  $\eta^2$  value (0.025). With respect to the site and the brick type, there is a significant relationship between the water absorption and a combination of site and brick type ( $p = 0.005$ ). The  $\eta^2$  value (0.039) indicates a small to medium effect. The month (which signifies the date of mining) indicated a large effect ( $\eta^2 = 0.213$ ) on the level of moisture. As seen



previously, the site and the month played a role in terms of the water absorption. In addition, the combination of site and month was also a large contributor to the water absorption. Since moisture absorption between hard and slight burnt brick is insignificant, the results per site per month were combined as indicated in Figure 8.

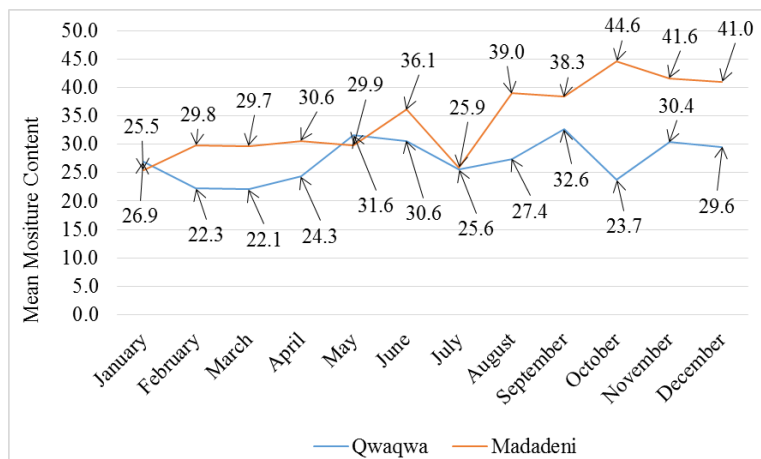

Figure 8. Average water absorption for a period of 12 months

Results prove that natural materials, such as clay, do not always correspond to technical demands (Maubec et al., 2017) in addition to the majority of manufacturers who do not possess the required knowledge and skills, which has resulted in the production of poor-quality clay units. Clay soils which consist of distinct kinds of clay minerals (Ouhadi et al., 2006) provide difficulties as the conduct of clay soils relies heavily on the type of clay minerals included (Hamidi and Marandi, 2018) which further affects the manufacturing process. Quantitative mineral assessment of clay soils is a key step in ensuring accurate soil recognition and behaviour (Ouhadi and Yong, 2003) and this is lacking in most clay bricks manufacturing processes. Necessary continuous testing of construction materials is rarely undertaken if not at all. This presents difficulties in coming even close to complying with technical requirements of clay bricks and ensuring consistent performance. The results highlight a need for continuous testing of all materials used in the manufacturing process to inform the public of the characteristics/limitations, including those presented by clay bricks they use to construct masonry walling.

## CONCLUSION AND RECOMMENDATION

For the investigated sites, specifying clay units with less than 12% water absorption may compromise the level of intended flexure performance, as clay bricks that offer such performance do not exist. This is an issue because more ideal/satisfactory characteristic flexural strength of masonry made with clay units,  $f_{kx}$ , in MPa for plane of failure equivalent to bed joint will be assumed. Even though hard burnt has a slightly higher value than low burnt, the difference in the water absorption is not significant ( $p = 0.287$ ). This is also seen by the small effect  $\eta^2$  value (0.025). With respect to the site and the brick type, there is a significant relationship between the water absorption and a combination of site and brick type ( $p = 0.005$ ). The  $\eta^2$  value (0.039) indicates a small to medium effect. The unavailability of such clay bricks from the merchants (12% to 20%) makes this almost impossible to

achieve in real masonry walling. Independent confirmation concerning the water absorption of clay units intended to be used in construction is absolutely necessary for designers of masonry walling. The South African Bureau of Standards (SABS) must promote and maintain standardization, quality and service provision related to the manufacturing of construction materials such as clay bricks. This study is the first to explore the water absorption quality of clay bricks made by emerging manufacturers in South Africa.

## REFERENCES

- Ajayi, A. E., & Horn, R. (2016). Comparing the potentials of clay and biochar in improving water retention and mechanical resilience of sandy soil. *International Agrophysics*, 30, 391-399.
- Al-Sanea, S. A., Zedan, M. F., & Al-Hussain, S. N. (2013). Effect of masonry material and surface absorptivity on critical thermal mass in insulated building walls. *Applied Energy*, 102, 1063-1070.
- Al-Sibahy, A., & Edwards, R. (2017). Characterization of the clay masonry units and construction technique at the ancient city of Nippur. *Engineering Structures*, 147, 517-529.
- Bidoung, J. C., Pliya, P., Meukam, P., Noumowé, A., & Beda, T. (2016). Behaviour of clay bricks from small-scale production units after high temperature exposure. *Materials and Structures*, 49, 4991.
- Bosiljkov, V., Page, A. W., Bokan-Bosiljkov, V., & Zarnic, R. (2010). Review Paper, Progress in Structural Engineering and Material: Structural Masonry. *STRUCTURAL CONTROL & HEALTH MONITORING*, 17, 100-118.
- Crofts, F., & Lane, J. (2011). *Structural Masonry Design*, Midrand, South Africa, Concrete Manufacturers Association,.
- Cultrone, G., & Sebastián, E. (2009). Fly ash addition in clayey materials to improve the quality of solid bricks. *Construction and Building Materials*, 23, 1178-1184.
- Day, P. (2011). SAICE's interaction with the South African Bureau of Standards. *Civil Engineering: Magazine of the South African Institution of Civil Engineering*. Yeoville: The South African Institution of Civil Engineers.
- Hamidi, S., & Marandi, S. M. (2018). Clay concrete and effect of clay minerals types on stabilized soft clay soils by epoxy resin. *Applied Clay Science*, 151, 92-101.
- Juhásová, E., Sofronie, R., & Bairrão, R. (2008). Stone masonry in historical buildings — Ways to increase their resistance and durability. *Engineering Structures*, 30, 2194-2205.
- Li, Z., Chen, W., Chen, L., Fang, Q., Hao, H., Zhang, Y., Xiang, H., Yang, S., & Bao, Q. (2017). Experimental and numerical study of unreinforced clay brick masonry walls subjected to vented gas explosions. *International Journal of Impact Engineering*, 104, 107-126.
- Luso, E., & Lourenço, P. B. (2017). Bond strength characterization of commercially available grouts for masonry. *Construction and Building Materials*, 144, 317-326.
- Maheri, M. R., Motielahi, F., & Najafgholipour, M. A. (2011). The effects of pre and post construction moisture condition on the in-plane and out-of-plane strengths of brick walls. *Materials and Structures*, 44, 541-559.

- Marglin, S. A. (2017). Wages, prices, and employment in a Keynesian long run. *Review of Keynesian Economics*, 5, 360-425.
- Maubec, N., Deneele, D., & Ouvrard, G. (2017). Influence of the clay type on the strength evolution of lime treated material. *Applied Clay Science*, 137, 107-114.
- Miqueleiz, L., Ramírez, F., Seco, A., Nidzam, R. M., Kinuthia, J. M., Tair, A. A. & Garcia, R. (2012). The use of stabilised Spanish clay soil for sustainable construction materials. *Engineering Geology*, 133-134, 9-15.
- Molnár, M. & Larsson Ivanov, O. (2016). Clay brick masonry facades with cracks caused by corroding bed joint reinforcement – Findings from field survey and laboratory study. *Construction and Building Materials*, 125, 775-783.
- Monteiro, S. N., & Vieira, C. M. F. (2014). On the production of fired clay bricks from waste materials: A critical update. *Construction and Building Materials*, 68, 599-610.
- Muñoz Velasco, L., Muñoz Velasco, P., Morales Ortíz, M. P., & MENDÍVIL GIRÓ, M. A. (2014). Fired clay bricks manufactured by adding wastes as sustainable construction material – A review. *Construction and Building Materials*, 63, 97-107.
- Noor-E-Khuda, S., & Albermani, F. (2019). Mechanical properties of clay masonry units: Destructive and ultrasonic testing. *Construction and Building Materials*, 219, 111-120.
- Nordby, A. S., & Shea, A. D. (2013). Building Materials in the Operational Phase. *Journal of Industrial Ecology*, 17, 763-776.
- Ouhadi, V. R., & Yong, R. N. (2003). Impact of clay microstructure and mass absorption coefficient on the quantitative mineral identification by XRD analysis. *Applied Clay Science*, 23, 141-148.
- Ouhadi, V. R., Yong, R. N., & Sedighi, M. (2006). Influence of heavy metal contaminants at variable pH regimes on rheological behaviour of bentonite. *Applied Clay Science*, 32, 217-231.
- Pacheco-Torgal, F. & Jalali, S. (2012). Earth construction: Lessons from the past for future eco-efficient construction. *Construction and Building Materials*, 29, 512-519.
- Penna, A., Morandi, P., Rota, M., Manzini, C. F., Da Porto, F. & Magenes, G. (2014). Performance of masonry buildings during the Emilia 2012 earthquake. *Bulletin of Earthquake Engineering*, 12, 2255-2273.
- Rao, K. V. M., Reddy, B. V. V., & Jagadish, K. D. (1996). Flexural bond strength of masonry using various blocks and mortars. *Materials and Structures*, 29, 119-124.
- Rashid, K., Haq, E. U., Kamran, M. S., Munir, N., Shahid, A., & Hanif, I. (2019). Experimental and finite element analysis on thermal conductivity of burnt clay bricks reinforced with fibers. *Construction and Building Materials*, 221, 190-199.
- Santhosh, V., Padmalal, D., Baijulal, B., & Maya, K. (2013). Brick and tile clay mining from the paddy lands of Central Kerala (southwest coast of India) and emerging environmental issues. *Environmental Earth Sciences*, 68, 2111-2121.
- Slevin, R., & Whalen, E. (1998). Turning a lump of clay into a brick. 148. Available: <http://dut.summon.serialssolutions.com/>.
- South African Bureau Of Standards (1980). The structural use of masonry Part 1: Unreinforced masonry walling. SABS 0164. Pretoria: The South African Bureau of Standards.
- South African National Standard (2007). Burnt clay masonry units. SANS 227. Pretoria: Standards South Africa.

- The Clay Brick Association Of Southern Africa. (2021). The voice of the clay brick industry [Online]. Building 2, Unit 6, Ground Floor, Bedfordview Office Park, 3 Riley Road, Bedfordview 2007: The Clay Brick Association of Southern Africa. Available: <https://www.claybrick.org/> [Accessed 12 June 2021 2021].
- Tosti, F., Patriarca, C., Slob, E., Benedetto, A. & Lambot, S. (2013). Clay content evaluation in soils through GPR signal processing. *Journal of Applied Geophysics*, 97, 69-80.
- Wu, F., Li, G., Li, H.-N. & Jia, J.-Q. (2013). Strength and stress-strain characteristics of traditional adobe block and masonry. *Materials and Structures*, 46, 1449.
- Yang, Y., Yu, S. Y., Zhu, Y. & Shao, J. (2014). The Making of Fired Clay Bricks in China Some 5000 Years Ago. *Archaeometry*, 56, 220-227.
- Zhang, L. 2013. Production of bricks from waste materials – A review. *Construction and Building Materials*, 47, 643-655.
- Zhang, Z., Wong, Y. C., Arulrajah, A. & Horpibulsuk, S. (2018). A review of studies on bricks using alternative materials and approaches. *Construction and Building Materials*, 188, 1101-1118.
- Zohreh Heydariha, J., Das, S., & Banting, B. (2017). Effect of grout strength and block size on the performance of masonry beam. *Construction and Building Materials*, 157, 685-69

## INDEX OF AUTHORS

### A

Abba, M., 379  
Abdulazeez, S. R., 177  
Abdullah, A., 1023  
Abdulmalik, B., 21  
Abdulmumin, A., 333  
Abdulrahman, R. S., 823  
Abdulrazaq, M., 779  
Aborah-Osei, C., 629  
Abubakar, M., 81, 207, 685  
Abubakar, M., 1001  
Acquah, J. H., 457  
Adamu, A., 207  
Adamu, A. D., 177  
Addy, M. N., 363  
Adedayo, A. G., 671  
Adedeji, J. A., 311  
Adedokun A. R., 431  
Adegbie, M. O., 739  
Adegun, O. B., 739  
Adeleke, B. K., 515  
Adeyemi, T. E., 1045  
Adinyira, E., 805  
Adogbo, A. K., 1013  
Agbabiaka, H. I., 1045  
Agyekum, K., 805  
Ahmadu, H. A., 823  
Aidoo, I., 805  
Aiyepada, E. G., 909  
Ajenifujah-Abubakar, A. O., 43  
Aju, D. E., 763  
Akinlolu, M., 973  
Akinremi, A. R., 671  
Akinsanya, A. Y., 557  
Alaneme, G. U., 163  
Alfa, N. M., 515  
Ali, Z. A., 259  
Aluko-Olokun B. A., 779  
Amanamba, E. C., 925  
Angulu, H., 379  
Ansah, N. B., 805  
Antwi-Afari, M. F., 277  
Anwer, S., 277  
Appau, W. M., 875  
Arowolo, L. A., 177  
Assiamah, S., 569  
Asumadu, R. S., 99  
Atoyebi, A. K., 469  
Attakora-Amiampong, E., 875  
Auwalu, F. K., 749  
Ayeni, D. A., 43  
Ayodele, T. O., 645

### B

Bala K., 21  
Bala, K., 391  
Bala, K., 945

Bamfo-Agyei, E., 457

Bobadoye, S. A., 43

### C

Chan, A. P. C., 579, 895  
Charles-Afolabi, Y. C., 701  
Chindo, P. G., 333  
Chipungu, L., 137  
Chiwuzie, A., 793, 909  
Ciroma, F. B., 287

### D

Dabara, D. I., 909  
Dahiru, D. D., 543  
Danso, H., 99, 115  
Danso, H., 457  
Danso, H., 569  
Danso, H., 629  
Danso, H., 715  
Darko, A., 725  
Derbile, E. K., 875  
Dipeolu, A. A., 311, 957  
Dodo, M., 21  
Dok-Yen, D. M., 363  
Dowelani, F., 351  
Duah, D. Y. A., 363  
Durosinmi, W. A., 701

### E

Ejeh, D. E., 59  
Ekweani, C. P., 1013  
Elimisiemon, Monday Chris, 933  
Eludoyin, O. M., 501  
Emma-Ochu, C. A., 597  
Eshun, B. T. B., 579  
Eze, B. D., 33

### F

Fadairo, G., 311  
Fadamiro, J. A., 311  
Fajana, S., 33  
Fateye, T. B., 431  
Fugar, F. D. K., 579

### G

Gabriel-Wettey, F. K. N., 715  
Galadima, M., 379  
Gambo, M. M., 21  
Gambo, M. M., 529  
Gambo, S., 195  
Gambo, S., 529  
Gangas, P. C., 779  
Garba, M. M., 543  
Ghali, A. A., 749  
Groenewald, B., 645

### H

Haupt, T. C., 973

### I

Ibem, E. O., 311  
Ibrahim, A. D., 391

Ibrahim, A. D., 823  
 Ibrahim, A. D., 945  
 Ibrahim, A. G., 219  
 Ibrahim, A. G., 529  
 Ibrahim, A. M., 81  
 Ibrahim, A. M., 391  
 Ibrahim, Y. M., 1001  
 Ibuoye, A. A., 431  
 Idiako J. E., 259  
 Ifeanyichukwu, N. E., 609  
 Ikemefuna, M., 609  
 Iliyasu, I. I., 1023  
 Isah, I., 685  
 Ishaq, Z. H., 81  
 Ishaq, Z. I., 685  
**J**  
 Jiboye, A. D., 1045  
 Jiya, V. H., 945  
 Jolaoso, B. A., 483  
**K**  
 Kado, D., 945  
 Kajimo-Shakantu, K., 645  
 Keke, E. O., 163  
 Khuzwayo, B. P., 1063  
 Kolo, B. A., 333, 779  
 Kolo, B. A., 823  
 Kolo, B. A., 1013  
 Kuforiji, A. A., 33  
**L**  
 Lawal, Y. S., 81, 685  
 Li, H., 277  
**M**  
 Magidimisha-Chipungu, H., 137  
 Maina, J. J., 59, 287  
 Mamman, M., 701  
 Marzbali, M. H., 1023  
 Mbamali, I., 597  
 Medayese, S., 137  
 Medayese, S. O., 661  
 Mkasi, P., 419  
 Mohammed, A., 1013  
 Mohammed, M., 661  
 Mohammed, Y. D., 259  
 Morakinyo, T. E., 739  
 Muhammad, J. A., 259  
 Muhammad, S., 685  
 Muhammed, B., 749  
 Musa-Haddary, Y. G., 333  
**N**  
 Nnaemeka-Okeke, R. C., 843  
 Nwaogu, J. M., 895  
**O**  
 Odesanmi, A., 379  
 Odunfa, V. O., 431  
 Oduwole, A., 987  
 Ofori, G., 405  
 Ogbeifun, E., 419  
 Ogungbemi, D. A., 299  
 Ohadugha, C. B., 661  
 Ojo, O. M., 671  
 Ojo, S. O., 469  
 Oke, O. E., 1045  
 Okeke, F. O., 843  
 Okoli, O. G., 543  
 Okolie, K. C., 597  
 Olanipekun, A. O., 299  
 Olanipekun, A. O., 857  
 Olanrele, O. O., 483  
 Olanrewaju S. D., 43  
 Olatunji, S. A., 235  
 Olawuyi, S. T., 909  
 Olorunlana, F. A., 249  
 Oloruntoba, S. M., 857  
 Olowoporoku, O. A., 235  
 Olowu, O. A., 557  
 Oluigbo, S. N., 59  
 Olusoga, O. O., 739  
 Onamade, A. O., 311, 957  
 Onyelowe, K. C., 163, 763  
 Onyelowe, K. C., 925  
 Opara, V. I., 557  
 Oyeleke, F. M., 195  
 Ozumba, A. O. U., 351  
**P**  
 Park, K. S., 277  
 Poopola, J. O., 933  
 Popoola, A., 137  
 Pretorius, J. H. C., 419  
 Prince, E. M., 909  
**R**  
 Raheem, A. A., 557  
 Rahim, A. A., 449  
**S**  
 Sa'ad, M. M., 195  
 Saad, M. M., 219  
 Sackey, K. A. N., 543  
 Sagada, M. L., 59, 287  
 Saheed, J., 671  
 Salihu, A. A., 195  
 Salisu, A. S., 933  
 Samad, N. A. A., 449  
 Samaila, H., 379  
 Santali, B. N., 661  
 Sanusi, Y. A., 661  
 Seman, W. M. W., 449  
 Seo, J., 277  
 Shakantu, W., 609  
 Shika, A. S., 219  
 Shittu, A. A., 177, 259  
 Sodiya, A. K., 431  
 Sufiyan, M. B., 59  
 Sulyman, A. O., 661  
**T**  
 Tetteh, M. O., 725  
 Tolani, S. A., 609  
 Torku, A., 277  
 Tsado, A. J., 177

U

Udeala, R. C., 163  
Uranta, J. D. C., 163  
Usman, J., 195  
Usman, J., 529

W

Wahab, M. B., 701  
Wirekoh, F. K., 115  
Wu, Y., 749

Y

Yahya, A., 529  
Yevu, S. K., 725  
Yu, A. T. W., 725  
Yussuf, S. O., 671  
Yussuf, S. O., 1045

Z

Zailani, B. M., 207  
Zailani, B. M., 1001  
Zakari, D. U., 701  
Zubairu, I. K., 391

# INDEX OF KEYWORDS

## A

absorption, 529  
academic performance, 793  
acceptance, 287  
access design solution, 449  
accessibility, 449  
adaptive neuro fuzzy inference system (ANFIS), 163  
affordability, 671  
affordable housing, 363  
Africa, 137  
aggregates, 529  
architects, 933  
architectural education, 43  
assessment, 219, 685  
attitude, 1001  
awareness, 207, 287, 311

## B

behaviour, 609, 1001  
benchmark, 609  
BIM, 351, 933  
BIM education, 333, 933  
BIM tools, 933  
BIM usage architects, 933  
binomial method, 81  
body of knowledge, 405  
building construction industry, 629  
building design, 1045  
building information modelling (BIM), 115  
building investment, 81  
building materials, 195  
building projects, 945  
buildings, 351  
built environment, 1023  
built environment professionals, 21

## C

CA Markov, 749  
CAD, 43  
capacity and capability, 405  
carbon monoxide, 661  
career, 973  
causes, 249  
cereal flours, 515  
challenges, 432, 857  
Clanwilliam dam, 419  
clay bricks, 1063  
clayey soil, 925  
collaboration, 33  
commercial properties, 701  
commercial real estate, 875  
communication patterns, 59  
compliance, 99  
compressed stabilised earth brick, 543  
compressive strength, 515, 569, 715  
conceptual model, 333

concrete, 515, 529, 715  
conservation, 311  
constrained simplex method, 763  
construction, 597, 1013  
construction firms, 177, 259  
construction in developing countries, 405  
construction industry, 207, 725, 843, 1001  
construction performance, 115  
construction personnel, 895  
construction procurement, 725  
construction project delivery, 299  
construction projects, 597, 685  
construction sites, 195, 457, 857  
construction SMEs, 259  
construction workers, 277  
contractors' pre-qualification, 419  
conventional and contemporary valuation methods, 909  
coping strategies, 895  
cost performance, 945  
covid-19, 432  
COVID-19, 957  
COVID-19 pandemic, 33  
co-working, 432  
crime pattern, 1023  
curing method, 715  
curriculum, 43

## D

data integration, 391  
data sharing, 391  
data transformation, 391  
delivery, 235  
design expert, 763  
design for safety (Dfs), 207  
development models, 483  
District Assemblies Common Fund (DACF), 629  
domestic energy, 661  
durability, 529

## E

ecosystems, 957  
Ede, 793  
e-HR, 33  
electronic procurement, 725  
emotional intelligence (EI), 33  
energy consumption, 609  
energy poverty, 661  
energy sector, 779  
engineering procurement and construction (EPC), 779  
ENVI-met, 739  
environmental criminology, 1023  
environmental risks, 299  
environmental sustainability, 311, 957  
expansion option, 81



extreme vertices, 763  
 F  
 facilities, 351  
 facilities management services, 219  
 fire outbreak, 99  
 flexural strength, 557, 715, 1063  
 floods, 249  
 framework, 469  
 frugal innovation, 363  
 G  
 generational gap, 895  
 generator, 661  
 Geographic Information Systems(GIS), 749  
 geogrid, 763  
 geopolymer cement, 925  
 Ghana, 115  
 global south, 805  
 governance, 469  
 graduating students, 793  
 green infrastructure, 739, 957  
 green infrastructure (GI), 311  
 H  
 hazard recognition, 1001  
 health, 432, 597  
 health and safety, 597  
 health and safety measures, 177  
 hedging capacity, 701  
 higher education, 333  
 homeowners, 645  
 hospitals, 219  
 hotel investment, 875  
 housing, 671, 1045  
 housing supply, 483  
 hybrid binder, 163  
 I  
 ICT, 351  
 impact, 685, 945  
 impacts, 249  
 implementation, 779  
 inclusive development, 449  
 income, 671  
 indoor characteristics, 501  
 inflation, 701  
 information and communication  
     technology, 177  
 infrastructure, 235, 469  
 infrastructure services, 875  
 inspection delay, 457  
 interlocking blocks, 569  
 interpersonal skills, 21  
 Interpretive Structural Modelling (ISM), 579  
 intervention, 483  
 K  
 knowledge, 287  
 L  
 labour output, 457  
 labour productivity, 457  
 land use/land cover change, 749  
 large projects, 823  
 laterite, 543, 569  
 learning and teaching, 909  
 liveable communities, 137  
 LULC prediction, 749  
 M  
 management, 351  
 masonry walling, 1063  
 mass housing programme, 21  
 material sustainability, 805  
 maximum aggregate size, 557  
 mental health, 957  
 Metropolitan Municipal and District  
     Assemblies (MMDA's), 629  
 Monte Carlo simulation, 81  
 motivation, 857  
 Mutual Satisfaction (MS), 579  
 N  
 needs, 857  
 Nigeria, 207, 235, 469, 779  
 Nigerian economic sustainability plan, 21  
 non-industrialised economy, 333  
 O  
 occupiers, 671  
 ontology, 333  
 organisational culture, 59  
 outsourcing, 219  
 P  
 palm kernel shell (PKS), 529  
 pavement subgrade, 925  
 payment delay, 457  
 perceived usefulness, 287  
 perception, 235, 501  
 performance, 219  
 performance-based contracting (PBC), 779  
 petroleum, 543  
 physical fatigue, 277  
 physiology, 501  
 place-making, 137  
 plaster of Paris (POP), 195  
 PLS-SEM, 987  
 policy, 483  
 polytechnic, 909  
 Portland cement, 379  
 pozzolans, 543  
 practice, 987  
 procurement process, 419  
 professional valuers, 645  
 professionals, 207  
 project, 195  
 project contributory factors, 945  
 project delivery, 629  
 property value determinants, 645  
 public building, 99  
 public infrastructure, 579  
 public private partnership, 469  
 Q  
 quality, 685, 1045  
 quality of life, 137  
 quarry dust, 925

R  
 real estate, 793  
 real estate agents, 645  
 real estate investment, 909  
 reduction measure, 609  
 remedial and management strategies, 249  
 remotely sensed data, 749  
 rent, 671  
 rental price, 701  
 repetitive lifting task, 277  
 research new perspectives, 405  
 residential building, 609  
 residential outdoor space, 1045  
 residential property, 645  
 responsible material, 805  
 responsible sourcing, 805  
 retarding admixture, 515  
 risk factors, 685  
 risk interdependences, 823  
 risk management, 823  
 risk systemicity, 823  
 riss aggregate, 557  
 S  
 safety, 597, 1001  
 safety compliance, 597  
 safety measures, 259  
 safety performance, 99  
 selection of quality contractor, 419  
 self-efficacy, 973  
 setting time, 515  
 setting time test, 379  
 shared office, 432  
 Sino-Ghana, 579  
 slump tests, 715  
 small city, 875  
 smart contract, 1013  
 smart security system, 287  
 smartPLS, 987  
 social housing, 483  
 social interactions, 59  
 social procurement, 843  
 social sustainability, 843  
 socially disadvantaged groups, 843  
 soft computing, 163  
 soil, 763  
 soil stabilization, 163  
 sorptivity, 529  
 soundness test, 379  
 South Africa, 973  
 space syntax, 59  
 spatial accessibility, 875  
 spatial layout, 59  
 steel slag, 557  
 stress, 895  
 suction, 925  
 supervised machine learning classifiers, 277  
 surveying, 987  
 sustainability, 363  
 sustainable building development, 81  
 sustainable development, 1045  
 sustainable procurement, 725  
 T  
 technologically-enabled environment, 1013  
 technology acceptance model, 987  
 temperature, 501  
 tensile strength, 569  
 thermal comfort, 739  
 thermal stress, 501  
 total inclusiveness, 843  
 transnational, 579  
 U  
 unconfined compressive strength, 763  
 unconfined compressive strength (UCS), 163  
 universal design, 449  
 university, 909  
 university students, 973  
 unskilled women workers, 857  
 urban centre, 311  
 urban design, 739  
 urban liveability, 137  
 urban morphology, 1023  
 urban planning, 235  
 W  
 wastage, 195  
 water absorption quality, 1063  
 water infrastructure delivery, 419  
 wearable insole pressure system, 277  
 whole life cost data, 391  
 whole life cost models, 391  
 workplace, 33, 895  
 work-related musculoskeletal disorders, 277  
 X  
 x-ray fluorescence, 557



**9-11 AUGUST 2021**

Labadi Beach Hotel  
Accra, Ghana and Online

**TIME**

08:45am to 16:00pm GMT/UTC

**Please note your local time zone  
may be different**



**zoom**

**Click on icon to attend online**

Meeting ID: 894 6050 4735

Passcode: 661844

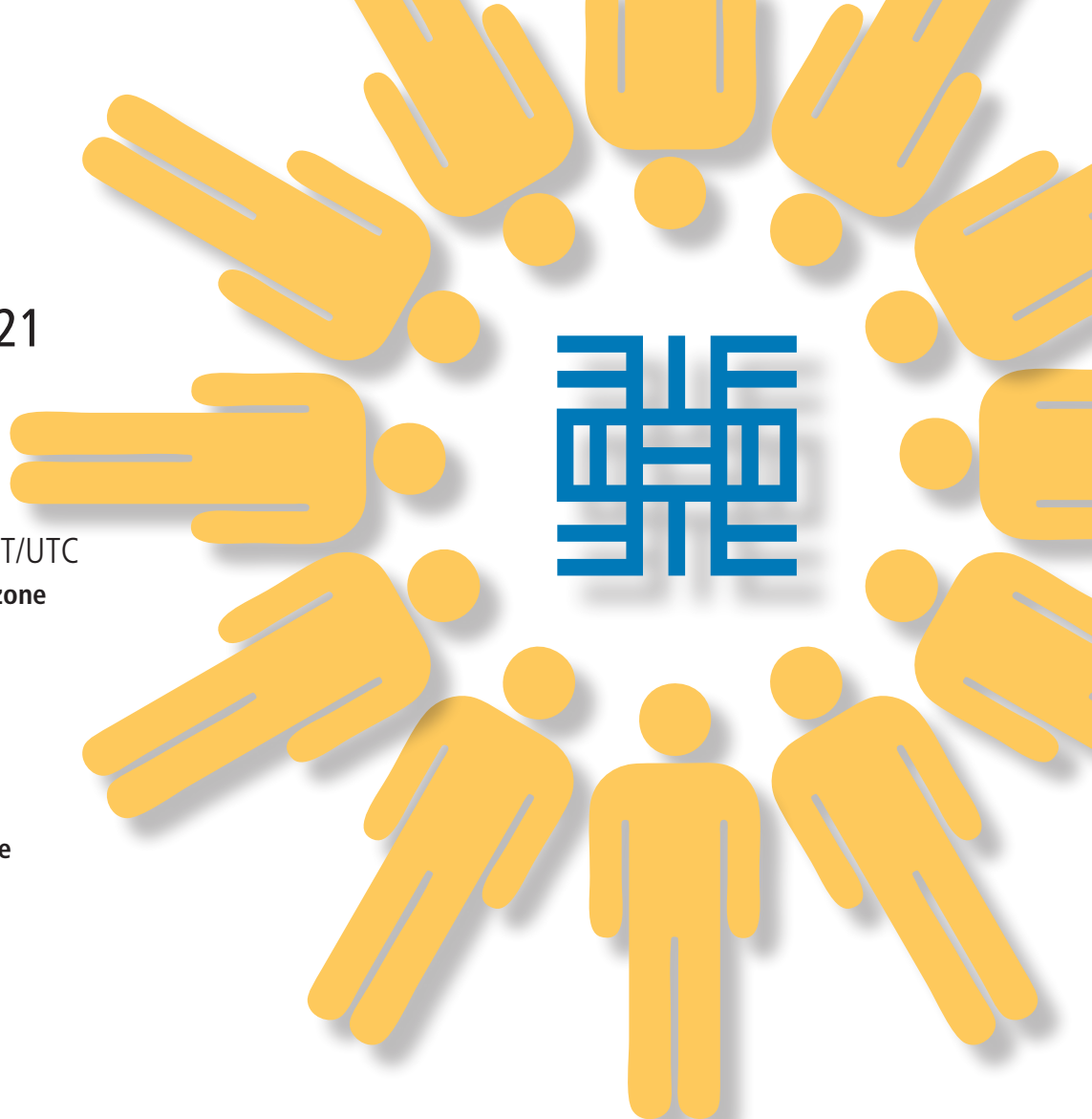

# WABER 2021 CONFERENCE

WEST AFRICA BUILT ENVIRONMENT RESEARCH CONFERENCE

WWW.WABERCONFERENCE.COM

KNOWLEDGE, INTERACTION, PEOPLE and LEADERSHIP

 [info@waberconference.com](mailto:info@waberconference.com)

 [www.waberconference.com](http://www.waberconference.com)

 @WABERConference

 West Africa Built Environment Research Conference

 For more information, please email  
us at [info@waberconference.com](mailto:info@waberconference.com)  
or Call/SMS/WhatsApp us on  
+233 545 204 300