



Development of *N,N'*-diacetylchitobiose as Coating Containing Antimicrobial Agent for Ready-to-eat Food Product

A thesis submitted to the University of Reading in fulfilment of the Degree
of Doctor of Philosophy

Department of Food and Nutritional Sciences

By

Munira Binti Zainal Abidin

December 2019

Author's Declaration

'Declaration: I confirm that this is my own work and the use of all material from other sources has been properly and fully acknowledged.'

Munira Binti Zainal Abidin

ACKNOWLEDGEMENTS

First and foremost, I would like to express my deepest appreciation to my academic supervisor, Prof. Keshavan Niranjana, for his guidance, constant supervision as well as for providing necessary information regarding this research and support in completing this endeavour.

I would like to express my special gratitude and thanks to Dr. Maria Paula Junqueira-Gonçalves, Prof. Vitaliy Khutoryanskiy, Dr. Konstantina Kourmentza and Dr. Andreas Kimon Karatzas for imparting their knowledge and expertise in this study. My deepest appreciation also goes to all technical staffs in Harry Nursten Building and Chemical Analysis Facilities (CAF) for their assistance and technical support throughout my study. Special thanks to my friends who are always being helpful and supportive through the difficult times.

I am highly indebted to Ministry of Education (MOE), Malaysia and Universiti Tun Hussein Onn Malaysia (UTHM) for providing financial support.

Last but not least, I would like to acknowledge with gratitude, the support and love of my family – my husband, Mohd Razak Zakaria; my daughter, Raisha Mohd Razak; and my son, Raef Mohd Razak. Thank you for always listening to me, supporting me and encouraging me.

Abstract

N,N'-diacetylchitobiose (GlcNAc₂) is known to be highly functional, soluble in water and offers a wide range of applications, especially as an antimicrobial agent. In this study, we aim to explore the use of thermal pre-treatment on chitin, prior hydrolysis to produce GlcNAc₂. The compound has been assessed for its antimicrobial activity against food pathogenic strains, as well as its effectiveness as an antimicrobial coating on ready-to-eat (RTE) cooked shrimp.

A thermal pre-treatment process using an autoclave, has been employed to facilitate subsequent enzymatic hydrolysis of chitin with chitinase from *Streptomyces griseus*. Pre-treatment of chitin with 0.05 M sodium acetate buffer (pH=6.0) at 121 °C for 60 min, followed by enzymatic hydrolysis involving 24 h incubation, were found to be the best conditions for producing GlcNAc₂. The GlcNAc₂ obtained was tested for its antimicrobial activity against Gram-negative and Gram-positive strains and showed minimum inhibitory concentrations (MIC) at 5 and 10% w/v against *Escherichia coli* K-12 and *Listeria monocytogenes* 10403S, respectively. The inhibitory effect of 1% (w/v) GlcNAc₂ used as antimicrobial coating on RTE cooked shrimp was studied at 4 °C for 16 days. In addition, the quality of the shrimp meat was also determined. The results indicated that the GlcNAc₂ coating retarded the changes in texture properties, TBARS values and moisture content of the RTE shrimp during storage. The incorporation of GlcNAc₂ coating did not significantly change the shrimp colour in comparison with the control. However, the growth of *L. monocytogenes* inoculated on the GlcNAc₂-coated RTE shrimp was slower than control sample, and the highest log reduction observed was 0.5 log CFU/mL. This study shows that autoclaving of chitin facilitates subsequent enzymatic hydrolysis to form a mixture dominating in GlcNAc₂, which possesses antimicrobial

activity that is able to inhibit food pathogenic strains and maintain the quality of ready-to-eat shrimp during refrigerated storage.

Table of Content

| | |
|--|-----------|
| Abstract | 3 |
| Chapter 1 : Introduction | 10 |
| 1. Introduction | 10 |
| 2. Objectives | 12 |
| Chapter 2 : Literature Reviews | 16 |
| 1. Introduction | 16 |
| 2. Preparation of chitin oligomers | 20 |
| 2.1 Methods based on acidic hydrolysis..... | 20 |
| 2.2 Methods based on enzymatic hydrolysis | 24 |
| 2.3 Use of chemical and physical adjunct treatments to intensify chitin hydrolysis | 27 |
| 3. Characteristics and characterization of chitin and its oligomers | 31 |
| 3.1 Chemical structure and composition | 32 |
| 3.2 Degree of <i>N</i> -acetylation | 35 |
| 3.3 Degree of polymerization | 36 |
| 3.4 Crystallinity..... | 39 |
| 3.5 Molecular weight..... | 40 |
| 3.6 Oligomers yield | 41 |
| 4. Antimicrobial properties of chitin derivatives and their oligomers..... | 43 |
| Chapter 3 : Enzymatic hydrolysis of thermally pre-treated chitin and antimicrobial activity of <i>N,N'</i>-diacetylchitobiose | 54 |
| 1. Introduction | 54 |
| 2. Materials and methods | 56 |
| 2.1 Pre-treatment of chitin | 56 |
| 2.2 Characterization of chitin..... | 57 |
| 2.3 Enzymatic hydrolysis of pre-treated chitin | 59 |
| 2.4 GlcNAc ₂ composition..... | 59 |
| 2.5 Antimicrobial activity determination | 60 |
| 2.6 Statistical analysis | 61 |
| 3. Results and discussions | 62 |
| 3.1 Effect of thermal pre-treatment on chitin | 62 |
| 3.2 Enzymatic hydrolysis of chitin..... | 66 |

| | |
|--|-----------|
| 3.3 Effect of GlcNAc ₂ on antimicrobial properties..... | 69 |
| 4. Conclusion..... | 72 |
| Chapter 4 : The effectiveness of <i>N,N'</i>-diacetylchitobiose (GlcNAc₂) as antimicrobial coating against <i>Listeria monocytogenes</i> on ready-to-eat shrimp..... | 76 |
| 1. Introduction | 77 |
| 2. Materials and methods | 78 |
| 2.1 Ready-to-eat (RTE) shrimp preparation | 79 |
| 2.2 Inoculum and inoculation | 79 |
| 2.3 Coating with GlcNAc ₂ | 80 |
| 2.4 Physicochemical analysis | 81 |
| 2.5 Microbial analysis | 82 |
| 2.6 Statistical analysis | 83 |
| 3. Results and discussions | 83 |
| 3.1 Effect of GlcNAc ₂ coating on the physicochemical properties of RTE shrimp | 83 |
| 3.2 Effect of GlcNAc ₂ coating on the RTE shrimp inoculated by <i>L. monocytogenes</i> | 89 |
| 4. Conclusion..... | 91 |
| Chapter 5 : Concluding remarks and recommendations for future work | 95 |
| 1. Key conclusions..... | 95 |
| 2. Recommendations for future work | 97 |
| Appendices..... | 98 |

List of Figures

| | |
|---|----|
| Figure 2-1. Chemical structures of: (a) Chitin and (b) Cellulose | 17 |
| Figure 2-2. Process flowsheet for acid hydrolysis of chitin with or without adjunct treatment. A and B represent different method for recovering chitin oligomers from the reaction mixture. ^{27,30,32,40-42,44,45} | 22 |
| Figure 2-3. Possible mechanism of chitin hydrolysis in concentrated HCl. Reprinted with permission from Kazami et al. ⁴⁵ Copyright 2015 Elsevier..... | 24 |
| Figure 2-4. Flow diagram for the enzymatic hydrolysis on chitin with or without adjunct treatment. A and B represent treatment of chitin powder and chitin substrate, respectively, and C represents no treatment prior to hydrolysis. ^{31,33,35,36-38} | 26 |
| Figure 2-5. Structure of chitin polymer, and mechanisms of endo-acting and exo-acting enzymes on the chitin during hydrolysis. | 28 |
| Figure 2-6. MALDI-TOF spectrum of the chitin oligomers with DA 90%. Reprinted with permission from Trombotto et al. ⁴² Copyright 2008 American Chemical Society. | 38 |
| Figure 3-1. Crystallite size (nm) of chitin in sodium acetate buffer (pH 6.0) after autoclaving at 121 °C for time durations between 15 and 60 min. Control represents non-autoclaved chitin in the same solution. Different letters above each bar indicate significant differences (P<0.05) between pre-treatment conditions..... | 63 |
| Figure 3-2. ¹³ CP/MAS NMR spectra of control and thermal pre-treated chitin in sodium acetate buffer with pH 6.0 at 121 °C between 15 and 60 min. | 65 |
| Figure 3-3. HPLC chromatography of (a) standard GlcNAc ₂ and (b) sample GlcNAc ₂ obtained in this study (i.e. hydrolysate obtained by reacting pre-treated chitin sample, i.e. PC-60, with chitinase from <i>Streptomyces griseus</i> at 40 °C for 24 h). | 67 |
| Figure 3-4. Mass spectra obtained by LC/MS of the hydrolysate formed from PC-60 after hydrolysis at 40 °C for 24 h by chitinase obtained from <i>Streptomyces griseus</i> | 67 |
| Figure 3-5. Time course of enzymatic hydrolysis of pre-treated (PC-60) and untreated (control) chitin with chitinase from <i>Streptomyces griseus</i> at 40 °C. Different small and capital letters indicate significant differences (P<0.05) between incubation time (h) and pre-treatment conditions, respectively..... | 68 |
| Figure 3-6. Effect of GlcNAc ₂ on the growth of <i>E.coli</i> at 37 °C for 24 h..... | 70 |
| Figure 3-7. Effect of GlcNAc ₂ on the growth of <i>L.monocytogenes</i> at 37 °C for 24 h.... | 71 |
| Figure 4-1. Changes in the TPA of control (●) and GlcNAc ₂ -coated (×) RTE shrimp occurring during 16 days of storage at 4 °C. Small and capital letters indicate significant differences (P<0.05) of control and GlcNAc ₂ -coated samples during storage, respectively. | 85 |

Figure 4-2 . TBARS values for control and GlcNAc₂-coated RTE shrimp during 16 days of storage at 4 °C. Small and capital letters indicate significant differences ($P<0.05$) of control and GlcNAc₂-coated samples during storage, respectively.88

Figure 4-3. Moisture content changes in control and GlcNAc₂-coated RTE shrimp during 16 days of storage at 4 °C. Small and capital letters indicate significant differences ($P<0.05$) of control and GlcNAc₂-coated samples during storage, respectively.88

Figure 4-4. Growth of *L. monocytogenes* in control and GlcNAc₂-coated RTE shrimp during 16 days of storage at 4 °C. Small and capital letters indicate significant differences ($P<0.05$) of control and GlcNAc₂-coated samples during storage, respectively. Asterisk (*) indicates significant differences ($P<0.05$) between samples over storage time.90

List of Tables

| | |
|---|----|
| Table 3-1. Effect of autoclaving chitin at 121 °C (204.7 kPa) for various times on the reducing sugar content and crystallinity index (I _{CR}). | 63 |
| Table 4-1. Changes in surface colour of control and GlcNAc ₂ -coated samples during 16 days of storage at 4 °C. | 87 |

Chapter 1 : Introduction

1. Introduction

Chitin, a naturally abundant biopolymer, found in crustacean shells like shrimp and crab, has been attracting a great deal of attention due to its excellent properties such as biocompatibility, biodegradability, non-toxicity and adsorption properties, which make it a highly functional material.^{1,2} Chitin structure consists of *N*-acetylglucosamine linkages and is highly insoluble in normal solvents or water. In order to fully explore the potential of this biopolymer, it is necessary to convert it into chitosan or oligomers, which substantially improves its solubility. Chitosan, a deacetylated form of chitin, is able to dissolve in solvents such as acetic acid, whereas the chitin oligomers, a shorter chain chitin consisting mainly of two to ten *N*-acetylglucosamine linkages, are highly soluble in water.

The method of producing chitin oligomers by hydrolysis, either enzymatically or by using acids, has been extensively discussed (Abidin *et al.*³). As acidic hydrolysis requires strong inorganic acids, e.g. hydrochloric acid, an alternative and chemically less aggressive method such as enzymatic hydrolysis using chitinases has been explored in order to reduce the environmental impact. However, the enzymatic hydrolysis is significantly slower than acidic hydrolysis and economically not viable due to the difficulties in obtaining commercial chitinase. In order to improve and intensify enzymatic hydrolysis, a number of adjunct treatments have been proposed, prior to or during hydrolysis, which include physical and chemical methods that improve solubility and decrystallisation of the chitin.³ These treatments have been reported to increase the yield of oligomers whilst accelerating the rates of the enzymatic reaction.⁴⁻⁸

As a water-soluble and lower molecular weight conversion product of chitin, the oligomers possess antimicrobial activity which can potentially be applied on food contact surfaces. The antimicrobial activity of chitin oligomer mix (dimer to heptamer, as well as some monomer) inhibits Gram-negative as well as Gram-positive strains.^{4,9,10} Despite its high functionality and relative ease of preparation, chitin oligomers have not been as extensively studied in literature as chitosan. Unlike chitin oligomers, a solvent is required for solubilising chitosan and turning it into a functional material. The net antimicrobial effect is due to a combination of chitosan and acetic acid. It has been reported that a 0.5% solution of acetic acid (pH 4.33) is capable of inhibiting pathogenic bacteria on its own.¹¹

In practical terms, antimicrobial agents can be made to take effect by coating on packaging or on food surfaces. Coating involves the application of the antimicrobial solution directly on the surface, followed by draining and drying until a thin layer of film is formed on the surface.¹² Recently, the effects of employing chitosan as an antimicrobial coating on ready-to-eat (RTE) food products such as meats, seafood, fruits and vegetables have been reported.¹³⁻¹⁶ The RTE food products are becoming more popular these days because of their convenience and fresh appearance.¹⁷ One possible way of enhancing the keeping quality of RTE foods is by using active packaging, for instance packaging that contains an antimicrobial coating. Published literature is replete with information on the production of chitosan and assessing its functionality. But there is relatively little information on chitin oligomer production and applications. This thesis primarily focuses on the production aspects of chitin oligomers and investigates their antimicrobial potency. As a practical application, this thesis also investigates the possible extension of shelf life of RTE shrimps (cooked), by coating shrimp surfaces with chitin oligomers.

2. Objectives

The specific objectives of this research are:

- i. To critically assess the chitin pre-treatments methods reported in literature, in order to improve subsequent conversion into oligomers.
- ii. To explore the use of thermal autoclaving as a pre-treatment method for chitin, in order to improve the yield and functionality of chitin oligomers formed.
- iii. To determine the antimicrobial activity of chitin oligomers against Gram-negative (*Escherichia coli*) and Gram-positive (*Listeria monocytogenes*) strains.
- iv. To explore the effect of coating the oligomer solution on the quality of RTE cooked shrimps.
- v. To observe the inhibitory effect of the oligomer coating against *L. monocytogenes* inoculated on the RTE shrimp.

This thesis has been written in the format of a series of published (and to be published) papers, and it consists of five main chapters. The assessment of chitin pre-treatment methods is included in the literature review presented in **Chapter 2**. This is followed by a detailed experimental study exploring thermal autoclaving of chitin as a pre-treatment prior to enzymatic hydrolysis in **Chapter 3**. This chapter also concludes that the oligomer is predominantly a dimer GlcNAc₂ and assesses its antimicrobial effects against model Gram-negative and Gram-positive strains. The studies on the application of GlcNAc₂ as

a coating on RTE shrimp and its inhibition against *L. monocytogenes* inoculated on shrimp meat is reported in **Chapter 4**. Finally, **Chapter 5** presents the overall conclusions of the research and makes recommendations for related future work.

Chapter 2 and **Chapter 3** have already been published and **Chapter 4** will shortly be submitted for publication:

Abidin MZ, Junqueira-Gonçalves MP, Khutoryanskiy VV, Niranjana K, Intensifying chitin hydrolysis by adjunct treatments – an overview. *J Chem Technol Biotechnol* **92**: 2787–2798 (2017).

Abidin MZ, Kourmentza C, Karatzas K, Niranjana K, Enzymatic hydrolysis of thermally pre-treated chitin and antimicrobial activity of *N,N'*-diacetylchitobiose. *J Chem Technol Biotechnol* **94**: 2529-2536 (2019).

Abidin MZ, Kourmentza C, Karatzas K, Niranjana K, The effectiveness of *N,N'*-diacetylchitobiose (GlcNAc₂) as antimicrobial coating against *Listeria monocytogenes* on ready-to-eat shrimp. (To be submitted for publication)

References

1. Kumar MNR, A review of chitin and chitosan applications. *React Funct Polym* **46**: 1-27 (2000).
2. Kasaai MR, A review of several reported procedures to determine the degree of N-acetylation for chitin and chitosan using infrared spectroscopy. *Carbohydr Polym* **71**: 497-508 (2008).
3. Abidin MZ, Junqueira-Gonçalves MP, Khutoryanskiy VV, Niranjana K, Intensifying chitin hydrolysis by adjunct treatments – an overview. *J Chem Technol Biotechnol* **92**: 2787–2798 (2017).
4. Abidin MZ, Kourmentza C, Karatzas K, Niranjana K, Enzymatic hydrolysis of thermally pre-treated chitin and antimicrobial activity of *N,N'*-diacetylchitobiose. *J Chem Technol Biotechnol* (2019); <https://doi.org/10.1002/jctb.6043>
5. Osada M, Miura C, Nakagawa YS, Kaihara M, Nikaido M, Totani K, Effect of sub- and supercritical water pretreatment on enzymatic degradation of chitin. *Carbohydr Polym* **88**: 308–312 (2012).
6. Roy I, Mondal K and Gupta MN, Accelerating enzymatic hydrolysis of chitin by microwave pretreatment. *Biotechnol Prog* **19**: 1648-1653 (2003).
7. Villa-Lerma G, González-Márquez H, Gimeno M, López-Luna A, Bázquez E and Shirai K, Ultrasonication and steam-explosion as chitin pretreatments for chitin oligosaccharide production by chitinases of *Lecanicillium lecanii*. *Bioresour Technol* **146**: 794-798 (2013).
8. Villa-Lerma G, González-Márquez H, Gimeno M, Trombotto S, David L, Ifuku S and Shirai K, Enzymatic hydrolysis of chitin pretreated by rapid depressurization from supercritical 1, 1, 1, 2-tetrafluoroethane toward highly acetylated oligosaccharides. *Bioresour Technol* **209**: 180-186 (2016).
9. Benhabiles MS, Salah R, Lounici H, Drouiche N, Goosen MFA, Mameri N, Antibacterial activity of chitin, chitosan and its oligomers prepared from shrimp shell waste. *Food Hydrocoll* **29**: 48–56 (2012).
10. Raut AV, Satvekar RK, Rohiwal SS, Tiwari AP, Gnanamani A, Pushpavanam S, Nanaware SG, Pawar SH, In vitro biocompatibility and antimicrobial activity of chitin monomer obtain from hollow fiber membrane. *Des Monomers Polym* **19**: 445–455 (2016).
11. Bjarnsholt T, Alhede M, Jensen PØ, Nielsen AK, Johansen HK, Homøe P, Høiby N, Givskov M, Kirketerp-Møller K, Antibiofilm properties of acetic acid. *Adv Wound Care* **4**: 363–372 (2015).
12. Jin TZ, Antimicrobial packaging in combination with nonthermal processing, in *Packaging for Nonthermal Processing of Food*, ed by Malvin AP, Jung HH. Wiley-Blackwell, pp 43-62 (2018).

13. Quesada J, Sendra E, Navarro C, Sayas-Barberá E, Antimicrobial active packaging including chitosan films with *Thymus vulgaris* L. essential oil for ready-to-eat meat. *Foods* **5**: 1–13 (2016).
14. Rico D, Barcenilla B, Meabe A, González C, Martín-Diana AB, Mechanical properties and quality parameters of chitosan-edible algae (*Palmaria palmata*) on ready-to-eat strawberries. *J Sci Food Agric* **99**: 2910–2921 (2018).
15. Leceta I, Molinaro S, Guerrero P, Kerry JP, De la Caba K, Quality attributes of map packaged ready-to-eat baby carrots by using chitosan-based coatings. *Postharvest Biol Technol* **100**: 142–150 (2015).
16. Silberbauer A, Schmid M, Packaging concepts for ready-to-eat food: Recent progress. *J Packag Technol Res* **1**: 113–126 (2017).
17. Carrión-granda X, Fernández-pan I, Jaime I, Rovira J, Maté JI, Improvement of the microbiological quality of ready-to-eat peeled shrimps (*Penaeus vannamei*) by the use of chitosan coatings. *Int J Food Microbiol* **232**: 144–149 (2016).

Chapter 2 : Literature Reviews

(Published as “Abidin MZ, Junqueira-Gonçalves MP, Khutoryanskiy VV, Niranjan K, Intensifying chitin hydrolysis by adjunct treatments – an overview. *J Chem Technol Biotechnol* **92**: 2787–2798 (2017)”)

1. Introduction

Chitin - a β -(1 \rightarrow 4)-linked polymer composed predominantly of *N*-acetyl-D-glucosamine (GlcNAc) units – is, after cellulose, the most abundant organic natural polysaccharide on earth, offering a broad range of structural and protection functions, like cellulose in plants. The structure of chitin differs from that of cellulose in that the C-2 hydroxyl residues (-OH) are replaced by acetamide groups (CH₃CONH-) (Figure 2-1). Chitin comprises three polymorphs: α -chitin is the most abundant and β - and γ -chitin are very rare, which can be distinguished by their molecular chain arrangement and hydrogen bonding systems. α - and β -Chitins have an antiparallel and a parallel chain arrangement, respectively, whereas γ -chitin consists of both parallel and antiparallel chains.^{1,2} The antiparallel chain in α -chitin are arranged in bonded piles or sheets linked together by the hydrogen and acetamide groups running in opposite directions as compared to the β -chitin.² The intermolecular and hydrogen bonds present in α -chitin make it difficult to melt and dissolve in common solvents at normal temperatures, which makes this material inconvenient for further processing.¹

Chitin is synthesized as a dominant component in the exoskeletons of crustaceans and insects, as well as in the cell wall of fungi, yeast and algae. Nowadays, chitin extracted from crustacean shells, such as crab, shrimp, prawn, krill and lobster, are readily available

in large quantities from shellfish processing industries in comparison with other sources. In the processing of seafood for human consumption, between 40 and 50% of the total raw material mass is wasted.³ This quantity of waste has been reported to be between 10^{10} and 10^{11} tons per year, which poses a significant problem for the environment due to its slow degradation.³⁻⁶

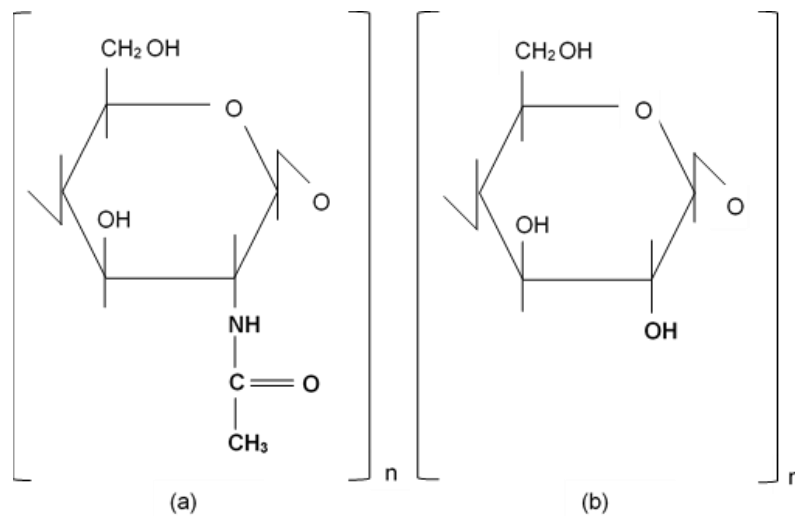

Figure 2-1. Chemical structures of: (a) Chitin and (b) Cellulose

Crustacean shells are composed of proteins, chitin, minerals, and carotenoids, which are the major components based on the dry mass.³ In order to extract chitin from the crustacean shells, the following main steps must be employed: demineralization, deproteinization and decolouration.⁷ The demineralization of shells can be achieved by extraction with dilute acid (hydrochloric acid, formic acid, acetic acid, sulfuric acid or EDTA – ethylenediamine-tetra-acetic acid) at room temperature. Deproteinization can be effected by treating the demineralized waste with aqueous alkali solution (sodium or potassium hydroxide) at the temperatures between 65 and 100 °C. In this step, the most significant parameters to be considered for an efficient deproteinization are the concentration of alkali solution, processing time and temperature, and solid to solvent ratio. Benhabiles et al.⁸ reported that the conditions for 96% protein removal were:

processing time of 120 mins at a temperature of 45 °C and the use of solid to solvent ratio of 1:2 (w/v) with the solvent (NaOH solution) concentration being 2 M. Finally, the decolouration was carried out by a bleaching with activated charcoal, or by using strong oxidizing agents such as sodium hypochlorite (NaClO) or hydrogen peroxide (H₂O₂) solutions.⁹ Chitin separated from minerals, colourants and proteins is commercially available for industrial uses, although, it may require further purification in order to obtain regenerated chitin, which can be effectively used for producing chitosan and oligomers.¹⁰⁻

12

Chitosan - a β -(1 \rightarrow 4)-linked polymer composed predominantly of D-glucosamine (GlcN) units - is an *N*-deacetylated derivative of chitin formed by deacetylation under alkaline conditions at elevated temperature, which sodium hydroxide is a common alkaline media.^{4,13-15} Chitosan is a semi-crystalline polymer which is insoluble in aqueous solutions above a pH value of 6.5, but fully soluble in diluted acids below pH of 5.^{16,17} The difference between chitin and chitosan can be defined in terms of the ratio of 2-acetamido-2-deoxy-D-glucopyranose to 2-amino-2-deoxy-D-glucopyranose units, which is commonly known as degree of *N*-acetylation (DA). The DA of chitosan is typically less than 0.35, whereas that of chitin is normally above 0.90.¹⁵ Higher and lower molecular weight chitosans may also possess excellent properties for specific applications. Numerous studies have reported that chitosan with higher molecular weight possess superior mechanical properties, such as higher tensile strength and better elongation of chitosan film,^{18,19} higher antifungal activity,^{20,21} and enhances nasal absorption of peptide drugs²². Lower molecular weight chitosans have a stronger superoxide scavenging activity,²³ greater antimicrobial activity,²⁴ and higher permeability of film.¹⁸

Chitin oligomers are derived from chitin by depolymerization in the presence of acid or enzymes.^{4,13,14} Chitin oligomers are composed of GlcNAc units with approximately ten residues or less, and can be produced by depolymerization of chitin.⁴ The depolymerization is commonly achieved by acid and enzymatic hydrolysis, employing hydrochloric acid (HCl) and chitinases, respectively. The chitin polymer chain is cleaved by this reaction to become oligomeric. Both these hydrolysis methods have been extensively reviewed by Jeon *et al.*, Prashanth and Tharanathan and Ahmed *et al.*^{4,25,26} Efforts to find uses for chitin oligomers have intensified since these chemicals are highly functional and offer a wide range of applications. Chitin oligomers have received increased research and commercial attention because these molecules are not only water soluble, nontoxic and biocompatible, but also exhibit numerous biological properties, such as antibacterial, antifungal, antitumor, and antioxidant activities.²⁷⁻³⁰ According to the literature, antimicrobial action is one of the most important property of chitin oligomers due to its water solubility, and potent activity against bacteria and moulds. It has been reported that the oligomer possess low minimal inhibitory concentrations (MIC) values for gram-positive strain (*S. aureus*, *B. subtilis*, *L. monocytogenes* and *B. cereus*) and gram-negative strains (*E. coli*, *V. cholera*, *Shigella dysenteriae*, *B. fragilis*, *P. aeruginosa*, and *P. melaninogenica*) compared to chitin and chitosan.^{27,31} In another research, the chitin oligomers were found to possess antifungal activity against *Aspergillus niger*.²⁸ Besides antimicrobial activity, some works also reported that the chitin oligomers, with molecular weight of 1-5 kDa, possess the ability to inhibit membrane protein oxidation and act as potent antioxidant in live cells.^{30,32}

As a consequence of growing interest for converting chitin into its oligomers, some adjunct treatments, either chemical or physical in nature, have been employed to assist

acid and enzymatic hydrolysis, as well as enhance the yield of oligomers. Gamma irradiation, ultrasonication, microwave irradiation, steam explosion, supercritical water, grinding and depressurization are physical methods that have been employed previously to facilitate chitin hydrolysis.³³⁻³⁸ Aqueous solutions such as phosphoric acid, hydrochloric acid, alkaline solution and methanol modify chitin structures prior to hydrolysis. These chemical treatments have been reported to decrystallise chitin, increase its solubility, and accelerate subsequent enzyme hydrolysis.^{11,12,39}

2. Preparation of chitin oligomers

This section reviews the different hydrolysis methods employed and adjunct treatments proposed to assist depolymerization of chitin.

2.1 Methods based on acidic hydrolysis

Chitin oligomers are generally manufactured by acid hydrolysis of chitin employing strong acids such as concentrated hydrochloric acid (HCl) to effect the cleavage of the chitin polymeric chain.^{27,30,34,40-42} The concentration of HCl, incubation time and temperature are the key parameters in the process. HCl concentrations ranging from 3 to 12 N have been used to hydrolyse chitin at temperatures ranging between 20 and 90 °C for time durations ranging between 5 min and 7 h.^{27,30,32,40-42,44,45} The processing steps employed by earlier researchers for hydrolysing chitin are summarized in Figure 2-2. In general, a given amount of chitin powder is added to HCl solution and the mixture is constantly stirred under reflux in a water bath maintained at the desired temperature.^{32,40,42} After incubating this for the desired time period, the hydrolysis is stopped by cooling the reaction mixture in an ice bath or on dry ice,^{40,44} following which, the chitin oligomers

are isolated by: 1) freeze-drying the solution under vacuum, 2) redissolving the dried product in deionised water, and 3) neutralising the solution with NaOH followed by filtration to remove impurities from the oligomers. The freeze-drying and redissolving steps have been repeated twice by some researchers to remove any residual HCl left.⁴² Some researchers have also proposed neutralisation with 25% sodium hydroxide (NaOH) to stop the hydrolysis.^{30,32} The neutralised solution is centrifuged to separate the supernatant, and the unhydrolysed chitin and the supernatant are desalted and purified prior to spray-drying in order to obtain the chitin oligomers as a light yellow powder.

Recently, Kazami *et al.*⁴⁵ developed an acetone precipitation method as a replacement to NaOH neutralisation to claim a simpler procedure for isolating the chitin oligomers. Acetone-insoluble material can be recovered by the following steps: 1) adding acetone to stop the hydrolysis and stirring at a low temperature for a day; 2) centrifuging the mixture of acetone and chitin; 3) repeatedly washing the acetone-precipitate with acetone to remove HCl (until the pH of supernatant reaches 4-5); and 4) suspending the acetone-precipitate in cold diethyl ether, centrifuging and drying to constant weight.

The dried acetone-precipitate (acetone-insoluble material) is then mixed with water in order to extract the water-soluble chitin oligomers as follows: 1) mixing the dried acetone-precipitate with water, stirring overnight, and centrifuging in order to separate the supernatant and water-precipitate; 2) repeating step (1) for the water-precipitate; 3) combining supernatant recovered from steps (1) and (2) as water-soluble chitin oligomers; and 4) suspending the water-precipitate in cold diethyl ether, centrifuging and drying to constant weight. Generally, the supernatant containing the chitin oligomers obtained appear brown or yellow in colour. Therefore, activated charcoal treatment is applied to yield a clear solution prior to the final drying process.^{34,42}

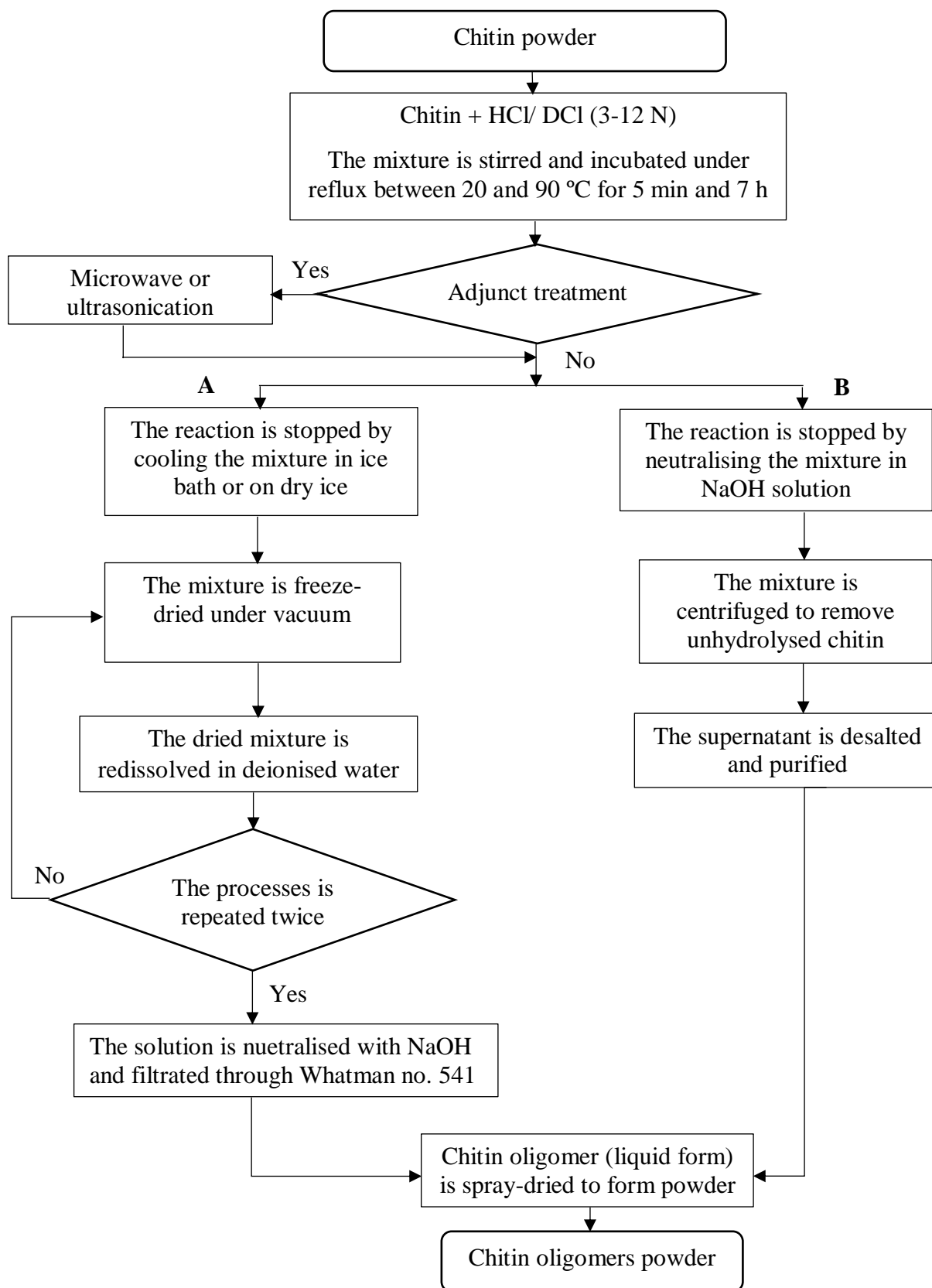

Figure 2-2. Process flowsheet for acid hydrolysis of chitin with or without adjunct treatment. A and B represent different method for recovering chitin oligomers from the reaction mixture.^{27,30,32,40-42,44,45}

Chitosan can also be potentially converted into chitin oligomers by employing a two-step process involving: 1) depolymerization of chitosan by hydrolysis in HCl to form chitosan oligomers; and 2) partial *N*-acetylation of chitosan oligomer in hydro-alcoholic solution of acetic anhydride in order to produce the oligomers.⁴² This approach generally requires numerous steps and produces HCl and acetic anhydride residues, which are undesirable products and have a significant impact on the environment.

Figure 2-3 shows a possible mechanism of chitin hydrolysis by concentrated HCl that has been reported previously by Kazami et al.⁴⁵ The chitin before hydrolysis is assumed to consist of alternating crystalline and amorphous regions, and composed a number of polymeric chains. Initially, the amorphous regions are rapidly cleaved within 5 min of hydrolysis to produce regular-sized segments with a central crystalline region attached to amorphous tails at both ends. The amorphous tails are then gradually degraded, leading to the accumulation of chitin oligomers, as well as a crystalline chitin core consisting of multiple chitin chains. Single chitin chains may then be slowly separated from the chitin core, and once separated, be rapidly hydrolysed to yield chitin oligomers within 30 to 60 min.

Although the hydrolysis process described above is effective, some disadvantages have been reported such as the occurrence of deacetylation (that produces chitosan oligomers instead of chitin oligomers), production of acidic waste streams, high cost, lower yield of high degree of polymerization (DP) oligomers, and requiring skilled labour force for purification.^{4,11,25} The lower yield and shorter chain length of the oligomers formed, particularly dimers, adversely influence bioactivity.⁴⁶ In addition, the process costs and the environmental impact of the process are also high mainly due to the use of strong acids during hydrolysis.⁶

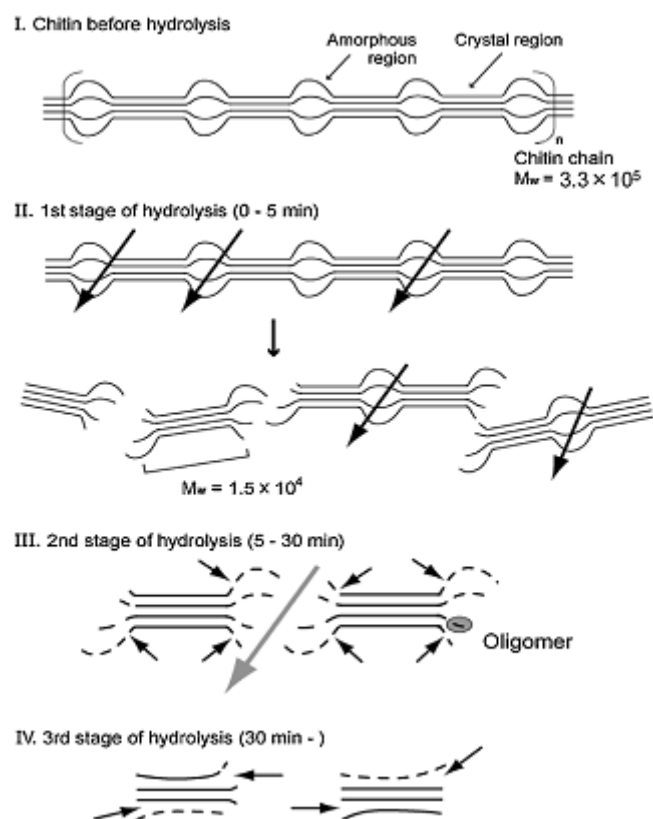

Figure 2-3. Possible mechanism of chitin hydrolysis in concentrated HCl. Reprinted with permission from Kazami et al.⁴⁵ Copyright 2015 Elsevier.

2.2 Methods based on enzymatic hydrolysis

In contrast to acidic hydrolysis, higher DP chitin oligomers can be produced under milder reaction conditions by employing enzymatic hydrolysis. Enzymes, mainly chitinases, which have higher chitinolytic activity, are used for this purpose, and are commonly produced from microorganisms, plants, and insects. Some researchers have used

bacterium *Serratia proteamaculans* 568,⁴⁷ *Serratia marcescens* 2170,⁴⁸ *Rhizobium* sp. GRH2,⁴⁹ *Bacillus cereus* TKU027,⁶ to produce chitinases, while others have used hevamine,⁵⁰ a plant enzyme, having both chitinase and lysozyme activities. Chitinases can also be successfully extracted from fungi such as *Lecanicillium lecanii* and *Lecanicillium fungicola*, while *Trichoderma reesei* fungi is reported to have hydrolases (cellulases and β -glucanases).^{11,36,39} The enzymes produced from various sources have to be purified before being used for hydrolysis. Additionally, non-chitinase commercially available enzymes, like cellulase, hemicellulase, pepsin, papain, lysozyme, and pectinase have also been reported to hydrolyse chitin.^{12,31,51}

A flow diagram for the enzymatic hydrolysis of chitin is showed in Figure 2-4. Prior to hydrolysis, the substrate or chitin suspension is prepared by adding chitin powder to a phosphate or acetate buffer solution, so that its concentration is between 0.5 and 2.0% w/v.^{6,12,33,48,51} Buffers strength in the range of 0.01 to 0.05 M and pH 5.0 to 5.5, are reported to provide optimum condition for the substrate preparation.^{6,12,31,36,51} The enzyme is subsequently mixed with the substrate at an appropriate amount, so that its chitinolytic activity in the system is under the standard assay condition. In the hydrolysis, one unit of enzyme activity (1 U) is defined as the amount of enzyme releasing 1 μ mol GlcNAc per minute.⁵² After mixing, the mixture is incubated at various temperature-time combinations, depending on the enzyme action. Hydrolysis by chitinases, lysozyme, pectinase, and pepsin have been reported to require incubation at temperatures between 37 and 44 °C.^{6,12,36,47,48,50,51} To stop the reaction, the hydrolysis mixture is heated to 90 °C or boiled for 10 min, and subsequently centrifuged and filtered to separate the supernatant which contains the oligomers, and unhydrolysed chitin.^{11,31,36,51}

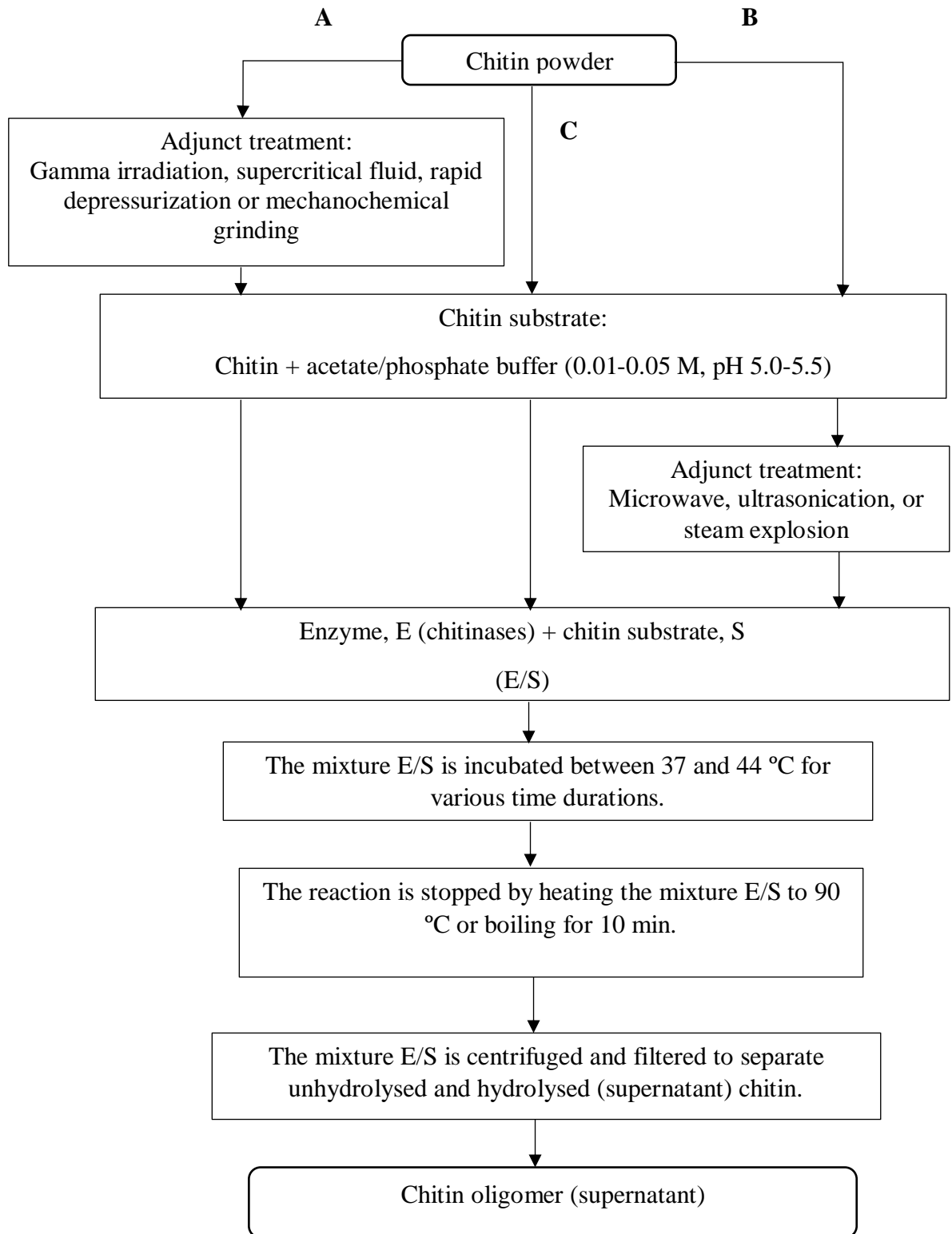

Figure 2-4. Flow diagram for the enzymatic hydrolysis on chitin with or without adjunct treatment. A and B represent treatment of chitin powder and chitin substrate, respectively, and C represents no treatment prior to hydrolysis.^{31,33,35,36-38}

Earlier studies have reported that the yield of high DP chitin oligomer resulting from enzymatic hydrolysis is greater compared to acidic hydrolysis.⁴ This may be due to the enzyme acting selectively on the crystalline and otherwise inaccessible parts of chitin. During chitin hydrolysis, the enzymes which degrade the polysaccharide chain can be either endo-acting or exo-acting. Figure 2-5 shows the mechanism of endo-acting enzymes which randomly cleave glycosidic linkages of chitin, generate free ends and chitin oligomers, while exo-acting enzymes release dimers (two units of GlcNAc) from the reducing (C1) or non-reducing (C4) ends.⁴⁷

Of course, the use of enzymes also has its fair share of disadvantages: specific enzymes such as chitinase and chitosanases are not readily available commercially and, even if available, tend to be very expensive.³⁷ Furthermore, the presence of protein residues after hydrolysis potentially limit biomedical application due to possible allergen and pyrogenicity effects,²⁵ which will warrant significant further purification that will make the whole process economically unviable. However, this method has a key advantage because minimum chemical wastes are produced during hydrolysis.⁶

2.3 Use of chemical and physical adjunct treatments to intensify chitin hydrolysis

Irradiation of chitin has recently been used to assist acid or enzymatic hydrolysis. Ultrasonic irradiation or ultrasonication has been reported to be advantageous for depolymerisation, because it preserves the chemical nature of the polysaccharide by simply splitting the most susceptible chemical bonds and lowering its molecular weight.⁵³ Takahashi *et al.*⁵⁴ and Ajavakom *et al.*³⁴ determined the effectiveness of ultrasonication during acid hydrolysis. In these investigations, the mixture of chitin and HCl was sonicated at various wavelengths for different durations. It has been found that the chitin

powder completely dissolved within 30 min in the HCl solution during sonication at 50 or 60 Hz (275 W).³⁴ Takahashi et al.⁵⁴ noted that the amount of oligomers up to DP 7 (seven units of GlcNAc in each chain) increased after 120 min of ultrasonication, which was 2 to 4 times greater than oligomers produced without ultrasonication. On the other hand, the chitin could be degraded during demineralisation in an ultrasound-assisted extraction process. The depolymerisation occurring may be due to the application of high intensity irradiation, which results in breaking covalent bonds in the polymeric chain.⁵⁵ Ultrasonication has also been applied to the chitin suspension prior to enzymatic hydrolysis. In this process, the treated chitin depolymerized to a lesser extent, which was detected by the lower amount of reducing sugars measured.³⁶ All these studies agreed that ultrasonication facilitated acidic and enzymatic hydrolysis without drastically changing the degree of acetylation (DA) of the chitin. However, if high intensity ultrasonication was applied, the covalent bond in the polymeric chains of chitin could break due to cavitation by temporarily dispersing aggregates.⁵⁵

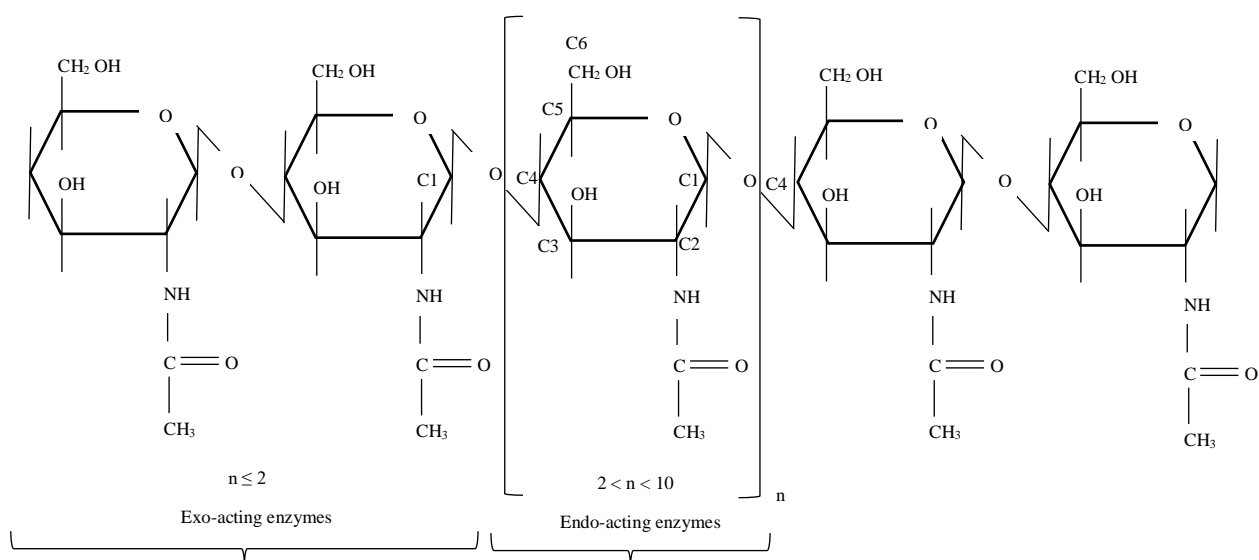

Figure 2-5. Structure of chitin polymer, and mechanisms of endo-acting and exo-acting enzymes on the chitin during hydrolysis.

Some researchers have measured ultrasonic intensity directly, while others have not. When the intensity is not measured, it is calculated by measuring the transient rise in temperatures during ultrasonication, and after it is switched off, as follows:

$$I = \frac{mc_p}{\pi r^2} \left[\left(\frac{dT}{dt} \right)_a - \left(\frac{dT}{dt} \right)_b \right] \quad (1)$$

where: I is the ultrasonic intensity, $(dT/dt)_a$ is the slope of the initial rise in temperature, $(dT/dt)_b$ is the slope of heat loss after the ultrasonic processor was turned off, m is the sample mass, c_p is the heat capacity of the solvent, and r is the radius of ultrasonic probe.⁵⁵

Microwave irradiation has been established as a patented technique for producing chitin oligomers. Chitin is added to HCl and subjected to a conventional microwave device at 700 to 2100 W for up to 24 h.⁵⁶ This technique has been repeated by other researchers with a slight modification, where 38% HCl was initially pre-warmed at 850 W by conventional microwave oven for a shorter time and the pre-warmed HCl was quickly added to chitin powder for further irradiation at various reaction times.³⁴ Microwave irradiation has also been applied prior to the enzymatic hydrolysis of chitin. Roy et al.³³ used a microwave with built-in magnetic stirrer and non-contact infrared continuous feedback temperature system for chitin pre-treatment. In this study, the chitin suspended in acetate or phosphate buffer was irradiated with the microwave at optimum temperature and time reported to be 57.5 °C and 38 min, respectively; this was followed by hydrolysis with chitinase. This study found that the polar molecules in the chitin suspension align with the magnetic field generated by microwave, and have a tendency to accelerate the hydrolytic reaction rate. The microwave pre-treatment is comparable to ultrasonication, when the treated chitin is insignificantly deacetylated after irradiation.³³

Improvement on the hydrolysis rate and chitin properties could be accomplished by gamma irradiation, which is one of the physical methods requiring no chemical additive and no temperature control during reaction.^{37,38} Gamma irradiation, applied at different doses ranging from 15 to 210 kGy, to the solid form of chitin, prior to hydrolysis with chitinases, has been investigated.³⁷ Previously, this method was effectively applied as the adjunct treatment in the production of chitosan oligomer, using irradiation doses ranging between 2 and 500 kGy.⁵⁷⁻⁵⁹ These authors suggested that the application of gamma irradiation at various doses may reduce the molecular weight of oligomers due to the breaking of glycoside bond.

The adjunct treatments discussed above are physical methods which influence the reaction through non-thermal effects. However, thermal treatments, such as steam explosion (SE), has also been investigated to influence the enzymatic hydrolysis of chitin. Steam explosion treatment consists in heating of chitin with saturated steam, followed by a sudden decompression of the pressurized system to produce insoluble solid fraction and a liquid fraction of soluble sugars.^{60,61} Villa-Lerma et al.³⁶ applied steam explosion to the mixture of chitin powder and deionized water at 180 °C and 1 MPa for various reaction times. The treated chitin mixture was then added to phosphate buffer and this combination acted as substrate for hydrolysis with chitinase. It has been reported that steam explosion can significantly reduce chitin crystallinity without significant depolymerisation occurring during treatment.

Another physical treatment that has been proposed to enhance and increase the oligomers yield is a combination of the use of supercritical water and mechano-chemical grinding with a ball mill.³⁵ Supercritical water is water at temperatures near or above 374 °C, meanwhile, the mechano-chemical grinding is a term used for the chemical reaction that

occurs during mechanical treatment of the sample, typically grinding by ball mill.⁶²⁻⁶⁴ After being treated with supercritical water, the chitin undergoes mechano-chemical grinding. This pre-treatment results in chitin flakes which are fragile and easy to grind, and form an effective substrate for hydrolysis with reduced particle size and molecular weight.³⁵

In addition, chitin structures can also be pre-treated chemically by using aqueous solution, such as phosphoric acid, HCl, alkaline solution (mixture of sodium hydroxide and sodium dodecylsulfate), and methanol. These pre-treatments have reportedly decrystallised chitin, increased its solubility, and accelerated subsequent enzyme hydrolysis.^{11,12,39} Ramírez-Coutiño et al.³⁹ deacetylated α and β -chitin by deacetylation with alkali solution, thereby partially transforming chitin into chitosan (degree of deacetylation 55 and 50%, respectively) prior to hydrolysis. Reduction in hydrogen bonds caused by the elimination of acetyl group increases the solubility of partially deacetylated chitin in aqueous media.^{65,66}

3. Characteristics and characterization of chitin and its oligomers

This section summarizes the various methods used in literature to characterize chitin oligomers produced by chitin hydrolysis with and without the use of adjunct processes. Chemical structure and composition, degree of *N*-acetylation (DA), degree of polymerization (DP), molecular weight, and crystallinity are important properties characterizing chitin oligomers. The methods employed to determine these characteristics are discussed below.

3.1 Chemical structure and composition

Fourier transform infrared (FT-IR) and proton nuclear magnetic resonance ^1H NMR spectroscopies can be reliably used to record the composition and chemical structure of the oligomers.^{30,32,34,36,37,39,41-43,55} These methods require simpler procedures to prepare samples, and provide information on the chemical structure faster than conventional methods.⁶⁷

3.1.1 Fourier transform infrared spectroscopy (FT-IR)

FT-IR spectroscopy is a very attractive technique suitable for both soluble and insoluble samples.⁶⁸ The technique is based on the vibrations of the atoms of a sample molecule. Infrared spectrum is obtained by passing infrared radiation through the sample and determining the fraction of the incident radiation absorbed at a particular energy. The energy at any peak in an absorption spectrum corresponds to the frequency of a vibration of a part of the sample.⁶⁹

The infrared spectrum can be divided into three main frequencies which is far-infrared ($< 400\text{ cm}^{-1}$), mid-infrared ($4000 - 400\text{ cm}^{-1}$) and near-infrared ($13000 - 4000\text{ cm}^{-1}$). To obtain the FT-IR spectrum of the chitin and its oligomers, mid-infrared frequency is used as explained by Lambert-Beer Law.^{27,30,36,55,70} The law states that the absorbance values at a given frequency of 4000 to 400 cm^{-1} are proportional to the concentrations of the sample. Measurements are initiated by preparing KBr (potassium bromide) pellet, which is a small amount of chitin sample well mixed with the KBr (approximately 0.1 to 1.0% (w/w)) and pressed into a pellet-forming die. The measurement is taken by scattering the infrared light onto the KBr pellet using FT-IR system.^{30,70,71} This is the most common

method used, which utilizes the property of KBr as alkali halide that becomes plastic when subjected to pressure and forms a transparent sheet in the infrared region.⁷²

In a chitin molecule, the acetamido group at the position C2 (Figure 2-5), intramolecular hydrogen bonds (C6-OH \cdots O=C) and intermolecular hydrogen bonds (NH \cdots C=O) provide polymer stability.⁷³ In α form, the absorption bands of carbonyl group (amide I) stretching are split at 1660 cm⁻¹ and 1620 cm⁻¹, which are attributed to intermolecular and intramolecular hydrogen bonds respectively.^{73,74} Unlike a crystalline form, a single absorption band of amide I β -chitin is observed at 1560 cm⁻¹ which is attributed to the stretching of carbonyl group hydrogen bonded to amide group of the intra-sheet chain.⁷⁴ In previous research, α -chitin extracted from *Daphnia magna* resting egg (zooplankton genus in aquatic ecosystems) exhibited absorption bands at 1652 cm⁻¹ and 1622 cm⁻¹ for amide I.⁷³ Recently, the chitin extracted from six different aquatic invertebrates presented the spectrum of amide I at 1652-1656 cm⁻¹ and 1619-1620 cm⁻¹, thus allowing them to be characterized as a crystalline form.⁷⁵ These two strong absorption bands were also observed in ultrasonication and steam explosion treated chitin. However, an additional shoulder was present at 1633 cm⁻¹ in ultrasonication treated chitin which might be due to a reduction in amino-based hydrogen bonding.³⁶ In chitin oligomers structure, the spectrum generated by FT-IR exhibits intense absorption bands at 3358 cm⁻¹ (OH stretch), 2917 cm⁻¹ (C-H stretch), 1651 cm⁻¹ (C=O stretch, amide I), 1548 cm⁻¹ (N-H bend, amide II), 1313 cm⁻¹ (C-N stretch, amide III), and 1150-1000 cm⁻¹ (pyranose).³⁰ All the reported FT-IR spectra indicate that the crystalline structure formation of intact chitin, treated chitin and its oligomers are not affected by the type of process.

3.1.2 Proton nuclear magnetic resonance (^1H NMR) spectroscopy

^1H NMR spectroscopy is a powerful and reliable technique for polymer structural analysis by exploiting the magnetic properties of certain atomic nuclei. The spectra of chitin and its oligomers can be obtained by cross-polarization or magic-angle-spinning method using deuterated oxide (D_2O) as solvent.³¹

In chitin, the chemical composition obtained by ^1H NMR resonated between 3.6 and 4.4 ppm, which are assigned to H-2 to H-6 protons, while acetyl protons are found at 2.6 ppm.^{74,43} The anomeric region of α - and β -anomer (H-1) generated peaks at 5.43 and 5.05 ppm, respectively.⁴³ As observed in chitin oligomers, the spectra present two singlets at 2.06/2.08 ppm assigned to the *N*-acetyl protons, and a broad signal at 5.20 ppm assigned to H-1 protons of the reducing end α anomer residues.⁴² The chitin oligomers produced by enzymatic hydrolysis of chitin using commercial enzymes possessed obvious resonance peak at 1.9 ppm assigned to the acetyl group, 3.4 ppm detected for H-2 and 3.5 to 3.8 ppm corresponding to H-3, H-4, H-5 and H-6 protons, meanwhile the H-1 (β) and H-1 (α) protons generated peaks at around 4.6 to 4.7 ppm and 5.2 ppm, respectively.³¹ Ngo *et al.*³⁰ reported the resonance of chitin oligomers hydrolysed by acid (HCl) at 1.97 ppm is assigned to acetyl group, 3.34 ppm is corresponded to H-2, 3.37 to 3.77 ppm are detected for H-3, 4, 5, 6, 4.5 to 4.6 ppm is assigned to H-1 (β) and 5.0 ppm is corresponded to H-1 (α). All spectra of chitin are essentially identical to the oligomers, regardless of the type of hydrolysis. It is caused by the occurrence of glycosidic linkages breakdown during the hydrolysis without the interference of deacetylation.⁴¹

3.2 Degree of *N*-acetylation

The degree of *N*-acetylation (DA) represents the molar fraction of *N*-acetylated units in the chitin polymer chain.⁷⁶ The DA is an important parameter influencing physico-chemical, electrostatic and biological properties of chitin.⁷⁷ Generally, the DA can be determined by the calculation of the absorbance and intensities generated by FT-IR and NMR, respectively. The absorbance values (A) obtained by FT-IR can be used to measure DA by using the following equation:

$$\% \text{ } N\text{-acetylation} = (A_{1655}/A_{3450})(100/1.33) \quad (2)$$

where, A_{1655} and A_{3450} are the absorbances at 1655 cm^{-1} of the amide-I band and 3450 cm^{-1} of the hydroxyl band, respectively; and the factor of 1.33 is the ratio of A_{1655}/A_{3450} for fully *N*-acetylated chitin.⁵⁵ However, Chang *et al.*⁴⁰ determined the percentage of DA by using the following equation, originally proposed by Baxter *et al.*⁷⁸:

$$\% \text{ } N\text{-acetylation} = (A_{1655}/A_{3450})(115) \quad (3)$$

The values of 100/1.33 (i.e. 75.2) and 115 are reciprocal values of the slope of the linear section of the plot of absorption ratio (A_{1655}/A_{3450}) against DA, which depend on the baselines used.^{67,70} Eq (3) is more reliable in comparison with Eq (2), since Eq (2) tended to overestimate values for $DA > 20$.⁶⁷

The DA can also be quantitatively analysed by carbon nuclear resonance magnetic (C-NMR), where the relative intensities determined for the resonance of the ring carbon (I_{C1} ,

I_{C2} , I_{C3} , I_{C4} , I_{C5} , I_{C6}) and methyl carbon (I_{CH3}) is used in the following equation proposed by Ottey et al.⁷⁹

$$\% N - \text{acetylation} = \frac{I_{CH3}}{(I_{C1}+I_{C2}+I_{C3}+I_{C4}+I_{C5}+I_{C6})/6} \times 100 \quad (4)$$

Eq (4) has been applied in earlier work on chitin.^{68,70,80}

Fully acetylated chitin provides DA of 100% while 0% corresponds to completely deacetylated chitin (chitosan).⁶⁷ In previous work, the DA of chitin decreased from 98 to 93, 88 and 73% after exposure to ultrasonication, steam explosion and depressurization, respectively.^{36,38} The lower DA values after adjunct treatment indicate deacetylation and modification of chitin structure. However, the lowest DA of depressurized chitin gave higher yield of the oligomers. It has been reported that the DA values of chitin between 45 and 55% provide excellent solubility in aqueous media.³⁸ Some authors have reported that the DA between 40 and 60% possessed suitable characteristics for enzymatic hydrolysis, where the chitin solubility reached was greater than 60%.^{39,81} It caused the polarity and electrostatic repulsion of the amino groups increased, thus increasing the accessibility of chitin to enzymatic attack.³⁹

3.3 Degree of polymerization

Degree of polymerization (DP) is a significant parameter to identify the number of monomeric units in the oligomers. MALDI-TOF mass spectrometry is a powerful technique, which has been extensively applied to determine the DP of chitin and chitosan oligomers.^{6,36,42,82,83} Figure 2-6 shows the MALDI-TOF spectra which consists of high intensity of a number of peaks assigned to a certain DP. The DP of the oligomers can be

determined by the peak-to-peak mass difference of 203, which is the GlcNAc repeating unit ($C_8H_{13}NO_5$). The end-groups of H and OH are deduced from monoisotopic mass. Each DP can be calculated from a peak with particular mass unit (m/z) as follows:

$$DP = (\text{mass unit of a peak} - H - OH - Na) / C_8H_{13}NO_5 \quad (5)$$

where DP is the degree of polymerization. The molecular mass of $C_8H_{13}NO_5$ is 203 (i.e. mass unit of chitin oligomers); the atomic mass of H is 1 (hydrogen); and those of the OH group and Na are 17 and 22.99, respectively.⁴²

The DP can also be determined by using high performance liquid chromatography (HPLC), where the concentration of each DP present can be calculated from the peak areas in the HPLC profile using the standard curve obtained from pure chitin monomer, dimer, trimer, tetramer, pentamer, and hexamer standard solution.^{6,11,12,40,57} Moreover, the DP can be quantitatively analysed by integrating the signals of the anomeric protons (H-1 (α) and H-1 (β)) obtained by 1H NMR using the following equation:

$$DP_n = [\int H-1 (\alpha) + \int H-1 (\beta) + \int H-1c] / [\int H-1 (\alpha) + \int H-1 (\beta)] \quad (6)$$

where $\int H-1 (\alpha)$ and $\int H-1 (\beta)$ refer to the integral of the H1 protons of the chitin oligomers at terminal reducing end having α and β configuration, respectively, and $\int H-1c$ is the sum of integrals of the H1 protons of all the central units.⁸⁴

As reported by Chang *et al.*⁴⁰, the chitin hydrolysed in acid (HCl) produced oligomers with DP in the range of 2 to 6. Moreover, the oligomers with DP 4-6 were simply isolated from acetone-precipitation method.⁴⁵ In another study, the chitin oligomers produced by

acetylation of chitosan oligomers with various DA up to 90% using acetic anhydride solution and isolated in HCl resulted in a value of DP ranging from 3 to 7.⁴² As an alternative to acid hydrolysis, enzymatic hydrolysis has been extensively used to obtain oligomers with higher DP. As observed by Wang *et al.*⁶ and Purushotham *et al.*⁴⁷, the oligomers obtained by hydrolysis with chitinases possessed DP in the range between 2 and 9. In theory, the hydrolysis must ultimately lead to the formation of chitobiose (DP 2). However, products with DP 4 and higher show better functional properties as compared to DP 2. Chitinase and lysozyme from heveamine were reported to degrade chitin polymer to form pentamers (DP 5).⁷⁰ Commercial enzymes such as hemicellulase and pectinase have also successfully depolymerized chitin to DP 6.³¹ Based on the above studies, it can be concluded that both acid and enzymatic hydrolysis result in higher DP of chitin oligomers. However, the enzymatic hydrolysis condition is milder than acid hydrolysis.

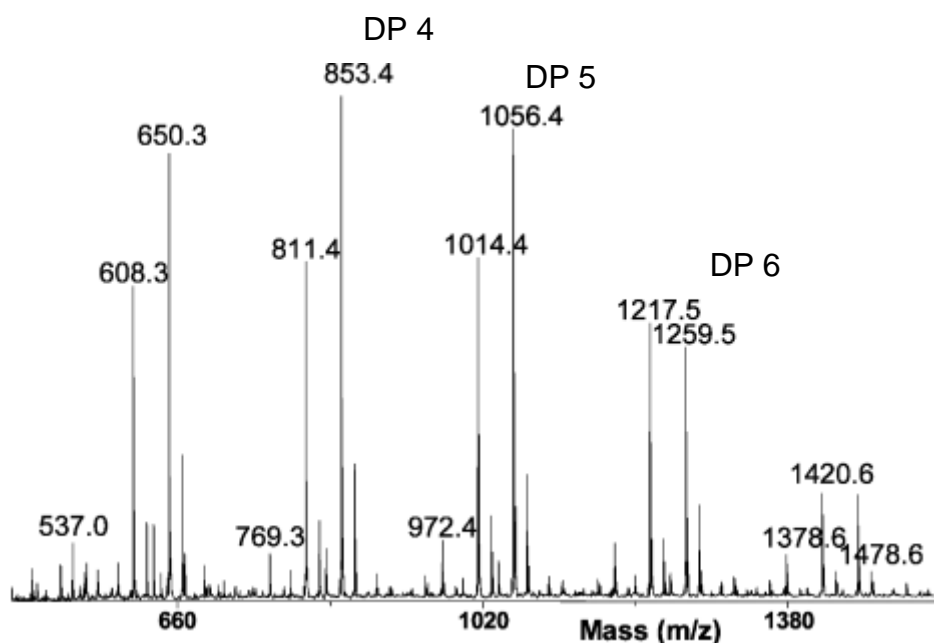

Figure 2-6. MALDI-TOF spectrum of the chitin oligomers with DA 90%. Reprinted with permission from Trombotto *et al.*⁴² Copyright 2008 American Chemical Society.

3.4 Crystallinity

Chitin has a highly ordered crystalline structure, and degrading into oligomers may reduce its crystallinity. Generally, the crystallinity of chitin and its oligomer can be evaluated using X-ray diffraction measurements. The peak intensity of chitin is recorded over the scattering range of 4.5° to 50° with scan steps of 0.02° at a speed of 4.0° min⁻¹.^{36,45} The crystallinity index (I_{CR}) is generally measured by a method, which uses a maximum intensity of 110 (I_{110}) and the intensity of amorphous halo contribution (I_{am}),^{36,45,55,85} as follows:

$$I_{CR} = ((I_{110} - I_{am}) / I_{110}) \times 100 \quad (7)$$

The crystallinity index provides an idea on the crystalline fraction in chitin and its derivatives. The chitin exposed to adjunct treatment may be susceptible to depolymerization with crystalline fractions reduced. The crystallinity of steam explosion and depressurization treated chitin were reduced from 88 to 73%. These treated chitin samples were hydrolyzed with chitinases, and produced higher amount of oligomers compared to untreated chitin.³⁸ The chitin that has been treated with a combination of supercritical water and mechano-chemical grinding exhibited higher reduction of I_{CR} from 91 to 26%.³⁵ Ilankovan et al.¹² reported that chitin chemically treated with phosphoric acid, sodium hydroxide and methanol showed more amorphous nature with lower intensities of the 110 reflection. The adjunct treatment seems to result in chitin with lower crystallinity, which is more amenable to enzyme action in order to produce oligomers.

3.5 Molecular weight

Molecular weight (M) of chitin oligomers can be expressed in various ways, such as weight-average (M_w), number-average (M_n), and viscosity-average (M_v) molecular weights. M_n and M_w represent the total weight of the oligomers molecules, i.e GlcNAc and GlcN, divided by the total number of its constituting molecules and a sum of the weight fraction of each type of molecules multiplied by its molecular weight, respectively.³⁵ M_v can be determined from Mark-Houwink equation:

$$[\eta] = k(M_v)^\alpha \quad (8)$$

where $[\eta]$ (cm³ g⁻¹) is the intrinsic viscosity of chitin measured by viscometer, k is 0.24 cm³ g⁻¹ and α is 0.69, where, both k and α are constant parameters of chitin.^{27,86}

Measurement of the molecular weight of chitin and its oligomers commonly can be done by gel permeation chromatography (GPC) or size exclusion chromatography (SEC), which is generally equipped with refractive index detector, a GPC (gel permeation chromatography) column, and a guard column.^{35,87-89} The relative mean molecular weight of the chitin is estimated by the Pullulan standard curve.³⁵ Prior to measurement, samples for GPC require microfiltration (with 0.45 μ m filters).^{13,90}

The molecular weight is a significant parameter for effective hydrolysis of chitin. Kurita *et al.*⁸¹ reported that the chitin molecular weight of 300 kDa was effective for enzymatic hydrolysis. It has already been mentioned that the adjunct treatments applied may reduce the molecular weight of chitin prior to hydrolysis. Dziril *et al.*³⁷ reported that the molecular weight of gamma-radiated chitin decreased to 60% when irradiated with 50

kGy, and it further decreased to 90% when the applied dose was 210 kGy. The application of supercritical water treatment combined with mechano-chemical grinding reduced the molecular weight of chitin from 800 kDa to 10 kDa.³⁵ Ramírez-Coutiño et al.³⁹ obtained the molecular weight of 343.5 kDa for α -chitin with 90% of solubility after treating it with alkali. This molecular weight decrease is mainly due to the glycoside bond breaking caused by the treatment of chitin.³⁷

On the other hand, the molecular weight of chitin oligomers produced by hydrolysis is lower than native chitin. Kazami et al.⁴⁵ reported that the number-average molecular weight of both α - and β -chitin rapidly decreased to 13 kDa and 10 kDa from 241 kDa and 90 kDa, respectively, after 15 min of hydrolysis in HCl. At the same time, the weight-average molecular weight of α - and β -chitin also reduced to approximately 16 kDa from 330 kDa and 250 kDa, respectively. Previous study reported that the chitin oligomers with molecular weight of 1 to 3 kDa was more effective as antioxidant agents those with molecular weight of 1 kDa and lower.³² Thus, the biological effect of chitin oligomers is significantly dependent on the molecular weight.⁹¹

3.6 Oligomers yield

Yield of the oligomers after hydrolysis is a significant parameter because it determines the economic viability of the process. The yield can be expressed simply as the percentage of the chitin hydrolysed as follows:

$$\% \text{ Yield} = \frac{W_1 - W_2}{W_1} \times 100 \quad (9)$$

where, W1 and W2 are the initial weight and weight of chitin after hydrolysis, respectively.^{31,40} The yields reported earlier for acidic hydrolysis of chitin lie between 10 and 21%.^{40,45} These values are comparable with enzymatic hydrolysis. Iankovan *et al.*¹² and Hongkulsup³¹ reported the yield of chitin oligomers hydrolysed by commercial enzymes were in a range of 10 to 13%. Although this is a low yield, it can be increased by modifying chitin structure prior to hydrolysis by employing some of the adjunct methods discussed in this paper.

High performance liquid chromatography (HPLC) is an efficient technique for quantification of the oligomers according to each DP.^{6,11,31} The amount of each DP (GlcNAc_n) can be estimated with the calibration curve, as shown in the following equation:

$$C1 = C2 \times (A1/A2) \quad (10)$$

where, C1 is the sample concentration (mg/mL), C2 is the standard concentration (mg/mL), A1 is the peak area of sample and A2 is the peak area of standard.⁶ Wang *et al.*⁶ found the yield of the GlcNAc₂, GlcNAc₃, GlcNAc₄ and GlcNAc₅ were 0.44 mg/mL, 0.08 mg/mL, 0.09 mg/mL and 0.43 mg/mL, respectively, after chitin depolymerizing under fermentation condition for two days. The results obtained show that the concentrations of GlcNAc₂ and GlcNAc₅ are significantly higher than GlcNAc₃ and GlcNAc₄. Unlike fermentation, the hydrolysis of chitin by commercial enzymes like hemicellulase and pectinase produce higher amounts of GlcNAc₃, GlcNAc₄ and GlcNAc₅ as reported by Hongkulsup³¹. In acid hydrolysis, higher acid concentration and temperature can influence the amount of chitin oligomers formed. The amount of GlcNAc₂, GlcNAc₃ and GlcNAc₅ apparently increased when the acid concentration

increased from 4 N to 7 N during hydrolysis at 70 °C.⁴⁰ The amount of GlcNAc₂ produced can be 30 times greater when the hydrolysis temperature is raised to 90 °C.⁴⁰

4. Antimicrobial properties of chitin derivatives and their oligomers

Chitin, chitosan and their derivatives, such as oligomers, have recently attracted great interest because of their potential application to inhibit microbial growth. With respect to antimicrobial activity, it is generally believed that chitosan is superior to chitin because it possesses a number of polycationic amines which interact with the negatively charged macromolecules present in the cell surface of bacteria.²⁷ However, chitin and chitosan oligomers, which are soluble in water, can also have effective antimicrobial properties compared to their native compounds.²⁷

There have been some studies reporting that the antimicrobial activity of chitin and chitosan oligomers against Gram-negative and Gram-positive bacteria depend on their molecular weight. No et al.⁹¹ observed that chitosan oligomers with molecular weight 1 kDa or greater, more effectively inhibited *E. coli* and *L. monocytogenes* when compared with the 22 kDa oligomers. Laokuldiluk et al.⁹⁶ have also noted that chitosan oligomers with lower molecular weight (5 kDa) show a greater inhibition towards *E. coli* and *S. typhimurium* than the higher molecular weight (14 and 41 kDa). Benhabiles et al.²⁷ also reported that chitin and chitosan oligomers with lower molecular weight than chitin and chitosan exhibited significant bactericidal effect against all the Gram-negative and Gram-positive strains tested. These authors speculated that such oligomers are able to pass through the bacterial cell wall and reach the plasma membrane.²⁷

In other studies, chitosan oligomers composed of a mixture of dimer, trimer, tetramer, pentamer and hexamer showed better inhibitory effect towards *B. cereus* and *E. coli* than the individual oligomers.⁹³ In fact, the growth inhibition of the tested strains treated with chitosan hexamer was higher than dimer, which shows that the inhibitory effect is not exclusively dependent on molecular weight, but also other factors such as the degree of polymerisation.⁹³ Moreover, the inhibition towards *E. coli* progressively increased with concentration, and from dimer to heptamer.⁹⁴

In addition, chitin and chitosan monomers have also been extensively studied as antimicrobial agents due to their wider application in the biomedical industry.⁹⁵ Raut et al.⁹⁵ reported that the growth of *E. coli* and *S. aureus* were completely inhibited within 5 h after treatment with 0.1 % GlcNAc. In contrast, no-growth activity was found on *E. coli* and *B. cereus* when 100 µg of GlcNAc was applied, while, chitosan monomer (GlcN) showed a marginally better inhibition by 5 to 10 %.⁹³ The antimicrobial activity of the GlcN has been reported to be caused by the binding of free $-NH_3^+$ groups with the negatives charges on the bacterial cell surface.⁹³ These authors also conclude that the monomers possessed greater antimicrobial activity against Gram-negative and Gram-positive compared to the water insoluble native chitin and chitosan.^{93,95}

In general, chitosan has been widely employed as antimicrobial coating on the food surface due to its availability and solubility in common solvents. Coating the food contact surface of packaging with antimicrobial agents allows a unique film to be formed, which can release the antimicrobial to inhibit pathogenic growth.⁹⁷ This enables chitosan coating to have a preserving effect on food and improve its shelf life of food.⁹⁷ Chitosan coating, either on its own or after incorporation with other antimicrobial agent, on the surface of fruits and vegetables, raw meat and seafood as well as ready-to-eat (RTE) food products

have been reported to inhibit inoculated pathogenic bacteria such as *E. coli*, *L. monocytogenes* and *Salmonella*.⁹⁸⁻¹⁰⁵ Contamination of fruits and vegetables by *E. coli* can occur through soil, irrigation water, wildlife and compost, whereas RTE food can be contaminated by *L. monocytogenes* either due to insufficient thermal processing, or due to post-processing handling methods employed, e.g. sharing the same area and utensils as the raw material or storage temperature abuse.^{101,106,107}

According to Guo et al.¹⁰¹ and Jovanović et al.^{103,104}, 1% (w/v) chitosan solution exhibited an inhibitory effect against *L. monocytogenes* inoculated on black radish and shredded cabbage as well as *E. coli* and *Salmonella* inoculated on the strawberries. These authors reported that the inoculated *L. monocytogenes* ATCC 19115 on black radish and shredded cabbage was completely inhibited by 1% chitosan in acetic acid solution after 24 h and 120 h of storage at 4 °C, respectively.^{103,104} In fact, the inhibitory effect of chitosan increased with the addition of acetic acid, which, on its own, is considered to be the most effective antimicrobial agent against *L. monocytogenes*.¹⁰³ Other studies also reported that 2% acetic acid used as a solvent enhanced the antimicrobial effects of chitosan against *L. monocytogenes* inoculated on the RTE shrimp, which caused a 5.38-log CFU/g count reduction after 16 days of storage.¹⁰⁰ In another related study, the inhibitory effect of water-soluble chitosan, also known as oligomers, coated on raw shrimp against *L. innocua* increased as the concentration increased.⁹⁸ In this case, the oligomers alone, without any added organic acid, was able to inhibit bacterial growth inoculated on the food surface. In conclusion, the antimicrobial properties of the chitosan and chitin oligomers can be exploited for developing antimicrobial coating on food and food-contact surfaces.

References

- 1 Feng F, Liu Y and Hu K, Influence of alkali-freezing treatment on the solid state structure of chitin. *Carbohydr Res* **339**: 2321-2324 (2004).
- 2 Jang MK, Kong BG, Jeong YI, Lee CH and Nah JW, Physicochemical characterization of α -chitin, β -chitin, and γ -chitin separated from natural resources. *J Polym Sci A Polym Chem* **42**: 3423-3432 (2004).
- 3 Arbia W, Arbia L, Adour L, and Amrane A, Chitin extraction from crustacean shells using biological methods - a review. *Food Technol Biotechnol*, **51**:12-25 (2013).
- 4 Jeon YJ, Shahidi F and Kim SK, Preparation of chitin and chitosan oligomers and their applications in physiological functional foods. *Food Rev Int* **16**: 159-176 (2000).
- 5 Gopalan NK and Dufresne A, Crab shells chitin whiskers reinforced natural rubber nanocomposites. 1. Processing and swelling behavior. *Biomacromolecules* **4**: 657-665 (2003).
- 6 Wang SL, Liu CP and Liang TW, Fermented and enzymatic production of chitin/chitosan oligosaccharides by extracellular chitinases from *Bacillus cereus* TKU027. *Carbohydr Polym* **90**: 1305-1313 (2012).
- 7 Kurita K, Chitin and chitosan: functional biopolymers from marine crustaceans. *Mar Biotechnol* **8**: 203-226 (2006).
- 8 Benhabiles MS, Abdi N, Drouiche N, Lounici H, Pauss A, Goosen MFA and Mameri N, Protein recovery by ultrafiltration during isolation of chitin from shrimp shells *Parapenaeus longirostris*. *Food Hydrocoll* **32**: 28-34 (2013).
- 9 Synowiecki J and Al-Khateeb NA, Production, properties, and some new applications of chitin and its derivatives. *Crit Rev Food Sci Nutr* **43**: 145-171 (2003).
- 10 Hirano S and Nagao N, An improved method for the preparation of colloidal chitin by using methanesulfonic acid. *Agric Biol Chem* **52**: 2111-2112 (1988).
- 11 Il'ina AV, Zueva OY, Lopatin SA and Varlamov VP, Enzymatic hydrolysis of α -chitin. *Appl Biochem Microbiol* **40**: 35-38 (2004).
- 12 Ilankovan P, Hein S, Ng CH, Trung TS and Stevens WF, Production of N-acetyl chitobiose from various chitin substrates using commercial enzymes. *Carbohydr Polym* **63**: 245-250 (2006).
- 13 Kubota N, Tatsumoto N, Sano T and Toya K, A simple preparation of half N-acetylated chitosan highly soluble in water and aqueous organic solvents. *Carbohydr Res* **324**: 268-274 (2000).
- 14 Rinaudo M, Chitin and chitosan: properties and applications. *Progr Polym Sci* **31**: 603-632 (2006).

- 15 Kumar MNR, A review of chitin and chitosan applications. *React Funct Polym* **46**: 1-27 (2000).
- 16 Suh JKF and Matthew HW, Application of chitosan-based polysaccharide biomaterials in cartilage tissue engineering: a review. *Biomater* **21**: 2589-2598 (2000).
- 17 Sogias IA, Khutoryanskiy VV and Williams AC, Exploring the factors affecting the solubility of chitosan in water. *Macromol Chem Phys* **211**: 426-433 (2010).
- 18 Huei CR and Hwa HD, Effect of molecular weight of chitosan with the same degree of deacetylation on the thermal, mechanical, and permeability properties of the prepared membrane. *Carbohydr Polym* **29**: 353-358 (1996).
- 19 Park SY, Marsh KS and Rhim JW, Characteristics of different molecular weight chitosan films affected by the type of organic solvents. *J Food Sci* **67**: 194-197 (2002).
- 20 Seyfarth F, Schliemann S, Elsner P and Hipler UC, Antifungal effect of high-and low-molecular-weight chitosan hydrochloride, carboxymethyl chitosan, chitosan oligosaccharide and N-acetyl-D-glucosamine against *Candida albicans*, *Candida krusei* and *Candida glabrata*. *Int J Pharm* **353**: 139-148 (2008).
- 21 Benhabiles MS, Drouiche N, Lounici H, Pauss A and Mameri N, Effect of shrimp chitosan coatings as affected by chitosan extraction processes on postharvest quality of strawberry. *J Food Meas Charact* **7**: 215-221 (2013).
- 22 Vila A, Sánchez A, Janes K, Behrens I, Kissel T, Jato JLV and Alonso MJ, Low molecular weight chitosan nanoparticles as new carriers for nasal vaccine delivery in mice. *Eur J Pharm Biopharm* **57**: 123-131 (2004).
- 23 Xing R, Liu S, Guo Z, Yu H, Wang P, Li C, Li Z and Li P, Relevance of molecular weight of chitosan and its derivatives and their antioxidant activities in vitro. *Bioorg Med Chem* **13**: 1573-1577 (2005).
- 24 Tsai GJ, Zhang SL and Shieh PL, (2004). Antimicrobial activity of a low-molecular-weight chitosan obtained from cellulase digestion of chitosan. *J Food Prot* **67**: 396-398 (2004).
- 25 Prashanth KVH and Tharanathan RN, Chitin/chitosan: modifications and their unlimited application potential – an overview. *Trends Food Sci Technol* **18**: 117-131 (2007).
- 26 Ahmed ABA, Taha RM, Mohajer S, Elaagib ME and Kim SK, Preparation, properties and biological applications of water soluble chitin oligosaccharides from marine organisms. *Russ J Mar Biol* **38**: 351-358 (2012).
- 27 Benhabiles MS, Salah R, Lounici H, Drouiche N, Goosen MFA and Mameri N, Antibacterial activity of chitin, chitosan and its oligomers prepared from shrimp shell waste. *Food Hydrocolloids* **29**: 48-56 (2012).
- 28 Alam J and Mathur A, Evaluation of antifungal potential of chitin and chitin-based derivatives against pathogenic fungal strains. *Int Q J Biol Life Sci* **2**: 1354-1358 (2014).

- 29 Liang TW, Chen YJ, Yen YH and Wang SL, The antitumor activity of the hydrolysates of chitinous materials hydrolyzed by crude enzyme from *Bacillus amyloliquefaciens* V656. *Process Biochem* **42**: 527-534 (2007).
- 30 Ngo DN, Kim MM and Kim SK, Chitin oligosaccharides inhibit oxidative stress in live cells. *Carbohydr Polym* **74**: 228-234 (2008).
- 31 Hongkulsup C, Enzyme assisted extraction of chitin from shrimp shells (*Litopenaeus vannamei*) and its application as an antimicrobial agent. PhD thesis, University of Reading, UK, (2016).
- 32 Ngo DN, Lee SH, Kim MM and Kim SK, Production of chitin oligosaccharides with different molecular weights and their antioxidant effect in RAW 264.7 cells. *J Funct Foods* **1**: 188-198 (2009).
- 33 Roy I, Mondal K and Gupta MN, Accelerating enzymatic hydrolysis of chitin by microwave pretreatment. *Biotechnol Prog* **19**: 1648-1653 (2003).
- 34 Ajavakom A, Supsvetson S, Somboot A and Sukwattanasinitt, Products from microwave and ultrasonic wave assisted acid hydrolysis of chitin. *Carbohydr Polym* **90**: 73-77 (2012).
- 35 Osada M, Miura C, Nakagawa YS, Kaihara M, Nikaido M and Totani K, Effects of supercritical water and mechanochemical grinding treatments on physicochemical properties of chitin. *Carbohydr polym* **92**: 1573-1578 (2013).
- 36 Villa-Lerma G, González-Márquez H, Gimeno M, López-Luna A, Bázquez E and Shirai K, Ultrasonication and steam-explosion as chitin pretreatments for chitin oligosaccharide production by chitinases of *Lecanicillium lecanii*. *Bioresour Technol* **146**: 794-798 (2013).
- 37 Dziril M, Grib H, Laribi-Habchi H, Drouiche N, Abdi N, Lounici H, Pauss A and Mameri N, Chitin oligomers and monomers production by coupling γ radiation and enzymatic hydrolysis. *J Ind Eng Chem* **26**: 396-401 (2015).
- 38 Villa-Lerma G, González-Márquez H, Gimeno M, Trombotto S, David L, Ifuku S and Shirai K, Enzymatic hydrolysis of chitin pretreated by rapid depressurization from supercritical 1, 1, 1, 2-tetrafluoroethane toward highly acetylated oligosaccharides. *Bioresour Technol* **209**: 180-186 (2016).
- 39 Ramírez-Coutiño L, del Carmen Marín-Cervantes M, Huerta S, Revah S and Shirai K, Enzymatic hydrolysis of chitin in the production of oligosaccharides using *Lecanicillium fungicola* chitinases. *Process Biochem* **41**: 1106-1110 (2006).
- 40 Chang KLB, Lee J and Fu WR, HPLC analysis of N-acetyl-chito-oligosaccharides during the acid hydrolysis of chitin. *J Food Drug Anal* **8**: 75-83 (2000).
- 41 Einbu A and Vårum KM, Depolymerization and de-N-acetylation of chitin oligomers in hydrochloric acid. *Biomacromolecules* **8**: 309-314 (2007).

- 42 Trombotto S, Ladavière C, Delolme F and Domard A, Chemical preparation and structural characterization of a homogeneous series of chitin/chitosan oligomers. *Biomacromolecules* **9**: 1731-1738 (2008).
- 43 Einbu A and Vårum KM, Characterization of chitin and its hydrolysis to GlcNAc and GlcN. *Biomacromolecules* **9**: 1870-1875 (2008).
- 44 Einbu A, Grasdalen H and Vårum KM, Kinetics of hydrolysis of chitin/chitosan oligomers in concentrated hydrochloric acid. *Carbohydr Res* **342**: 1055-1062 (2007).
- 45 Kazami N, Sakaguchi M, Mizutani D, Masuda T, Wakita S, Oyama F, Kawakita M and Sugahara Y, A simple procedure for preparing chitin oligomers through acetone precipitation after hydrolysis in concentrated hydrochloric acid. *Carbohydr Polym* **132**: 304-310 (2015).
- 46 Moerschbacher BM and El Gueddari NE, Bio-activity matrices for partially acetylated chitosan oligomers, *Proc. ICCO-EUCHIS2006 Montpellier, France*, ed. Domard A, Guibal E and Vårum KM, *Advances in Chitin Science* (as CD Rom), pp 10-23 (2007).
- 47 Purushotham P, Sarma PVS RN and Podile AR, Multiple chitinases of an endophytic *Serratia proteamaculans* 568 generate chitin oligomers. *Bioresour Technol* **112**: 261-269 (2012).
- 48 Eva-Lena HULT, Katouno F, Uchiyama T, Watanabe T and Sugiyama J, Molecular directionality in crystalline β -chitin: hydrolysis by chitinases A and B from *Serratia marcescens* 2170. *Biochem J* **388**: 851-856 (2005).
- 49 Hamer SN, Cord-Landwehr S, Biarnés X, Planas A, Waegeman H, Moerschbacher BM and Kolkenbrock S, Enzymatic production of defined chitosan oligomers with a specific pattern of acetylation using a combination of chitin oligosaccharide deacetylases. *Sci Rep* **5**: 8716.
- 50 Terwisscha van Scheltinga AC, Armand S, Kalk KH, Isogai A, Henrissat B and Dijkstra BW, Stereochemistry of chitin hydrolysis by a plant chitinase/lysozyme and x-ray structure of a complex with allosamidin evidence for substrate assisted catalysis. *Biochem* **34**: 15619-15623 (1995).
- 51 Roy I, Sardar M and Gupta MN, Hydrolysis of chitin by PectinexTM. *Enzyme Microb Technol* **32**: 582-588 (2003).
- 52 Das S, Sen R and Roy D, Enzymatic processing of chitinaceous wastes for N-acetyl-d-glucosamine production: an example of green and efficient environmental management. *Environ Eng Manag J* **11**: 1849-1855 (2012).
- 53 Machová E, Kvapilova K, Kogan G and Šandula J, Effect of ultrasonic treatment on the molecular weight of carboxymethylated chitin–glucan complex from *Aspergillus niger*. *Ultrason Sonochem* **5**: 169-172 (1999).
- 54 Takahashi Y, Miki F and Nagase K, Effect of sonolysis on acid degradation of chitin to form oligosaccharides. *Bull Chem Soc Jpn* **68**: 1851-1857 (1995).

- 55 Kjartansson GT, Zivanovic S, Kristbergsson K and Weiss J, Sonication-assisted extraction of chitin from shells of fresh water prawns (*Macrobrachium rosenbergii*). *J Agric Food Chem* **54**: 3317-3323 (2006).
- 56 Wu HS, Lin BC and Sitanggang AB, Process for producing glucosamine and acetyl glucosamine by microwave technique. US Patent 20110114472 A1 (2011).
- 57 Choi WS, Ahn KJ, Lee DW, Byun MW and Park HJ, Preparation of chitosan oligomers by irradiation. *Polym Degrad Stab* **78**: 533-538 (2002).
- 58 Hai L, Diep TB, Nagasawa N, Yoshii F and Kume T, Radiation depolymerization of chitosan to prepare oligomers. *Nucl Instrum Methods Phys Res Sect B* **208**: 466-470 (2003).
- 59 Kang B, Dai YD, Zhang HQ and Chen D, Synergetic degradation of chitosan with gamma radiation and hydrogen peroxide. *Polym Degrad Stab* **92**: 359-362 (2007).
- 60 Oliveira FM, Pinheiro IO, Souto-Maior AM, Martin C, Gonçalves AR and Rocha GJ, Industrial-scale steam explosion pretreatment of sugarcane straw for enzymatic hydrolysis of cellulose for production of second generation ethanol and value-added products. *Bioresour Technol* **130**: 168-173 (2013).
- 61 Alvira P, Negro MJ, Ballesteros I, González A and Ballesteros M, Steam explosion for wheat straw pretreatment for sugars production. *Bioethanol* **2**: 66-75 (2016).
- 62 Savage PE, Organic chemical reactions in supercritical water. *Chem Rev* **99**: 603-622 (1999).
- 63 Zaluski L, Zaluska A and Ström-Olsen JO, Hydrogenation properties of complex alkali metal hydrides fabricated by mechano-chemical synthesis. *J Alloys Compd* **290**: 71-78 (1999).
- 64 Osada M, Miura C, Nakagawa YS, Kaihara M, Nikaido M and Totani K, Effect of sub-and supercritical water pretreatment on enzymatic degradation of chitin. *Carbohydr Polym* **88**: 308-312 (2012).
- 65 Cho YW, Jang J, Park C R and Ko SW, Preparation and solubility in acid and water of partially deacetylated chitins. *Biomacromolecules* **1**: 609-614 (2000).
- 66 Kurita K, Controlled functionalization of the polysaccharide chitin. *Prog Polym Sci* **26**: 1921-1971 (2001).
- 67 Kasaai MR, A review of several reported procedures to determine the degree of N-acetylation for chitin and chitosan using infrared spectroscopy. *Carbohydr Polym* **71**: 497-508 (2008).
- 68 Duarte ML, Ferreira MC, Marvao MR and Rocha J, An optimised method to determine the degree of acetylation of chitin and chitosan by FTIR spectroscopy. *Int J Biol Macromol* **31**: 1-8 (2002).

- 69 Stuart BH, Experimental methods, in *Infrared Spectroscopy: Fundamentals and Applications*, ed by Stuart BH, John Wiley & Sons Ltd, Chichester, UK, pp 76-77 (2004).
- 70 Van de Velde K and Kiekens P, Structure analysis and degree of substitution of chitin, chitosan and dibutrylchitin by FT-IR spectroscopy and solid state ^{13}C NMR. *Carbohydr Polym* **58**: 409-416 (2004).
- 71 Brugnerotto J, Lizardi J, Goycoolea FM, Argüelles-Monal W, Desbrieres J and Rinaudo M, An infrared investigation in relation with chitin and chitosan characterization. *Polym* **42**: 3569-3580 (2001).
- 72 Knight JA, Smoak MP, Porter RA and Kirkland WE, Direct pressing of fibers for infrared spectroscopic studies. *Text Res J* **37**: 924-927 (1967).
- 73 Kaya M, Sargin I, Tozak KÖ, Baran T, Erdogan S and Sezen G, Chitin extraction and characterization from *Daphnia magna* resting eggs. *Int J Biol Macromol* **61**: 459-464 (2013).
- 74 Al Sagheer FA, Al-Sughayer MA, Muslim S and Elsabee MZ, Extraction and characterization of chitin and chitosan from marine sources in Arabian Gulf. *Carbohydr Polym* **77**: 410-419 (2009).
- 75 Kaya M, Baran T, Menten A, Asaroglu M, Sezen G and Tozak KO, Extraction and characterization of α -chitin and chitosan from six different aquatic invertebrates. *Food Biophys* **9**: 145-157 (2014).
- 76 Beil S, Schamberger A, Naumann W, Machill S and van Pée KH, Determination of the degree of N-acetylation (DA) of chitin and chitosan in the presence of water by first derivative ATR FTIR spectroscopy. *Carbohydr Polym* **87**: 117-122 (2012).
- 77 Wu T and Zivanovic S, Determination of the degree of acetylation (DA) of chitin and chitosan by an improved first derivative UV method. *Carbohydr Polym* **73**: 248-253 (2008).
- 78 Baxter A, Dillon M, Taylor KA and Roberts GA, Improved method for IR determination of the degree of N-acetylation of chitosan. *Int J Biol Macromol* **14**: 166-169 (1992).
- 79 Ottey MH, Vårum KM and Smidsrød O, Compositional heterogeneity of heterogeneously deacetylated chitosans. *Carbohydr Polym* **29**: 17-24 (1996).
- 80 Hongkulsup C, Khutoryanskiy VV and Niranjan K, Enzyme assisted extraction of chitin from shrimp shells (*Litopenaeus vannamei*). *J Chem Technol Biotechnol* **91**: 1250-1256 (2016).
- 81 Kurita K, Kaji Y, Mori T and Nishiyama Y, Enzymatic degradation of β -chitin: susceptibility and the influence of deacetylation. *Carbohydr Polym* **42**: 19-21 (2000).
- 82 Cabrera JC and Van Cutsem P, Preparation of chitooligosaccharides with degree of polymerization higher than 6 by acid or enzymatic degradation of chitosan. *Biochem Eng J* **25**: 165-172 (2005).

- 83 Li J, Du Y, Yang J, Feng T, Li A and Chen P, Preparation and characterisation of low molecular weight chitosan and chito-oligomers by a commercial enzyme. *Polym Degrad Stab* **87**: 441-448 (2005).
- 84 Nars A, Rey T, Lafitte C, Vergnes S, Amatya S, Jacquet C, Dumas B, Thibaudeau C, Heux L, Bottin A and Fliegmann J, An experimental system to study responses of *Medicago truncatula* roots to chitin oligomers of high degree of polymerization and other microbial elicitors. *Plant cell Rep* **32**: 489-502 (2013).
- 85 Salaberria AM, Fernandes SC, Diaz RH and Labidi J, Processing of α -chitin nanofibers by dynamic high pressure homogenization: characterization and antifungal activity against *A. niger*. *Carbohydr polym* **116**: 286-291 (2015).
- 86 Mirzadeh H, Yaghobi N, Amanpour S, Ahmadi H, Mohagheghi M A and Hormozi F, Preparation of chitosan derived from shrimp's shell of Persian Gulf as a blood hemostasis agent. *Iran Polym J* **11**: 63-68 (2002).
- 87 Teng WL, Khor E, Tan TK, Lim LY and Tan SC, Concurrent production of chitin from shrimp shells and fungi. *Carbohydr Res* **332**: 305-316 (2001).
- 88 Qin CQ, Du YM and Xiao L, Effect of hydrogen peroxide treatment on the molecular weight and structure of chitosan. *Polym Degrad Stab* **76**: 211-218 (2002).
- 89 Yen MT, Yang JH and Mau JL, Physicochemical characterization of chitin and chitosan from crab shells. *Carbohydr Polym* **75**: 15-21 (2009).
- 90 Kasaai MR, Arul J and Charlet G, Intrinsic viscosity–molecular weight relationship for chitosan. *J Polym Sci Part B: Polym Phys* **38**: 2591-2598 (2000).
- 91 No HK, Park NY, Lee SH and Meyers SP, Antibacterial activity of chitosans and chitosan oligomers with different molecular weights. *Int J Food Microbiol* **74**: 65-72 (2002).
- 92 Salah R, Michaud P, Mati F, Harrat Z, Lounici H, Abdi N, Drouiche N, Mameri N, Anticancer activity of chemically prepared shrimp low molecular weight chitin evaluation with the human monocyte leukaemia cell line, THP-1. *Int J Biol Macromol* **52**:333–339 (2013).
93. Kumar ABV, Varadaraj MC, Gowda LR, Tharanathan RN, Characterization of chito-oligosaccharides prepared by chitosanolytic with the aid of papain and Pronase, and their bactericidal action against *Bacillus cereus* and *Escherichia coli*. *Biochem J* **391**:167-175 (2005).
94. Jeon YJ, Kim SK, Production of chitoooligosaccharides using an ultrafiltration membrane reactor and their antibacterial activity. *Carbohydr Polym* **41**:133-41 (2000).
95. Raut AV, Satvekar RK, Rohiwal SS, Tiwari AP, Gnanamani A, Pushpavanam S, Nanaware SG, Pawar SH, In vitro biocompatibility and antimicrobial activity of chitin monomer obtain from hollow fiber membrane. *Des Monomers Polym* **19**:445-55 (2016).
96. Laokuldilok T, Potivas T, Kanha N, Surawang S, Seesuriyachan P, Wangtueai S, Phimolsiripol Y, Regenstein JM, Physicochemical, antioxidant, and antimicrobial

properties of chitooligosaccharides produced using three different enzyme treatments. *Food Biosci* **18**:28-33 (2017).

97. Jin TZ, Antimicrobial packaging in combination with nonthermal processing, in *Packaging for Nonthermal Processing of Food*, ed by Malvin AP, Jung HH. Wiley-Blackwell, pp 43-62 (2018)

98. Alfaro L, Chotiko A, Chouljenko A, Janes M, King JM, Sathivel S, Development of water-soluble chitosan powder and its antimicrobial effect against inoculated *Listeria innocua* NRRL B-33016 on shrimp. *Food control* **85**:453-458 (2013).

99. Guo M, Jin TZ, Scullen OJ, Sommers CH, Effects of antimicrobial coatings and cryogenic freezing on survival and growth of *Listeria innocua* on frozen ready-to-eat shrimp during thawing. *J Food Sci* **78**:1195-200 (2013).

100. Li M, Wang W, Fang W, Li Y, Inhibitory effects of chitosan coating combined with organic acids on *Listeria monocytogenes* in refrigerated ready-to-eat shrimps. *J Food Prot* **76**:1377-1383 (2013).

101. Guo M, Jin TZ, Gurtler JB, Fan X, Yadav MP, Inactivation of *Escherichia coli* O157: H7 and *Salmonella* and native microbiota on fresh strawberries by antimicrobial washing and coating. *J Food Prot* **81**:1227-1235 (2018).

102. Benabbou R, Subirade M, Desbiens M, Fliss I, The impact of chitosan-divergicin film on growth of *Listeria monocytogenes* in cold-smoked salmon. *Front Microbiol* **9**:2824 (2018).

103. Jovanović GD, Klaus AS, Nikšić MP, Antimicrobial activity of chitosan coatings and films against *Listeria monocytogenes* on black radish. *Rev Argent Microbiol* **48**:128-136 (2016).

104. Jovanović GD, Klaus AS, Nikšić MP, Antimicrobial activity of chitosan films with essential oils against *Listeria monocytogenes* on cabbage. *Jundishapur J Microbiol* **9**(9):e34804 (2016).

105. Serio A, Chaves-López C, Sacchetti G, Rossi C, Paparella A, Chitosan coating inhibits the growth of *Listeria monocytogenes* and extends the shelf life of vacuum-packed pork loins at 4° C. *Foods* **7**(10):155 (2018).

106. Buchanan RL, Microbiological criteria for cooked, ready-to-eat shrimp and crabmeat. *Food Technol* **45**:157–160 (1991).

107. Rutherford TJ, Marshall DL, Andrews LS, Coggins PC, Schilling MW, Gerard P, Combined effect of packaging atmosphere and storage temperature on growth of *Listeria monocytogenes* on ready-to-eat shrimp. *Food Microbiol* **24**:703–710 (2007).

Chapter 3 : Enzymatic hydrolysis of thermally pre-treated chitin and antimicrobial activity of *N,N'*-diacetylchitobiose

(Published as “Abidin MZ, Kourmentza C, Karatzas K, Niranjana K, Enzymatic hydrolysis of thermally pre-treated chitin and antimicrobial activity of *N,N'*-diacetylchitobiose. *J Chem Technol Biotechnol* **94**: 2529-2536 (2019)”)

Abstract

N,N'-diacetylchitobiose (GlcNAc₂) is known to be highly functional and offers a wide range of applications, especially as an antimicrobial agent. In this study, a thermal pre-treatment process using steam under pressure in an autoclave, has been employed to facilitate subsequent enzymatic hydrolysis of chitin with chitinase from *Streptomyces griseus*. Pre-treatment of chitin with 0.05 M sodium acetate buffer (pH=6.0) at 121 °C for 60 min, followed by enzymatic hydrolysis involving 24 h incubation, was found to be the best condition for producing the GlcNAc₂. The GlcNAc₂ obtained was tested regarding its antimicrobial activity against Gram-negative and Gram-positive strains and showed minimum inhibitory concentrations (MIC) at 5 and 10% w/v against *Escherichia coli* K-12 and *Listeria monocytogenes* 10403S, respectively. The extent of swelling and crystallite size of chitin increased with the pre-treatment residence time, and enhanced the rate of subsequent hydrolysis using chitinase.

1. Introduction

Chitin is a polymer consisting of *N*-acetyl-D-glucosamine (GlcNAc) monomeric units that form covalent β-(1→4)-linkages and is the second most abundant polysaccharide in

nature after cellulose. It is a dominant component of the cell walls in most fungi, crustaceans and insect exoskeletons, and offers a wide range of structural and protection functionality.¹ *N,N'*-diacetylchitobiose (GlcNAc₂) is an oligomer composed of two GlcNAc units, which can be produced by the acidic or enzymatic hydrolysis of chitin. The oligomers, that are composed of approximately ten or less GlcNAc residues, have received considerable attention because they offer excellent solubility in water, nontoxicity, biocompatibility and numerous biological properties such as antimicrobial and antitumor activities.^{1,2} It has also been reported previously that the oligomers inhibit the growth of Gram-positive (*B. cereus*, *L. monocytogenes* and *S. aureus*) and Gram-negative bacteria (*B. fragilis*, *E. coli*, *P. aeruginosa*, *P. melaninogenica*, *Shigella dysenteriae* and *V. cholera*) more effectively than chitin and chitosan.³⁻⁵

Hydrolysis of chitin, using either acid or enzyme, is normally restricted due to its highly crystalline structure caused by the strong dipole–dipole interactions between polysaccharide chains.³ Several chitin pre-treatment methods, such as gamma irradiation, grinding, microwave irradiation, steam explosion, supercritical water and ultrasonication, have been proposed to assist the hydrolysis.¹ These pre-treatment methods have been reported to reduce the chitin crystallinity, particle size and molecular weight, as well as increase the crystallite size and extent of deacetylation. In addition to such physical pre-treatment, the use of ionic liquid as solvent has been studied in polysaccharides for removing their native recalcitrant such as cellulose and lignocellulose.^{6,7} Ionic liquids have also been used for chitin pre-treatment, which is reported to have induced greater enzyme accessibility to the substrate during hydrolysis with chitinases.^{8,9} It is interesting to note that the pre-treatments reported so far are fairly complex and difficult to scale up. To date, the effectiveness of simple autoclaving as a pre-treatment process has not been

explored. Therefore, the aim of this study was to investigate the effectiveness of thermal pre-treatment of chitin under autoclaving conditions (121 °C, 204.7 kPa) in order to assist the production of GlcNAc₂ by enzymatic hydrolysis, and assess the antimicrobial activity of the product against Gram-negative and Gram-positive organisms.

2. Materials and methods

Commercial chitin from shrimp shells (practical grade powder) and chitinase from *Streptomyces griseus* were obtained from Sigma Aldrich, UK. Gram-negative bacterium *Escherichia coli* K-12 and Gram-positive bacterium *Listeria monocytogenes* 10403S were cultivated in-house (Department of Food and Nutritional Sciences, University of Reading, UK). The chitin was sieved through a 125 µm sieve to produce particles in the narrow size range of less than 125 µm and was stored in opaque plastic bottles at ambient temperature until further use. All other reagents used in this study were of analytical grade and commercially available.

2.1 Pre-treatment of chitin

One percent w/v chitin in 0.05 M sodium acetate buffer at pH 6.0 was thermally pre-treated in an autoclave (Priorclave, UK) at 121 °C (204.7 kPa) for time durations ranging between 15 and 60 min. Immediately after pre-treatment, the sample was rapidly cooled under running tap water, and separated into an aqueous solution and a non-soluble solid fraction by centrifugation (Centaur 2, MSE Sussex, UK) at 5000 rpm for 15 min.¹⁰ The solid fraction was thoroughly washed with distilled water and then left to dry at 60 °C for 10 h. The aqueous solution was stored at 4 °C prior to analysis.¹¹

2.2 Characterization of chitin

2.2.1 Reducing sugars

The amount of reducing sugars produced during pre-treatment in the aqueous solution were determined by the dinitrosalicylic acid (DNS) method. The DNS reagent was prepared by mixing 10 g of DNS powder with 300 g of sodium potassium tartrate (Rochelle salt) and 2 N NaOH in 800 mL of distilled water. The mixture was gently heated to dissolve the solids, and the volume was made up to 1 L with distilled water. This method was proposed by Saqib and Whitney¹² but the concentrations of NaOH solutions used in this work were different. Prior to the analysis, the sample was prepared by mixing the aqueous solution with distilled water and DNS reagent at a ratio of 1:1:3 and boiled in a water bath for 10 min.¹¹ After boiling, the sample was allowed to cool under running tap water. Colour formation was determined by measuring absorbance against blank at a wavelength of 530 nm through UV-Vis spectrophotometer (Cecil CE 7400, Cambridge, UK). The defined absorbance value of the sample was converted to the amount of reducing sugars produced during the reaction using a GlcNAc standard curve.

2.2.2 Crystallinity index (I_{CR}) and crystallite size (nm)

Crystallinity of the dried pre-treated chitin was determined by X-ray powder diffraction (Bruker D8 Advance, Karlsruhe, Germany) with an incident radiation CuK α and $\lambda = 1.5418 \text{ \AA}$ in the range of $2\theta = 4.5\text{-}50$ with steps of 0.02° (CAF, University of Reading, UK). The method described was identical to the one reported by Villa-Lerma et al.¹³

Crystallinity index (I_{CR}) is a quantitative indicator of the crystalline fraction in the chitin material.^{14,15} I_{CR} of the samples was determined using intensities of the peaks at [1 1 0] around $2\theta = 20^\circ$ (corresponding to the maximal intensity, I_{110}) and at $2\theta = 16^\circ$ (amorphous diffraction, I_{am}).^{2,13}

$$I_{CR} (\%) = \left(\frac{I_{110} - I_{am}}{I_{110}} \right) \times 100 \quad (1)$$

Crystallite size (nm) of the chitin at [1 1 0] lattice was calculated using the Scherrer equation.

$$L = \frac{0.9\lambda}{(H \cos \theta)} \quad (2)$$

where L is the crystallite size perpendicular to the plane; H is the full-width at half-maximum of the deflection peak; and θ is the Bragg's angle.

2.2.3 CP/MAS ^{13}C -NMR spectroscopy

Structure of the pre-treated solid chitin was determined using carbon nuclear magnetic resonance (^{13}C -NMR) spectroscopy with an AV500 two-channel NMR instrument (Bruker Advance III 500 MHz, Germany) operating at Larmor frequency of 125.77 MHz with the use of 4 mm MAS probe spun at 10 kHz rate (CAF, University of Reading, UK). The spectra were obtained over 1024 number of scans with 10 s relaxation delays at ambient temperature. The CP contact time was 2.0 ms, and the 90° pulse width was 3.7 μs at a power level of 38 W. All spectra were referenced to external adamantane signal

as a secondary reference (frequency peak at 38.5 ppm with respect to tetramethylsilane (TMS)).

2.3 Enzymatic hydrolysis of pre-treated chitin

Enzymatic hydrolysis was conducted by mixing the pre-treated chitin solution, i.e. 1.0% (w/v) chitin in 0.05 M sodium acetate buffer at pH 6.0, with 0.1% (w/v) of enzyme chitinase from *Streptomyces griseus* (Sigma Aldrich, UK). The reaction mixture was incubated in a shaker water bath at 40 °C for different time intervals. The reaction was stopped by boiling for 10 min to denature the chitinase and centrifuged (Centaur 2, MSE Sussex, UK) for 15 min at 5000 rpm. The supernatant was collected and filtered with 0.22 µm pore size of PVDF membrane syringe filter and stored at 4 °C for HPLC analysis.² The filtrate was lyophilized (Virtis, UK) and stored at -20 °C until further use.

2.4 GlcNAc₂ composition

The GlcNAc₂ composition was determined using high pressure liquid chromatography by an Agilent 1100 Series HPLC System (Agilent Technologies, Italy) equipped with a UV detector, at a wavelength 205 nm. The product was identified through a Nucleosil® NH₂ HPLC column, with 5 µm particle size (L × I.D. 25 cm × 4.6 mm), using 70% acetonitrile and 30% ultra-pure water as the mobile phase, at a flow rate of 1.0 mL/min at 50 °C. A calibration curve was constructed by measuring the peak area of standard GlcNAc₂ (Sigma Aldrich, UK). The concentration of the GlcNAc₂ in the enzymatic reaction mixture was estimated by comparison with the calibration standard, and the yield was calculated by the following equation.^{2,16}

$$\text{Product yield (\%)} = \frac{\text{Weight of GlcNAc}_2 \text{ produced}}{\text{Weight of chitin used}} \times 100 \quad (3)$$

Mass spectrum of the GlcNAc₂ was obtained by liquid chromatography-mass spectrometry (LC-MS) using a Thermo Scientific Accela HPLC system coupled with a Thermo Scientific LTQ Orbitrap XL mass spectrometer. The mass spectrum (m/z) of GlcNAc₂ was theoretically calculated by the following equation:¹⁷

$$\text{Mass spectrum (m/z)} = ([\text{DP} \times \text{C}_8\text{H}_{13}\text{O}_5\text{N}] + \text{H}_2\text{O}) + \text{adduct ions} \quad (4)$$

where DP is the degree of polymerisation, C₈H₁₃O₅N is the chitin molecular weight, H₂O is the water molecule attached to the GlcNAc₂ after hydrolysis and Na⁺ or H⁺ the cationised adduct ions transferred from the solvent (0.1% formic acid in 30% water and 70% acetonitrile).

2.5 Antimicrobial activity determination

The antimicrobial activity of GlcNAc₂ was evaluated following the broth microdilution methodology as described previously.¹⁸ Antibacterial susceptibility tests were performed against the Gram-negative bacterium *E. coli* K-12 and Gram-positive bacteria *L. monocytogenes* 10403S. The minimum inhibitory concentration (MIC) was defined as the lowest concentration of GlcNAc₂, in which bacteria were not able to grow after 24 h of incubation.¹⁹

E. coli and *L. monocytogenes* were grown on Tryptic Soy (TS) and Brain Heart Infusion (BHI) agar respectively, at 37 °C for 24 h. Agar plates were then stored at 4 °C for up to 3 weeks prior to use. For the bacterial suspension preparation, 2-3 colonies were picked

from each agar plate using a sterile plastic loop. Colonies of *E. coli* and *L. monocytogenes* were transferred to sterile Mueller Hinton (MH) and Tryptic Soy (TS) broth respectively and incubated at 37 °C for 16-18 h. The optical density (OD) of the suspension was then adjusted to 0.5 McFarland using a UV-Vis spectrophotometer (Orion AquaMate 8000, Thermo Scientific, UK) at 620 nm, which corresponds to approximately 1.5×10^8 CFU/mL. Then, the suspensions were diluted to give a final colony count of 1.5×10^5 CFU/mL and used as inoculum for the determination of the MIC determination in the presence of GlcNAc₂.

GlcNAc₂ was dissolved in the respective growth medium (MHB or TSB), and the maximum concentration tested was 10% w/v. Two-fold dilutions were performed and 100 µL of each dilution were placed in each column of a flat bottomed 96-well plate (Cellstar, Greiner bio-one Ltd., UK). Column 11 of the 96-well plate contained only the growth medium and, upon inoculation, served as a growth control while column 12 contained 200 µL of the GlcNAc₂ tested at its maximum concentration (10% w/v) and served as a sterility control. In all columns, apart from column 12, 100 µL of each bacterial suspension were added and 96-well plates were incubated at 37 °C for 24 h. The optical density of the cultures was assessed at 620 nm (OD_{620nm}) after 24 hours using a FLUOstar Omega multi-detection microplate reader (BMG Labtech, UK) in order to detect the MIC for each case. All experiments were performed in triplicate.

2.6 Statistical analysis

Minitab® 18 (USA) statistical software was used for analysis of the difference in means by Tukey's multiple range test. The results were determined by one-way analysis of variance (ANOVA) at a significance level of 0.05 ($P < 0.05$). The pre-treatment was

undertaken in duplicate and each replication was run for analysis of crystallite size, crystallinity index, reducing sugar contents and GlcNAc₂ yield. The experiments on antimicrobial activity were run in triplicate regardless of pre-treatment replication due to the lyophilisation of GlcNAc₂ from the hydrolysate that accumulated after hydrolysis.

3. Results and discussions

3.1 Effect of thermal pre-treatment on chitin

The crystallite size is referred to as the size of individual crystal of lattice [1 1 0] inside a chitin particle. The changes in crystallite size of the chitin after pre-treatment is shown in Figure 3-1. It is evident that the crystallite size did not significantly change when the chitin was exposed to the pre-treatment between 15 and 45 min. The crystallite size of the control, and that after 60 min of pre-treatment, were not significantly different from the chitin that underwent pre-treatment for 15 to 45 min. However, after 60 min of exposure to the pre-treatment, the crystallite size changed significantly ($P < 0.05$) from 7 nm (control sample) to 9 nm. This increase may be attributed to swelling of the chitin during autoclaving. This observation is consistent with an earlier study which showed that crystallite size increased by almost 30 to 40% when chitin was pre-treated between 300 and 400 °C for times up to 5 min.^{2,20} These authors reported that the crystallite size increased with autoclaving time initially, but then went through a turning point. They also noted that chitin swelling occurred due to increased spacing of the [1 1 0] planes of the individual cell lattice.²

The crystallinity index (I_{CR}) was used to quantify the relative amount of crystalline material in chitin.²¹ The I_{CR} of chitin, reported in Table 3-1, shows no significant

differences between control and various pre-treated samples. The absence of decrystallisation suggests that the chitin structure survives 60 min of autoclaving. In a previous study, by Osada et al.²⁰, it has been reported that the decrystallisation of the crystalline region did not occur even at higher temperature between 180 and 400 °C unless the chitin was subjected to mechanical grinding and the I_{CR} was reduced to 27%. Nishino et al.²² also reported that the molecular chain of α -chitin was mechanically stable against heating at 150 °C.

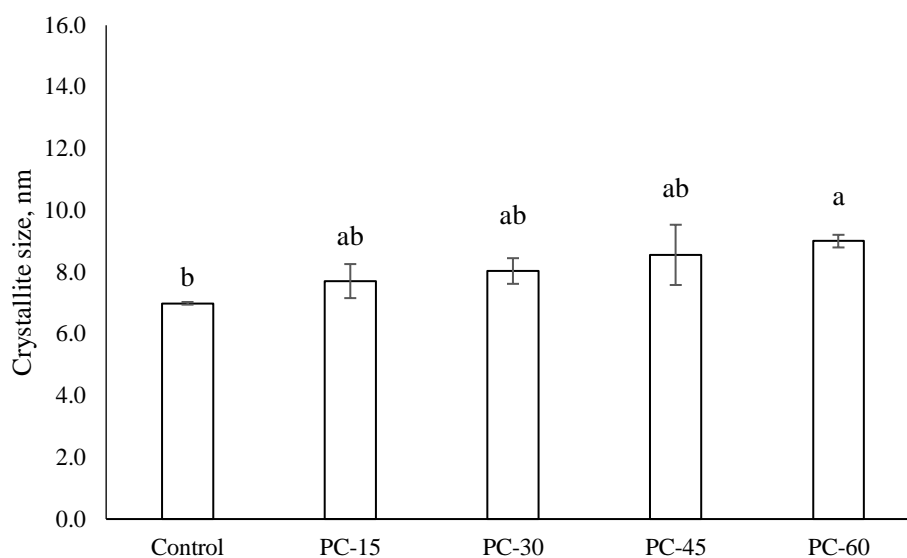

Figure 3-1. Crystallite size (nm) of chitin in sodium acetate buffer (pH 6.0) after autoclaving at 121 °C for time durations between 15 and 60 min. Control represents non-autoclaved chitin in the same solution. Different letters above each bar indicate significant differences ($P<0.05$) between pre-treatment conditions.

Table 3-1. Effect of autoclaving chitin at 121 °C (204.7 kPa) for various times on the reducing sugar content and crystallinity index (I_{CR}).

| Sample | Time (min) | Reducing sugars (mg/mL) | I_{CR} (%) |
|---------|------------|-------------------------|--------------|
| Control | - | ND* | 74.534 a |
| PC-15 | 15 | 0.005 b** | 75.394 a |
| PC-30 | 30 | 0.003 b | 73.933 a |
| PC-45 | 45 | 0.006 b | 74.182 a |
| PC-60 | 60 | 0.010 a | 74.894 a |

*ND, not detected

** Different letters in each column indicate significant differences ($P<0.05$) among pre-treatment conditions

The reducing sugar content of chitin aqueous solution seems to increase very marginally after pre-treatment at 121 °C between 15 and 60 min as shown in Table 3-1. No reducing sugar was detected in the starting sample. This suggests that the pre-treated aqueous solution may contain some partially degraded chitin polymers. The oligomers (GlcNAc₁₋₁₀) were not detected in the aqueous solution by HPLC (data not shown), indicating that the chitin degraded to some extent due to the action of free aldehyde group at reducing end (carbon C1) accepting hydrogen atoms from the water molecule during pre-treatment.^{23,24} Villa-Lerma et al.¹³ observed that the highest reducing sugar contents of chitin in the water was detected after 1 h exposure to the steam explosion at 240 °C. In addition to steam explosion, there are a few studies on chitin pre-treatment that employed high temperatures between 180 and 400 °C and have concluded that these methods could lead to partial hydrolysis of chitin.^{2,13,20,25}

Solid state ¹³CP/MAS NMR shown in Figure 3-2 was performed in order to observe the changes occurring in chitin structure during pre-treatment. There are eight signals for eight carbon atoms of *N*-acetyl-*D*-glucosamine residue observed between 20 and 110 ppm which correspond to C1-C6, C=O and CH₃. The spectra shows that the samples possess high structural homogeneity as the peaks C1 (104 ppm), C2 (55.1 ppm), C3 (73.4 ppm), C4 (83.2 ppm), C5 (75.6 ppm) and C6 (60.8 ppm), which remain unchanged with autoclaving. On the other hand, the C=O and CH₃ peaks at 173.6 and 22.6 ppm respectively, were less pronounced above 15 min of autoclaving, which shows enhanced deacetylation while transforming to chitosan. It has been reported previously that, the higher the deacetylation, the lower the intensity of C=O and CH₃ peaks due to removal of the acetyl group.^{26,27} Kasai²⁷ reported that the peaks of carbonyl and methyl groups of the chitin obtained by ¹³CP/MAS NMR became less pronounced as the degree of

acetylation (DA) decreased from 1.0 to 0.58. According to Villa-Lerma et al.²⁵, pre-treatment with steam explosion at 180 °C for 8 min was sufficient to decrease the degree of acetylation of the chitin from 98 to 92%. Furthermore, it has been reported that the use of elevated temperature and pressure also enhanced deacetylation as these conditions promote acidic hydrolysis by the formation of acetic acid from acetyl groups.^{13,28}

In this present study, the pre-treatment time employed has been limited to 60 min in order to avoid significant formation of chitosan by deacetylation, which can potentially lower the yield of GlcNAc₂ after hydrolysis.

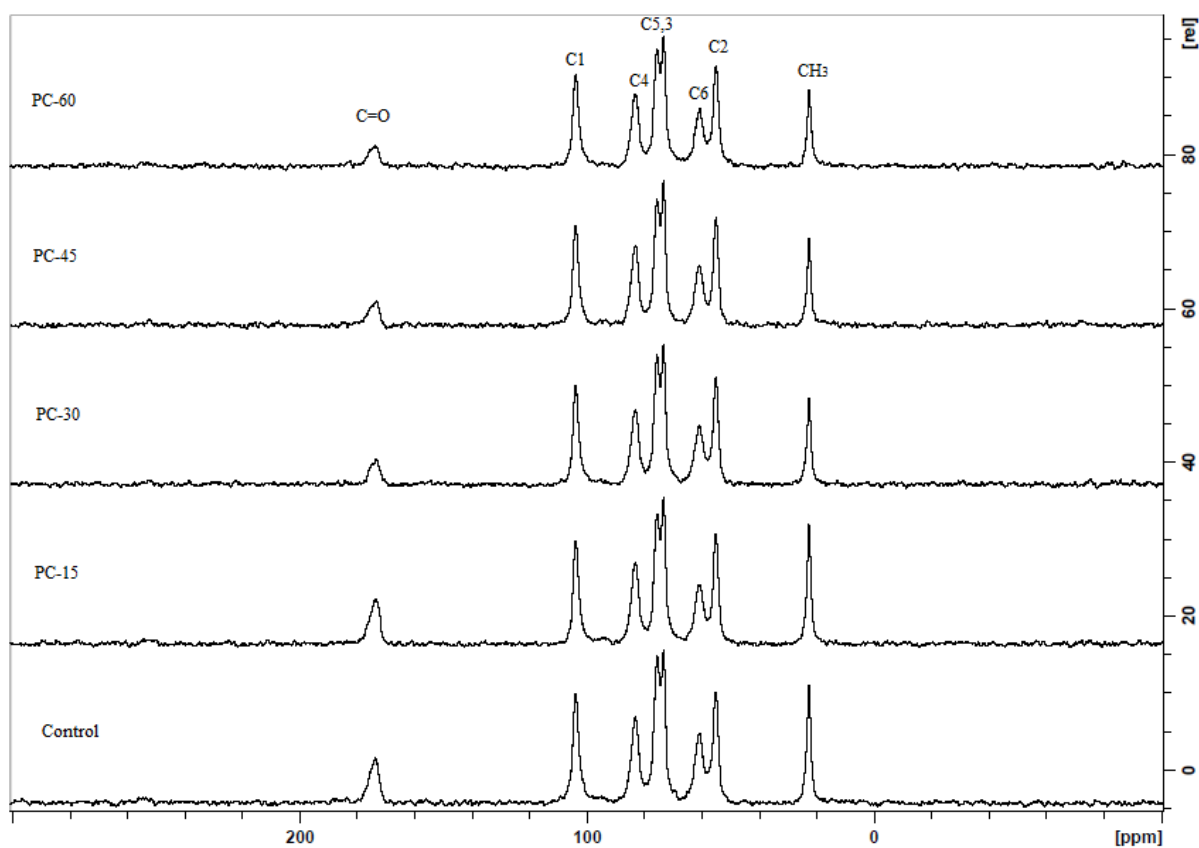

Figure 3-2. ¹³CP/MAS NMR spectra of control and thermal pre-treated chitin in sodium acetate buffer with pH 6.0 at 121 °C between 15 and 60 min.

3.2 Enzymatic hydrolysis of chitin

Enzymatic hydrolysis of chitin, with chitinase from *Streptomyces griseus*, mainly produced GlcNAc₂ and a relatively small amount of GlcNAc which is shown in Figure 3-5. Given the relatively small concentrations of the monomer, further discussion and indeed figures will only focus on the GlcNAc₂ levels as this compound is the dominant product of hydrolysis. As shown in Figure 3-3, the HPLC chromatogram of the standard GlcNAc₂ was comparable with the hydrolysate sample obtained by 24 h hydrolysis at 40 °C of the chitin autoclaved for 60 mins (i.e. PC-60 referred earlier). The retention time of the standard GlcNAc₂, as well as the sample obtained in this work, corresponded to the peak visible after 4.2 min. The chromatogram of the chitin hydrolysate detected by HPLC was also confirmed by the LC/MS mass spectra shown in Figure 3-4. The GlcNAc₂ spectrum detected at m/z 425.17 and 447.15 corresponds to the chitin dimer cationised by proton (H⁺) and sodium (Na), respectively. Moreover, the spectrum shows that the GlcNAc (222.09 m/z) and GlcNAc₂ were the only compounds detected in the hydrolysate of the chitin pre-treatment PC-60, and the absence of the higher oligomers. These results are consistent with an earlier study by Osada et al.², who employed a similar chitinase, i.e from *Streptomyces griseus*, to hydrolyse chitin into monomer and dimer of GlcNAc. Thus, the present, and indeed previous studies, suggest that the hydrolysis occurred by the following steps: (1) random cleaving to form the intermediate oligomers, i.e trimer (GlcNAc₃) and tetramer (GlcNAc₄) and (b) breaking down of the intermediate oligomers into GlcNAc and GlcNAc₂.²⁹

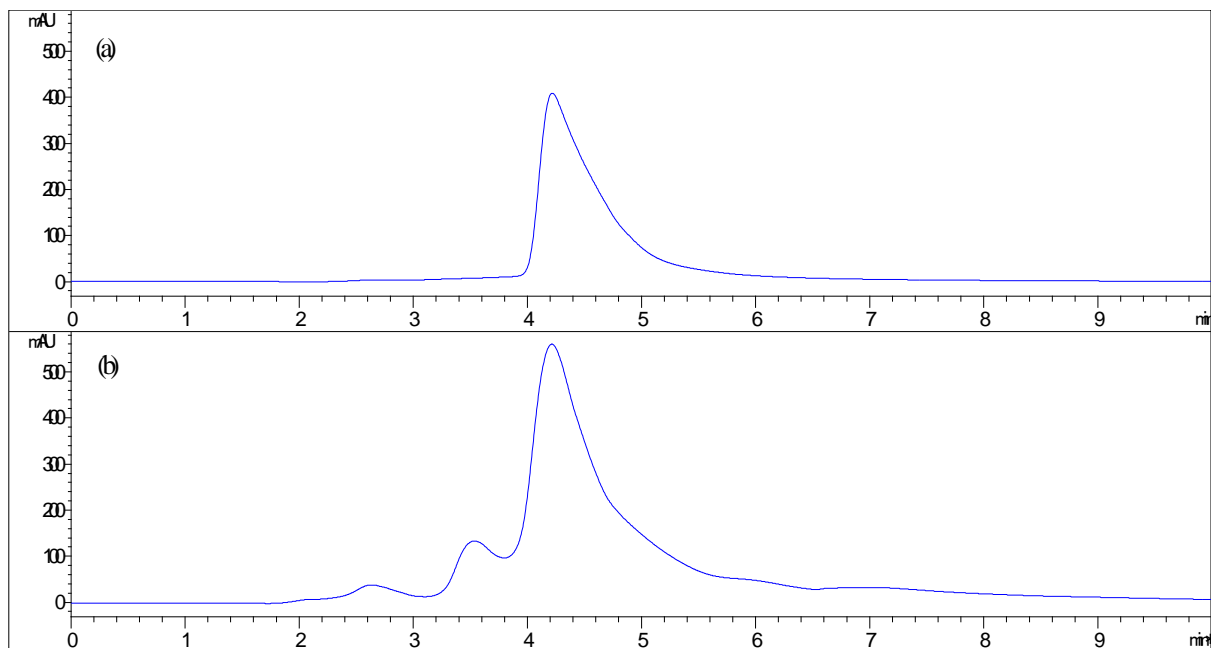

Figure 3-3. HPLC chromatography of (a) standard GlcNAc₂ and (b) sample GlcNAc₂ obtained in this study (i.e. hydrolysate obtained by reacting pre-treated chitin sample, i.e. PC-60, with chitinase from *Streptomyces griseus* at 40 °C for 24 h).

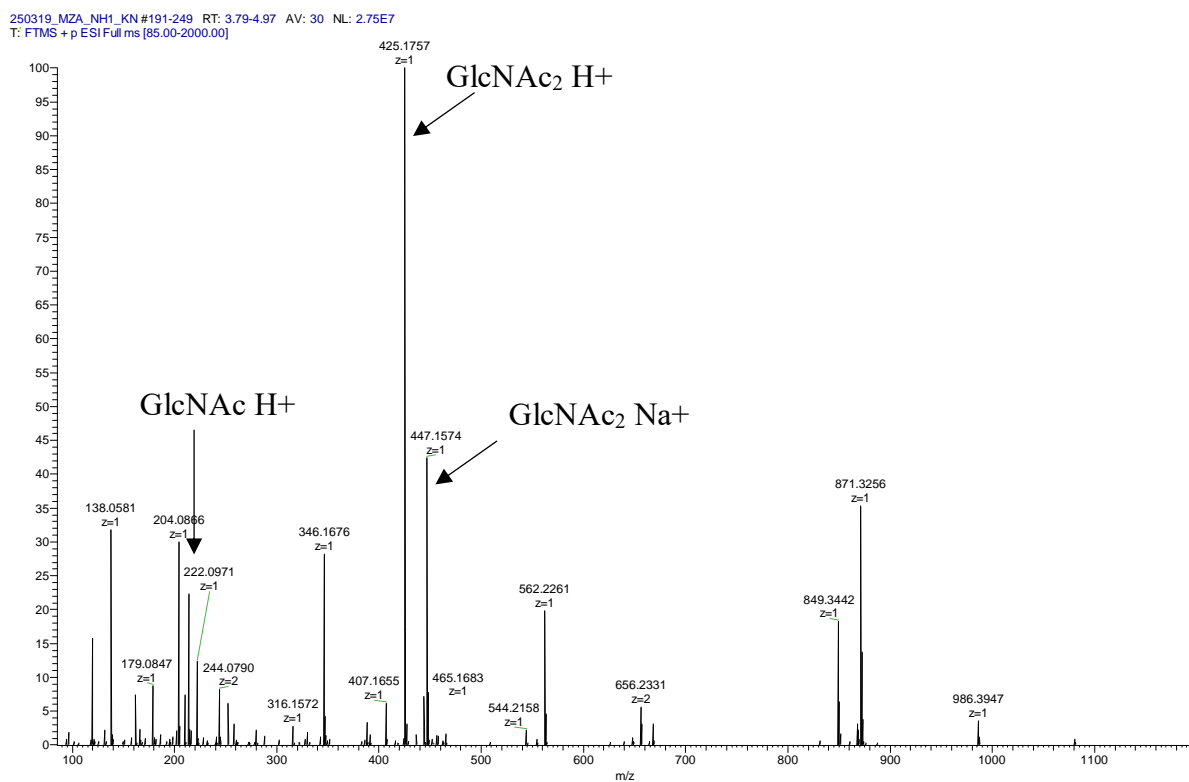

Figure 3-4. Mass spectra obtained by LC/MS of the hydrolysate formed from PC-60 after hydrolysis at 40 °C for 24 h by chitinase obtained from *Streptomyces griseus*.

The concentration of GlcNAc and GlcNAc₂ obtained by the hydrolysis of the control and PC-60 pre-treated chitins were monitored between 12 and 48 h by HPLC. Figure 3-5 shows that the concentration of GlcNAc₂ in the hydrolysate obtained from PC-60 reached a maximum value after 24 h, whereas the concentration in the hydrolysate obtained from the control sample reached similar values after 36 h. The higher hydrolysis rate observed in the case of the pre-treated chitin may be attributed to the partial degradation and swelling of the chitin caused during pre-treatment, which also accelerates enzyme reaction. Osada et al.² also reported swelling of chitin pre-treated at 400 °C for 1 min which resulted in a significantly higher formation of GlcNAc₂ after hydrolysis. Thus, thermal pre-treatment involving autoclaving in steam at a pressure of 204.7 kPa at 121 °C for 60 min, accelerated chitin hydrolysis with its crystalline structure preserved.

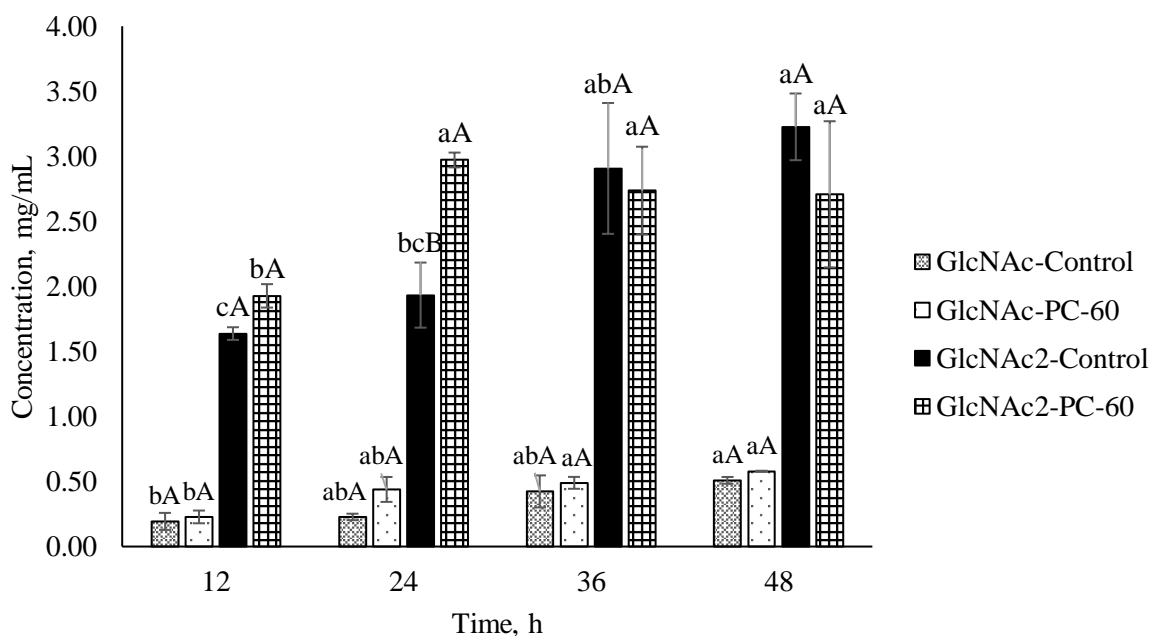

Figure 3-5. Time course of enzymatic hydrolysis of pre-treated (PC-60) and untreated (control) chitin with chitinase from *Streptomyces griseus* at 40 °C. Different small and capital letters indicate significant differences ($P < 0.05$) between incubation time (h) and pre-treatment conditions, respectively.

3.3 Effect of GlcNAc₂ on antimicrobial properties

Growth of *E. coli* and *L. monocytogenes* were significantly inhibited by the presence of GlcNAc₂ as shown in Figure 3-6 and Figure 3-7, respectively. The growth of these bacteria was found to be completely inhibited with the addition of 5% and 10% w/v of GlcNAc₂ respectively, which represent their respective MIC.

The inhibitory effect on Gram-negative and Gram-positive bacteria seems to increase with the concentration of GlcNAc₂. It has to be noted here that there has been only one study that reported the antimicrobial activity of the chitin dimer GlcNAc₂, compared to studies performed on the mixture of chitin and chitosan oligomers.³⁰ For example, molecules composed of dimer to hexamer (GlcNAc—GlcN)₂₋₆, which have molecular weights greater than monomer and dimer, are more likely to exert antimicrobial activity.^{5,30-32} Benhabiles et al.³ and Raut et al.⁴ found that *E. coli* was completely inhibited when treated with 0.1% (w/v) chitin and chitosan oligomers as well as chitin monomer. Low molecular weight chitosan oligomers have also been reported to effectively inhibit the bacteria.³³ No et al.³³ observed that 1.0% (w/v) of 1 kDa chitosan oligomers were more effective in inhibiting Gram-negative bacteria, including *E. coli*, compared to higher molecular weight oligomers. Benhabiles et al.³ also reported that the chitin and chitosan oligomers possess higher antibacterial activity with the MIC values being much lower than their native compounds. However, it has been argued by Kittur et al.⁵ that the chitosan monomer, GlcN, has lower antimicrobial activity than its hexamer, GlcN₆. This indicates that the antimicrobial activity of the oligomers is dependent on their molecular weight. The higher the molecular weight of the oligomers, the greater its antimicrobial activity in the case of Gram-negative bacteria.

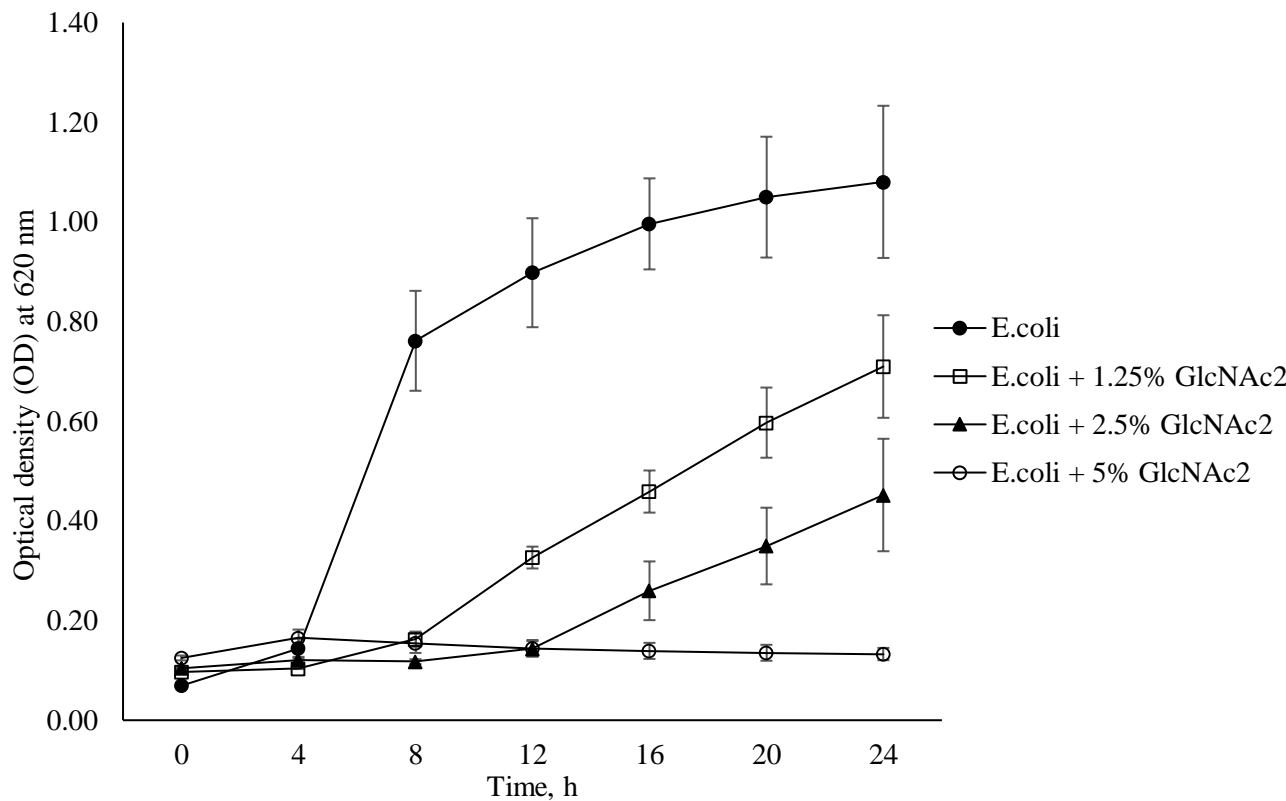

Figure 3-6. Effect of GlcNAc₂ on the growth of *E.coli* at 37 °C for 24 h.

Studies on the inhibitory effect of the chitin against *L. monocytogenes* are very limited because of its functionality on the chitinolytic system. This bacteria possesses two chitinases, ChiA and ChiB, which can convert the chitin oligomers into monomers.^{34,35} Chitosan has been reported to be more active than its oligomers in inhibiting *L. monocytogenes* Scott A, having an MIC at 0.1% (w/v) in the presence of acetic acid after 24 h of incubation.³³ In that study, 1% acetic acid had been used as the chitosan solvent and was proven effective in inhibiting the growth of several Gram-negative and Gram-positive bacteria, apart from lactic acid bacteria that were more effectively suppressed when 1% lactic or formic acid was used. Chitin and chitosan are insoluble in water, therefore, strong inorganic and organic acids respectively, are required to dissolve these compounds.^{3,4,33} According to Bjarnsholt et al.³⁶, 0.5% acetic acid in AB minimal medium resulted in a pH equal to 4.33 that led to complete killing *Pseudomonas*

aeruginosa PAO1. It was also revealed that the pH had a significant influence on the effectiveness of acetic acid as an antimicrobial agent.

In the present study, the mechanism of bacterial inactivation may be attributable either to (1) its ability to bind to and weaken the barrier function of the cell wall, followed by the destruction of the cell membrane; or to (2) the deposition of the GlcNAc₂ on the cell wall thereby blocking the flow of nutrients into the cell.^{5,37,38} In addition, the MIC of the GlcNAc₂ against both Gram-negative and Gram-positive bacteria obtained in the present study cannot be directly compared to previously reported studies, in terms of the antibacterial activity of chitin and its derivatives, due to the variations between the degree of polymerisation, degree of acetylation and the presence of other functional group.³²

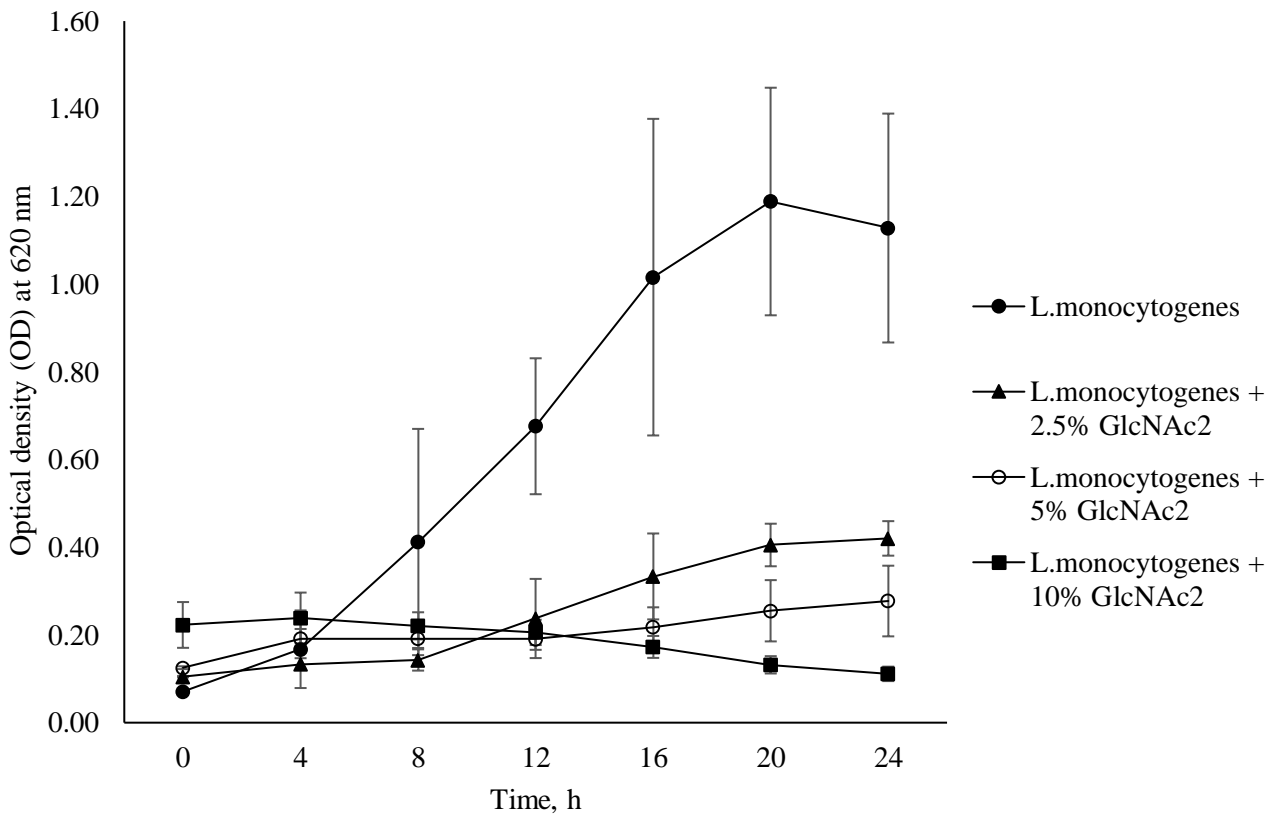

Figure 3-7. Effect of GlcNAc₂ on the growth of *L. monocytogenes* at 37 °C for 24 h.

4. Conclusion

In this study, the accessibility limitation of the β -glycosidic bonds in the crystalline chitin for enzymatic reactions was overcome by employing thermal pre-treatment in an autoclave prior to hydrolysis with chitinase from *Streptomyces griseus*. Pre-treatment of chitin at 121 °C for 60 min was found to be effective for substrate modification prior to enzymatic hydrolysis. The crystallite size of chitin increased and deacetylation occurred as the pre-treatment residence time increased. The hydrolysis of pre-treated chitin with chitinase was completed within 24 h, showing that the proposed condition for pre-treatment accelerated the enzymatic reaction. The dominant GlcNAc₂ produced has advantages regarding its application as an antimicrobial agent since it is more readily soluble in water. The GlcNAc₂ produced in this study exhibited strong antimicrobial activity against *E. coli* and *L. monocytogenes*, showing MIC values of 5 and 10% w/v, respectively.

References

1. Abidin MZ, Junqueira-Gonçalves MP, Khutoryanskiy VV., Niranjana K. Intensifying chitin hydrolysis by adjunct treatments – an overview. *J Chem Technol Biotechnol* **92**:2787–2798 (2017).
2. Osada M, Miura C, Nakagawa YS, Kaihara M, Nikaido M, Totani K, Effect of sub- and supercritical water pretreatment on enzymatic degradation of chitin. *Carbohydr Polym* **88**:308–312 (2012).
3. Benhabiles MS, Salah R, Lounici H, Drouiche N, Goosen MFA, Mameri N, Antibacterial activity of chitin, chitosan and its oligomers prepared from shrimp shell waste. *Food Hydrocoll* **29**:48–56 (2012).
4. Raut AV, Satvekar RK, Rohiwal SS, Tiwari AP, Gnanamani A, Pushpavanam S, Nanaware SG, Pawar SH, In vitro biocompatibility and antimicrobial activity of chitin monomer obtain from hollow fiber membrane. *Des Monomers Polym* **19**:445–455 (2016).
5. Kittur FS, Vishu Kumar AB, Varadaraj MC, Tharanathan RN, Chitoooligosaccharides - Preparation with the aid of pectinase isozyme from *Aspergillus niger* and their antibacterial activity. *Carbohydr Res* **340**:1239–1245 (2005).
6. Ling Z, Chen S, Zhang X, Takabe K, Xu F, Unraveling variations of crystalline cellulose induced by ionic liquid and their effects on enzymatic hydrolysis. *Sci Rep* **7**:1–11 (2017).
7. Zhang Z, Zhao ZK, Solid acid and microwave-assisted hydrolysis of cellulose in ionic liquid. *Carbohydr Res* **344**:2069–2072 (2009).
8. Husson E, Hadad C, Huet G, Laclef S, Lesur D, Lambertyn V, Jamali A, Gottis S, Sarazin C, Nguyen Van Nhien A, The effect of room temperature ionic liquids on the selective biocatalytic hydrolysis of chitin via sequential or simultaneously strategies. *Green Chem.* Royal Society of Chemistry; **19**:4122–4131 (2017).
9. Berton P, Shamshina JL, Rogers RD, Ostadjoo S, King CA, Enzymatic hydrolysis of ionic liquid-extracted chitin. *Carbohydr Polym* [Internet]. Elsevier; **199**:228–2235 (2018).
10. No HK, Nah JW, Meyers SP, Effect of time/temperature treatment parameters on depolymerization of chitosan. *J Appl Polym Sci* **87**:1890–1894 (2003).
11. Das S, Sen R, Roy D, Enzymatic processing of chitinaceous wastes for N-acetyl-D-glucosamine production: An example of green and efficient environmental management. *Environ Eng Manag J* **11**:1849–1855 (2012).
12. Saqib AAN, Whitney PJ, Differential behaviour of the dinitrosalicylic acid (DNS) reagent towards mono- and di-saccharide sugars. *Biomass Bioenerg* **35**:4748–4750 (2011).
13. Villa-Lerma G, González-Márquez H, Gimeno M, Trombotto S, David L, Ifuku S, Shirai K, Enzymatic hydrolysis of chitin pretreated by rapid depressurization from

supercritical 1,1,1,2-tetrafluoroethane toward highly acetylated oligosaccharides. *Bioresour Technol* **209**:180–186 (2016).

14. Sa Y, Guo Y, Feng X, Wang M, Li P, Gao Y, Yang X, Jiang T, Are different crystallinity-index-calculating methods of hydroxyapatite efficient and consistent? *New J Chem* **41**:5723–5731 (2017).

15. Ioelovich M, Crystallinity and hydrophilicity of chitin and chitosan. *J Chem* **3**:7–14 (2014).

16. Liao H, Tzeng H, Chen S, Yen Y, Hospital MM, Science L, Preparation of chito oligosaccharides from chitin hydrolyzates with anti-leukemia activity, in *Asian Pacific Confederation of Chemical Engineering Congress*, The Society of Chemical Engineers, Japan, pp 800 (2004).

17. Trombotto S, Ladavière C, Delolme F, Domard A, Chemical preparation and structural characterization of a homogeneous series of chitin / chitosan oligomers. *Biomacromolecules* **9**:1731–1738 (2008).

18. Qaiyumi S, Macro- and microdilution methods of antimicrobial susceptibility testing, in *Antimicrobial Susceptibility Testing Protocols*, ed by Schwalbe R, Steele-Moore L, Goodwin A. CRC Press, Taylor & Francis Group, pp 75-81 (2007).

19. Andrews JM, Determination of minimum inhibitory concentrations. *J Antimicrob Chemother* **48**:5–16 (2001).

20. Osada M, Miura C, Nakagawa YS, Kaihara M, Nikaido M, Totani K, Effects of supercritical water and mechanochemical grinding treatments on physicochemical properties of chitin. *Carbohydr Polym* **92**:1573–1578 (2013).

21. Park S, Baker JO, Himmel ME, Parilla PA, Johnson DK, Cellulose crystallinity index: Measurement techniques and their impact on interpreting cellulase performance. *Biotechnol Biofuels* **3**:1–10 (2010).

22. Nishino T, Matsui R, Nakamae K, Elastic modulus of the crystalline regions of chitin and chitosan. *J Polym Sci Part B Polym Phys* **37**:1191–1196 (1999).

23. Kunz T, Lee EJ, Schiwek V, Seewald T, Methner FJ, Glucose – A reducing sugar? Reducing properties of sugars in beverages and food. *Brew Sci* **64**:61–67 (2011).

24. Roy I, Mondal K, Gupta MN, Accelerating enzymatic hydrolysis of chitin by microwave pretreatment. *Biotechnol Prog* **19**:1648–1653 (2003).

25. Villa-lerma G, González-márquez H, Gimeno M, López-luna A, Bárzana E, Shirai K, Ultrasonication and steam-explosion as chitin pretreatments for chitin oligosaccharide production by chitinases of *Lecanicillium lecanii*. *Bioresour Technol* **146**:794–798 (2013).

26. Younes I, Hajji S, Frachet V, Rinaudo M, Jellouli K, Nasri M, Chitin extraction from shrimp shell using enzymatic treatment. Antitumor, antioxidant and antimicrobial activities of chitosan. *Int J Biol Macromol* **69**:489–498 (2014).

27. Kasai MR, Determination of the degree of N-acetylation for chitin and chitosan by various NMR spectroscopy techniques: A review. *Carbohydr Polym* **79**:801–810 (2010).
28. Alvira P, Tomás-Pejó E, Ballesteros M, Negro MJ, Pretreatment technologies for an efficient bioethanol production process based on enzymatic hydrolysis: A review. *Bioresour Technol* **101**:4851–4861 (2010).
29. Berger L, Reynold DM, The chitinase system of a strain of *Streptomyces Griseus*. *Biochim Biophys Acta* **29**:522–534 (1958).
30. Kumar ABV, Varadaraj MC, Gowda LR, Tharanathan RN, Characterization of chito-oligosaccharides prepared by chitosan analysis with the aid of papain and Pronase, and their bactericidal action against *Bacillus cereus* and *Escherichia coli*. *Biochem J* **175**:167–175 (2005).
31. Jeon Y, Kim S, Production of chitooligosaccharides using an ultrafiltration membrane reactor and their antibacterial activity. *Carbohydr Polym* **41**:133–141 (2000).
32. Jeon Y, Park P, Kim S, Antimicrobial effect of chitooligosaccharides produced by bioreactor. *Carbohydr Polym* **44**:71–76 (2001).
33. No HK, Park NY, Lee SH, Meyers SP, Antibacterial activity of chitosans and chitosan oligomers with different molecular weights. *Int J Food Microbiol* **74**:65–72 (2002).
34. Paspaliari DK, Loose JSM, Larsen MH, Vaaje-Kolstad G, *Listeria monocytogenes* has a functional chitinolytic system and an active lytic polysaccharide monoxygenase. *FEBS J* **282**:921–936 (2015).
35. Leisner JJ, Larsen MH, Jørgensen RL, Brøndsted L, Thomsen LE, Ingmer H, Chitin hydrolysis by *Listeria* spp., including *L. monocytogenes*. *Appl Environ Microbiol* **74**:3823–3830 (2008).
36. Bjarnsholt T, Alhede M, Jensen PØ, Nielsen AK, Johansen HK, Homøe P, Høiby N, Givskov M, Kirketerp-Møller K, Antibiofilm properties of acetic acid. *Adv Wound Care* **4**:363–372 (2015).
37. Chung YC, Chen CY, Antibacterial characteristics and activity of acid-soluble chitosan. *Bioresour Technol* **99**:2806–2814 (2008).
38. Helander IM, Nurmiäho-Lassila EL, Ahvenainen R, Rhoades J, Roller S, Chitosan disrupts the barrier properties of the outer membrane of Gram-negative bacteria. *Int J Food Microbiol* **71**:235–244 (2001).

Chapter 4 : The effectiveness of *N,N'*-diacetylchitobiose (GlcNAc₂) as antimicrobial coating against *Listeria monocytogenes* on ready-to-eat shrimp

Preface to Chapter 4

In this chapter, GlcNAc₂ which has been shown to possess antimicrobial activity against food pathogenic strains (as reported in Chapter 3) has been assessed for its effectiveness as an antimicrobial coating on a real food system. Ready-to-eat shrimps were coated with 1% (w/v) GlcNAc₂, and the growth of *L. monocytogenes* as well as changes in the physicochemical properties of the shrimps during storage were monitored.

Abstract

N,N'-diacetylchitobiose, also known as GlcNAc₂, is reported to possess antimicrobial activity against pathogenic bacteria. In this study, 1% (w/v) GlcNAc₂ solution was applied on ready-to-eat (RTE) shrimp as an antimicrobial coating against *Listeria monocytogenes* during storage at 4 °C for 16 days. Texture properties, colour, TBARS values, moisture content and bacterial counts were monitored every four days and analysed. The results indicated that the GlcNAc₂ coating retarded the changes in texture properties, TBARS values and moisture content of the RTE shrimp during storage. The presence of GlcNAc₂ showed no significant changes on the RTE shrimp colour in comparison with the control. However, the growth of *L. monocytogenes* inoculated on the GlcNAc₂-coated RTE shrimp was slower than the control sample with the highest log reduction observed being 0.5 log CFU/mL. This study shows that the GlcNAc₂ used as an antimicrobial coating is able to reduce the bacterial counts and maintain the quality of the RTE shrimp during refrigerated storage.

1. Introduction

Ready-to-eat (RTE) shrimp (cooked) is a street food, and is retailed either in chilled or frozen form, more often than not, unpackaged in tropical countries.^{1,2} Consumer demand for this product has steadily grown over the years.¹ RTE shrimp requires minimum thermal processing (normally heated for 2 to 5 min, to temperatures above 63 °C at the centre of the shrimp meat) prior to consumption, which generally inactivates vegetative cells of bacteria that are pathogenic to humans.^{3,4} However, the chances of contamination by pathogenic bacteria, such as *Listeria monocytogenes*, cannot be ruled out, either due to insufficient thermal processing, or due to post-processing contamination, caused by sharing the same area and utensils as the raw shrimp, or due to temperature abuse during storage.^{3,5} In order to ensure safety and extend the shelf life and keeping quality of RTE shrimp, it is essential to introduce post-processing intervention to inhibit the growth of *L. monocytogenes* in the product.

Various methods have been proposed to control post-process contamination of RTE products by *L. monocytogenes*. The growth of *L. monocytogenes* on the RTE shrimp has been successfully inhibited by employing antimicrobial coatings such as spice and herb extracts and using films made from chitosan.^{1,6,7} The pathogenic growth has also been inhibited by employing thermal and non-thermal treatment and storing the product within modified atmosphere packaging at appropriate temperature.⁸⁻¹¹ Some earlier studies reported a significant growth of *L. monocytogenes* inoculated on the RTE shrimp stored at 4 °C. However, pathogenic growth was significantly inhibited by introducing an antimicrobial coating, e.g. a solution of chitosan coating 1-2% (w/v), which reduced their counts by approximately 2 log CFU/g compared to non-coated samples.^{6,7} Chitosan incorporated with spice and herb extracts as well as organic acids was reported more

effective in inhibiting *L. monocytogenes* and aerobic mesophilic bacteria (total viable count) than the chitosan coating alone.^{6,7,12}

Chitin, chitosan and their oligomers are known to possess excellent biological properties, especially antimicrobial activity.^{13,14} The use of chitosan as an edible coating on ready-to-eat food for inhibiting *L. monocytogenes* seems to be getting more attention recently than chitin.^{6,7,15} This is due to the significantly higher solubility of chitosan in organic acids, than crystalline chitin.¹⁶ The poor solubility of chitin in any solvent limits its potential application as an antimicrobial agent. More recently, water-soluble chitin oligomers (GlcNAc₁₋₁₀), composed of one to ten *N*-acetyl-D-glucosamine covalent β -(1 \rightarrow 4)-linkages, obtained either by acidic or enzymatic hydrolysis have been seen as simpler alternatives to the use of chitosan.^{14,17-21}

In this study, we aim to determine the effectiveness of the water-soluble chitin oligomer, *N,N'*-diacetylchitobiose (GlcNAc₂), as an antimicrobial coating on RTE shrimp. In addition to monitoring the inhibition of GlcNAc₂ against *L. monocytogenes*, this paper also reports on changes in physicochemical properties occurring during storage at 4 °C for 16 days.

2. Materials and methods

GlcNAc₂ was prepared as described by Abidin et al.²². Gram-positive bacterium *L. monocytogenes* 10403S was cultivated in-house (Department of Food and Nutritional Sciences, University of Reading, UK). All other reagents used in this study were of analytical grade and commercially available.

2.1 Ready-to-eat (RTE) shrimp preparation

Frozen headless and shell-less shrimps (*Litopenaeus Vannamei*) were purchased from a local retailer (Diamond Foods, UK). The shrimps were transported to the Pilot Plant (University of Reading, UK) immediately after purchased and stored at -18 °C. A day prior to the experiments, the shrimps were thawed overnight at 4 °C and cooked in boiling water for 2 min with a thermocouple inserted into the meat ensuring that the meat temperature must exceeded, 63 °C as recommended by U.S FDA for seafood. In fact, the actual cooking temperature of the shrimp meat was 92 °C at the end of the cooking process. After cooking, it was drained and cooled to dry.⁷ The samples were packed temporarily in the sterile bags prior to inoculation and coating with GlcNAc₂ on the same day the shrimps were cooked.

2.2 Inoculum and inoculation

L. monocytogenes 10403S was grown on Brain Heart Infusion agar (BHI) (Sigma Aldrich, UK) at 37 °C for 24 h. Agar plates were then stored at 4 °C for up to 3 weeks prior inoculum preparation. For the bacterial suspension preparation, 2-3 colonies were picked from the agar plate using a sterile plastic loop and transferred to sterile Tryptic Soy broth (TSB) under aseptic condition. The suspension was incubated at 37 °C for 16-18 h with continuous agitation.²² The suspension was then centrifuged at 7000 rpm for 15 min to separate the supernatant and cell pellet. The supernatant was discarded and the cell pellet was washed and resuspended in sterile 0.85% saline twice.¹ The optical density (OD) of the resuspension was then adjusted to 0.5 McFarland using a UV-Vis spectrophotometer (Orion AquaMate 8000, Thermo Scientific, UK) at 620 nm, which corresponds to approximately 1.5×10^8 CFU/mL. Then, the resuspension was diluted

with sterile 0.85% saline to give a final colony count of 1.5×10^5 CFU/mL and used as inoculum.

The RTE shrimp samples were inoculated by immersing them into the 1.5×10^5 CFU/mL *L. monocytogenes* inoculum at 20 °C for 5 min, with continuous agitation for bacterial attachment. After immersion, the samples were aseptically removed and allowed to drain on a sterile basket at 20 °C for 15 min.¹

2.3 Coating with GlcNAc₂

Coating solution of 1% (w/v) GlcNAc₂ was prepared by dissolving the compound in sterile deionised water. In this study, 1% (w/v) GlcNAc₂ concentration was chosen even though its MIC value was 10% (w/v) in order to prove the concept that it was effective. The inoculated and non-inoculated RTE shrimp samples were dipped in the treatment solution for 5 min. The coated samples were drained on the sterile basket and aseptically transferred into sterile Whirl-Pack® sample bags (Nasco, Fort Atkinson, WI), sealed and stored at 4 °C for 16 days. The control for this experiment included sets of inoculated and non-inoculated RTE shrimps that were dipped in separate sterile deionised water for the same dipping time as in the case of GlcNAc₂. The coating solutions were separate for the inoculated and non-inoculated RTE shrimp samples in order to avoid contamination with the bacteria strain.

The non-inoculated samples were analysed for texture, colour, lipid oxidation and moisture content, whereas the microbial analysis was conducted on the inoculated samples after 0, 4, 8, 12 and 16 days of storage at 4 °C.

2.4 Physicochemical analysis

2.4.1 Texture profile analysis (TPA)

The texture (hardness, cohesiveness, springiness and chewiness) of RTE shrimp samples was determined by texture profile analysis (TPA) with Texture Analyser CT3 Version 1.2 (Brookfield Engineering Laboratories, Middleboro, MA, USA) as described by Noordin *et al.*²³ and Yi *et al.*¹⁰. TPA was measured using a compression test with the texture analyser fitted with a cylindrical probe (6 mm in diameter) and 25-kg load cell moving at 1 mm/s test speed until the deformation was 70% of the original height.²³ Two measurements were taken at the second to third segment of the shrimp abdomen for each sample.²³ The texture of three shrimp samples were recorded, and these measurements were replicated thrice for each treatment.

2.4.2 Colour

Colour of the RTE shrimp was determined using a colour spectrophotometer (Minolta CR-400 chroma meter, Konica Minolta Sensing, Inc., Japan). L^* represented the brightness on a scale 0 (dark) to 100 (white), whereas a^* and b^* are negative to positive scale ranges between greenness to redness and blueness to yellowness, respectively.¹⁰ The measurements of surface colour were taken on both sides of the shrimp abdomen at the second and third segment and three shrimp samples were measured for each treatment. The colourimeter was calibrated with white tile, prior measurement.

2.4.3 Moisture content

The moisture content was determined according to the protocols recommended by AOAC (1990) by drying each sample in the oven at 105 °C until the sample weight became constant. The final moisture content was expressed on a wet weight basis.

2.4.4 Lipid peroxidation

The thiobarbituric-acid-reacting substances (TBARS) in the RTE shrimp samples were determined as described by Yi et al.¹⁰ with some modifications. The shrimp meat (1 g) was mixed with 9 mL of 0.25 N HCl containing 0.375% thiobarbituric acid (TBA) and 15% trichloroacetic acid (TCA). The mixture was heated in a boiling water bath for 10 min, giving a pink colour to the mixture, and followed by cooling with running water. The mixture was centrifuged (Centaur 2, MSE Sussex, UK) at 4000 rpm for 10 min and the supernatant was collected for measurement of absorbance at 532 nm using UV-Vis spectrophotometer (Cecil CE 7400, Cambridge, UK). The TBARS content were calculated from the standard curve of malonaldehyde (0 to 2 ppm) and expressed as mg malonaldehyde/kg shrimp meat.

2.5 Microbial analysis

Microbial analysis was done using the method described by Weerakkody et al.¹ with some modifications. The shrimp meat (10 g) was blended with 100 mL of 0.85% sterile saline solution in a Stomacher[®] strainer bag (Seward, Worthing, West Sussex, UK) and homogenised at normal speed for 2 min. Serial decimal dilutions of bacterial suspension were prepared with 0.85% sterile saline solution and 0.1 mL of each dilution was spread

onto PALCAM Listeria Selective Agar plate (Sigma Aldrich, UK) with PALCAM Listeria Selective Supplement (Sigma Aldrich, UK). The plate was incubated at 37 °C for 48 h, prior to enumeration. The results were expressed as the log CFU/g sample. Aerobic plate counts of the non-inoculated shrimp were analysed additionally to evaluate the effects of GlcNAc₂ on natural background microflora. Aerobic bacteria was enumerated by plating 0.1 mL on plate count agar (Sigma Aldrich, UK), which was incubated at 37 °C for 48 h.

2.6 Statistical analysis

Minitab® 18 (USA) statistical software was used for analysis of the difference in means by Tukey's multiple range test. The results were determined by one-way analysis of variance (ANOVA) at a significance level of 0.05 ($P < 0.05$). Three replicates were conducted for each physicochemical analysis, whereas the microbial analysis was run in duplicate for each treatment.

3. Results and discussions

3.1 Effect of GlcNAc₂ coating on the physicochemical properties of RTE shrimp

Texture profile analysis (TPA) is an instrumentally double compression test to measure textural properties of food.²⁴ Texture properties are the main quality attributes that assess the acceptability of the RTE shrimp. TPA was carried out to determine hardness, cohesiveness, springiness and chewiness indicating firmness, elasticity, stickiness and tenderness of the RTE shrimp meats, respectively.¹⁰ Based on TPA shown in Figure 4-1, the hardness and chewiness of the control sample increased significantly ($P < 0.05$) with

storage time (16 days), whereas no significant changes occurred in the case of GlcNAc₂-coated sample. In addition, the cohesiveness and springiness in all samples were maintained throughout the storage period lasting 16 days. The results obtained here were comparable with an earlier publication, which reported that the RTE shrimp meat, thermally processed at 85 °C for 30 min, became firmer and tender over 10 days of storage.¹⁰ The shrimp meat exposed to heat treatment above 70 °C developed hardening caused by proteins denaturation and shrinkage of collagen.^{25,26} The thermal shrinkage experienced in the early storage period, i.e in the first 10 days, resulted in a tightening and stiffening of the meat structure.¹⁰

Based on the results obtained, it was clarified that the cooking process employed enhanced the firmness and chewiness of the shrimp meat. In contrast, the presence of GlcNAc₂ coating prevented structure deformation. This finding is agreement with Wang *et al.*²⁷ and Yuan *et al.*²⁸ that the chitosan coating was reported effectively retarding the changes of texture parameters in shrimp during storage. The bonds between chitosan and myofibrillar proteins could be associated with the improvement of texture in shrimp muscle, with the final structure formed by both covalent and noncovalent interactions.²⁷ It is noteworthy that the texture of the RTE shrimp was maintained firmer without notable deterioration, regardless of treatment, throughout the storage period.

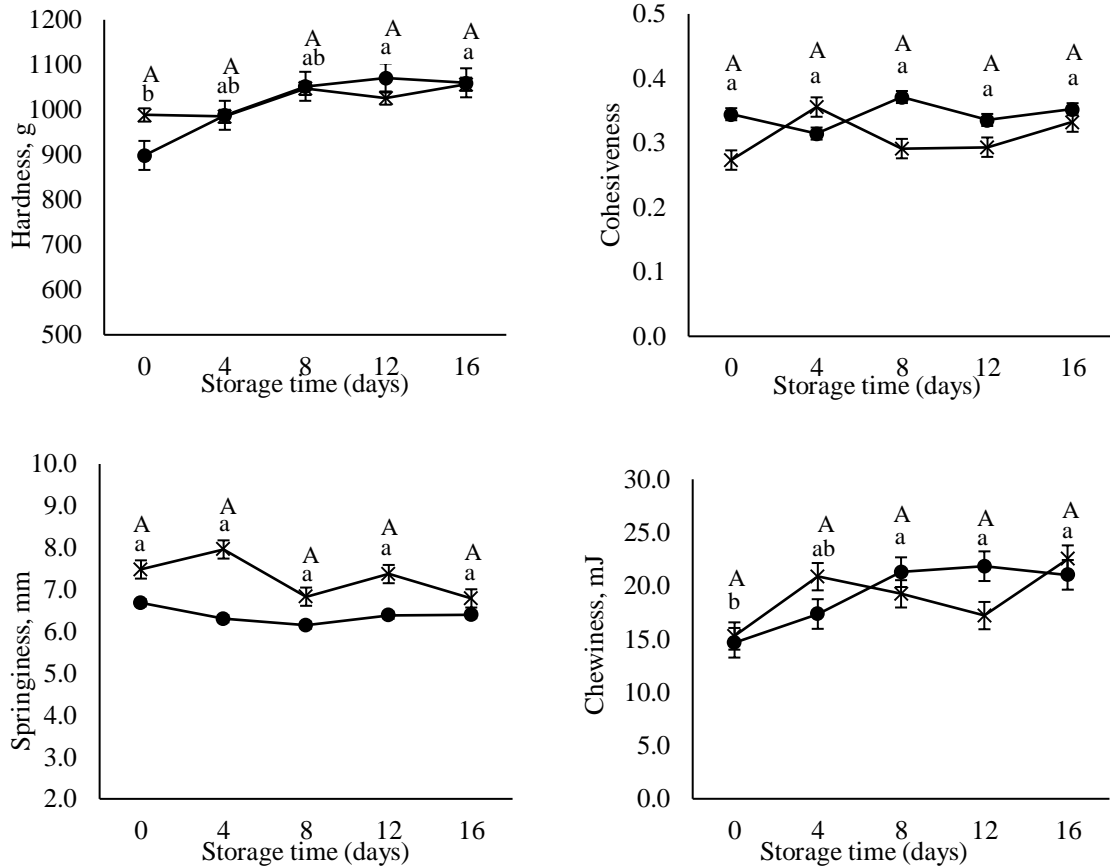

Figure 4-1. Changes in the TPA of control (●) and GlcNAc₂-coated (×) RTE shrimp occurring during 16 days of storage at 4 °C. Small and capital letters indicate significant differences ($P < 0.05$) of control and GlcNAc₂-coated samples during storage, respectively.

Colour is one of the main quality attributes of RTE products which critically influences consumer perception and purchasing decision. Brightness (L^*), redness (a^*) and yellowness (b^*) were recorded for the GlcNAc₂-coated and control samples (Table 4-1) showing significant changes occurring over 16 days of storage ($P < 0.05$). The values of L^* and b^* of the control and GlcNAc₂-coated samples increased ($P < 0.05$) from 47 and 46 to 60 and 57 and from -2 and -0.3 to 5.8 and 7.0, respectively. In contrast, the redness of the samples significantly decreased ($P < 0.05$) with storage. However, GlcNAc₂-coated sample did not show any significant change compared to the control sample.

Increase in the L^* and b^* of cooked shrimp has been previously discussed by Zhang et al.¹⁰, who attributed the increase to protein denaturation induced during sample heating. They reported that the brightness of cooked shrimp increases due to protein coagulation, thereby changing the shrimp surface properties, increasing light reflection and creating a whitened colour of the meat.¹⁰ As protein denaturation occurs, astaxanthin releases from carotenoproteins changing the colour from orange to red after heating.²⁹ However, degradation of astaxanthin continued when the redness values of RTE shrimp decreased throughout storage.

TBARS test uses the concentration of malonaldehyde as a marker of oxidative rancidity and is widely used for measuring lipid oxidation in meat, which can lead to the production of off-flavours and odours.^{30,31} The TBARS values shown in Figure 4-2 indicate lipid oxidation of the RTE shrimp occurring during storage. The TBARS value of GlcNAc₂-coated RTE shrimp was higher than control, whereas the TBARS value of the control sample increased sharply from 0.4 to 0.7 mg malonaldehyde/kg shrimp after 4 days storage and decreased significantly to 0.6 mg malonaldehyde/kg shrimp at day 8 and maintained this value until day 16. In general, the development of lipid oxidation in the RTE shrimp meat is influenced by several factors such as packaging, storage and other processing conditions.³² Thermal cooking is known to accelerate lipid peroxidation.³² The presence of oxygen during storage is also likely accelerate oxidative deterioration.⁹ In addition, chitosan is also reported to be a good barrier to oxygen permeation when it is applied on the surface of pink salmon.³³ From the findings here, it is clear that the GlcNAc₂ coating is also able to maintain lipid oxidation in the RTE shrimp meat, i.e no significant changes in the TBARS values were observed during storage, probably by a similar mechanism.

According to Cadun et al.³⁴, TBARS value for high quality food product must be less than 3 mg malonaldehyde/kg. Based on this criteria, all the RTE shrimp samples studied here, regardless of the presence of GlcNAc₂, could be considered to be “high-quality product” as the TBARS values of the samples were less than 3 mg malonaldehyde/kg even after 16 days of storage.

Table 4-1. Changes in surface colour of control and GlcNAc₂-coated samples during 16 days of storage at 4 °C.

| Treatments | Day 0 | Day 4 | Day 8 | Day 12 | Day 16 |
|-----------------------------|----------------|--------------|---------------|--------------|--------------|
| Brightness, <i>L</i> * | | | | | |
| Control | 47.38±6.46 b** | 46.81±5.15 b | 48.66±5.11 b | 47.78±5.37 b | 60.18±8.38 a |
| GlcNAc ₂ -coated | 46.21±3.24c | 52.57±1.64 b | 55.12±3.51 ab | 57.01±3.75 a | 57.11±3.12 a |
| Redness, <i>a</i> * | | | | | |
| Control | 3.63±1.16 a | 3.01±1.82 a | 2.87±1.78 a | 2.93±1.95 a | -1.79±1.72 b |
| GlcNAc ₂ -coated | 2.85±1.35 a | -1.88±0.66 c | 0.72±0.86 b | -2.34±0.78 c | -2.55±0.83 c |
| Yellowness, <i>b</i> * | | | | | |
| Control | -2.02±3.00 b | -1.81±3.04 b | -1.98±3.31 b | -3.16±4.16 b | 5.83±4.46 a |
| GlcNAc ₂ -coated | -0.25±1.25 d | 4.47±2.02 b | 1.90±2.15 c | 6.66±2.32 a | 7.05±2.00 a |

** Different letters in each row indicate significant differences ($P < 0.05$) during storage.

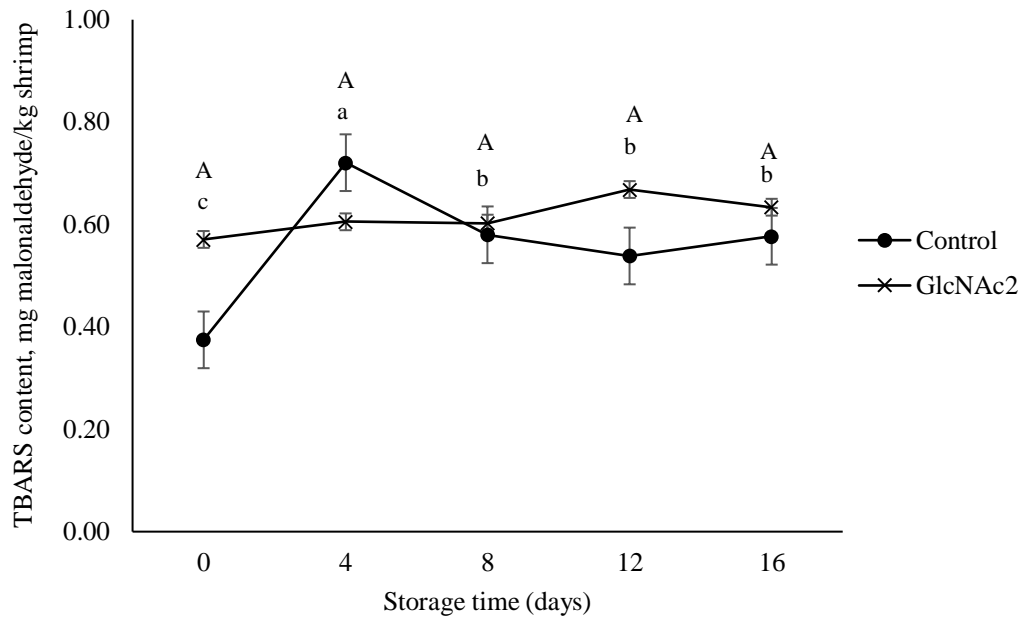

Figure 4-2 . TBARS values for control and GlcNAc₂-coated RTE shrimp during 16 days of storage at 4 °C. Small and capital letters indicate significant differences ($P<0.05$) of control and GlcNAc₂-coated samples during storage, respectively.

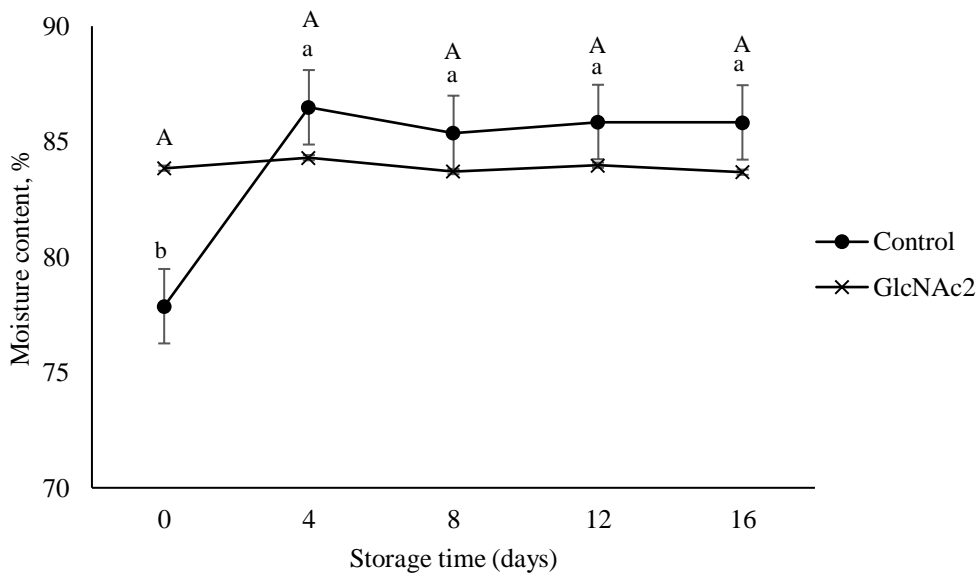

Figure 4-3. Moisture content changes in control and GlcNAc₂-coated RTE shrimp during 16 days of storage at 4 °C. Small and capital letters indicate significant differences ($P<0.05$) of control and GlcNAc₂-coated samples during storage, respectively.

Moisture has been reported to be the most important property of RTE shrimp affecting quality, stability and safety during storage.¹⁰ The moisture content of the control sample shown in Figure 4-3 increased sharply ($P<0.05$) from 78% at the start of storage to 86% on day 4 due to moisture absorption capability of the sample. The moisture contents of the control sample then remained constant at approximately 86%, until end of the storage period. Employing GlcNAc₂, on the other hand, retained moisture and the moisture content remained constant at 84% throughout storage. The stability of moisture content of the RTE shrimp may be due to the GlcNAc₂ layer acting as a protective barrier against moisture escape. Previously, Butler et al.³⁰ also reported that chitosan coating acted as a protective barrier against moisture loss.

3.2 Effect of GlcNAc₂ coating on the RTE shrimp inoculated by *L. monocytogenes*

In this study, aerobic bacteria did not grow on the samples during storage (data not shown). *L. monocytogenes* counts on the inoculated shrimp were initially 2 log CFU/mL. The growth showed no significant differences between samples until day 8 of storage. However, a significant lower growth ($P<0.05$) of *L. monocytogenes* in GlcNAc₂-coated samples was detected on day 12, with the highest log reduction of 0.5 log CFU/mL being observed, as shown in Figure 4-4. On day 16, the growth on the GlcNAc₂-coated sample approached similar colony counts as the control.

The application of chitin and its oligomers as antimicrobial coating for RTE foods is not widespread due to low solubility and availability, respectively. Therefore, chitosan, a chitin derivative, is used against *L. monocytogenes*. Based on earlier research, chitosan either acid-soluble or water-soluble oligomers has been used successfully against the growth of listeria in inoculated samples of raw and RTE shrimp.^{6,7,32} According to Alfaro

et al.³², the increase in concentration of water-soluble chitosan from 0.5 to 5% significantly ($P<0.05$) increased the antimicrobial activity by lowering counts by 7.43 log CFU/g. In another related study, the count of *L. innocua* inoculated on the RTE shrimp was reduced by 2.29 log CFU/g after treating with 2% chitosan in combination with 2% organic acid.⁶ In a similar work reported by Li et al.⁷, 1% chitosan incorporation in 2% organic acid was the most effective treatment against *L. monocytogenes* inoculated on the RTE shrimp, which caused a 5.38-log CFU/g bacterial reduction. It is most likely that the mechanism of action of GlcNAc₂ is not very different from chitosan and a precipitate on the microbial cell surface forms an impervious layer around the cell thereby blocking the channels to transport essential solutes crucial for cell survival.³³ The impervious layer can also destabilise the cell wall beyond repair.³³

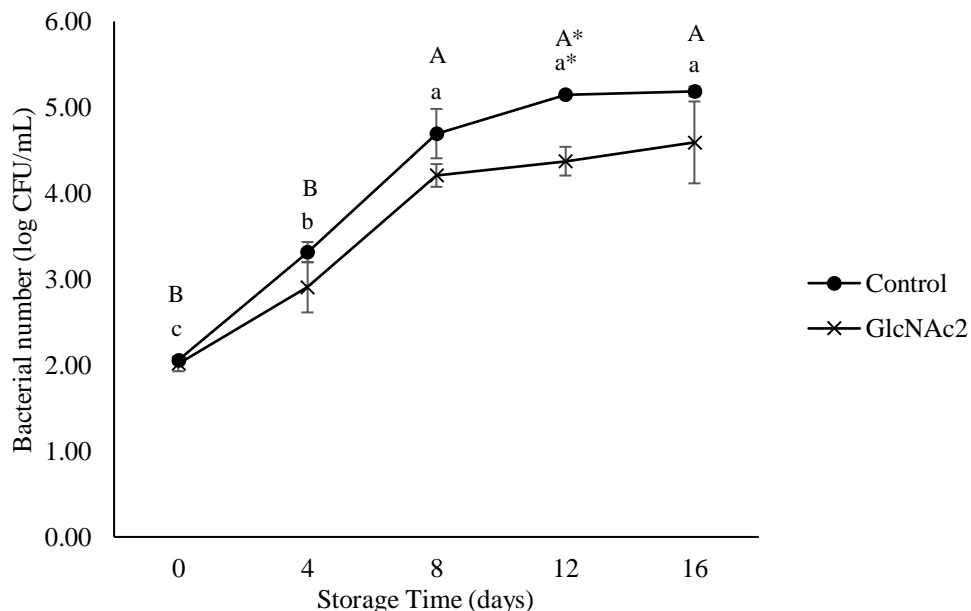

Figure 4-4. Growth of *L. monocytogenes* in control and GlcNAc₂-coated RTE shrimp during 16 days of storage at 4 °C. Small and capital letters indicate significant differences ($P<0.05$) of control and GlcNAc₂-coated samples during storage, respectively. Asterisk (*) indicates significant differences ($P<0.05$) between samples over storage time.

4. Conclusion

The results demonstrated that 1% (w/v) GlcNAc₂ coating retarded the changes in texture properties, TBARS values and moisture content of the RTE shrimp during 16-day storage at 4 °C. GlcNAc₂ coating showed an inhibition against *L. monocytogenes* only up to day 12 of storage, with a net log reduction of 0.5 log CFU/mL. Furthermore, the absence or presence of GlcNAc₂ did not influence colour changes in shrimp meat.

References

1. Weerakkody NS, Caffin N, Dykes GA, Turner MS, Effect of antimicrobial spice and herb extract combinations on *Listeria monocytogenes*, *Staphylococcus aureus*, and spoilage microflora growth on cooked ready-to-eat vacuum-packaged shrimp. *J Food Prot* **74**:1119–1125 (2011).
2. Lin L, Wang SF, Yang TY, Hung WC, Chan MY, Tseng SP, Antimicrobial resistance and genetic diversity in ceftazidime non-susceptible bacterial pathogens from ready-to-eat street foods in three Taiwanese cities. *Sci Rep* **7**:1–10 (2017).
3. Buchanan RL, Microbiological criteria for cooked , ready-to-eat shrimp and crabmeat. *Food Technol* **45**:157–160 (1991).
4. Kanatt SR, Rao MS, Chawla SP, Sharma A, Effects of chitosan coating on shelf-life of ready-to-cook meat products during chilled storage. *LWT - Food Sci Technol* **53**:321–326 (2013).
5. Rutherford TJ, Marshall DL, Andrews LS, Coggins PC, Schilling MW, Gerard P, Combined effect of packaging atmosphere and storage temperature on growth of *Listeria monocytogenes* on ready-to-eat shrimp. *Food Microbiol* **24**:703–710 (2007).
6. Guo M, Jin TZ, Scullen OJ, Sommers CH, Effects of antimicrobial coatings and cryogenic freezing on survival and growth of *Listeria innocua* on frozen ready-to-eat shrimp during thawing. *J Food Sci* **78**:M1195–200 (2013).
7. Li M, Wang W, Fang W, Li Y, Inhibitory effects of chitosan coating combined with organic acids on *Listeria monocytogenes* in refrigerated ready-to-eat shrimps. *J Food Prot* **76**:1377–1383 (2013).
8. Mejlholm O, Bøknæs N, Dalgaard P, Shelf life and safety aspects of chilled cooked and peeled shrimps (*Pandalus borealis*) in modified atmosphere packaging. *J Appl Microbiol* **99**:66–76 (2005).
9. Kanatt SR, Chawla SP, Chander RÃ, Sharma A, Development of shelf-stable , ready-to-eat (RTE) shrimps (*Penaeus indicus*) using g -radiation as one of the hurdles. *LWT - Food Sci Technol* **39**:621–626 (2006).
10. Yi J, Zhang L, Ding G, Hu X, Liao X, Zhang Y, High hydrostatic pressure and thermal treatments for ready-to-eat wine-marinated shrimp: An evaluation of microbiological and physicochemical qualities. *Innov Food Sci Emerg Technol* **20**:16–23 (2013).
11. Mahmoud BSM, Effect of X-ray treatments on inoculated *Escherichia coli* O157 : H7, *Salmonella enterica*, *Shigella flexneri* and *Vibrio parahaemolyticus* in ready-to-eat shrimp. *Food Microbiol* **26**:860–864 (2009).
12. Carrión-granda X, Fernández-pan I, Jaime I, Rovira J, Maté JI, Improvement of the microbiological quality of ready-to-eat peeled shrimps (*Penaeus vannamei*) by the use of chitosan coatings. *Int J Food Microbiol* **232**:144–149 (2016).

13. Abidin MZ, Junqueira-Gonçalves MP, Khutoryanskiy VV, Niranjana K, Intensifying chitin hydrolysis by adjunct treatments – an overview. *J Chem Technol Biotechnol* **92**:2787–2798 (2017).
14. Osada M, Miura C, Nakagawa YS, Kaihara M, Nikaido M, Totani K, Effect of sub- and supercritical water pretreatment on enzymatic degradation of chitin. *Carbohydr Polym* **88**:308–312 (2012).
15. Guo M, Jin TZ, Wang L, Scullen OJ, Sommers CH, Antimicrobial films and coatings for inactivation of *Listeria innocua* on ready-to-eat deli turkey meat. *Food Control* **40**:64–70 (2014).
16. Rinaudo M, Chitin and chitosan: Properties and applications. *Prog Polym Sci* **31**:603–632 (2006).
17. Roy I, Mondal K, Gupta MN, Accelerating enzymatic hydrolysis of chitin by microwave pretreatment. *Biotechnol Prog* **19**:1648–1653 (2003).
18. Benhabiles MS, Salah R, Lounici H, Drouiche N, Goosen MFA, Mameri N, Antibacterial activity of chitin, chitosan and its oligomers prepared from shrimp shell waste. *Food Hydrocoll* **29**:48–56 (2012).
19. Trombotto S, Ladavière C, Delolme F, Domard A, Chemical preparation and structural characterization of a homogeneous series of chitin/chitosan oligomers. *Biomacromolecules* **9**:1731–1738 (2008).
20. Dziril M, Grib H, Laribi-Habchi H, Drouiche N, Abdi N, Lounici H, Pauss A, Mameri N, Chitin oligomers and monomers production by coupling γ radiation and enzymatic hydrolysis. *J Ind Eng Chem* **26**:396–401 (2015).
21. Villa-Lerma G, González-Márquez H, Gimeno M, Trombotto S, David L, Ifuku S, Shirai K, Enzymatic hydrolysis of chitin pretreated by rapid depressurization from supercritical 1,1,1,2-tetrafluoroethane toward highly acetylated oligosaccharides. *Bioresour Technol* **209**:180–186 (2016).
22. Abidin MZ, Kourmentza C, Karatzas AK, Niranjana K, Enzymatic hydrolysis of thermally pre-treated chitin and antimicrobial activity of *N,N'*-diacetylchitobiose. *J Chem Technol Biotechnol* (2019). <https://doi.org/10.1002/jctb.6043>
23. Noordin WNM, Shunmugam N, Huda N, Adzitey F, The effects of essential oils and organic acids on microbiological and physicochemical properties of whole shrimps at refrigerated storage. *Curr Res Nutr Food Sci* **06**:273–283 (2018).
24. Chen L, Linus U, Texture measurement approaches in fresh and processed foods — A review. *Food Res Int* **51**:823–835 (2013).
25. Benjakul S, Visessanguan W, Kijroongrojana K, Sriket P, Effect of heating on physical properties and microstructure of black tiger shrimp (*Penaeus monodon*) and white shrimp (*Penaeus vannamei*) meats. *Int J Food Sci Technol* **43**:1066–1072 (2008).
26. Mizuta S, Yamada Y, Miyagi T, Yoshinaka R, Histological changes in collagen related to textural development of prawn meat during heat processing. *J Food Sci* **64**:991–995 (1999).

27. Wang Y, Liu L, Zhou J, Ruan X, Lin J, Fu L, Effect of chitosan nanoparticle coatings on the quality changes of postharvest whiteleg shrimp, *Litopenaeus vannamei*, during storage at 4 °C. *Food Bioprocess Technol* **8**:907–915 (2015).
28. Yuan G, Lv H, Tang W, Zhang X, Sun H, Effect of chitosan coating combined with pomegranate peel extract on the quality of Pacific white shrimp during iced storage. *Food Control* **59**:818–823 (2016).
29. Tume RK, Sikes AL, Tabrett S, Smith DM, Effect of background colour on the distribution of astaxanthin in black tiger prawn (*Penaeus monodon*): Effective method for improvement of cooked colour. *Aquaculture* **296**:129–135 (2009).
30. Butler BL, Vergano PJ, Testin RF, Bunn JM, Wiles JL, Mechanical and barrier properties of edible chitosan films as affected by composition and storage. *J Food Sci* **61**:953–956 (1996).
31. Sathivel S, Liu Q, Huang J, Prinyawiwatkul W, The influence of chitosan glazing on the quality of skinless pink salmon (*Oncorhynchus gorbuscha*) fillets during frozen storage. *J Food Eng* **83**:366–373 (2007).
32. Alfaro L, Chotiko A, Chouljenko A, Janes M, King JM, Sathivel S, Development of water-soluble chitosan powder and its antimicrobial effect against inoculated *Listeria innocua* NRRL B-33016 on shrimp. *Food Control* **85**:453–458 (2018).
33. Qin C, Li H, Xiao Q, Liu Y, Zhu J, Du Y, Water-solubility of chitosan and its antimicrobial activity. *Carbohydr Polym* **63**:367–374(2006).
34. Cadun A, Kıs D, Şükran Ç, Marination of deep-water pink shrimp with rosemary extract and the determination of its shelf-life. *Food Chem* **109**:81–87 (2008).

Chapter 5 : Concluding remarks and recommendations for future work

1. Key conclusions

The thermal pre-treatment of chitin in an autoclave was found to be an effective method for structure modification, and the best operating conditions involved heating at 121 °C for 60 min, prior to hydrolysis. Autoclaving modified the chitin structure by swelling and partial degradation. The crystallinity of the chitin was maintained after autoclaving, whereas some deacetylation occurred. In this study, the deacetylation was kept to a minimum by restricting autoclaving times to a maximum of 60 min; this time also gave an adequate yield of oligomers, mainly dimer (GlcNAc₂) and a very small amount of monomer, after hydrolysis with chitinase from *Streptomyces griseus*. It has been suggested that the hydrolysis occurred by the following steps: (1) random cleaving to form the intermediate oligomers, i.e trimer (GlcNAc₃) and tetramer (GlcNAc₄) and (b) breaking down of the intermediate oligomers into GlcNAc and GlcNAc₂ as final product. The yield of GlcNAc₂ obtained after hydrolysis of autoclaved chitin reached maximum after 24 h, whereas an extra 12 h, i.e. a total of 36 h, was required for completing the hydrolysis of the control sample, showing that the proposed condition for pre-treatment (at 121 °C for 60 min) accelerated the enzymatic reaction. The GlcNAc₂ produced exhibited strong antimicrobial activity against *E. coli* and *L. monocytogenes*, showing MIC values of 5 and 10% (w/v), respectively, using media as the solvent.

In a further study, GlcNAc₂ was used as an antimicrobial coating on ready-to-eat (RTE) shrimp (cooked) for observing microbial inhibition and changes occurring in its quality. Due to the higher cost of commercial chitinase, which limits the production of GlcNAc₂, the MIC of 10% (w/v) obtained in the previous chapter has been scaled down to 1% (w/v).

The 1% (w/v) GlcNAc₂ solution developed a protective layer on the surface of the RTE shrimp and retarded changes in textural properties, TBARS values and moisture content over 16-day storage at 4 °C. The GlcNAc₂ coating exhibited inhibitory effects against *L. monocytogenes* when the growth of the inoculated RTE shrimp was lower than control on day 12 of storage with the highest log reduction of 0.5 log CFU/mL being noted. However, no significant differences was observed between the GlcNAc₂ coated and uncoated samples.

Overall, the thermal pre-treatment of chitin in an autoclave, which is a method that has never been reported earlier, was able to modify the chitin structure, and accelerate the enzymatic hydrolysis to produce GlcNAc₂. The reported MIC values of the GlcNAc₂ indicates that the compound possesses effective antimicrobial activity against *E. coli* and *L. monocytogenes*. The inhibitory effects of GlcNAc₂ was also noted in a real food system (RTE shrimp) where it inhibited the growth of inoculated *L. monocytogenes*. In addition, GlcNAc₂ also showed a similar inhibitory effect as compared to other antimicrobial agent isolated from natural sources, such as essential oils from plant, peptides including nisin isolated from lactic acid bacteria and lipids. The mechanism of action of these antimicrobial agents has been shown to occur mainly by the disruption of bacterial cell wall or membrane.

2. Recommendations for future work

1. Thermal pre-treatment of the chitin by using an autoclave effectively modified the substrate structure and accelerated subsequent enzymatic reaction. However, the yield of GlcNAc₂ obtained from the pre-treated substrate was similar to the untreated sample. It would be worth combining autoclaving with other mechanical treatments such as grinding with a ball mill in order to decrease the particle size and increase the breakage of chitin crystal structure. This approach is likely to increase the yield of the GlcNAc₂ during hydrolysis.

2. GlcNAc₂ was the main compound produced by the hydrolysis of thermally pre-treated chitin with chitinase from *Streptomyces griseus*. It would be worth employing chitinase from other sources, such as fungus *Lecanicillium lecanii* and bacterial strain *Bacillus cereus* TKU027, which may produce higher oligomers GlcNAc₂₋₉, which may result in superior inhibitory effect against Gram-negative and Gram-positive strains. This approach is worth exploring further.

3. In this study, a high concentration of GlcNAc₂ was required to achieve MIC. Combination of GlcNAc₂ with organic acids, such as acetic acid, can synergise the antimicrobial activity and is worth trying.

4. The application of 1% (w/v) GlcNAc₂ as coating solution showed low log reduction of *L. monocytogenes* inoculated on the RTE shrimp. It would be worth incorporating GlcNAc₂ coating with other natural antimicrobial agents, for instance, potent plant extracts to achieve better inhibition.

Appendices

Appendix 1. Part of the literature review (Chapter 2) in this thesis has been published as “Abidin MZ, Junqueira-Gonçalves MP, Khutoryanskiy VV, Niranjana K, Intensifying chitin hydrolysis by adjunct treatments – an overview. *J Chem Technol Biotechnol* **92**: 2787–2798 (2017).”

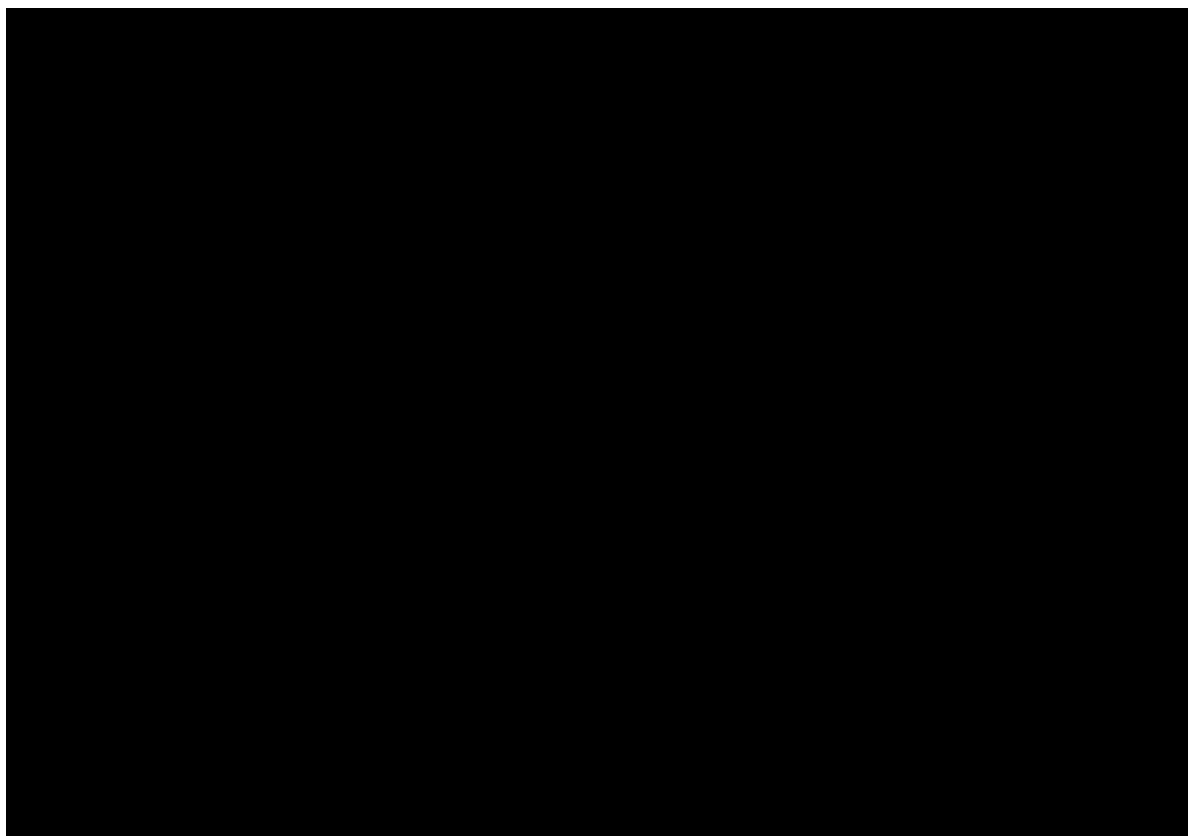

Appendix 2. Chapter 3 of this thesis has been published as “Abidin MZ, Kourmentza C, Karatzas K, Niranjana K, Enzymatic hydrolysis of thermally pre-treated chitin and antimicrobial activity of *N,N'*-diacetylchitobiose. *J Chem Technol Biotechnol* **94**: 2529-2536 (2019).”

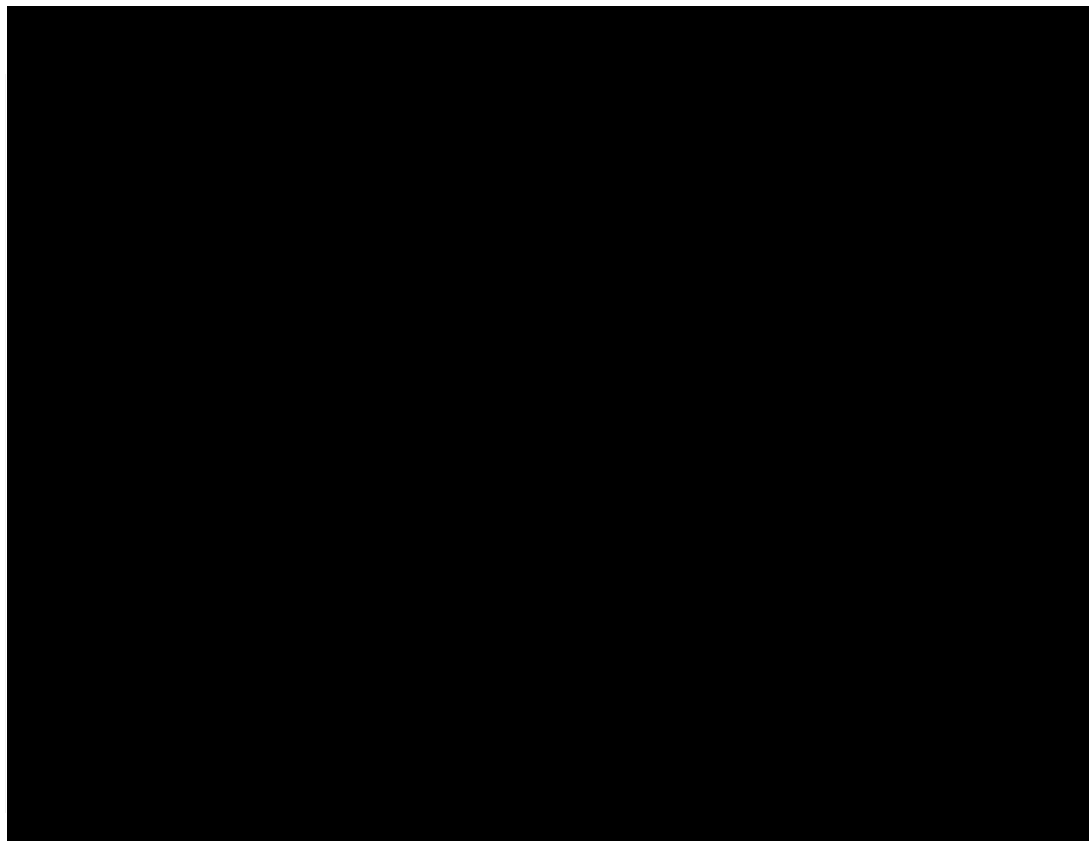

Appendix 3. Acceptance letter for a poster presentation in Food Innovation Asia Conference, 14-16 June 2018, Bangkok, Thailand.

Accepted (FIAC2018)

Secretariat steering committee [REDACTED]

Fri 23/03/2018 23:40

To: Munira Zainal Abidin [REDACTED]

Dear (Mrs. Munira Zainal Abidin)

Ref No. BPB92

Topic: Intensification of the enzymatic hydrolysis of chitin by thermal pre-treatment in an autoclave

Category: Division (B) Food Processing and Engineering

Type: Poster - Book of abstract

The review of your abstract has been completed. We are pleased to inform you that your abstract has been **accepted** for poster presentation at the Food Innovation Asia Conference 2018 to be held with the ProPak Asia 2018, at Bangkok International Trade & Exhibition Centre (BITEC), Bangkok, Thailand during 14-16 June 2018.

Poster sessions will be located on the 2nd floor at BITEC. A 90 (width) x 120 (height) cm partition board will be provided for your poster exhibition. Your poster board will be marked with your poster number. Detailed schedule of the poster sessions will be announced later at the conference website.